

N-Channel Logic Level Enhancement Mode MOSFET

MTN7002KC3

BV _{DSS}	60V
I _D	230mA
R _{DS(on)} @V _{GS} =10V	1.2Ω typ.
R _{DS(on)} @V _{GS} =4.5V	1.8Ω typ.

Description

The MTN7002KC3 is a N-channel enhancement-mode MOSFET.

Features

- Low on-resistance
- High ESD
- High speed switching
- Low-voltage drive
- Easily designed drive circuits
- Easy to use in parallel
- Pb-free package

Symbol

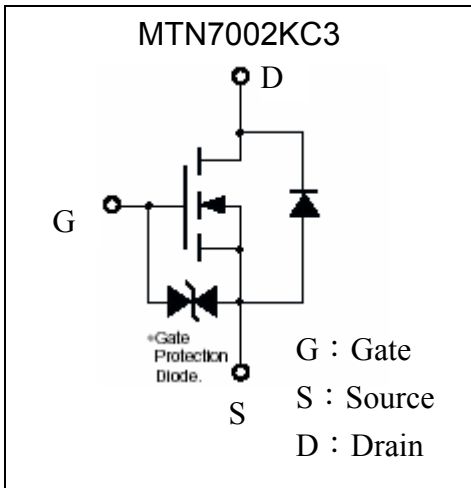

Outline

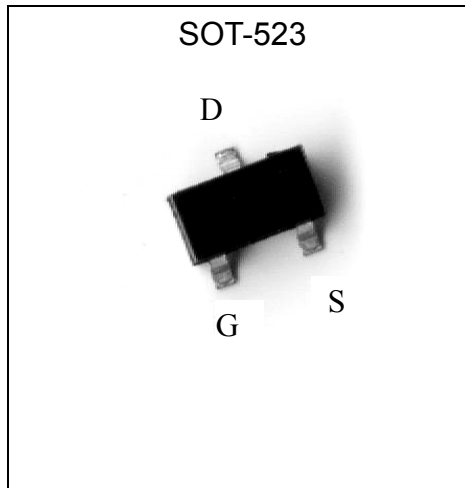

Ordering Information

Device	Package	Shipping	Marking
MTN7002KC3	SOT-523 (Pb-free)	3000 pcs / Tape & Reel	72



Absolute Maximum Ratings (Ta=25°C)

Parameter		Symbol	Limits	Unit
Drain-Source Voltage		V _{DSS}	60	V
Gate-Source Voltage		V _{GSS}	±20	V
Drain Current	Continuous	I _D	230	mA
	Pulsed	I _{DP}	800 *1	mA
Drain Reverse Current	Continuous	I _{DR}	230	mA
	Pulsed	I _{DRP}	800 *1	mA
Total Power Dissipation		P _D	150 *2	mW
ESD susceptibility			1550 *3	V
Channel Temperature		T _{CH}	+150	°C
Storage Temperature		T _{stg}	-55~+150	°C

Thermal Characteristics

Parameter	Symbol	Value	Unit
Thermal Resistance, Junction to Ambient	R _{θJA}	833 *2	°C/W

Note : *1. Pulse Width ≤ 300μs, Duty cycle ≤ 2%

*2. When the device is mounted on a glass epoxy board with area measuring 1×0.75×0.62 inch

*3. Human body model, 1.5kΩ in series with 100pF

Electrical Characteristics (Ta=25°C)

Symbol	Min.	Typ.	Max.	Unit	Test Conditions
BV _{DSS} *	60	-	-	V	V _{GS} =0, I _D =10μA
V _{GS(th)}	1	1.6	2.5		V _{DS} =V _{GS} , I _D =250μA
I _{GSS}	-	-	±10	μA	V _{GS} =±20V, V _{DS} =0
I _{DSS}	-	-	1		V _{DS} =60V, V _{GS} =0
R _{DS(ON)} *	-	1.2	2.5	Ω	I _D =500mA, V _{GS} =10V
	-	1.8	3		I _D =100mA, V _{GS} =4.5V
G _{FS}	100	240	-	mS	V _{DS} =10V, I _D =100mA
C _{iss}	-	30.6	-	pF	V _{DS} =10V, V _{GS} =0, f=1MHz
C _{oss}	-	5.5	-		
C _{rss}	-	4	-		
t _{d(ON)}	-	3	-	ns	V _{DS} =30V, I _D =200mA, V _{GS} =10V, R _G =6Ω
t _r	-	5	-		
t _{d(OFF)}	-	14	-		
t _f	-	9	-		
Q _g	-	1.1	-	nC	V _{DS} =30V, I _D =200mA, V _{GS} =10V
Q _{gs}	-	0.1	-		
Q _{gd}	-	0.23	-		

*Pulse Test : Pulse Width ≤ 300μs, Duty Cycle ≤ 2%

Typical Characteristics

Typical Output Characteristics

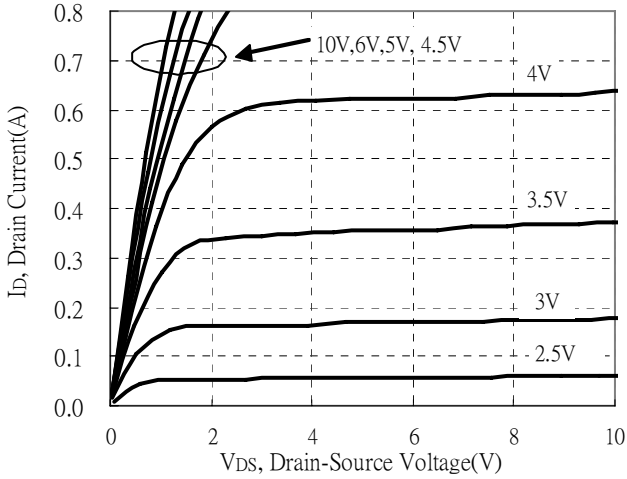

Typical Transfer Characteristics

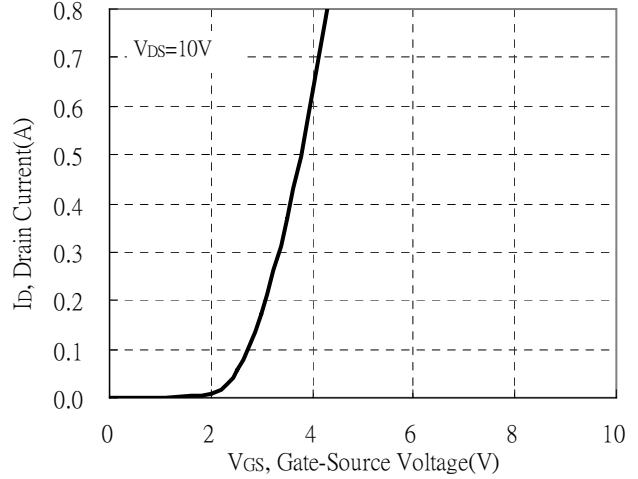

Static Drain-Source On-State resistance vs Drain Current

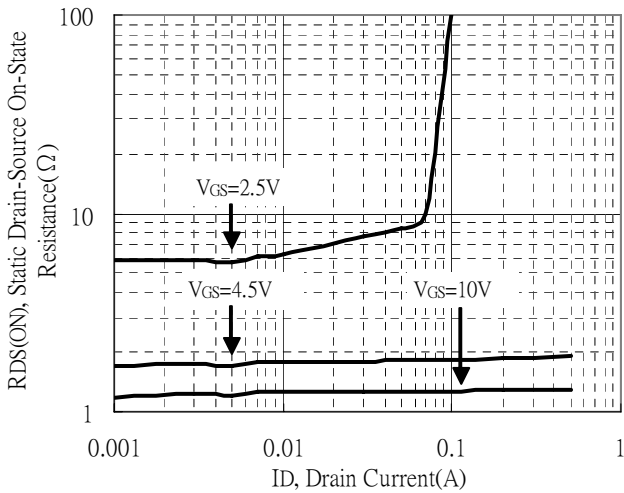

Reverse Drain Current vs Source-Drain Voltage

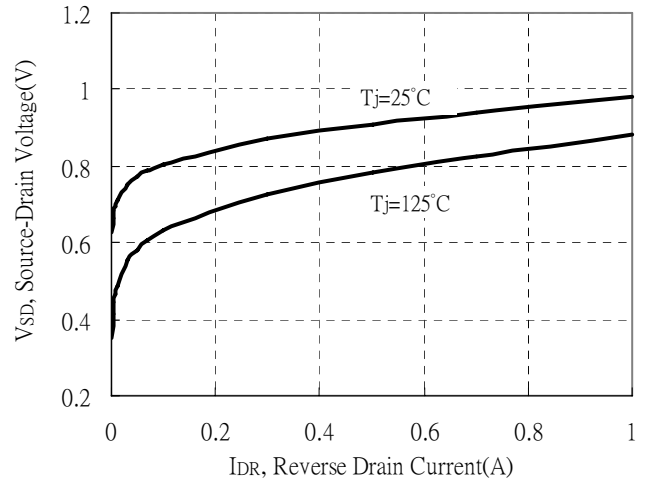

Static Drain-Source On-State Resistance vs Gate-Source Voltage

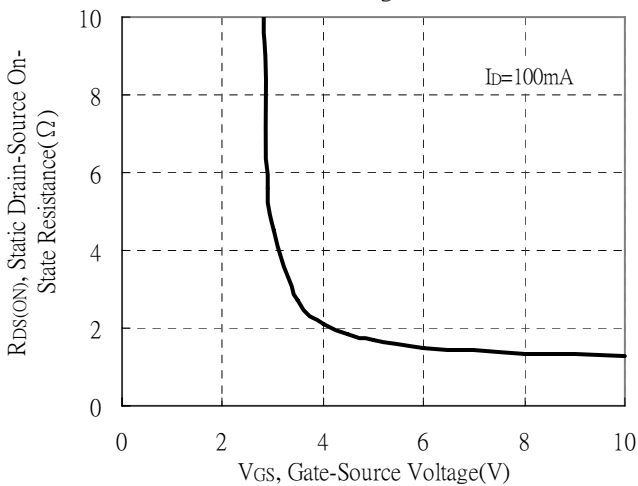

Drain-Source On-State Resistance vs Junction Temperature

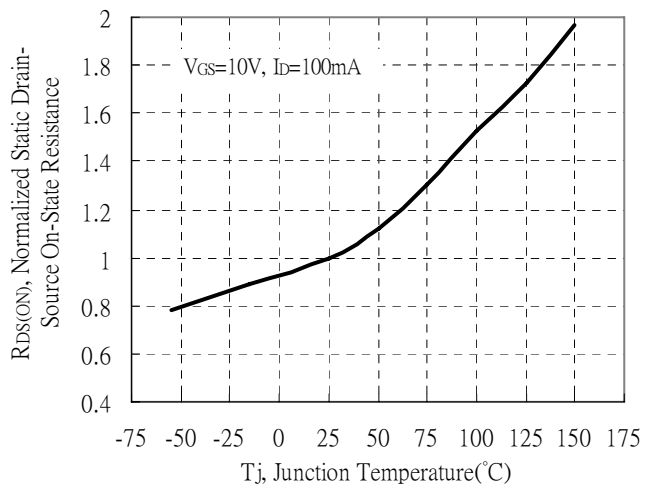



Typical Characteristics(Cont.)

Capacitance vs Drain-to-Source Voltage

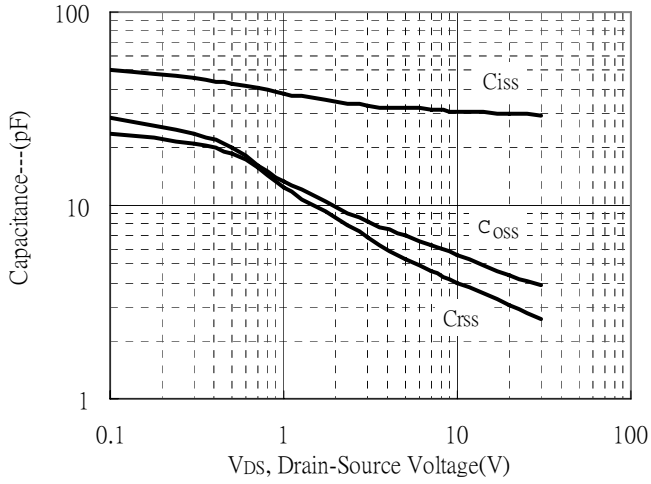

Threshold Voltage vs Junction Temperature

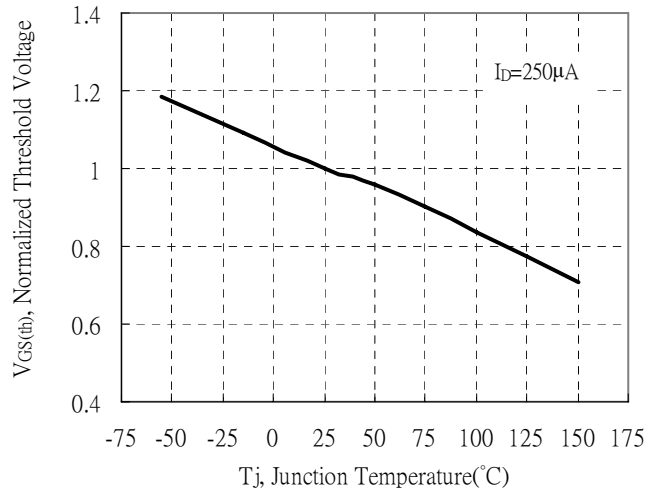

Power Derating Curve

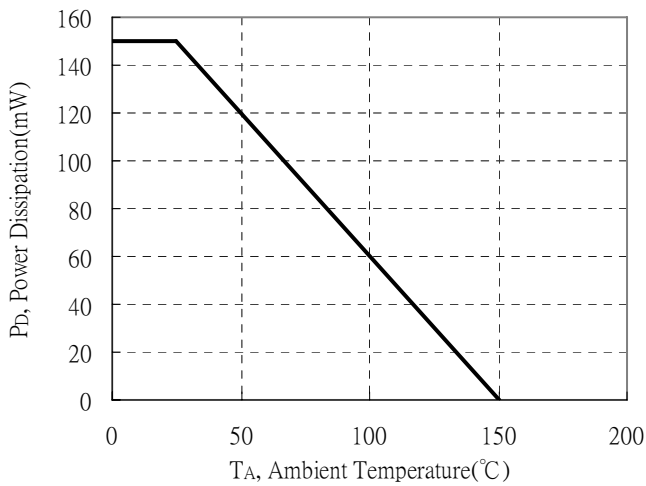

Maximum Drain Current vs Junction Temperature

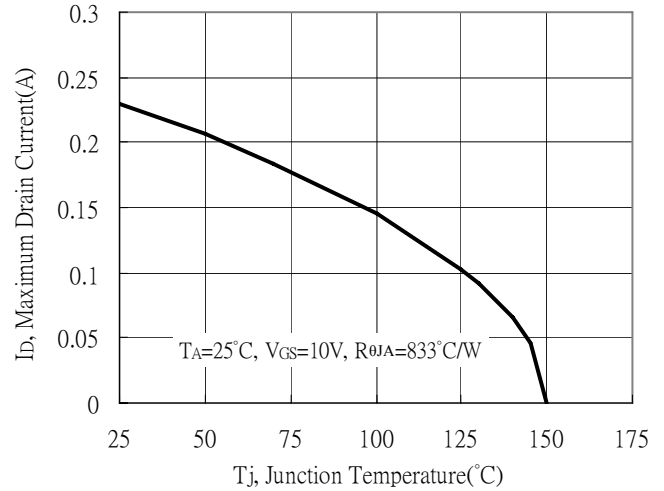

Reel Dimension

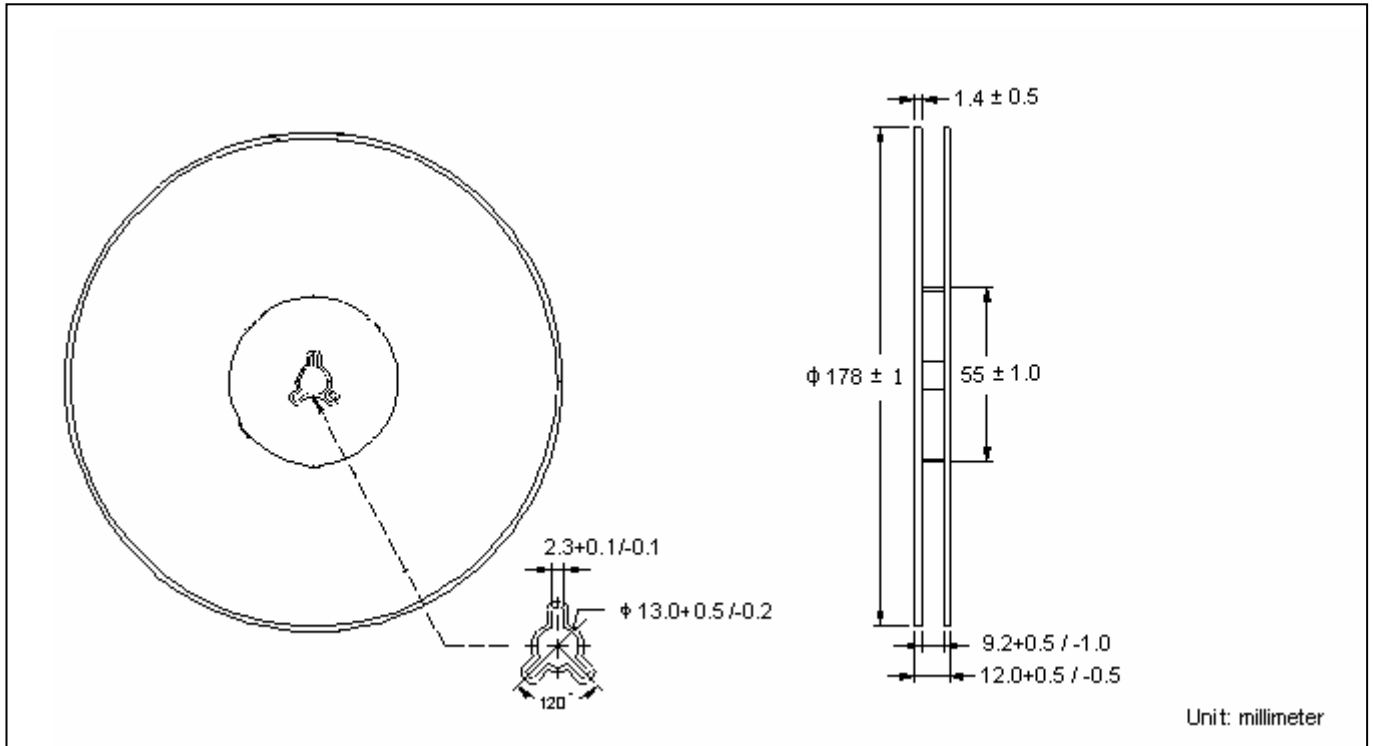

Carrier Tape Dimension

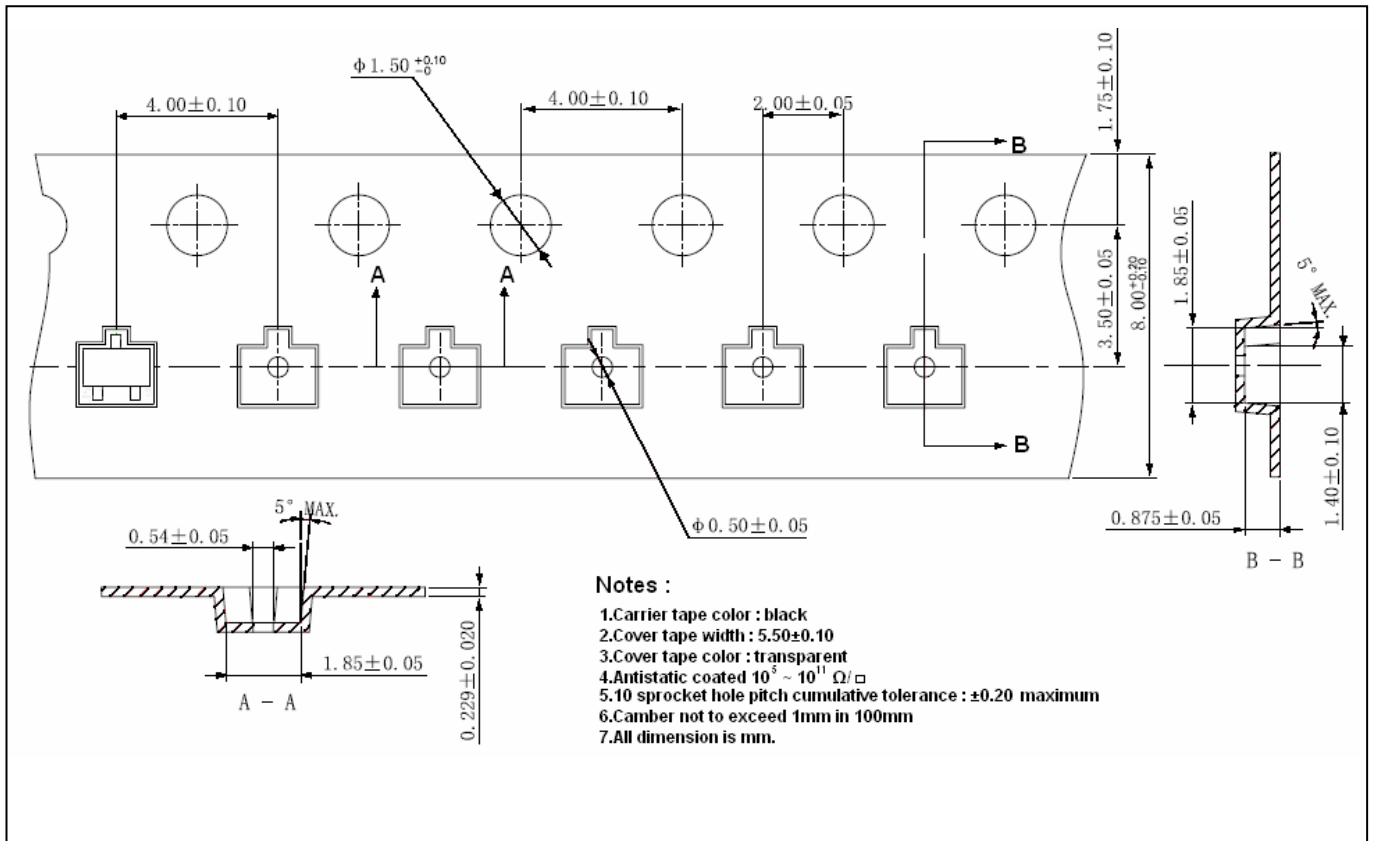

Recommended wave soldering condition

Product	Peak Temperature	Soldering Time
Pb-free devices	260 +0/-5 °C	5 +1/-1 seconds

Recommended temperature profile for IR reflow

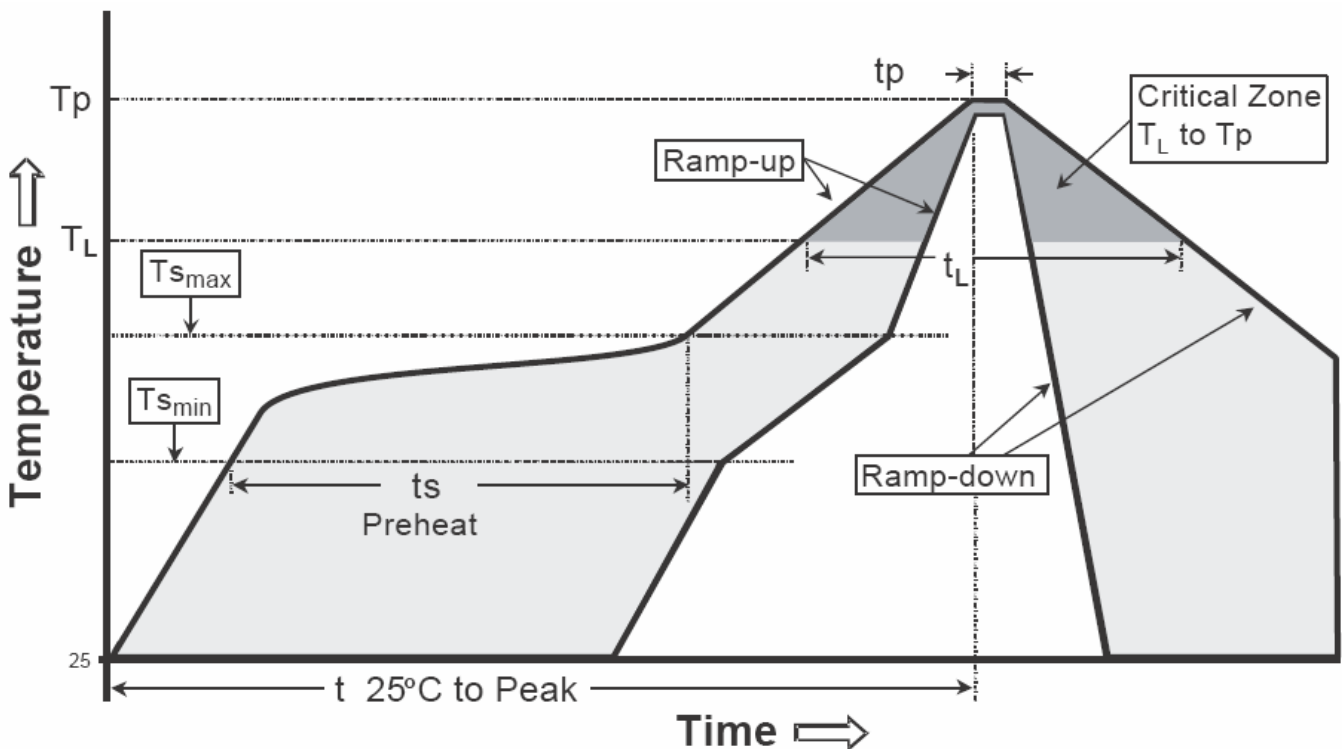

Profile feature	Sn-Pb eutectic Assembly	Pb-free Assembly
Average ramp-up rate (Ts _{max} to T _p)	3°C/second max.	3°C/second max.
Preheat		
-Temperature Min(T _s min)	100°C	150°C
-Temperature Max(T _s max)	150°C	200°C
-Time(t _s min to t _s max)	60-120 seconds	60-180 seconds
Time maintained above:		
-Temperature (T _L)	183°C	217°C
- Time (t _L)	60-150 seconds	60-150 seconds
Peak Temperature(T _p)	240 +0/-5 °C	260 +0/-5 °C
Time within 5°C of actual peak temperature(t _p)	10-30 seconds	20-40 seconds
Ramp down rate	6°C/second max.	6°C/second max.
Time 25 °C to peak temperature	6 minutes max.	8 minutes max.

Note : All temperatures refer to topside of the package, measured on the package body surface.

SOT-523 Dimension

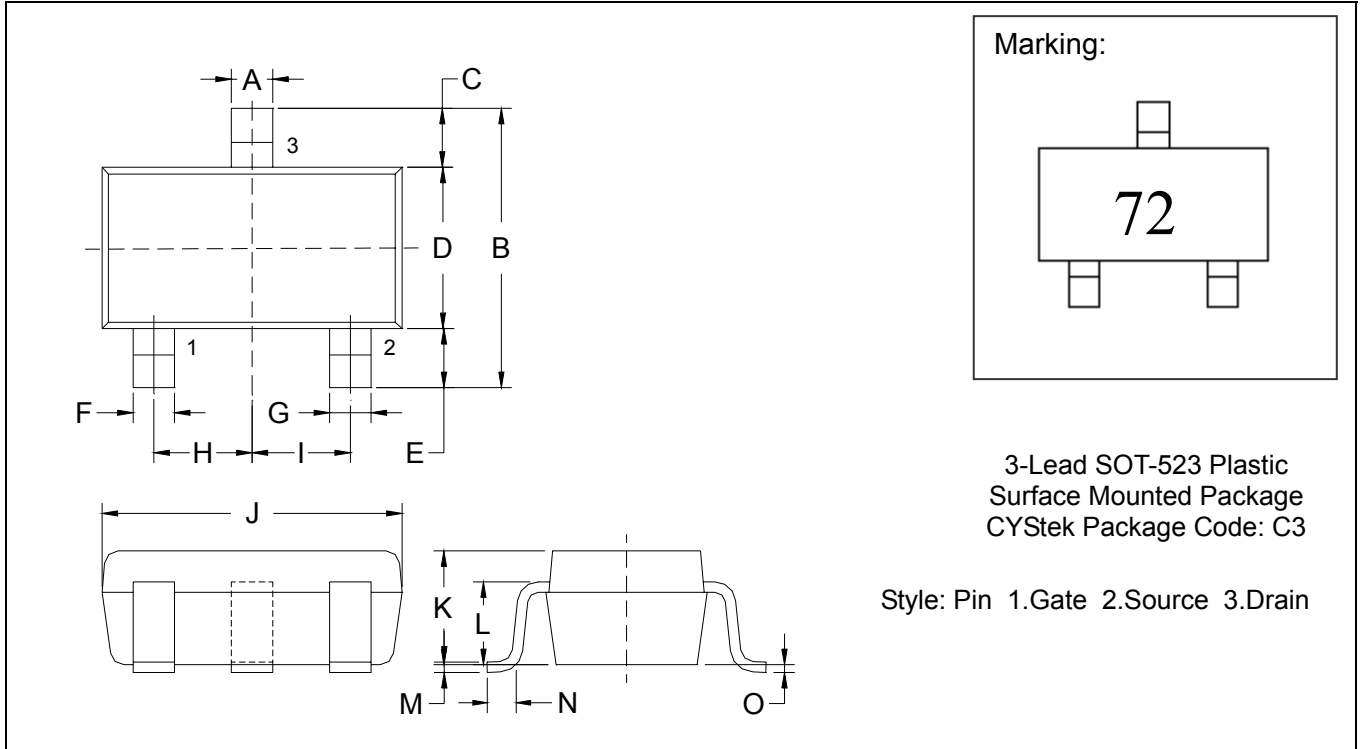

*: Typical

DIM	Inches		Millimeters		DIM	Inches		Millimeters	
	Min.	Max.	Min.	Max.		Min.	Max.	Min.	Max.
A	0.0079	0.0157	0.20	0.40	I	*0.0197	-	*0.50	-
B	0.0591	0.0669	1.50	1.70	J	0.0610	0.0650	1.55	1.65
C	0.0118	0.0197	0.30	0.50	K	0.0276	0.0315	0.70	0.80
D	0.0295	0.0335	0.75	0.85	L	0.0224	0.0248	0.57	0.63
E	0.0118	0.0197	0.30	0.50	M	0.0020	0.0059	0.05	0.15
F	0.0039	0.0118	0.10	0.30	N	0.0039	0.0118	0.10	0.30
G	0.0039	0.0118	0.10	0.30	O	0	0.0031	0	0.08
H	*0.0197	-	*0.50	-					

Notes: 1.Controlling dimension: millimeters.
 2.Maximum lead thickness includes lead finish thickness, and minimum lead thickness is the minimum thickness of base material.
 3.If there is any question with packing specification or packing method, please contact your local CYStek sales office.

Material:

- Lead: Pure tin plated.
- Mold Compound: Epoxy resin family, flammability solid burning class: UL94V-0.

Important Notice:

- All rights are reserved. Reproduction in whole or in part is prohibited without the prior written approval of CYStek.
- CYStek reserves the right to make changes to its products without notice.
- CYStek **semiconductor products are not warranted to be suitable for use in Life-Support Applications, or systems.**
- CYStek assumes no liability for any consequence of customer product design, infringement of patents, or application assistance.