

**FAIRCHILD**

A Schlumberger Company

**IRF420-423/IRF820-823 T-39-11**  
**MTP2N45/2N50**  
**N-Channel Power MOSFETs,**  
**3.0 A, 450 V/500 V**

Power And Discrete Division

**Description**

These devices are n-channel, enhancement mode, power MOSFETs designed especially for high speed applications, such as switching power supplies, converters, AC and DC motor controls, relay and solenoid drivers and other pulse circuits.

- Low  $R_{DS(on)}$
- $V_{GS}$  Rated at  $\pm 20$  V
- Silicon Gate for Fast Switching Speeds
- $I_{DSS}$ ,  $V_{DS(on)}$ , Specified at Elevated Temperature
- Rugged
- Low Drive Requirements
- Ease of Paralleling

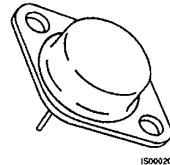
**TO-204AA**

IRF420  
IRF421  
IRF422  
IRF423

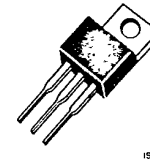
**TO-220AB**

IRF820  
IRF821  
IRF822  
IRF823  
MTP2N45  
MTP2N50

**Product Summary**

Part Number	$V_{DSS}$	$R_{DS(on)}$	$I_D$ at $T_C = 25^\circ C$	$I_D$ at $T_C = 100^\circ C$	Case Style
IRF420	500 V	3.0 $\Omega$	2.5 A	1.5 A	TO-204AA
IRF421	450 V	3.0 $\Omega$	2.5 A	1.5 A	
IRF422	500 V	4.0 $\Omega$	2.0 A	1.0 A	
IRF423	450 V	4.0 $\Omega$	2.0 A	1.0 A	
IRF820	500 V	3.0 $\Omega$	2.5 A	1.5 A	TO-220AB
IRF821	450 V	3.0 $\Omega$	2.5 A	1.5 A	
IRF822	500 V	4.0 $\Omega$	2.0 A	1.0 A	
IRF823	450 V	4.0 $\Omega$	2.0 A	1.0 A	
MTP2N45	450 V	4.0 $\Omega$	3.0 A	2.0 A	
MTP2N50	500 V	4.0 $\Omega$	3.0 A	2.0 A	

**Notes**

For information concerning connection diagram and package outline, refer to Section 7.

**IRF420-423/IRF820-823**  
**MTP2N45/2N50**

T-39-11

**Maximum Ratings**

Symbol	Characteristic	Rating IRF420/422 IRF820/822 MTP2N50	Rating IRF421/423 IRF821/823 MTP2N45	Unit
V <sub>DSS</sub>	Drain to Source Voltage <sup>1</sup>	500	450	V
V <sub>DGR</sub>	Drain to Gate Voltage <sup>1</sup> R <sub>GS</sub> = 20 kΩ	500	450	V
V <sub>GS</sub>	Gate to Source Voltage	± 20	± 20	V
T <sub>J</sub> , T <sub>stg</sub>	Operating Junction and Storage Temperatures	-55 to +150	-55 to +150	°C
T <sub>L</sub>	Maximum Lead Temperature for Soldering Purposes, 1/8" From Case for 5 s	275	275	°C

**Maximum Thermal Characteristics**

		IRF420-423/ IRF820-823	MTP2N45/2N50	
R <sub>θJC</sub>	Thermal Resistance, Junction to Case	3.12	1.67	°C/W
R <sub>θJA</sub>	Thermal Resistance, Junction to Ambient	30/80	80	°C/W
P <sub>D</sub>	Total Power Dissipation at T <sub>C</sub> = 25°C	40	75	W
I <sub>DM</sub>	Pulsed Drain Current <sup>2</sup>	10	10	A

**Electrical Characteristics (T<sub>C</sub> = 25°C unless otherwise noted)**

Symbol	Characteristic	Min	Max	Unit	Test Conditions
<b>Off Characteristics</b>					
V <sub>(BR)DSS</sub>	Drain Source Breakdown Voltage <sup>1</sup>			V	V <sub>GS</sub> = 0 V, I <sub>D</sub> = 250 μA
	IRF420/422/820/822/ MTP2N50	500			
	IRF421/423/821/823/ MTP2N45	450			
I <sub>DSS</sub>	Zero Gate Voltage Drain Current		250	μA	V <sub>DS</sub> = Rated V <sub>DSS</sub> , V <sub>GS</sub> = 0 V
			1000	μA	V <sub>DS</sub> = 0.8 x Rated V <sub>DSS</sub> , V <sub>GS</sub> = 0 V, T <sub>C</sub> = 125°C
I <sub>GSS</sub>	Gate-Body Leakage Current			nA	V <sub>GS</sub> = ± 20 V, V <sub>DS</sub> = 0 V
	IRF420-423		± 100		
	IRF820-823/MTP2N45/50		± 500		

**IRF420-423/IRF820-823**  
**MTP2N45/2N50**

T-39-11

**Electrical Characteristics (Cont.)** ( $T_C = 25^\circ\text{C}$  unless otherwise noted)

Symbol	Characteristic	Min	Max	Unit	Test Conditions
<b>On Characteristics</b>					
$V_{GS(th)}$	Gate Threshold Voltage			V	$I_D = 250 \mu\text{A}$ , $V_{DS} = V_{GS}$ $I_D = 1.0 \text{ mA}$ , $V_{DS} = V_{GS}$
	IRF420-423/IRF820-823	2.0	4.0		
	MTP2N45/MTP2N50	2.0	4.5		
$R_{DS(on)}$	Static Drain-Source On-Resistance <sup>2</sup>			$\Omega$	$V_{GS} = 10 \text{ V}$ , $I_D = 1.0 \text{ A}$
	IRF420/421/820/821		3.0		
	IRF422/423/822/823		4.0		
	MTP2N45/50		4.0		
$V_{DS(on)}$	Drain-Source On-Voltage <sup>2</sup>			V	$V_{GS} = 10 \text{ V}$ ; $I_D = 2.0 \text{ A}$ $V_{GS} = 10 \text{ V}$ ; $I_D = 1.0 \text{ A}$ $T_C = 100^\circ\text{C}$
	MTP2N45/50		10		
			8		
$g_{fs}$	Forward Transconductance	1.0		S ( $\Omega$ )	$V_{DS} = 10 \text{ V}$ , $I_D = 1.0 \text{ A}$

**Dynamic Characteristics**

$C_{iss}$	Input Capacitance		400	pF	$V_{DS} = 25 \text{ V}$ , $V_{GS} = 0 \text{ V}$ $f = 1.0 \text{ MHz}$
$C_{oss}$	Output Capacitance		100	pF	
$C_{rss}$	Reverse Transfer Capacitance		40	pF	

**Switching Characteristics** ( $T_C = 25^\circ\text{C}$ , Figures 1, 2)<sup>3</sup>

$t_{d(on)}$	Turn-On Delay Time		40	ns	$V_{DD} = 250 \text{ V}$ , $I_D = 1.0 \text{ A}$ $V_{GS} = 10 \text{ V}$ , $R_{GEN} = 50 \Omega$ $R_{GS} = 50 \Omega$
$t_r$	Rise Time		50	ns	
$t_{d(off)}$	Turn-Off Delay Time		60	ns	
$t_f$	Fall Time		60	ns	
$Q_g$	Total Gate Charge		15	nC	$V_{GS} = 10 \text{ V}$ , $I_D = 3.0 \text{ A}$ $V_{DD} = 200 \text{ V}$

Symbol	Characteristic	Typ	Max	Unit	Test Conditions
<b>Source-Drain Diode Characteristics</b>					
$V_{SD}$	Diode Forward Voltage		1.4	V	$I_S = 2.5 \text{ A}$ ; $V_{GS} = 0 \text{ V}$
			1.3	V	$I_S = 2.0 \text{ A}$ ; $V_{GS} = 0 \text{ V}$
$t_{rr}$	Reverse Recovery Time	600		ns	$I_S = 2.5 \text{ A}$ ; $dI_S/dt = 100 \text{ A}/\mu\text{S}$

**Notes**

- $T_J = +25^\circ\text{C}$  to  $+150^\circ\text{C}$
- Pulse width limited by  $T_J$
- Switching time measurements performed on LEM TR-58 test equipment.

IRF420-423/IRF820-823

MTP2N45/2N50

T-39-11

Typical Electrical Characteristics

Figure 1 Switching Test Circuit

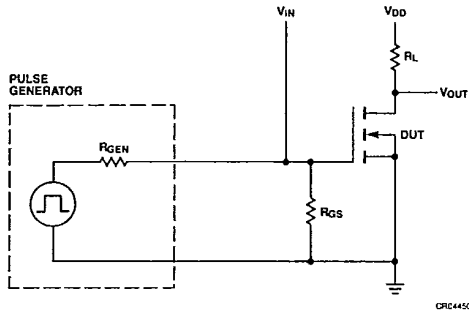

CRC4450F

Figure 2 Switching Waveforms

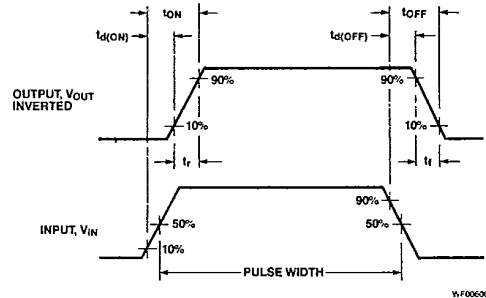

WF00000F

Typical Performance Curves

Figure 3 Output Characteristics

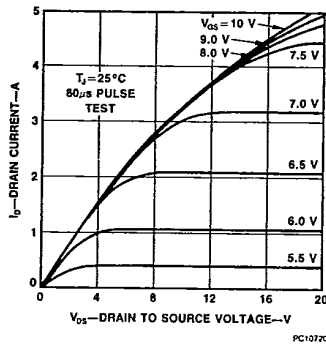

PC10720F

Figure 4 Static Drain to Source Resistance vs Drain Current

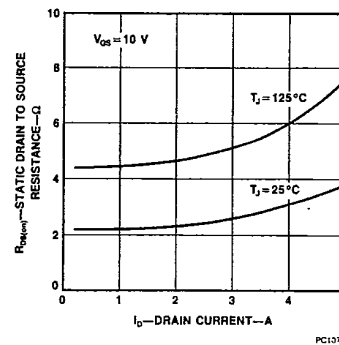

PC13730F

Figure 5 Transfer Characteristics

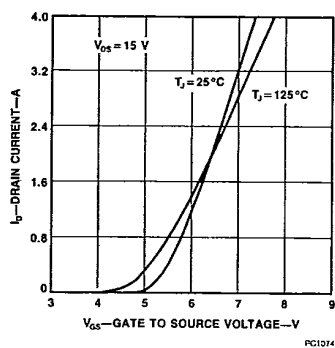

PC10740F

Figure 6 Temperature Variation of Gate to Source Threshold Voltage

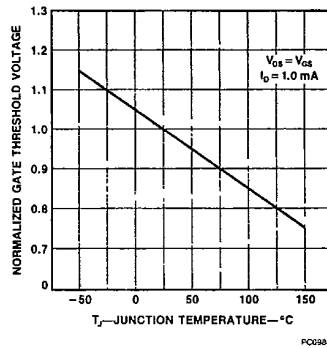

PC03841F

IRF420-423/IRF820-823  
MTP2N45/2N50

T-39-11

Typical Performance Curves (Cont.)

Figure 7 Capacitance vs Drain to Source Voltage

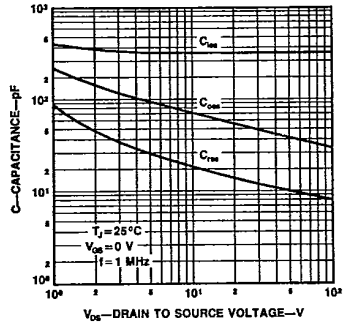

Figure 9 Forward Biased Safe Operating Area for IRF420-423 and IRF820-823

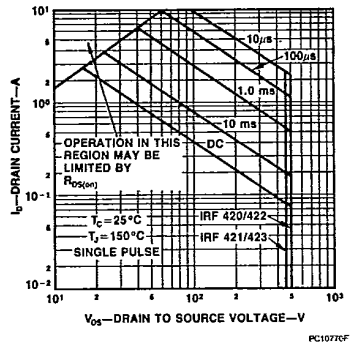

Figure 11 Forward Biased Safe Operating Area for MTP2N45/2N50

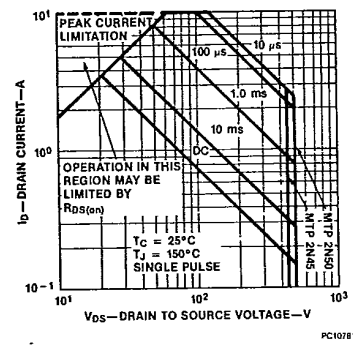

Figure 8 Gate to Source Voltage vs Total Gate Charge

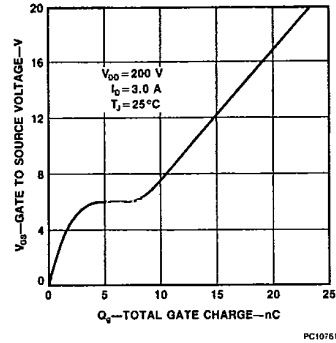

Figure 10 Transient Thermal Resistance vs Time for IRF420-423 and IRF820-823

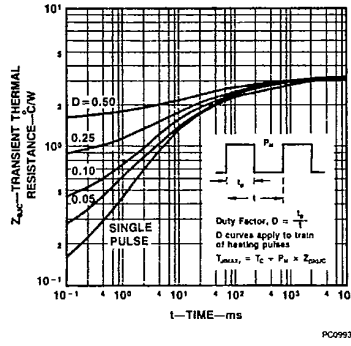

Figure 12 Transient Thermal Resistance vs Time for MTP2N45/2N50

