

## Three-Phase Bridge Rectifier, 300A MTP30008 Thru MTP30018

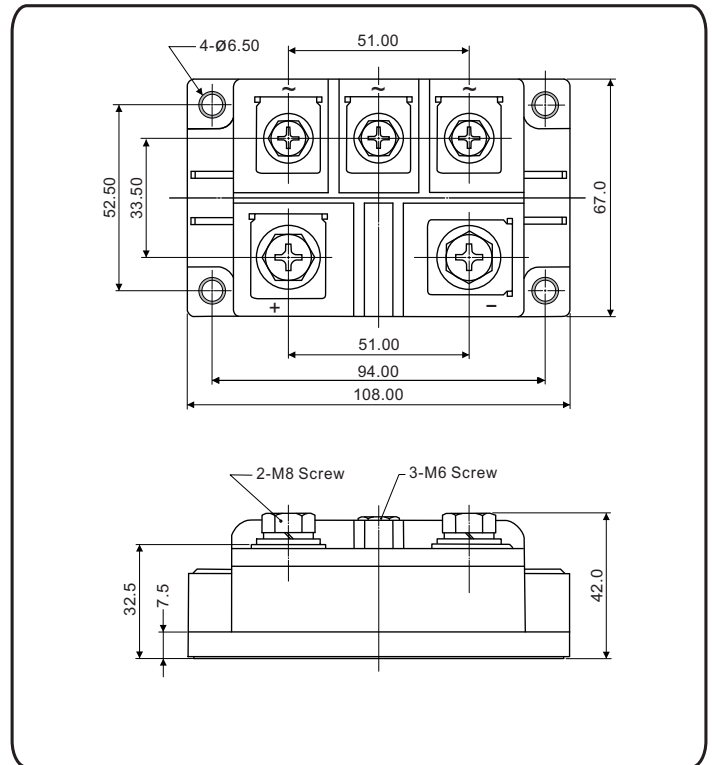

### FEATURES

- UL recognition file number E320098
- Typical IR less than 5.0  $\mu$ A
- High surge current capability
- Low thermal resistance
- Compliant to RoHS
- Isolation voltage up to 2500V

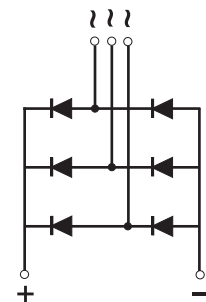

### TYPICAL APPLICATIONS

- DC power supplies for apparatus device
- Input rectifying power supplies for PWM converters
- Field supplies for DC motors
- Inverter welders

### ADVANTAGE

- International standard package  
Epoxy meets UL 94 V-O flammability rating
- Small volume, light weight
- Weight: 600g (21.2 ozs)

### PRIMARY CHARACTERISTICS

$I_{F(AV)}$	300A
$V_{RRM}$	800V to 1800V
$I_{FSM}$	4000A
$I_R$	20 $\mu$ A
$V_F$	1.30V
$T_{J \max.}$	150°C

MAJOR RATINGS AND CHARACTERISTICS ( $T_A = 25^\circ\text{C}$ unless otherwise noted)							
PARAMETER	SYMBOL	MTP300					UNIT
		08	10	12	16	18	
Maximum repetitive peak reverse voltage	$V_{RRM}$	800	1000	1200	1600	1800	V
Peak reverse non-repetitive voltage	$V_{RSM}$	900	1100	1300	1700	1900	V
Maximum DC blocking voltage	$V_{DC}$	800	1000	1200	1600	1800	V
Maximum average forward rectified output current at $T_C = 100^\circ\text{C}$	$I_{F(AV)}$	300					A
Peak forward surge current single sine-wave superimposed on rated load	$I_{FSM}$	4000					A
Rating (non-repetitive, for t greater than 1 ms and less than 8.3 ms) for fusing	$I^2t$	66.4					$\text{KA}^2\text{s}$
RMS isolation voltage from case to leads	$V_{ISO}$	2500					V
Operating junction storage temperature range	$T_J$	-40 to 150					$^\circ\text{C}$
Storage temperature range	$T_{STG}$	-40 to 125					$^\circ\text{C}$

ELECTRICAL CHARACTERISTICS ( $T_A = 25^\circ\text{C}$ unless otherwise noted)								
PARAMETER	TEST CONDITIONS	SYMBOL	MTP300					UNIT
			08	10	12	16	18	
Maximum instantaneous forward drop per diode	$I_F = 300\text{A}$	$V_F$	1.30					V
Maximum reverse DC current at rated DC blocking voltage per diod	$T_A = 25^\circ\text{C}$	$I_R$	20					$\mu\text{A}$
	$T_A = 150^\circ\text{C}$		10					mA

THERMAL AND MECHANICAC ( $T_A = 25^\circ\text{C}$ unless otherwise noted)								
PARAMETER	TEST CONDITIONS	SYMBOL	MTP300					UNIT
			08	10	12	16	18	
Typical thermal resistance junction to case	Single-side heat dissipation, sine half wave	$R_{\theta JC}^{(1)}$	0.08					$^\circ\text{C/W}$
Mounting torque $\pm 10\%$ to heatsink M6 to terminal M8	A mounting compound is recommended and the torque should be rechecked after a period of 3 hours to allow for the spread of the compound.		4					Nm
			10					
Approximate weight			600					g

Notes

(1) With heatsink, single side heat dissipation, half sine wave.

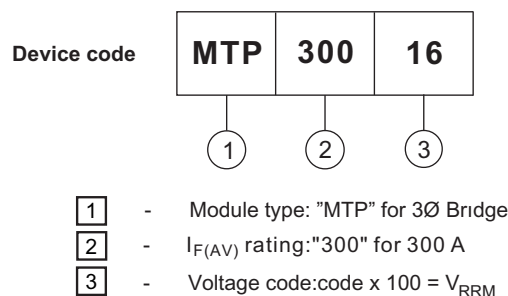

**Fig.1 Forward current vs. Forward voltage**

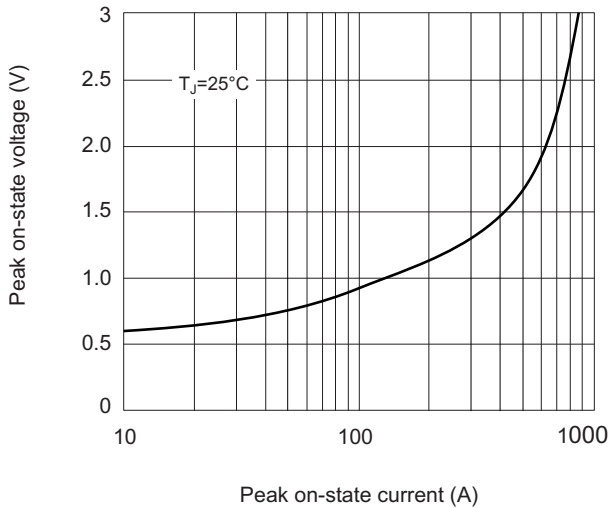

**Fig.2 Thermal Impedance (junction to case)**

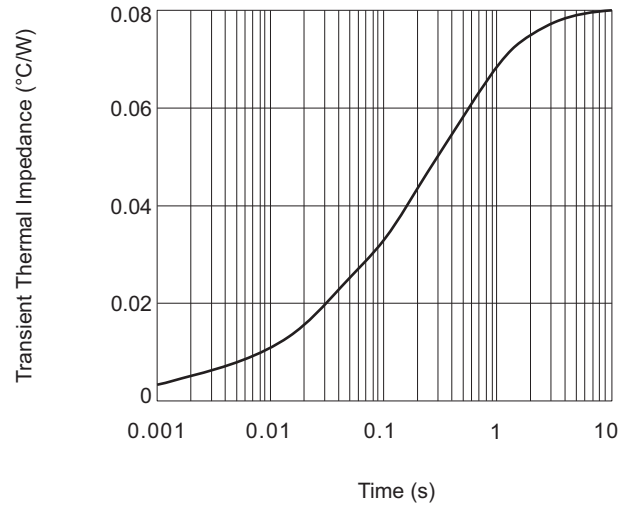

**Fig.3 Power Consumption vs. Average Current**

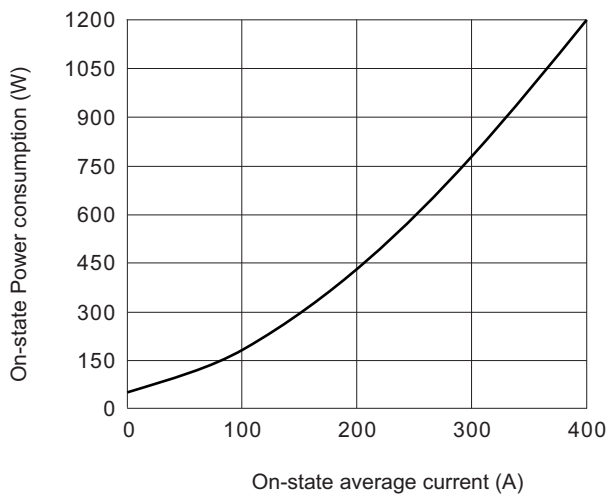

**Fig.4 Case Temperature vs. O-state Average Current**

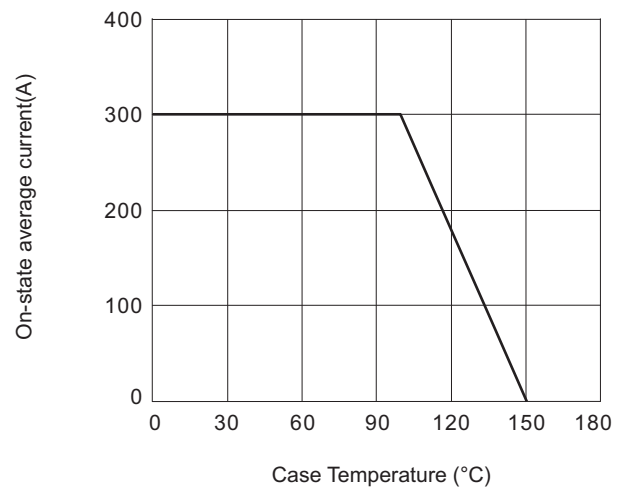

**Fig.5 Forward Surge Current vs. Cycle**

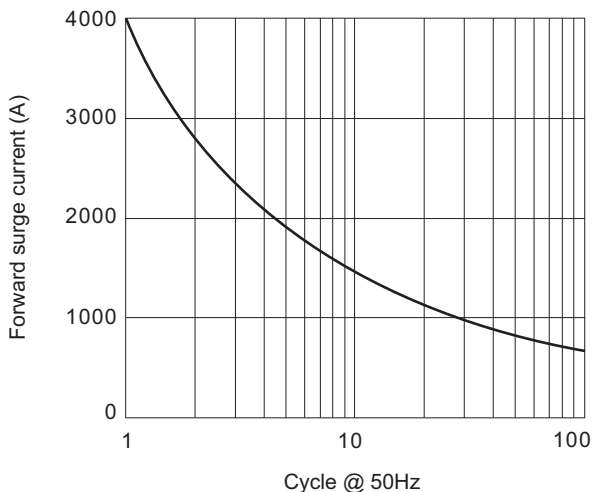

**Fig.6 I<sup>2</sup>t characteristic**

