

**30V P-CHANNEL Enhancement Mode MOSFET**

# MTP3LP01S3

BV <sub>DSS</sub>	-30V
I <sub>D</sub>	-230mA
R <sub>DS(on)(typ)</sub>	3 Ω @-4V
	4.6 Ω @-2.5V
	10.9 Ω @-1.5V

**Features**

- Ultra high speed switching.
- Low gate charge.
- 2.5V drive.
- Pb-free package.

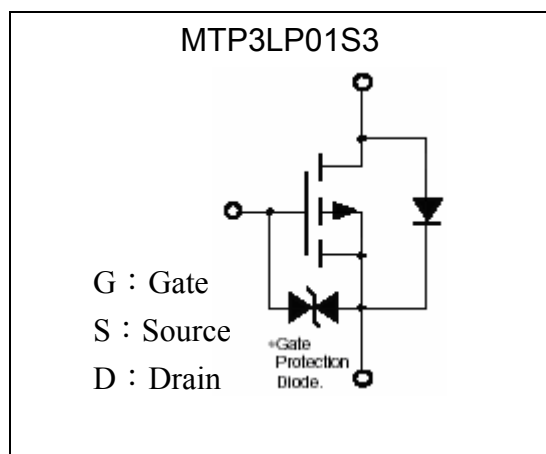
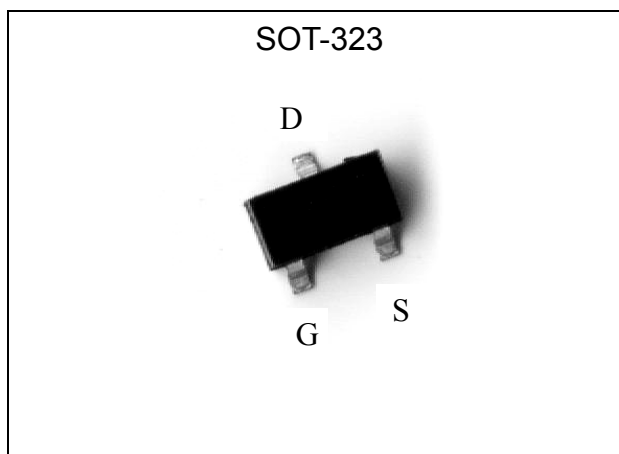
**Equivalent Circuit**

**Outline**

**Ordering Information**

Device	Package	Shipping
MTP3LP01S3-0-T1-G	SOT-323 (Pb-free lead plating and halogen-free package)	3000 pcs / Tape & Reel



**Absolute Maximum Ratings** (Ta=25°C, unless otherwise noted)

Parameter	Symbol	Limits	Unit
Drain-Source Voltage	V <sub>DS</sub>	-30	V
Gate-Source Voltage	V <sub>GS</sub>	±10	V
Continuous Drain Current	I <sub>D</sub>	-230	mA
Pulsed Drain Current (Note 1)	I <sub>DM</sub>	-920	mA
Maximum Power Dissipation (Note 2)	P <sub>D</sub>	200	mW
Thermal Resistance, Junction-to-Ambient	R <sub>th,ja</sub>	625	°C/W
Operating Junction and Storage Temperature	T <sub>j</sub> , T <sub>stg</sub>	-55~+150	°C

Note : 1. Pulse width ≤ 10μs, duty cycle ≤ 1%.  
 2. When mounted on a glass epoxy with a dimension of 100mm<sup>2</sup>×1mm.

**Electrical Characteristics** (Ta=25°C, unless otherwise specified)

Symbol	Min.	Typ.	Max.	Unit	Test Conditions
<b>Static</b>					
BV <sub>DSS</sub>	-30	-	-	V	V <sub>GS</sub> =0V, I <sub>D</sub> =-250μA
V <sub>GS(th)</sub>	-0.6	0.9	-1.1	V	V <sub>DS</sub> =-10V, I <sub>D</sub> =-100μA
G <sub>FS</sub>	100	210	-	mS	V <sub>DS</sub> =-10V, I <sub>D</sub> =-100mA
I <sub>GSS</sub>	-	-	±1	μA	V <sub>GS</sub> =±8V, V <sub>DS</sub> =0
I <sub>DSS</sub>	-	-	-1	μA	V <sub>DS</sub> =-30V, V <sub>GS</sub> =0
	-	-	-10		V <sub>DS</sub> =-24V, V <sub>GS</sub> =0; T <sub>j</sub> =125°C
*R <sub>DS(ON)</sub>	-	3	5	Ω	V <sub>GS</sub> =-4V, I <sub>D</sub> =-100mA
	-	4.6	8		V <sub>GS</sub> =-2.5V, I <sub>D</sub> =-30mA
	-	10.9	18		V <sub>GS</sub> =-1.5V, I <sub>D</sub> =-1mA
<b>Dynamic</b>					
C <sub>iss</sub>	-	35.7	-	pF	V <sub>DS</sub> =-20V, V <sub>GS</sub> =0, f=1MHz
C <sub>oss</sub>	-	11.9	-		
C <sub>rss</sub>	-	3.7	-		
*t <sub>d(ON)</sub>	-	26.4	-	ns	V <sub>DS</sub> =-15V, I <sub>D</sub> =-100mA, V <sub>GS</sub> =-4V, R <sub>L</sub> =150Ω, R <sub>G</sub> =50Ω
*t <sub>r</sub>	-	12.8	-		
*t <sub>d(OFF)</sub>	-	31.5	-		
*t <sub>f</sub>	-	46.4	-		
*Q <sub>g</sub>	-	0.78	-	nC	V <sub>DS</sub> =-10V, I <sub>D</sub> =-100mA, V <sub>GS</sub> =-10V
*Q <sub>gs</sub>	-	0.1	-		
*Q <sub>gd</sub>	-	0.1	-		
<b>Source-Drain Diode</b>					
*I <sub>S</sub>	-	-	-230	mA	
*I <sub>SM</sub>	-	-	-920		
*V <sub>SD</sub>	-	0.83	-1.2	V	V <sub>GS</sub> =0V, I <sub>S</sub> =-100mA

\*Pulse Test : Pulse Width ≤ 300μs, Duty Cycle ≤ 2%

**Typical Characteristics**(The minus sign in voltage and current is omitted)

Typical Output Characteristics

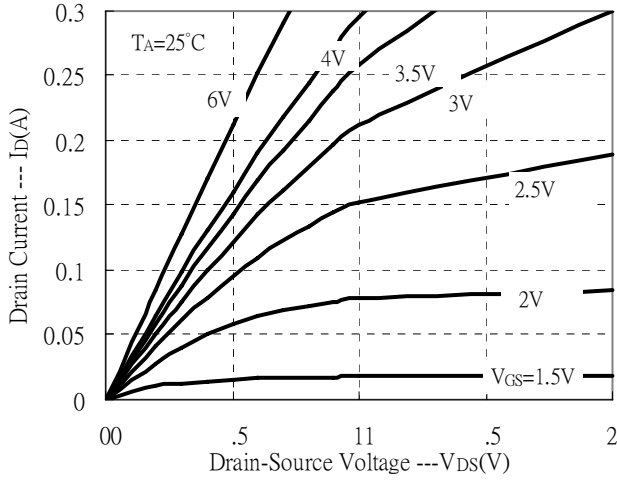

Typical Transfer Characteristics

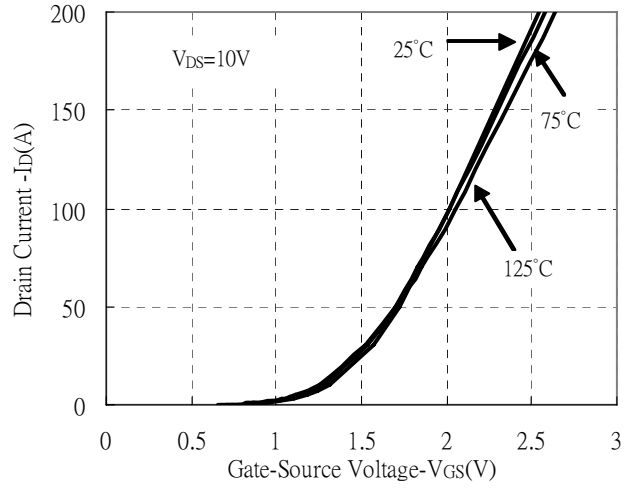

Static Drain-Source On-State Resistance vs Gate-Source Voltage

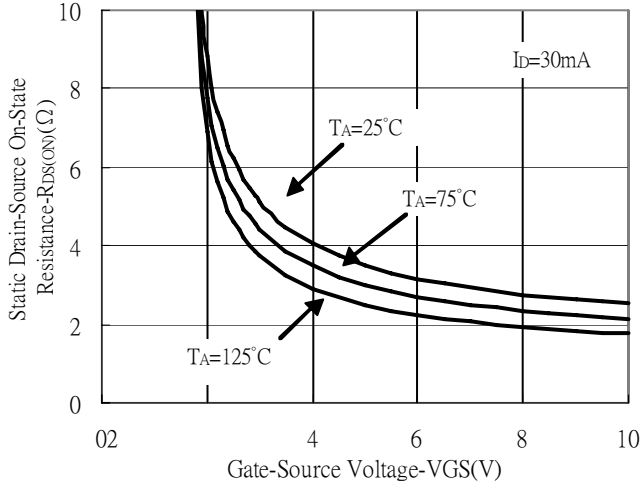

Static Drain-Source On-State Resistance vs Gate-Source Voltage

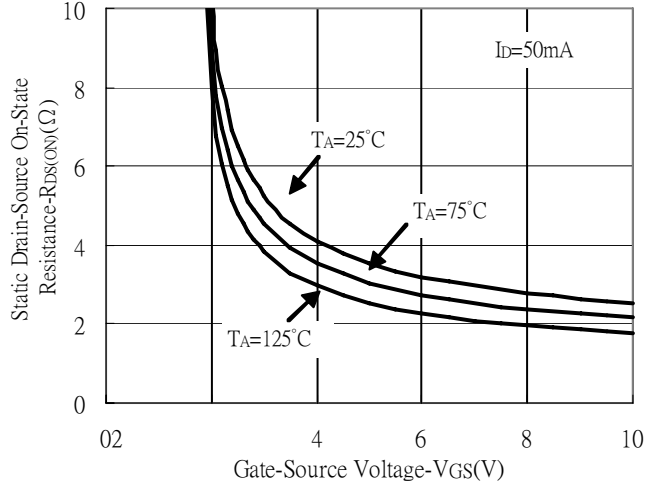

Static Drain-Source On-State resistance vs Drain Current

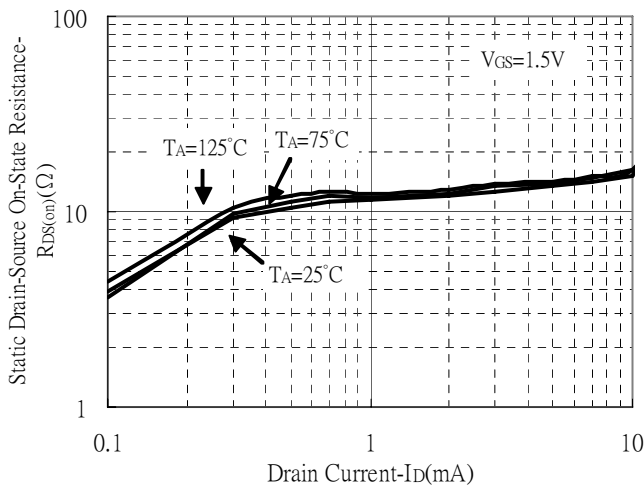

Static Drain-Source On-State resistance vs Drain Current

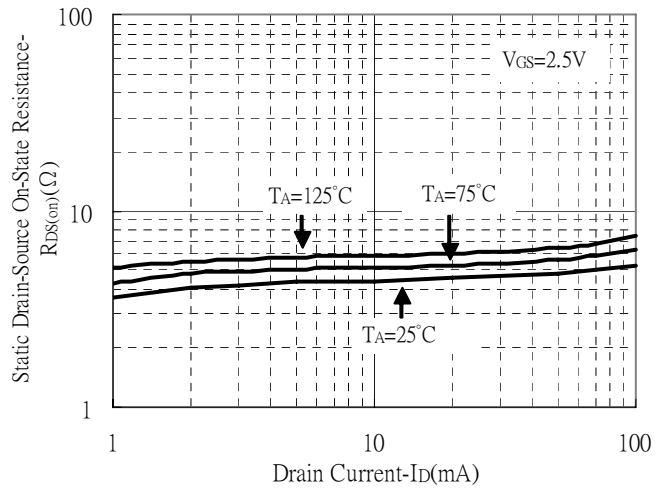

**Typical Characteristics(Cont.)**

Static Drain-Source On-State resistance vs Drain Current

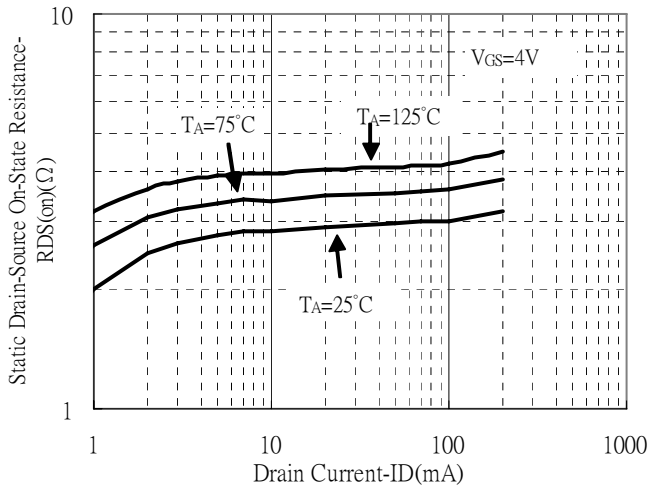

Static Drain-Source On-State resistance vs Ambient Temperature

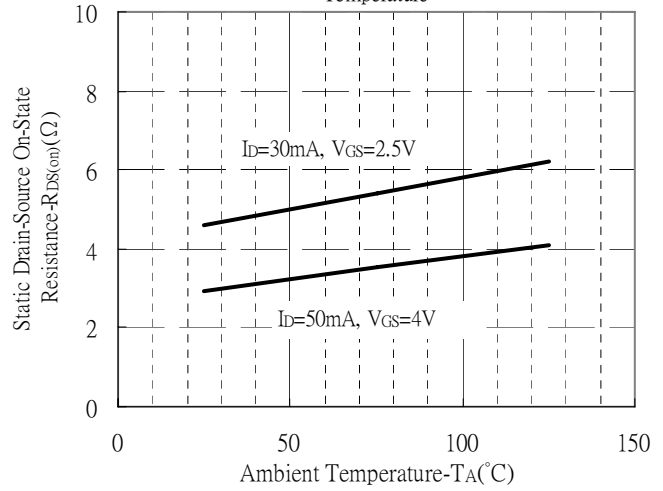

Reverse Drain Current vs Source-Drain Voltage

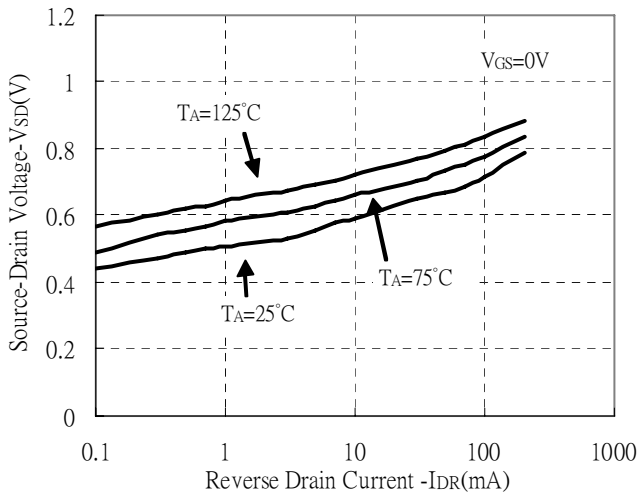

Capacitance vs Drain-to-Source Voltage

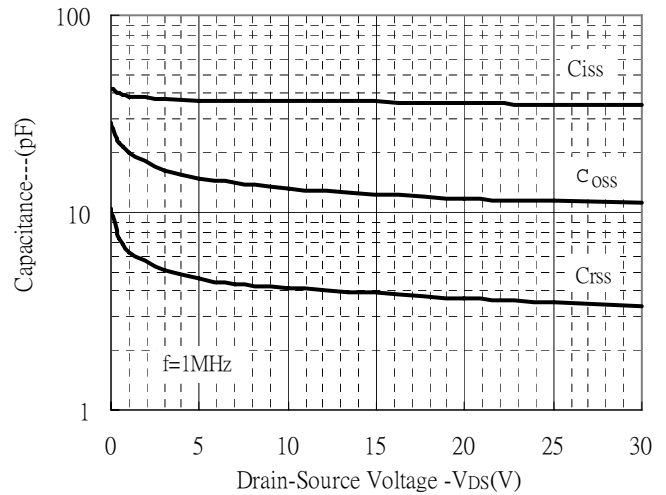

Forward Transfer Admittance vs Drain Current

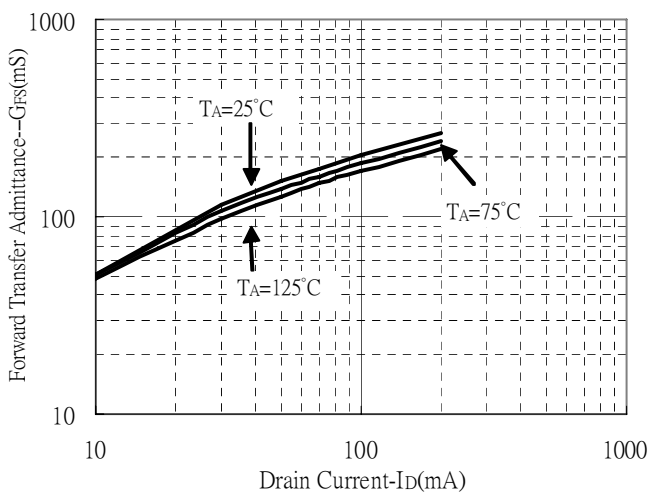

Brekdown Voltage vs Ambient Temperature

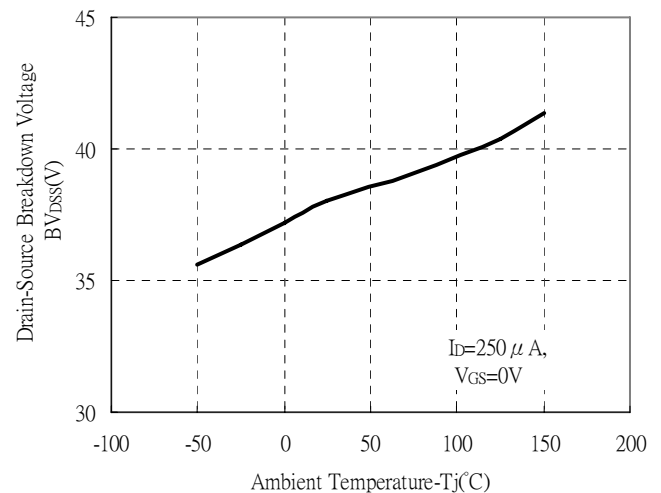

**Typical Characteristics(Cont.)**

Static Drain-Source On-resistance vs Ambient Temperature

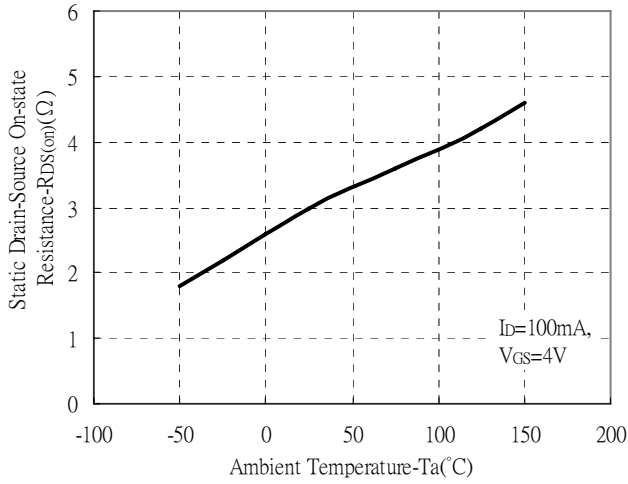

Gate Charge Characteristics

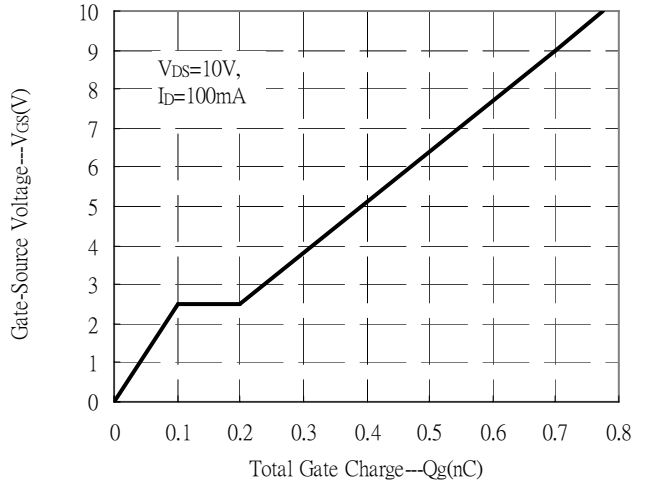

Power Derating Curves

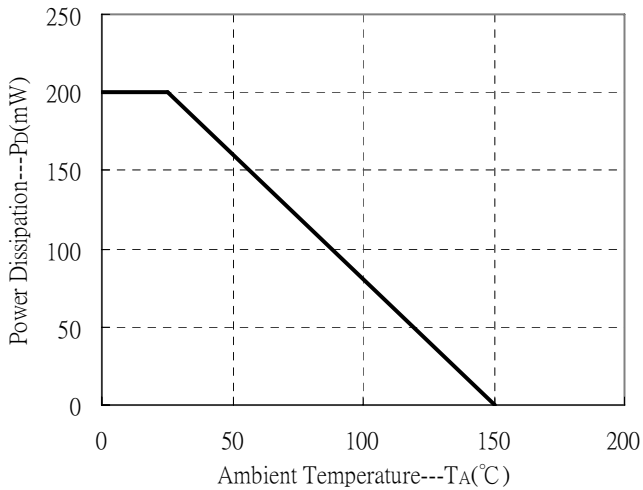

Maximum Safe Operating Area

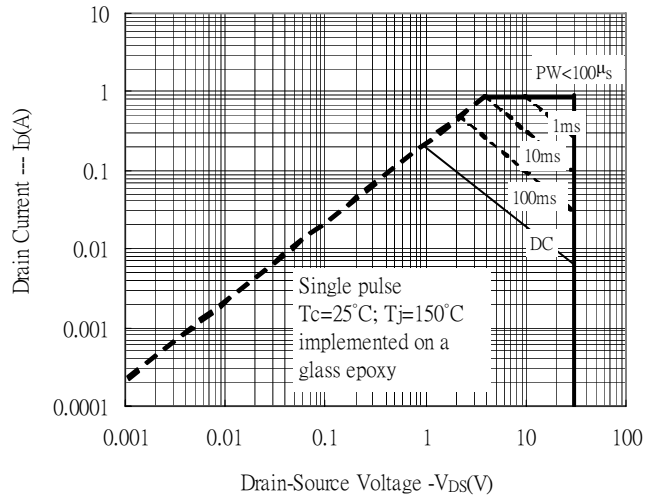



### Typical Characteristics(Cont.)

Transient Thermal Response Curves

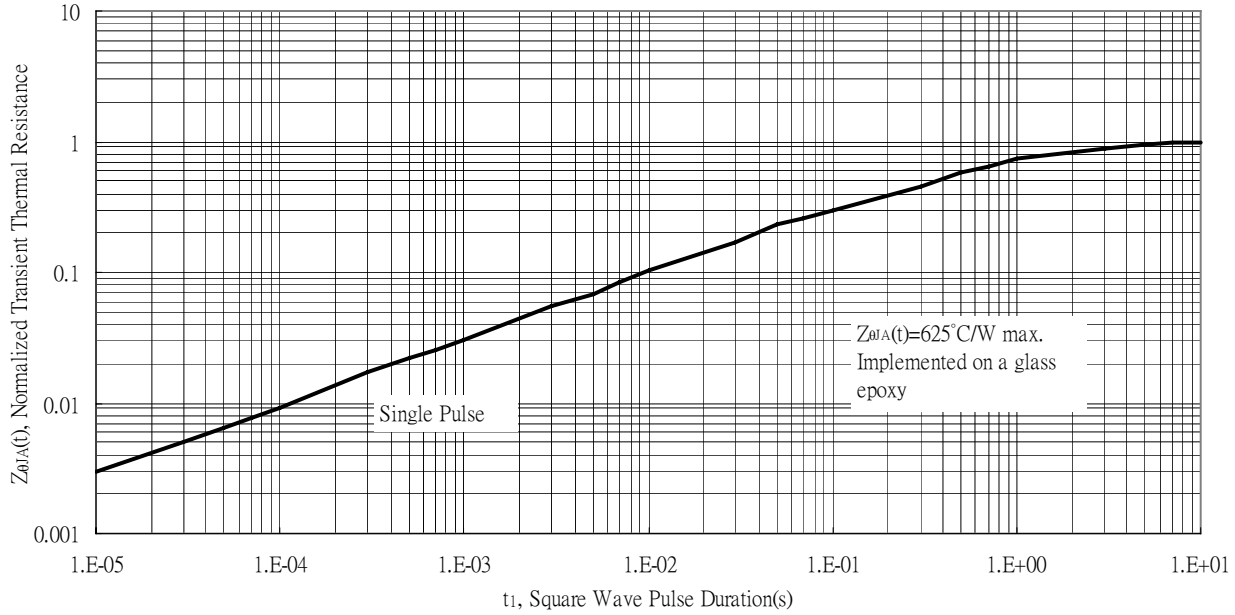

### Reel Dimension

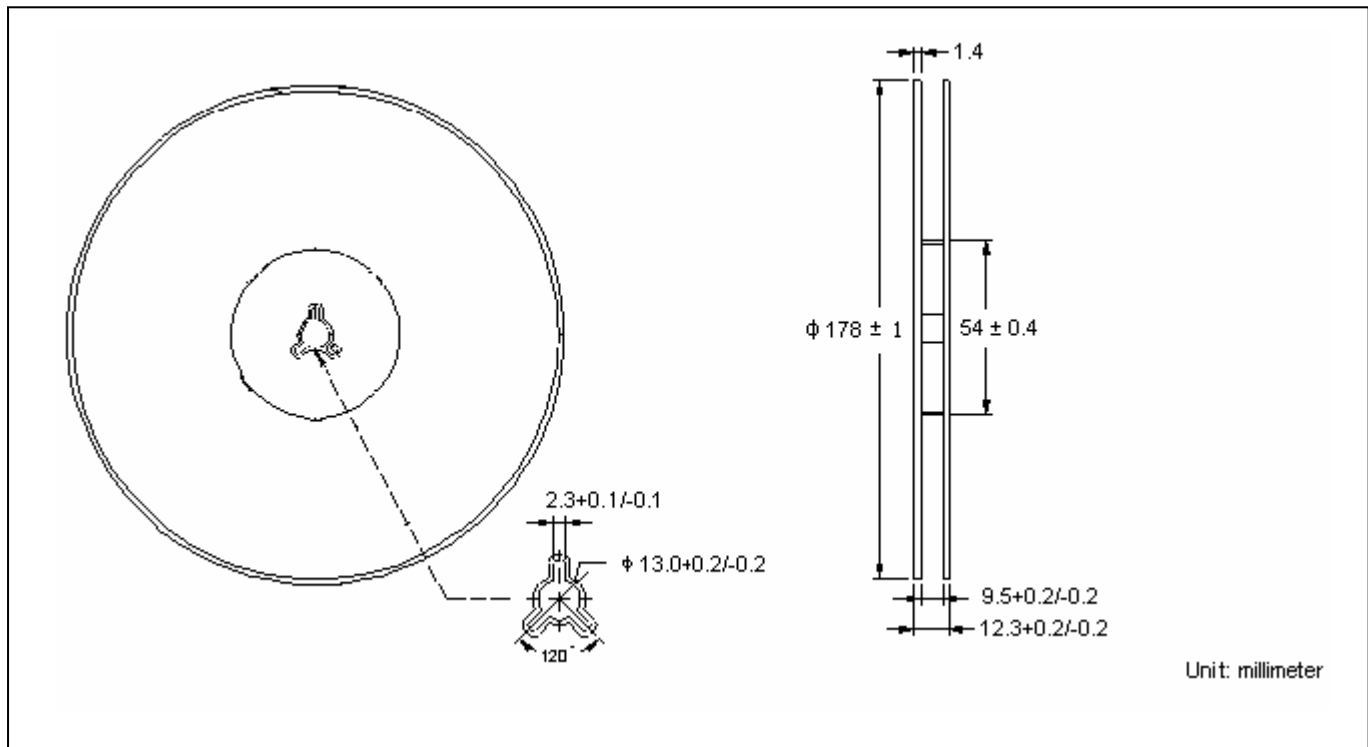

### Carrier Tape Dimension

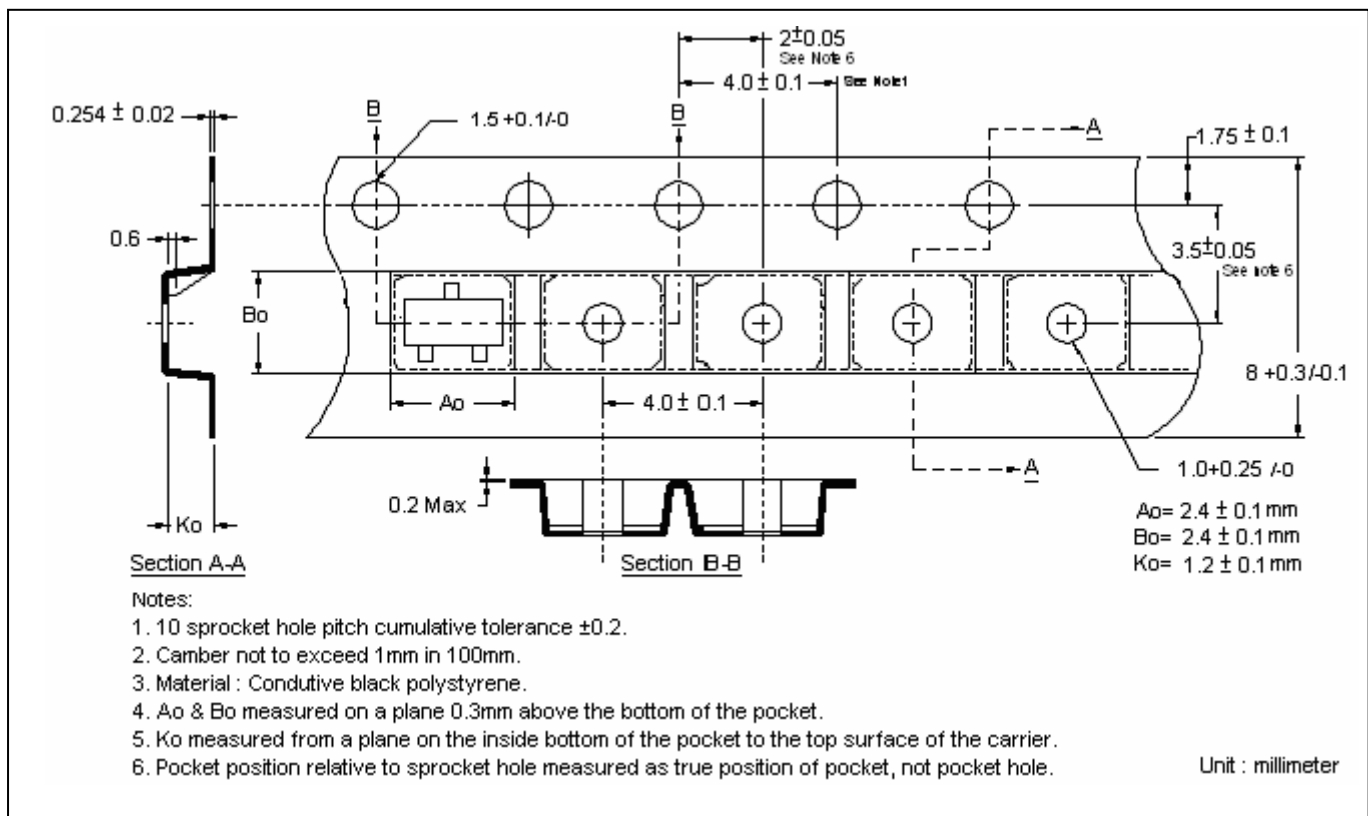

**Recommended temperature profile for IR reflow**

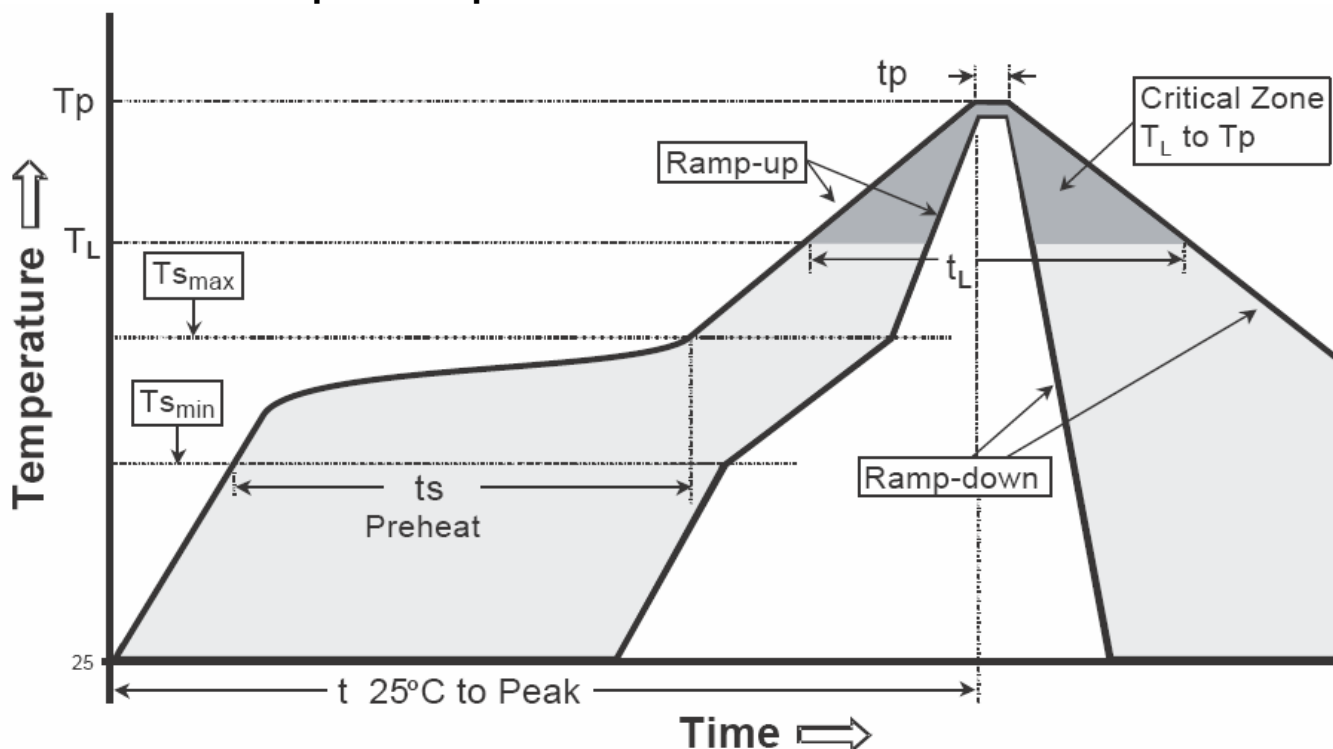

Profile feature	Sn-Pb eutectic Assembly	Pb-free Assembly
Average ramp-up rate (T <sub>smax</sub> to T <sub>p</sub> )	3°C/second max.	3°C/second max.
Preheat		
-Temperature Min(T <sub>s min</sub> )	100°C	150°C
-Temperature Max(T <sub>s max</sub> )	150°C	200°C
-Time(t <sub>s min</sub> to t <sub>s max</sub> )	60-120 seconds	60-180 seconds
Time maintained above:		
-Temperature (T <sub>L</sub> )	183°C	217°C
- Time (t <sub>L</sub> )	60-150 seconds	60-150 seconds
Peak Temperature(T <sub>P</sub> )	240 +0/-5 °C	260 +0/-5 °C
Time within 5°C of actual peak temperature(tp)	10-30 seconds	20-40 seconds
Ramp down rate	6°C/second max.	6°C/second max.
Time 25 °C to peak temperature	6 minutes max.	8 minutes max.

Note : All temperatures refer to topside of the package, measured on the package body surface.

**Recommended wave soldering condition**

Product	Peak Temperature	Soldering Time
Pb-free devices	260 +0/-5 °C	5 +1/-1 seconds



**SOT-323 Dimension**

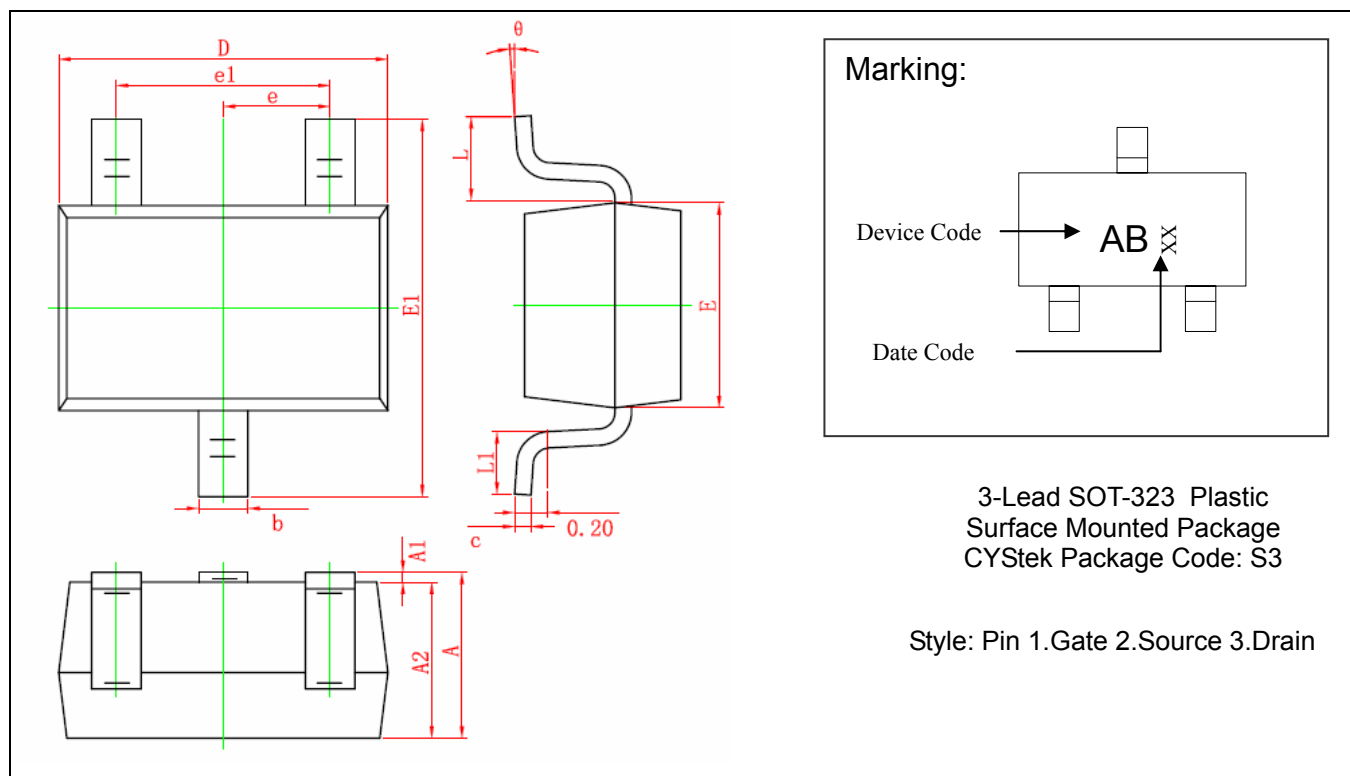

DIM	Millimeters		Inches		DIM	Millimeters		Inches	
	Min.	Max.	Min.	Max.		Min.	Max.	Min.	Max.
A	0.900	1.100	0.035	0.043	E1	2.150	2.450	0.085	0.096
A1	0.000	0.100	0.000	0.004	e	0.650	TYP	0.026	TYP
A2	0.900	1.000	0.035	0.039	e1	1.200	1.400	0.047	0.055
b	0.200	0.400	0.008	0.016	L	0.525	REF	0.021	REF
c	0.080	0.150	0.003	0.006	L1	0.260	0.460	0.010	0.018
D	2.000	2.200	0.079	0.087	θ	0°	8°	0°	8°
E	1.150	1.350	0.045	0.053					

Notes: 1.Controlling dimension: millimeters.  
 2.Maximum lead thickness includes lead finish thickness, and minimum lead thickness is the minimum thickness of base material.  
 3.If there is any question with packing specification or packing method, please contact your local CYStek sales office.

**Material:**

- Lead: Pure tin plated.
- Mold Compound: Epoxy resin family, flammability solid burning class: UL94V-0.

**Important Notice:**

- All rights are reserved. Reproduction in whole or in part is prohibited without the prior written approval of CYStek.
- CYStek reserves the right to make changes to its products without notice.
- CYStek **semiconductor products are not warranted to be suitable for use in Life-Support Applications, or systems.**
- CYStek assumes no liability for any consequence of customer product design, infringement of patents, or application assistance.