

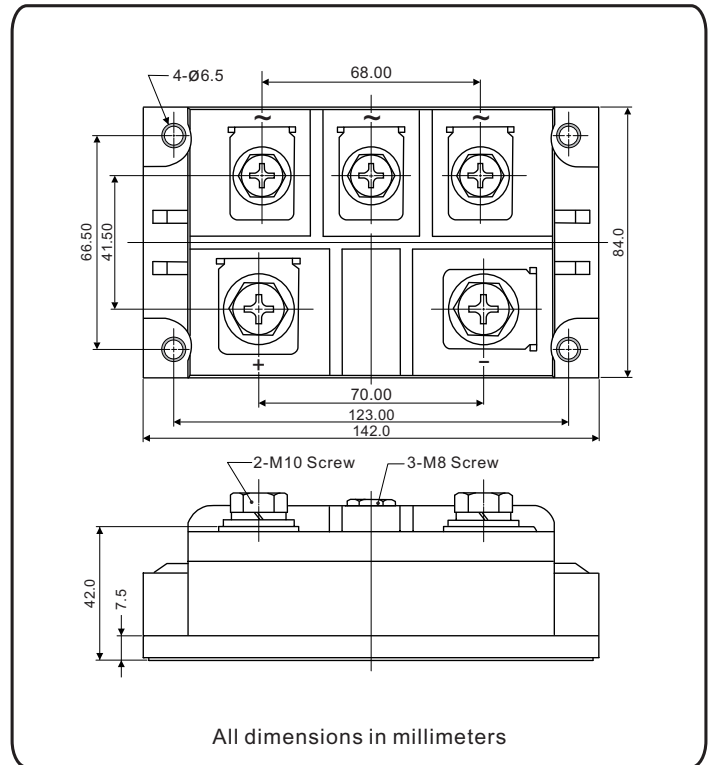

Three-Phase Bridge Rectifier, 400A MTP40008 Thru MTP40018



FEATURES

- UL recognition file number E320098 
- Typical IR less than 5.0 μ A
- High surge current capability
- Low thermal resistance
- Compliant to RoHS 
- Isolation voltage up to 2500V

TYPICAL APPLICATIONS

- DC power supplies for apparatus device
- Input rectifying power supplies for PWM converters
- Field supplies for DC motors
- Inverter welders

ADVANTAGE

- International standard package
Epoxy meets UL 94 V-O flammability rating
- Small volume, light weight
- Weight: 1100g (38.8 ozs)

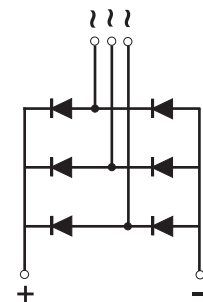

PRIMARY CHARACTERISTICS

$I_{F(AV)}$	400A
V_{RRM}	800V to 1800V
I_{FSM}	6000A
I_R	20 μ A
V_F	1.30V
$T_{J \max.}$	150°C

MAJOR RATINGS AND CHARACTERISTICS ($T_A = 25^\circ\text{C}$ unless otherwise noted)							
PARAMETER	SYMBOL	MTP400					UNIT
		08	10	12	16	18	
Maximum repetitive peak reverse voltage	V_{RRM}	800	1000	1200	1600	1800	V
Peak reverse non-repetitive voltage	V_{RSM}	900	1100	1300	1700	1900	V
Maximum DC blocking voltage	V_{DC}	800	1000	1200	1600	1800	V
Maximum average forward rectified output current at $T_C = 100^\circ\text{C}$	$I_{F(AV)}$	400					A
Peak forward surge current single sine-wave superimposed on rated load	I_{FSM}	6000					A
Rating (non-repetitive, for t greater than 1 ms and less than 8.3 ms) for fusing	I^2t	149.4					KA^2s
RMS isolation voltage from case to leads	V_{ISO}	2500					V
Operating junction storage temperature range	T_J	-40 to 150					$^\circ\text{C}$
Storage temperature range	T_{STG}	-40 to 125					$^\circ\text{C}$

ELECTRICAL CHARACTERISTICS ($T_A = 25^\circ\text{C}$ unless otherwise noted)								
PARAMETER	TEST CONDITIONS	SYMBOL	MTP400					UNIT
			08	10	12	16	18	
Maximum instantaneous forward drop per diode	$I_F = 400\text{A}$	V_F	1.30					V
Maximum reverse DC current at rated DC blocking voltage per diod	$T_A = 25^\circ\text{C}$	I_R	20					μA
	$T_A = 150^\circ\text{C}$		10					mA

THERMAL AND MECHANICAC ($T_A = 25^\circ\text{C}$ unless otherwise noted)								
PARAMETER	TEST CONDITIONS	SYMBOL	MTP400					UNIT
			08	10	12	16	18	
Typical thermal resistance junction to case	Single-side heat dissipation, sine half wave	$R_{\theta JC}^{(1)}$	0.065					$^\circ\text{C/W}$
Mounting torque $\pm 10\%$ to heatsink M6 to terminal M8 to terminal M10	A mounting compound is recommended and the torque should be rechecked after a period of 3 hours to allow for the spread of the compound.		4					Nm
			10					
			12					
Approximate weight			1100					g

Notes

(1) With heatsink, single side heat dissipation, half sine wave.

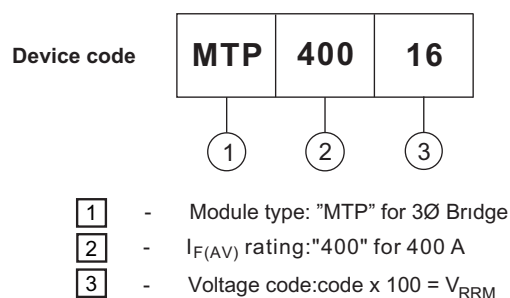

Fig.1 Forward current vs. Forward voltage

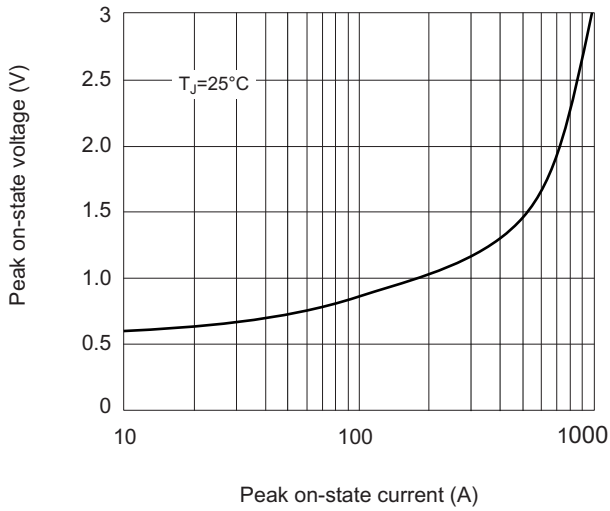

Fig.2 Thermal Impedance (junction to case)

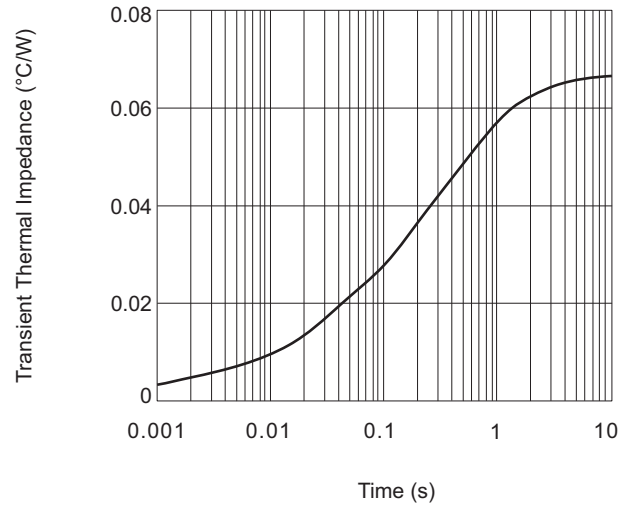

Fig.3 Power Consumption vs. Average Current

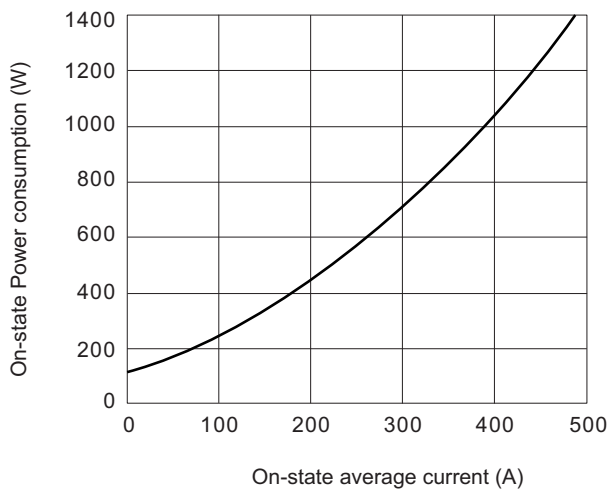

Fig.4 Case Temperature vs. O-state Average Current

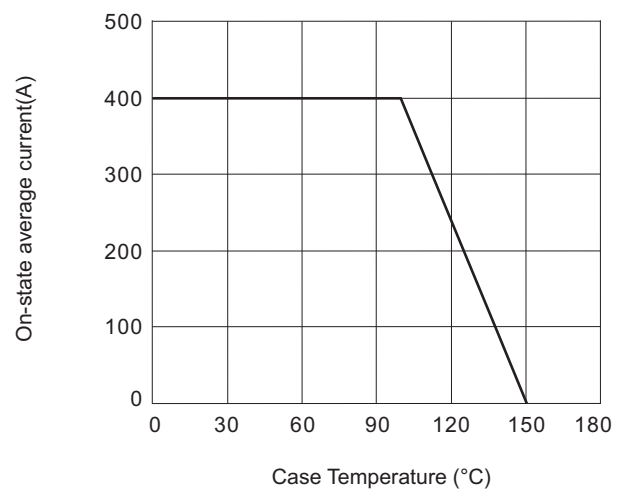

Fig.5 Forward Surge Current vs. Cycle

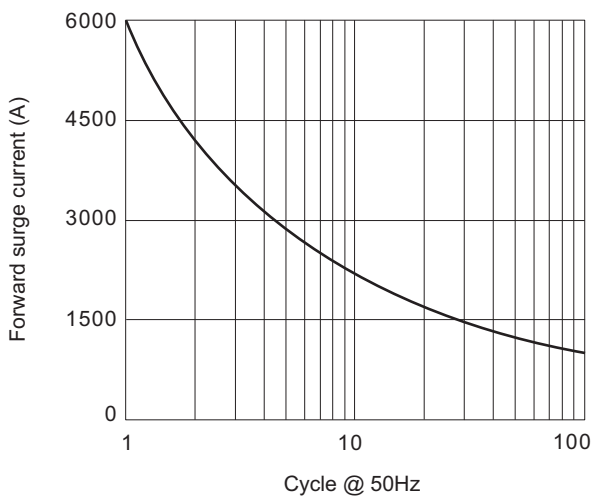

Fig.6 I²t characteristic

