

P-CHANNEL ENHANCEMENT MODE POWER MOSFET

MTP4409Q8

BVDSS	-30V
ID	-15A
RDSON@VGS=-10V, ID=-15A	7.7mΩ (typ)
RDSON@VGS=-4.5V, ID=-10A	11.4mΩ (typ)

Description

The MTP4409Q8 is a P-channel enhancement-mode MOSFET, providing the designer with the best combination of fast switching, ruggedized device design, low on-resistance and cost effectiveness. The SOP-8 package is universally preferred for all commercial-industrial surface mount applications and suited for low voltage applications such as DC/DC converters.

Features

- Simple drive requirement
- Low on-resistance
- Fast switching speed
- Pb-free and Halogen-free package

Equivalent Circuit

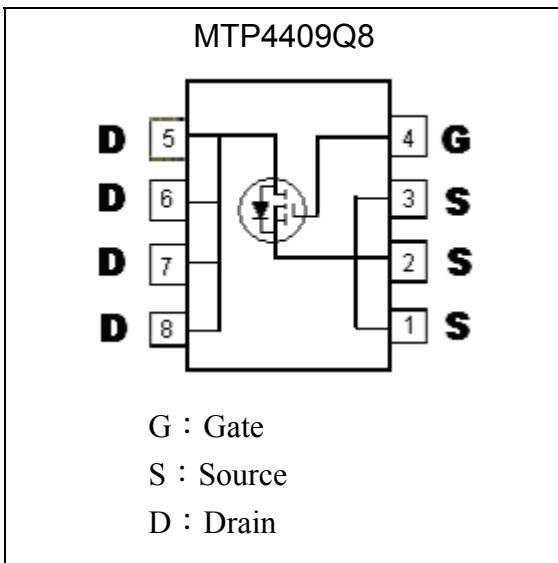

Outline

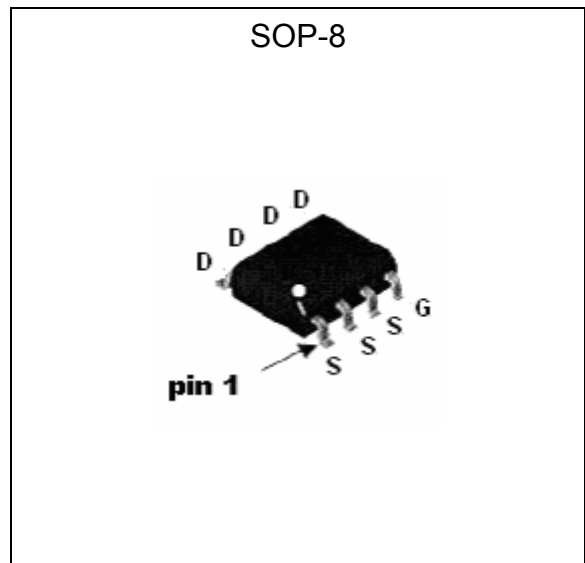



Absolute Maximum Ratings (T_C=25°C, unless otherwise noted)

Parameter	Symbol	Limits	Unit	
Drain-Source Breakdown Voltage	BV _{DSS}	-30	V	
Gate-Source Voltage	V _{GS}	±20	V	
Continuous Drain Current @T _A =25 °C	I _D	-15	A	
Continuous Drain Current @T _A =100 °C	I _D	-9.5	A	
Pulsed Drain Current (Note 1)	I _{DM}	-160	A	
Avalanche Current	I _{AS}	-15	A	
Avalanche Energy @ L=0.1mH, I _D =-15A, R _G =25 Ω	E _{AS}	11.25	mJ	
Power Dissipation (Note 2)	P _D	T _A =25 °C	3.1	W
		T _A =100 °C	1.2	W
Operating Junction and Storage Temperature Range	T _j ; T _{stg}	-55~+150	°C	

Note : 1.Pulse width limited by maximum junction temperature.
 2.Surface mounted on 1 in² copper pad of FR-4 board, t≤10s.

Electrical Characteristics (T_C=25°C, unless otherwise noted)

Symbol	Min.	Typ.	Max.	Unit	Test Conditions
Static					
BV _{DSS}	-30	-	-	V	V _{GS} =0, I _D =-250μA
V _{GS(th)}	-1	-1.5	-3	V	V _{DS} =V _{GS} , I _D =-250μA
I _{GSS}	-	-	±100	nA	V _{GS} =±20V, V _{DS} =0
I _{DSS}	-	-	-1	μA	V _{DS} =-24V, V _{GS} =0
I _{DSS}	-	-	-10	μA	V _{DS} =-20V, V _{GS} =0, T _j =125°C
R _{DS(ON)} (Note 1)	-	7.7	9	mΩ	I _D =-15A, V _{GS} =-10V
	-	11.4	18		I _D =-10A, V _{GS} =-4.5V
G _{FS} (Note 1)	-	28	-	S	V _{DS} =-5V, I _D =-15A
Dynamic					
C _{iss}	-	4022	-	pF	V _{DS} =-15V, V _{GS} =0, f=1MHz
C _{OSS}	-	498	-		
C _{rSS}	-	442	-		
t _{d(ON)} (Note 1&2)	-	21	-	ns	V _{DS} =-15V, I _D =-15A, V _{GS} =-10V, R _G =3 Ω
t _r (Note 1&2)	-	19	-		
t _{d(OFF)} (Note 1&2)	-	57	-		
t _f (Note 1&2)	-	22	-		
Q _g (V _{GS} =10V) (Note 1&2)	-	56	-	nC	V _{DS} =-15V, I _D =-15A, V _{GS} =-10V
Q _g (V _{GS} =4.5V) (Note 1&2)	-	36	-		
Q _{gs} (Note 1&2)	-	15	-		
Q _{gd} (Note 1&2)	-	18	-		
R _g	-	3	-	Ω	V _{GS} =15mV, V _{DS} =0, f=1MHz



Electrical Characteristics(Cont.) (Tj=25°C, unless otherwise specified)

Symbol	Min.	Typ.	Max.	Unit	Test Conditions
Source-Drain Diode					
Is	-	-	-10	A	
ISM(Note 3)	-	-	-40		
VSD(Note 1)	-	-0.81	-1.2	V	IF=IS, VGS=0V
trr	-	32	-	ns	IF=-10A, dIF/dt=100A/μs
Qrr	-	26	-	nC	

Note : 1.Pulse Test : Pulse Width ≤300μs, Duty Cycle≤2%
 2.Independent of operating temperature
 3.Pulse width limited by maximum junction temperature

Thermal Resistance Ratings

Thermal Resistance	Symbol	Typical	Maximum	Unit
Junction-to-Case	RθJC		25	°C / W
Junction-to-Ambient (Note)	RθJA		40	

Note : W when mounted on a 1 in² pad of 2 oz copper, t≤10s; 125°C/W when mounted on minimum copper pad.

Ordering Information

Device	Package	Shipping
MTP4409Q8-0-T1-G	SOP-8 (Pb-free lead plating and halogen-free package)	2500 pcs/ Tape & Reel

Typical Characteristics

Typical Output Characteristics

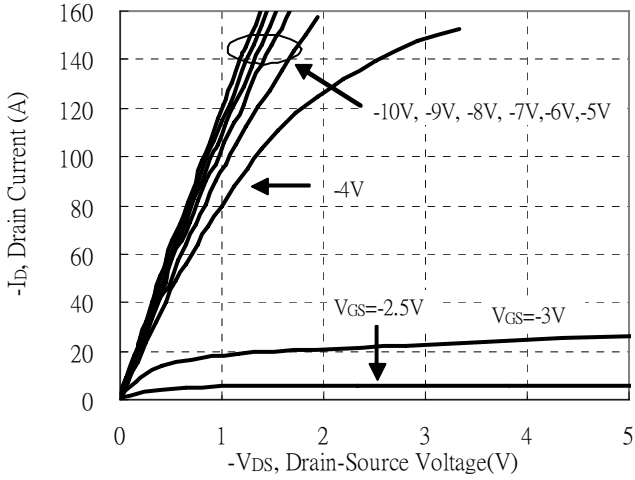

Normalized Brekdown Voltage vs Ambient Temperature

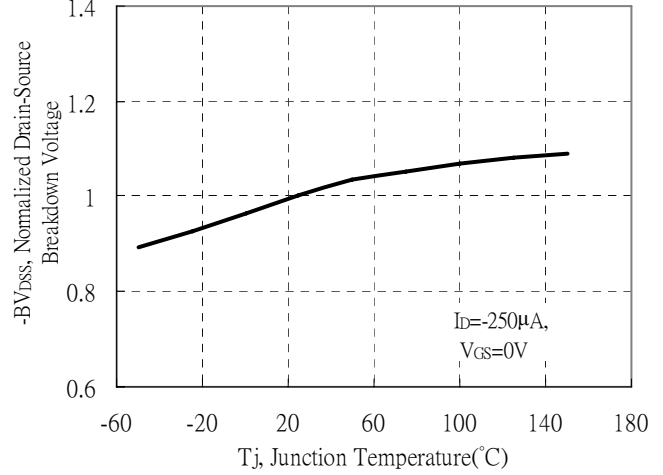

Static Drain-Source On-State resistance vs Drain Current

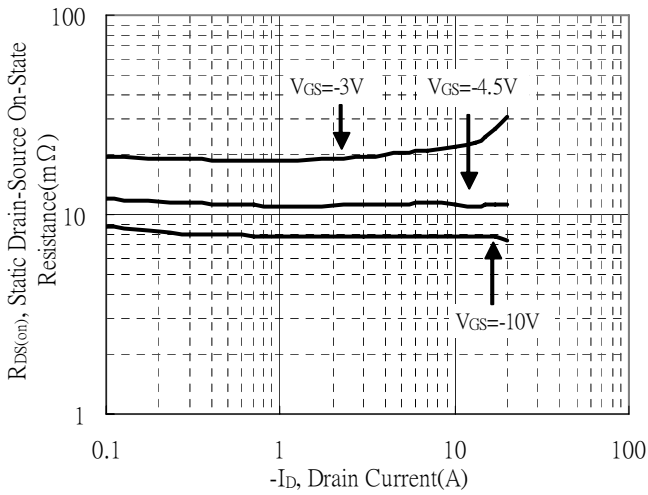

Source Drain Current vs Source-Drain Voltage

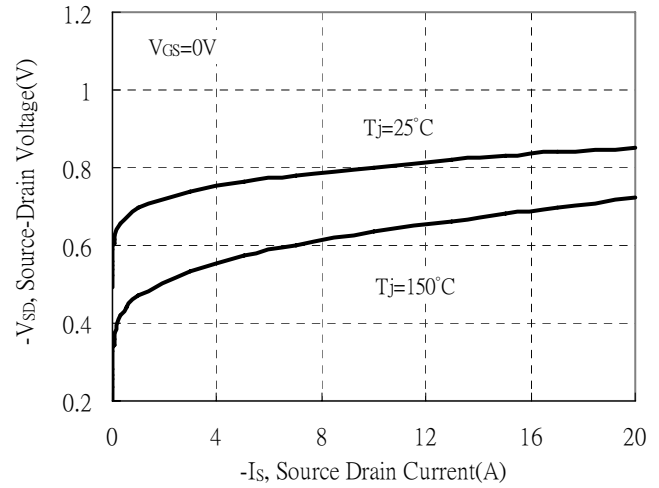

Static Drain-Source On-State Resistance vs Gate-Source Voltage

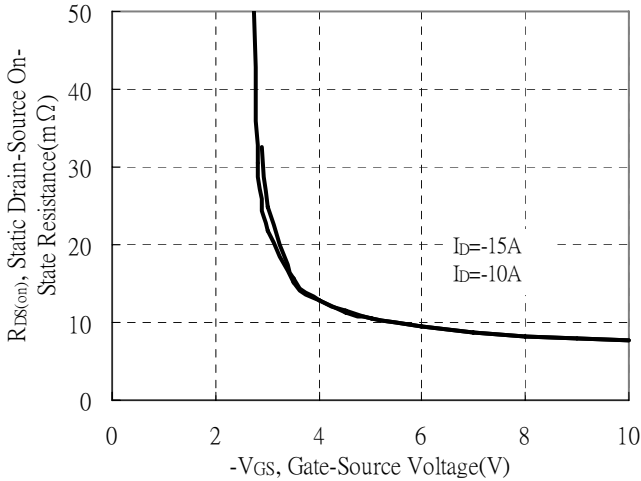

Normalized Drain-Source On-State Resistance vs Junction Temperature

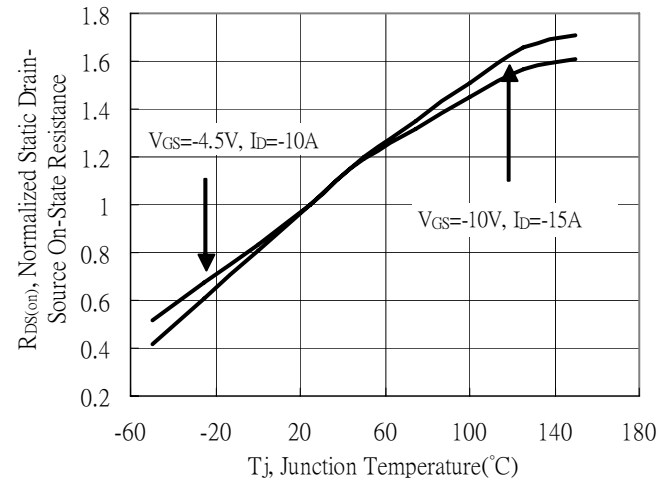

Typical Characteristics(Cont.)

Capacitance vs Drain-to-Source Voltage

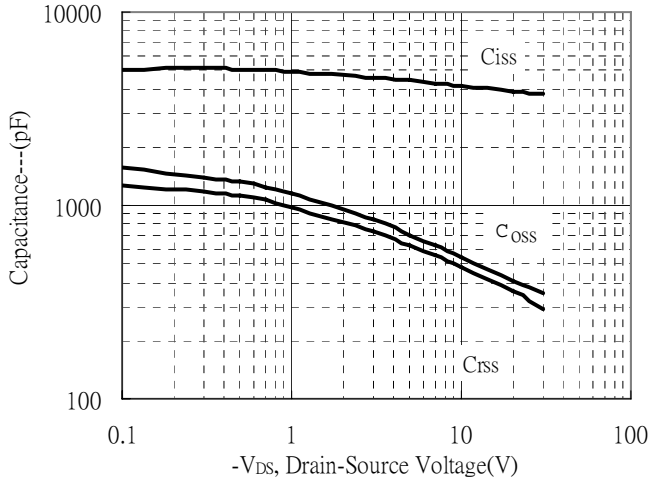

Normalized Threshold Voltage vs Junction Temperature

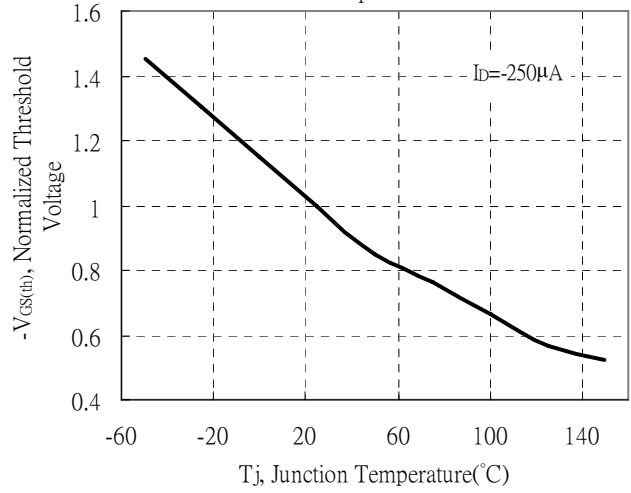

Forward Transfer Admittance vs Drain Current

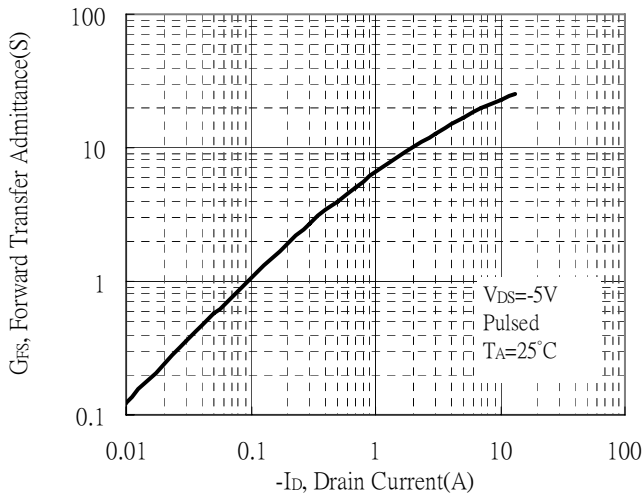

Gate Charge Characteristics

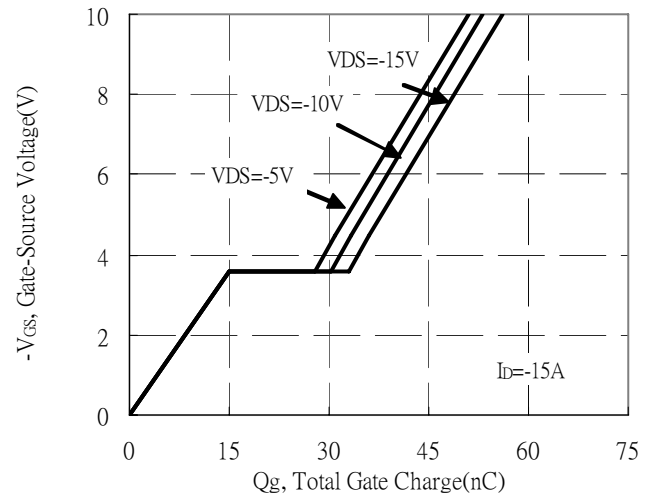

Maximum Safe Operating Area

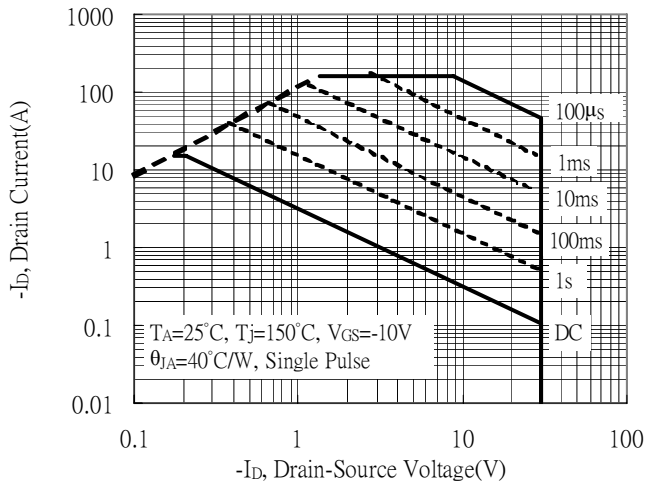

Maximum Drain Current vs Junction Temperature

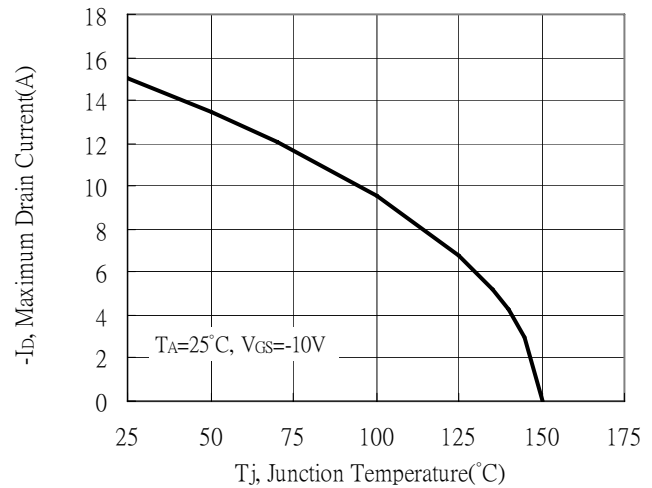



Typical Characteristics(Cont.)

Single Pulse Power Rating, Junction to Ambient
 (Note on page 2)

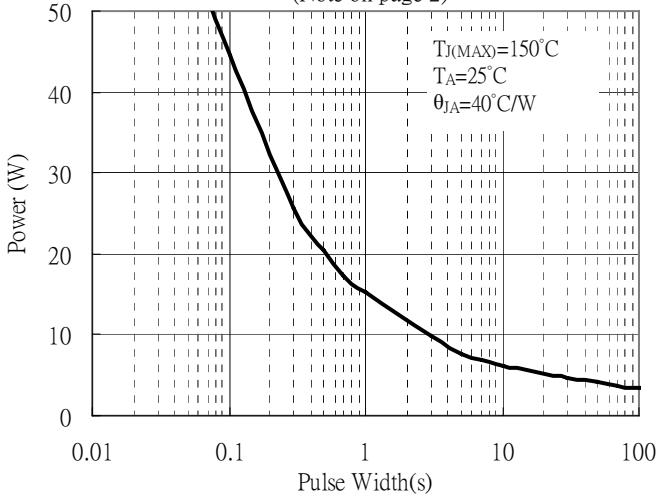

Transient Thermal Response Curves

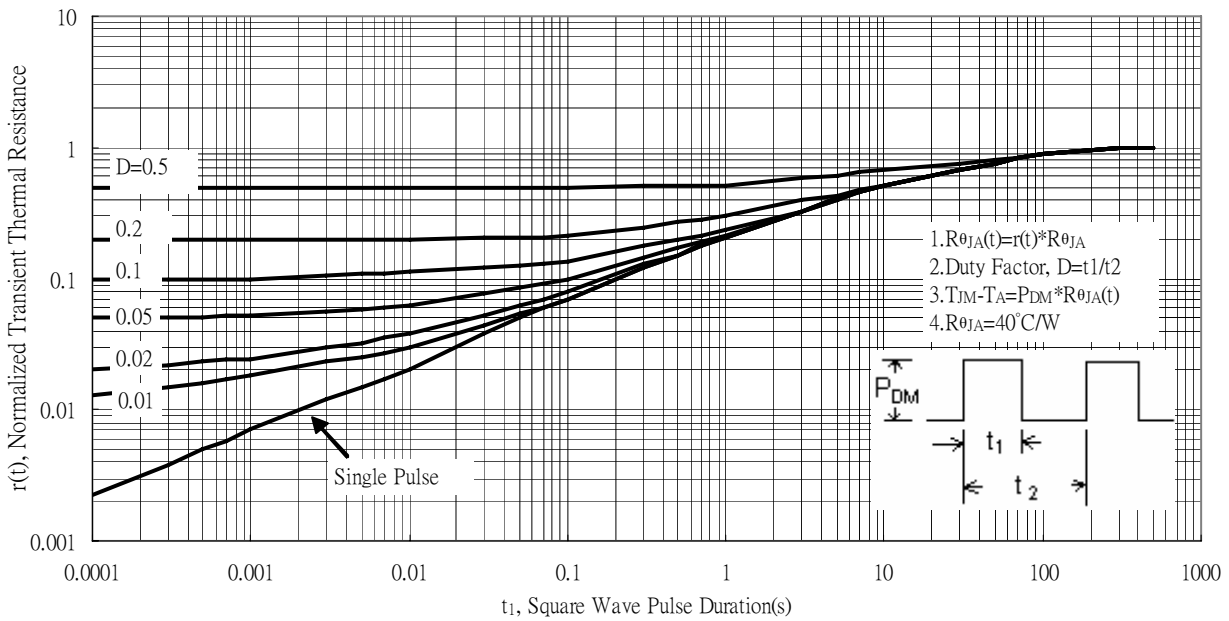

Reel Dimension

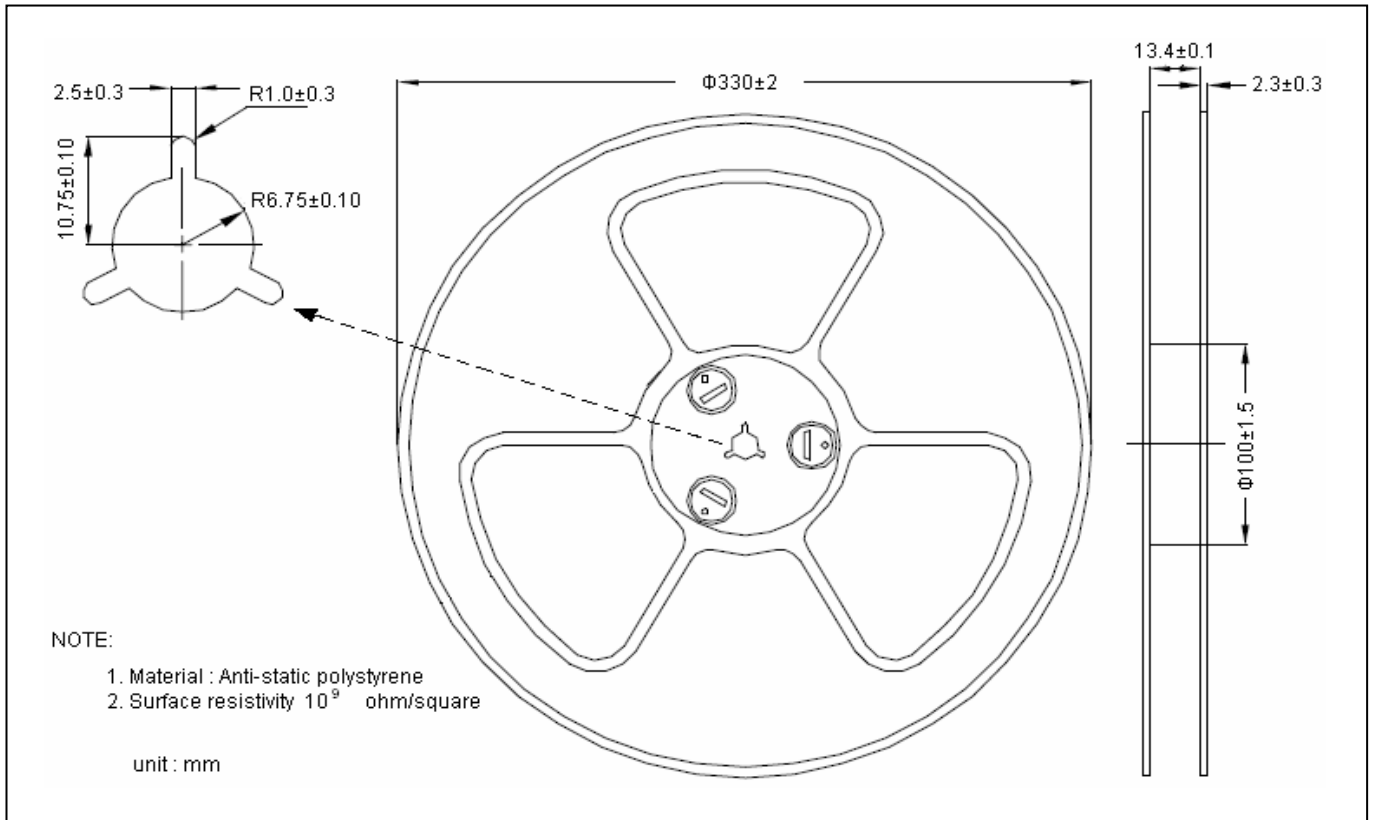

Carrier Tape Dimension

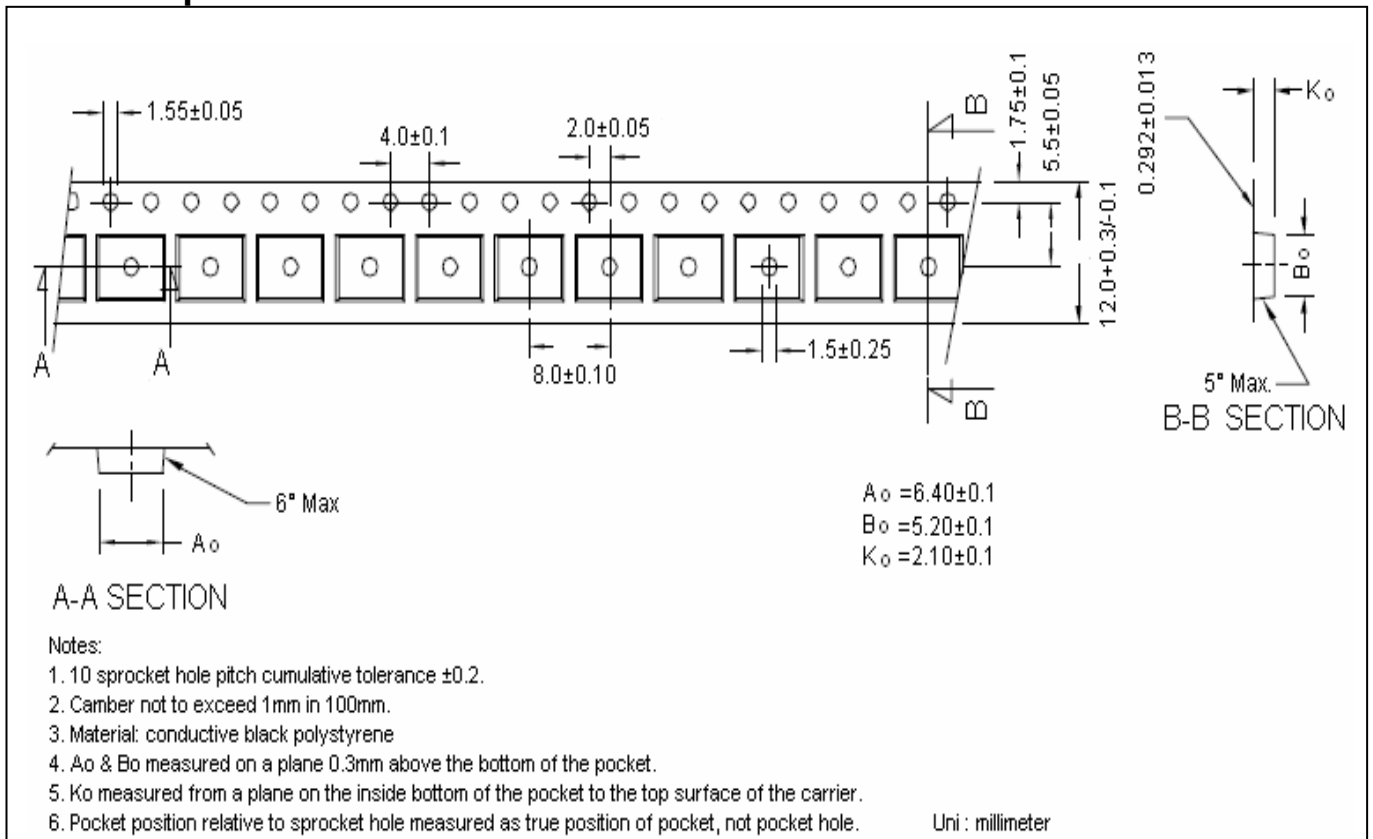

Recommended wave soldering condition

Product	Peak Temperature	Soldering Time
Pb-free devices	260 +0/-5 °C	5 +1/-1 seconds

Recommended temperature profile for IR reflow

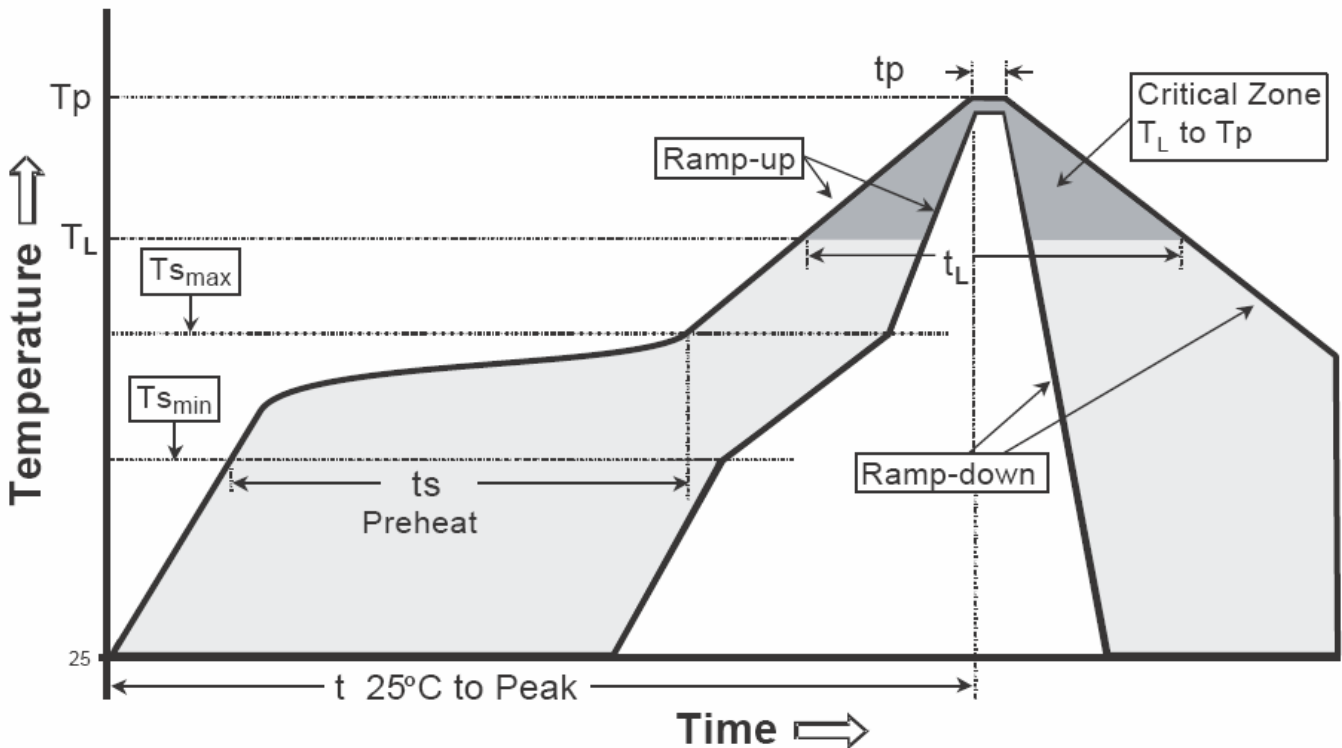

Profile feature	Sn-Pb eutectic Assembly	Pb-free Assembly
Average ramp-up rate (T _{smax} to T _p)	3°C/second max.	3°C/second max.
Preheat		
-Temperature Min(T _{s min})	100°C	150°C
-Temperature Max(T _{s max})	150°C	200°C
-Time(t _{s min} to t _{s max})	60-120 seconds	60-180 seconds
Time maintained above:		
-Temperature (T _L)	183°C	217°C
- Time (t _L)	60-150 seconds	60-150 seconds
Peak Temperature(T _P)	240 +0/-5 °C	260 +0/-5 °C
Time within 5°C of actual peak temperature(tp)	10-30 seconds	20-40 seconds
Ramp down rate	6°C/second max.	6°C/second max.
Time 25 °C to peak temperature	6 minutes max.	8 minutes max.

Note : All temperatures refer to topside of the package, measured on the package body surface.

SOP-8 Dimension

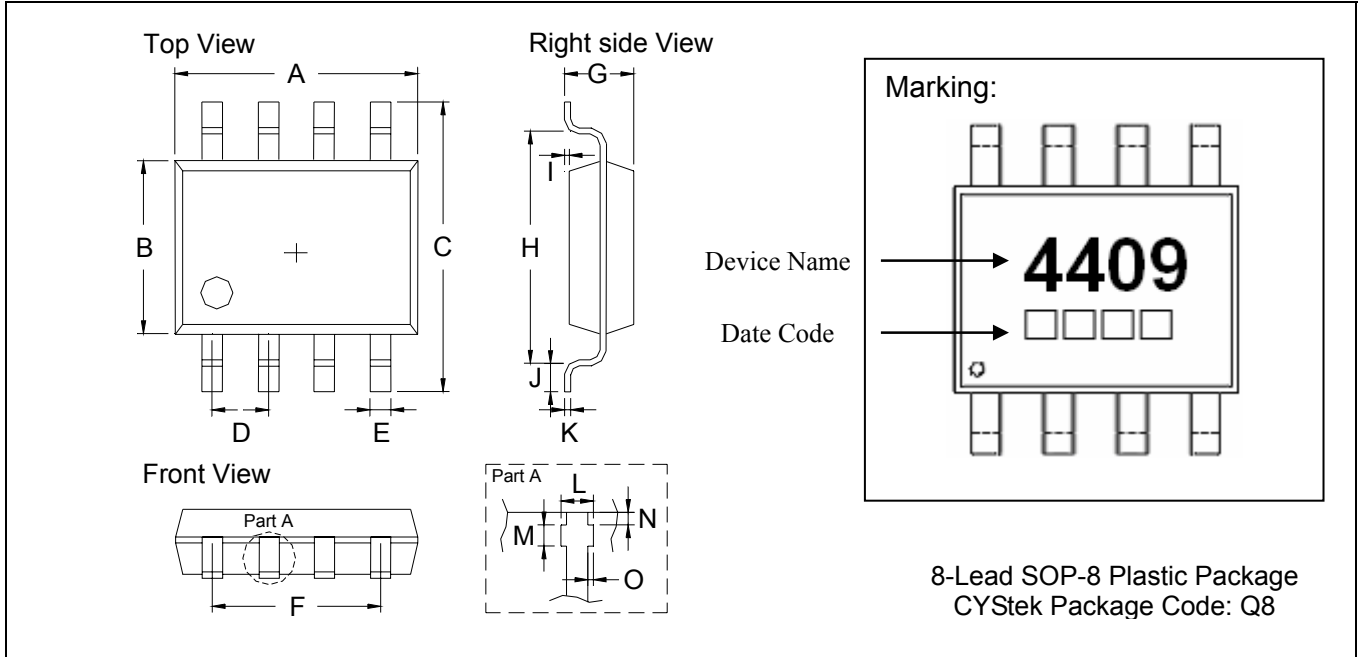

*: Typical

DIM	Inches		Millimeters		DIM	Inches		Millimeters	
	Min.	Max.	Min.	Max.		Min.	Max.	Min.	Max.
A	0.1909	0.2007	4.85	5.10	I	0.0019	0.0078	0.05	0.20
B	0.1515	0.1555	3.85	3.95	J	0.0118	0.0275	0.30	0.70
C	0.2283	0.2441	5.80	6.20	K	0.0074	0.0098	0.19	0.25
D	0.0480	0.0519	1.22	1.32	L	0.0145	0.0204	0.37	0.52
E	0.0145	0.0185	0.37	0.47	M	0.0118	0.0197	0.30	0.50
F	0.1472	0.1527	3.74	3.88	N	0.0031	0.0051	0.08	0.13
G	0.0570	0.0649	1.45	1.65	O	0.0000	0.0059	0.00	0.15
H	0.1889	0.2007	4.80	5.10					

Notes: 1. Controlling dimension: millimeters.
 2. Maximum lead thickness includes lead finish thickness, and minimum lead thickness is the minimum thickness of base material.
 3. If there is any question with packing specification or packing method, please contact your local CYStek sales office.

Material:

- Lead: Pure tin plated.
- Mold Compound: Epoxy resin family, flammability solid burning class: UL94V-0.

Important Notice:

- All rights are reserved. Reproduction in whole or in part is prohibited without the prior written approval of CYStek.
- CYStek reserves the right to make changes to its products without notice.
- CYStek **semiconductor products are not warranted to be suitable for use in Life-Support Applications, or systems.**
- CYStek assumes no liability for any consequence of customer product design, infringement of patents, or application assistance.