

**FAIRCHILD**

A Schlumberger Company

IRF510-513

MTP4N08/4N10

N-Channel Power MOSFETs,  
5.5 A, 60-100 V

Power And Discrete Division

T-39-09

T-39-11

**Description**

These devices are n-channel, enhancement mode, power MOSFETs designed especially for high speed applications, such as switching power supplies, converters, AC and DC motor controls, relay and solenoid drivers and other pulse circuits.

- Low  $R_{DS(on)}$
- $V_{GS}$  Rated at  $\pm 20$  V
- Silicon Gate for Fast Switching Speeds
- $I_{BSS}$ ,  $V_{DS(on)}$ , Specified at Elevated Temperature
- Rugged
- Low Drive Requirements
- Ease of Paralleling

TO-220AB

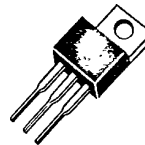

IS00010F

IRF510  
IRF511  
IRF512  
IRF513  
MTP4N08  
MTP4N10

**Maximum Ratings**

Symbol	Characteristic	Rating IRF510/512 MTP4N10	Rating MTP4N08	Rating IRF511/513	Unit
$V_{DSS}$	Drain to Source Voltage <sup>1</sup>	100	80	60	V
$V_{DGR}$	Drain to Gate Voltage <sup>1</sup> $R_{GS} = 20 \text{ k}\Omega$	100	80	60	V
$V_{GS}$	Gate to Source Voltage	$\pm 20$	$\pm 20$	$\pm 20$	V
$T_J, T_{stg}$	Operating Junction and Storage Temperatures	-55 to +150	-55 to +150	-55 to +150	$^{\circ}\text{C}$
$T_L$	Maximum Lead Temperature for Soldering Purposes, 1/8" From Case for 5 s	275	275	275	$^{\circ}\text{C}$

**Maximum On-State Characteristics**

		IRF510/511	IRF512/513	MTP4N08/10	
$R_{DS(on)}$	Static Drain-to-Source On Resistance	0.60	0.80	0.80	$\Omega$
$I_D$	Drain Current				A
	Continuous at $T_C = 25^{\circ}\text{C}$	4.0	3.5	5.0	
	Continuous at $T_C = 100^{\circ}\text{C}$	2.5	2.0	3.5	
	Pulsed	16	14	14	

**Maximum Thermal Characteristics**

$R_{\theta JC}$	Thermal Resistance, Junction to Case	6.4	6.4	2.5	$^{\circ}\text{C}/\text{W}$
$R_{\theta JA}$	Thermal Resistance, Junction to Ambient	80	80	80	$^{\circ}\text{C}/\text{W}$
$P_D$	Total Power Dissipation at $T_C = 25^{\circ}\text{C}$	20	20	50	W

**Notes**

For information concerning connection diagram and package outline, refer to Section 7.

IRF510-513  
MTP4N08/4N10

T.39-09

T.39-11

**Electrical Characteristics** ( $T_C = 25^\circ\text{C}$  unless otherwise noted)

Symbol	Characteristic	Min	Max	Unit	Test Conditions
<b>Off Characteristics</b>					
$V_{(BR)DSS}$	Drain Source Breakdown Voltage <sup>1</sup>			V	$V_{GS} = 0\text{ V}, I_D = 250\ \mu\text{A}$
	IRF510/512/MTP4N10	100			
	MTP4N08	80			
	IRF511/513	60			
$I_{DSS}$	Zero Gate Voltage Drain Current		250	$\mu\text{A}$	$V_{DS} = \text{Rated } V_{DSS}, V_{GS} = 0\text{ V}$
			1000	$\mu\text{A}$	$V_{DS} = 0.8 \times \text{Rated } V_{DSS}, V_{GS} = 0\text{ V}, T_C = 125^\circ\text{C}$
$I_{GSS}$	Gate-Body Leakage Current		$\pm 500$	nA	$V_{GS} = \pm 20\text{ V}, V_{DS} = 0\text{ V}$
<b>On Characteristics</b>					
$V_{GS(th)}$	Gate Threshold Voltage			V	$I_D = 250\ \mu\text{A}, V_{DS} = V_{GS}$
	IRF510-513	2.0	4.0		
	MTP4N08/10	2.0	4.5		
$R_{DS(on)}$	Static Drain-Source On-Resistance <sup>2</sup>			$\Omega$	$V_{GS} = 10\text{ V}, I_D = 2.0\text{ A}$
	IRF510/511		0.60		
	IRF512/513/MTP4N08/4N10		0.80		
$V_{DS(on)}$	Drain-Source On-Voltage <sup>2</sup>		4.8	V	$V_{GS} = 10\text{ V}; I_D = 4.0\text{ A}$
	MTP4N08/4N10		3.2	V	$V_{GS} = 10\text{ V}; I_D = 2.0\text{ A}; T_C = 100^\circ\text{C}$
$g_{fs}$	Forward Transconductance	1.0		S ( $\Omega$ )	$V_{DS} = 10\text{ V}, I_D = 2.0\text{ A}$
<b>Dynamic Characteristics</b>					
$C_{iss}$	Input Capacitance		200	pF	$V_{DS} = 25\text{ V}, V_{GS} = 0\text{ V}$ $f = 1.0\text{ MHz}$
$C_{oss}$	Output Capacitance		100	pF	
$C_{rss}$	Reverse Transfer Capacitance		30	pF	
<b>Switching Characteristics</b> ( $T_C = 25^\circ\text{C}$ , Figures 11, 12) <sup>3</sup>					
$t_{d(on)}$	Turn-On Delay Time		20	ns	$V_{DD} = 50\text{ V}, I_D = 2.0\text{ A}$ $V_{GS} = 10\text{ V}, R_{GEN} = 50\ \Omega$ $R_{GS} = 50\ \Omega$
$t_r$	Rise Time		25	ns	
$t_{d(off)}$	Turn-Off Delay Time		25	ns	
$t_f$	Fall Time		20	ns	
$Q_g$	Total Gate Charge		7.5	nC	$V_{GS} = 10\text{ V}, I_D = 8.0\text{ A}$ $V_{DD} = 40\text{ V}$

IRF510-513  
MTP4N08/4N10

T-39-09

T-39-11

Electrical Characteristics (Cont.) ( $T_C = 25^\circ\text{C}$  unless otherwise noted)

Symbol	Characteristic	Typ	Max	Unit	Test Conditions
<b>Source-Drain Diode Characteristics</b>					
$V_{SD}$	Diode Forward Voltage			V	$I_S = 4.0 \text{ A}; V_{GS} = 0 \text{ V}$
	IRF510/511		2.5		
	IRF512/513		2.0		$I_S = 3.5 \text{ A}; V_{GS} = 0 \text{ V}$
$t_{rr}$	Reverse Recovery Time	230		ns	$I_S = 4.0 \text{ A}; dI_S/dt = 25 \text{ A}/\mu\text{S}$

Notes

- $T_J = +25^\circ\text{C}$  to  $+150^\circ\text{C}$
- Pulse test: Pulse width  $\leq 80 \mu\text{s}$ , Duty cycle  $\leq 1\%$
- Switching time measurements performed on LEM TR-58 test equipment

Typical Performance Curves

Figure 1 Output Characteristics

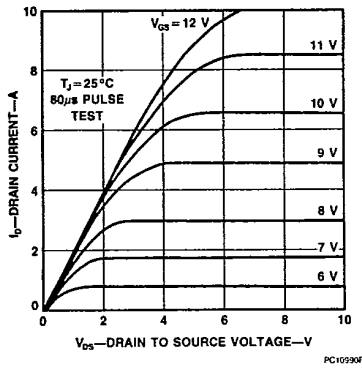

Figure 2 Static Drain to Source Resistance vs Drain Current

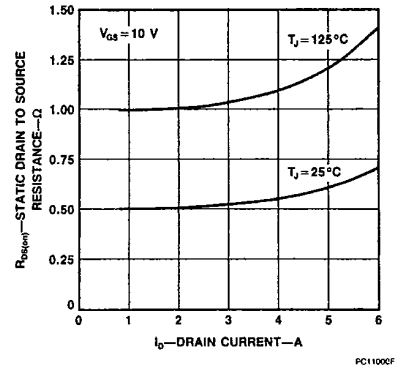

Figure 3 Transfer Characteristics

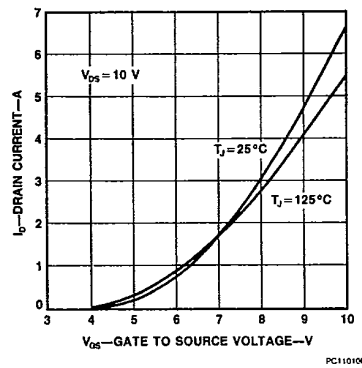
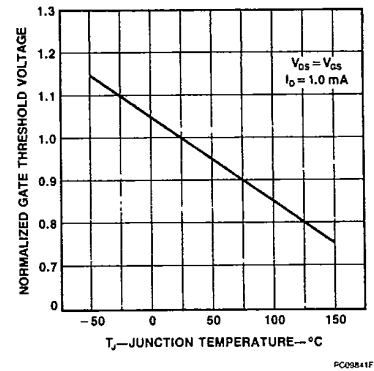

Figure 4 Temperature Variation of Gate to Source Threshold Voltage



Typical Performance Curves (Cont.)

Figure 5 Capacitance vs Drain to Source Voltage

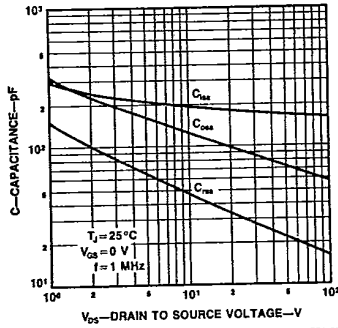

Figure 6 Gate to Source Voltage vs Total Gate Charge

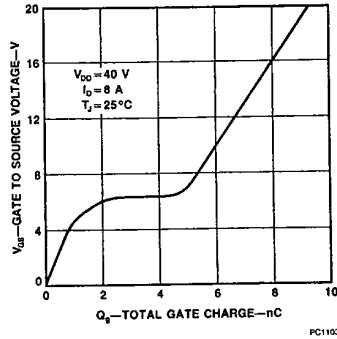

Figure 7 Forward Biased Safe Operating Area for MTP4N08/4N10

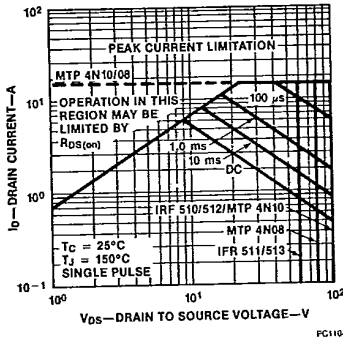

Figure 8 Transient Thermal Resistance vs Time for MTP4N08/4N10

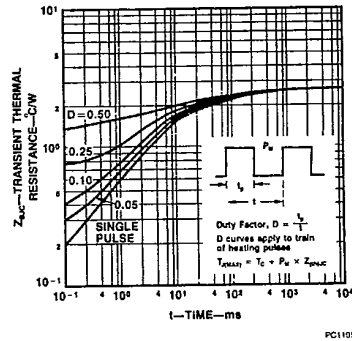

Figure 9 Forward Biased Safe Operating Area for IRF510-513

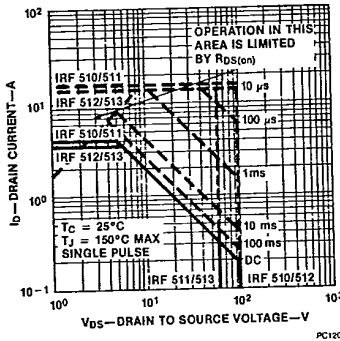
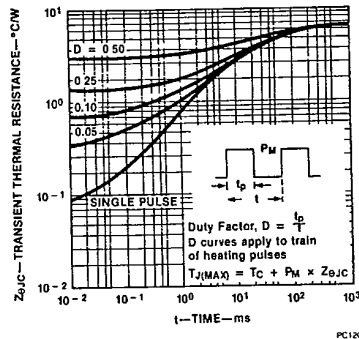

Figure 10 Transient Thermal Resistance vs Time for IRF510-513



IRF510-513  
MTP4N08/4N10

T-39-09  
T-39-11

Typical Electrical Characteristics

Figure 11 Switching Test Circuit

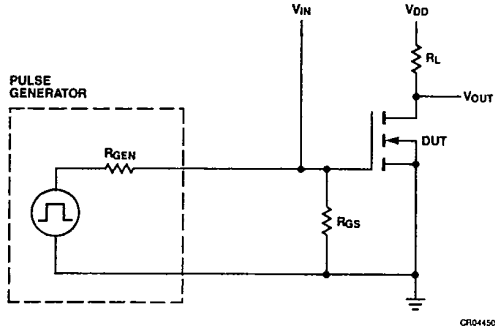

Figure 12 Switching Waveforms

