

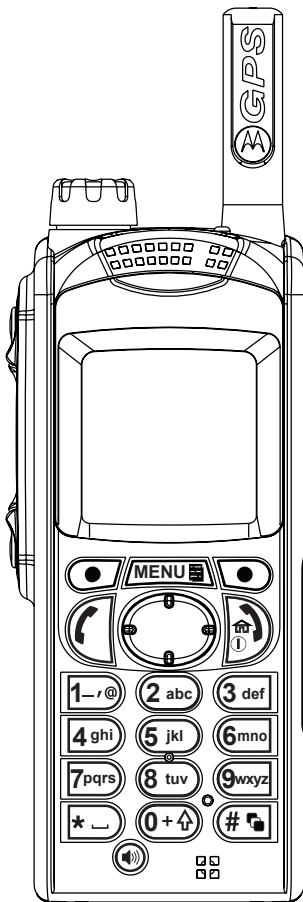

# MTP850

## TETRA Portable Terminal

## Basic User Guide



6866537D79-A

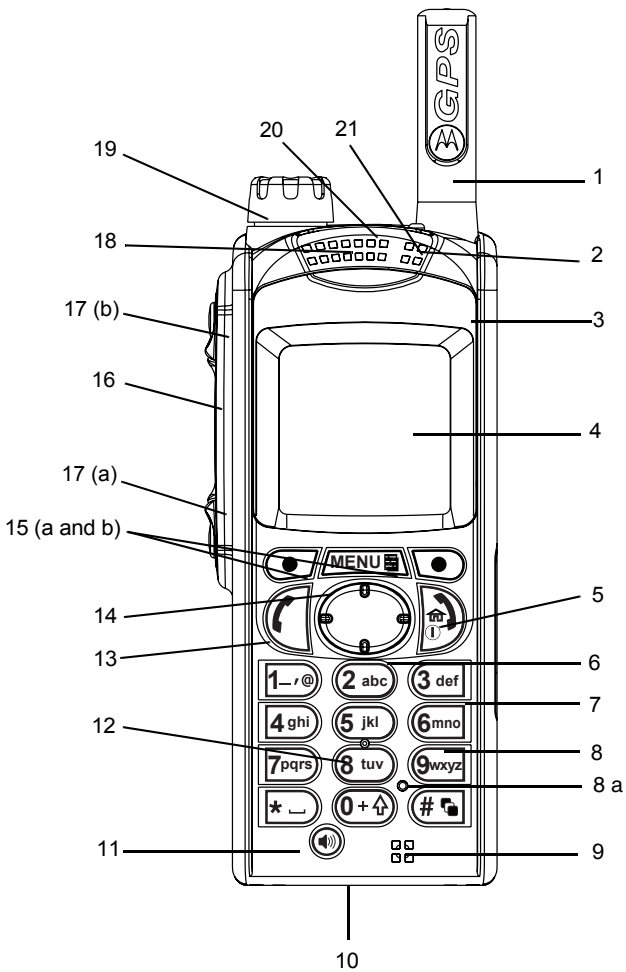

# Contents

---

<b>Safety Information</b> .....	<b>4</b>
<b>MTP850 Overview</b> .....	<b>5</b>
Controls and Indicators .....	5
Audio Signal Tones .....	7
Key, Knob, and Button Overview .....	10
On-Off/End/Home Key .....	10
Soft Keys .....	10
Menu Key .....	10
Rotary Knob .....	10
Emergency Button .....	10
Function Keys .....	11
Speaker Control Key .....	12
The LED Status Indicator .....	12
To Enter the Menu Items .....	12
To Return to the Previous Level .....	12
To Exit the Menu Items .....	12
List of Menu Items .....	13
The Display .....	15
Status Icons .....	15
Menu Icons .....	17
Inbox Icons .....	17
Contact Icons .....	18
Text Entry Icons .....	18
<b>Getting Started</b> .....	<b>20</b>
Battery .....	20
Installing the Battery .....	20
Replacing the Battery .....	20
Charging the Battery .....	21
Battery Capacity Information .....	21
Attaching the Antenna .....	22
Powering On/Off (On-Off/End/Home Key) .....	22
Powering On (Emergency Button) .....	22
Powering On with Transmit Inhibit (TXI) Active .....	22

Unlocking the MTP850 .....	23
Locking/Unlocking the Keypad .....	23
<b>Selecting TMO or DMO Operation .....</b>	<b>24</b>
Entering TMO or DMO .....	24
<b>Group Calls .....</b>	<b>25</b>
“My Groups” Folder .....	25
Selecting the “My Groups” Folder .....	25
Adding a Group (TMO/DMO) to the “My Groups” Folder ..	25
Selecting a Group .....	25
Using the Rotary Knob .....	25
Using the Navigation Key .....	25
Using Alphabetic Search .....	26
Using Folder Search .....	26
Selecting a Folder .....	26
TMO Group Calls .....	26
Making a TMO Group Call .....	26
Receiving a TMO Group Call .....	26
Receiving a TMO Broadcast Call .....	27
DMO Group Calls .....	27
Making a DMO Group Call .....	27
Receiving a DMO Group Call .....	27
Exiting DMO .....	27
<b>Private, Phone, and PABX Calls .....</b>	<b>28</b>
Creating a Contact .....	28
How to Dial .....	28
Dialing a Number .....	28
Dialing via the Contact List .....	28
Private Call .....	29
Making a Private Call .....	29
Receiving a Private Call .....	29
Phone and PABX Calls .....	30
Making a Phone or PABX Call .....	30
<b>Emergency Mode .....</b>	<b>31</b>
Entering or Exiting Emergency Mode .....	31
Sending an Emergency Alarm (TMO Only) .....	31
Hot Microphone Feature .....	32

Making an Emergency Group Call .....	32
<b>Messages .....</b>	<b>33</b>
Sending a Status Message .....	33
Sending a New Message .....	33
Sending a User-defined Message .....	33
Sending a Predefined Message .....	33
Handling New Incoming Text Messages .....	33
Handling Unread (New) Messages .....	34
<b>Tips &amp; Tricks .....</b>	<b>35</b>
<b>Quick Reference Guide .....</b>	<b>39</b>

© Motorola Inc., 2005

MOTOROLA and the stylized M Logo are registered in the U.S. Patent and Trademark Office. All other product or service names are the property of their respective.

# Safety Information

---

This user guide covers the basic operation of the MTP850 Handportable Terminal. Please consult your dealer for further, more detailed information which is contained in the feature user guide 6866537D80\_.



Caution

Before using this product, read the operating instructions for safe usage contained in the Product Safety and RF Exposure booklet 6864117B25\_ enclosed with your MTP850.

## ATTENTION!

The MTP850 is restricted to occupational use only to satisfy ICNIRP RF energy exposure requirements. Before using this product, read the RF energy awareness information and operating instructions in the Product Safety and RF Exposure booklet (Motorola Publication part number 6864117B25\_) to ensure compliance with RF energy exposure limits.

Keep this **User Guide** and the **Product Safety and RF Exposure booklet** in a safe place and make it available to other operators in case the MTP850 is passed on to other people.

## Copyright Information

The Motorola products described in this manual may include copyrighted Motorola computer programs stored in semiconductor memories or other mediums. Laws in the United States and other countries preserve for Motorola certain exclusive rights for copyrighted computer programs, including the exclusive right to copy or reproduce in any form the copyrighted computer program. Accordingly, any copyrighted Motorola computer programs contained in the Motorola products described in this manual may not be copied or reproduced in any manner without the express written permission of Motorola. Furthermore, the purchase of Motorola products shall not be deemed to grant either directly or by implication, estoppel, or otherwise, any licence under the copyrights, patents, or patent applications of Motorola, except for the normal non-exclusive royalty-free licence to use that arises by operation of the law in the sale of a product.

# MTP850 Overview

---

## Controls and Indicators

The numbers below refer to the illustration on the inside front cover.

Number	Description
1	Antenna
2	Top Microphone Activated during half-duplex, high-audio calls such as Group Calls.
3	External Antenna Connector Used with the digital car kit to connect the RF signal to the external antenna. (At the back of the MTP850)
4	Colour Display Provides alphanumeric text and images within 65,536 colours and 130 x 130 pixels with backlight, scalable fonts, and contrast.
5	On-Off/End//Home Key Press and hold to turn the MTP850 On/Off. Press to end calls. Press to return to the Home display (idle screen).
6	Four-Way Navigation Key Press up, down, left or right for list scrolling, while moving around the menu hierarchy, or for alphanumeric text editing.
7	Audio Accessory Connector (At the side of the MTP850)
8	Alphanumeric Keypad Use the keypad to enter alphanumeric characters for dialing, contact entries and text messages.
8 a	Sensor for keypad backlight On/Off
9	Bottom Microphone Activated during half-duplex and full-duplex, low-audio calls such as Phone Calls.
10	Accessory Connector Provides connection for accessories. (At the base of the MTP850)
11	Speaker Control Key Selects earpiece (low audio) or speaker (high audio).
12	Speaker (under keypad)
13	Send Key Used to initiate or answer full-duplex calls (such as Phone Calls), or send status and text messages.

Number	Description
14	Menu Key Used to enter the main menu and the context sensitive menu.
15	Soft Key(s) Press to select the option that appears in the display directly above the left or right soft key.
16	Push-To-Talk Button (PTT) Press and hold this side button to talk in half-duplex calls, release it to listen. Press to send status and text messages.
17	Programmable Side Keys 1 and 2 Default programming: upper Side key activates/deactivates Backlight; lower Side key activates Screen Saver. (See also No. 19)
18	Earpiece
19	Programmable Rotary Knob Default programming: "Dual" - Press the knob to toggle between "volume" and "list". Side keys (No. 17) operate as programmed.
20	Emergency Button (on top of the MTP850). Press and hold to enter Emergency Mode, and send Emergency Alarms (as programmed). When the MTP850 is Off, press and hold to power on in Emergency Mode or in normal mode (as programmed).
21	LED (Indicator)











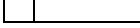

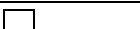
*Before using your MTP850 for the first time, remove the plastic lens protector from the display, and charge the battery overnight to ensure battery is initialised to its full capacity.*

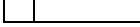









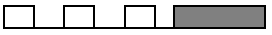





## Audio Signal Tones

□ = High Tone; ■ = Low Tone;

Description	Type	Repeated
<b>Idle</b>		
<ul style="list-style-type: none"> <li>• Back to Home display</li> <li>• Back to rotary volume use when rotary scroll timer expires</li> <li>• Back to coverage</li> <li>• Back to full service</li> </ul>		Once
Clear-to-send		Once
Bad key press		Once
<ul style="list-style-type: none"> <li>• Good key press</li> <li>• MTP850 self-test fails at power up</li> <li>• From out-of-service to in-service</li> </ul>		Once
<b>In Call</b>		
Call clear warning		Once
Call waiting tone while Phone or Private Call are pending.		Every 6 seconds, until a call is terminated.
Data connected or Data disconnected		Once
Talk permit sounds upon pressing the PTT.		Once (Normal Tone)
		Once (Short Tone)
Talk permit without gateway sounds upon pressing PTT. The tone indicates the gateway is no longer available.		Twice
		Once
<ul style="list-style-type: none"> <li>• Talk prohibit</li> <li>• System busy</li> <li>• Time-out timer expire</li> <li>• Called MTP850 not available or busy</li> </ul>		Until you release the PTT.

Description	Type	Repeated
<ul style="list-style-type: none"> <li>Call disconnected or failed due to network</li> <li>Wrong number dialed</li> </ul>		Once
DMO (Direct Mode) Entering		Once
DMO Exiting		Once
Local site trunking — entering/exiting		Once
Phone ring back (sending)		Every three seconds, until the called user answers or call is rejected.
Phone busy		Every 0.5 seconds
Status message sent to the dispatcher or failed.		Twice
<b>Incoming Calls</b>		
Status message acknowledged by the dispatcher.		Four times
Your MTP850 received a Group Call without gateway (setup only).		Once
High-priority Group Call received		Once
Emergency Alarm sent or received		Twice
Emergency Alarm failed		Four times
Emergency Call received		Once
Phone ring (reception) full-duplex Private Call		Until you answer or the call is rejected.
Private Call received		Until the call is answered.
Private Call ringing to the caller		Until the call is answered.
Half-duplex Private Pre-emptive Priority Call (PPC) ring		Every 4 seconds, until the call is answered or rejected.



Description	Type	Repeated
Full-duplex Private PPC ring		Every 4 seconds, until the call is answered or rejected.
Limited service		Once, upon entering limited service.
New mail received		Once
New Group Call		Once
<b>Battery/General</b>		
Volume setting (earpiece, keypad, speaker)		Continuous
Volume setting (ringer)		While setting the volume.
Transmit Inhibit (TXI)		Once
Rotary knob tone		Once, when toggling from list control to volume control.
Low battery alert		Repeated
DTMF (Dual Tone Multi-Frequency), keys  -  ,  , 	DTMF 	Continuous, until you release the key.

# Key, Knob, and Button Overview

## On-Off/End/Home Key

- Press and hold to turn the MTP850 On/Off.
- Press to end calls.
- Press to return to the Home display.

## Soft Keys

Press  or  to select the option that appears in the display directly above the left or right soft key.

## Menu Key

Press  to enter:

- **The menu.** The MTP850 menus allow you to control your MTP850 settings.
- **Context sensitive menu** (when  icon is on) to view a list of items for the current menu.

## Rotary Knob

The Service Provider can program the Rotary knob to one of the following uses:

1. **Dual control** - the knob is used as both a volume control and to scroll through lists. Press the knob to toggle between volume and list control (default programming).
2. **List control** - the knob is used to scroll lists (e.g. Talk group lists) or menu items. In this case volume control is always via the Side keys.
3. **Volume control** - the knob is used only as a volume control; turn clockwise to increase the audio volume level.

Press and hold the Rotary knob to lock it, press and hold it again to unlock. Powering Off also unlocks a locked Rotary knob.

## Emergency Button

Press and hold this button to enter Emergency Mode.

When the MTP850 is powered down, press and hold this button to power On in Emergency Mode or in standard mode (as programmed).

## Function Keys



For information on the function assigned to each Side or Numeric key, please refer to your Service Provider.



The required time you need to press the Side or Numeric keys to activate a one-touch function is set as default to 1 second. This time may be set, however, by your Service Provider.

## Side Keys

The Rotary knob and Side key programming are paired:.

Rotary Knob Programming	Side Key Programming
Dual control	Programmed to a one-touch function
List control	○ : Volume Up ● : Volume Down
Volume control	Programmed to a one-touch function

When the Rotary knob is programmed to volume control or dual control, the Side keys support the one-touch feature that allows you to select or activate commonly used features by pressing and holding a single key. By default, the upper Side key is set to “Backlight On/Off” and the lower Side key is set to “Screen Saver On”. Please check with your Service Provider.

## Numeric Keys

The MTP850 supports the one-touch feature that allows you to select or activate commonly used features by pressing and holding a Numeric key.

## Speaker Control Key

Press  to activate the earpiece (low audio) or speaker (high audio), depending on the menu settings.

Type of Call	Menu Setting	Key Use
Half-duplex call (Group*/Private)	Menu > Setup > Group Audio > Spkr Cntrl	Speaker On/Off for Group and Private Calls
	Menu > Setup > Group Audio > Always Loud	Speaker On/Off for Private Call
Full-duplex call (Private/Phone/PABX)	-----	Controls speaker/earpiece of the on-going call.



\* In an Emergency Group Call, the voice sounds from the speaker regardless of the speaker setting.

## The LED Status Indicator

The LED indicator shows the states of your MTP850.

Indicator	Status
Solid green	In use
Flashing green	In service
Solid red	Out of service
Flashing red	Connecting to a network/Entering DMO
Solid orange	Transmit Inhibit (TXI) in service / Channel busy in DMO
Flashing orange	Incoming call
No indication	Switched off

## To Enter the Menu Items

1. Press .
2. Scroll to the required item, press **Select** or  to select.

## To Return to the Previous Level

Press **Back** or .

## To Exit the Menu Items

Press .



Your MTP850 may exit if no key press is detected for a time-out period.

# List of Menu Items

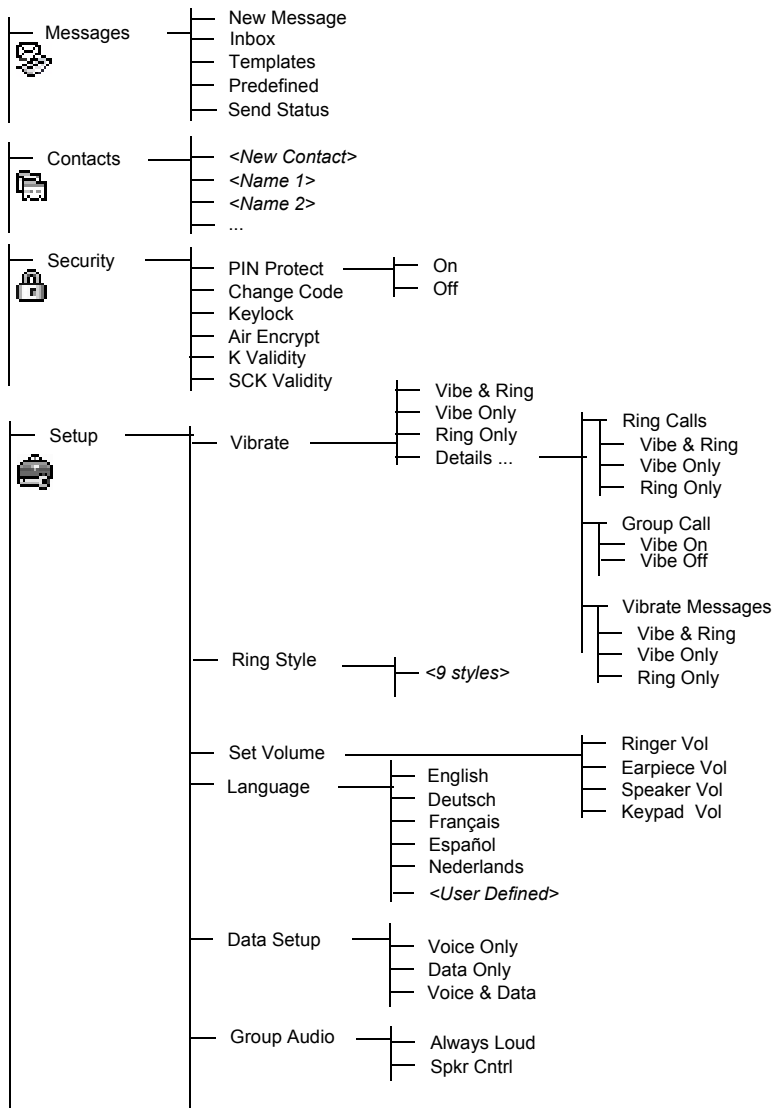

See next page

# List of Menu Items (Cont'd)

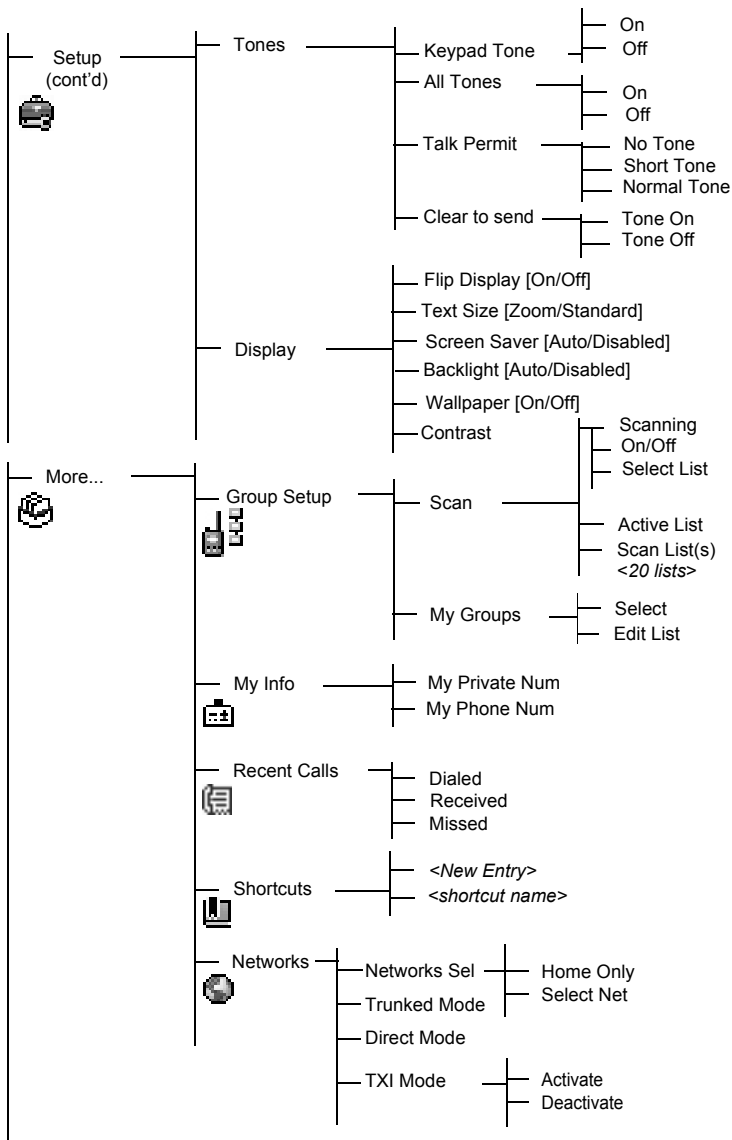





This is the standard menu layout. Your Service Provider may enable/disable some menu items or change their names.

## Creating Menu Shortcuts

Use shortcuts to access frequently-used menu items.

Menu Shortcut Creation

Navigate to the menu item and press and hold  as the item is highlighted.

Menu Shortcut List

To look for assigned shortcuts, press  and select **More > Shortcuts > <shortcut name>**.

Menu Shortcut Use





From Home display, press  and the Numeric key(s) assigned to the shortcut.













## The Display

When you use your MTP850, icons appear on the display to indicate the following conditions.

### Status Icons









Status icons appear when your phone is engaged in certain activities or when you have activated certain features.

Status Icon	Description
<b>Trunked Mode Operation (TMO)</b>	
	<b>Signal Strength</b> Allows you to check signal strength. More bars indicate a stronger signal.
	<b>No Service</b>
	<b>Scan</b> Indicates scanning is activated in the MTP850.
	<b>Data Connected</b> Displayed when the MTP850 is successfully connected to an external device and ready for data transfer.

Status Icon	Description
	<b>Data Transmit/Receive</b> Displayed when the MTP850 is transferring data to/ receiving data from the external device (laptop or desktop PC).
<b>Direct Mode Operation (DMO)</b>	
	<b>Signal Strength</b> Indicates an incoming Direct Mode Group Call.
	<b>Direct Mode</b> Displayed when the MTP850 is in Direct Mode.
	<b>DMO Gateway</b> Indicates that gateway is selected. The icon has three states: Solid—while the MTP850 is synchronised with the gateway. Flashing—while the MTP850 is not synchronised or during attachment. No icon—during a radio to radio call, i.e. not using a gateway.
<b>General Icons</b>	
	<b>All Tones Off</b> Indicates that all alert tones are off in the MTP850.
	<b>Vibrate On</b> Indicates that the MTP850 will vibrate to alert you of an incoming call.
	<b>Vibrate and Ring</b> Indicates that the MTP850 will vibrate and ring to alert you of an incoming call.
	<b>Speaker Off (Low Audio)</b> Indicates that the audio will sound through the earpiece. (See detailed explanation of Speaker Control key.)
	<b>Battery Strength</b> Shows the charge in your battery. Full icon is full charge.
	<b>Emergency</b> Appears while the MTP850 is in Emergency Mode.
	<b>List Scrolling</b> Displayed to indicate that the Rotary knob use is list scrolling, as long as this use is selected.
	<b>New Message Has Arrived</b> Indicates a new message just arrived.
	<b>New Message(s) in Inbox</b> Indicates that you have unread messages in your inbox.





## Menu Icons

The following icons make it easy to identify the menu items at first glance.

Menu Icon	Description
	<b>Main Menu Items/Context Sensitive Menu</b> Appears above  if the main menu items/context sensitive menu are active.
	<b>Messages</b> <ul style="list-style-type: none"> <li>• Send status messages,</li> <li>• Send short text messages (free text or according to user defined or predefined templates),</li> <li>• Receive messages in inbox.</li> </ul>
	<b>Contacts</b> Add, search, edit, or erase entries in the contact list.
	<b>Security</b> Lets you turn On/Off and verify security features, and change passwords.
	<b>Setup</b> Allows you to customise your MTP850.
	<b>More...</b> Contains more customisable menu items.
	<b>Scroll Bar</b> Indicates navigation among items that occupy more than one screen. If all items appear in one screen, the scroll bar is empty.







## Inbox Icons

The following icons indicate the status of messages in the inbox.

Inbox Icon	Description
	<b>Unread (New) Message</b> Indicates that you have not read the message yet.
	<b>Read (Old) Message</b> Indicates that you have read the message.
	<b>Sender Information in Message View</b> Indicates sender information (name or number).
	<b>Time and Date Stamp in Message View</b> Indicates the time and date of message arrival.

## Contact Icons

In the contact list display, the following icons may appear next to the contact numbers to indicate the type of stored number.

Contact Icon	Description
	Private ID Number
	Mobile Phone Number
	Home Phone Number
	Work Phone Number
	PABX Number
	Other Phone Number
	<b>Pickers</b> Indicate more than one number is stored with the contact.

## Text Entry Icons

### Selecting the Text Entry Mode

Text entry modes make it easy for you to enter names, numbers, and messages.

In the text entry screen, select  > **Entry Mode**, and then select one of the following modes:

- **Primary**—for entering alphanumeric characters
- **Numeric**—for entering numbers only
- **Symbol**—for entering symbols only
- **Secondary**—for entering alphanumeric characters. (This mode is optional and you have to add it to the list.)

In the text entry screen, you can also press  repeatedly to change to Primary, Numeric, Symbol, or Secondary (if you have set it up).

### Adding Secondary to the List of Text Entry Modes

Secondary is convenient when you use one language, and sometimes wish to switch to another one.

This mode appears in the list only if you set it up first via

**MENU** > Entry Setup.

**None** is the default programming from factory and indicates no secondary entry mode is selected.

**Selecting the Text Entry Method and Language**

There are two text entry methods:

- TAP—Enter letters, numbers and symbols by pressing an Alphanumeric key one or more times.
- iTAP—Let the terminal predict each word as you press an Alphanumeric key.

You can use these methods in the languages programmed in the terminal.

In the text entry screen, select **MENU** > **Entry Setup**, and then change to one of the methods and its related language (for example: TAP English).

**Text Capitalisation**

Press **⓪+↕**.

**Icons**

In the text entry screen, icons tell you which text entry mode and method you are using. A character counter icon indicates the number of entered characters.

Primary Icons	Secondary Icons	Description
abc 1	abc 2	TAP—no capitals
Abc 1↑	Abc 2↑	TAP—capitalise next letter only
ABC 1↑	ABC 2↑	TAP—all capitals
abc	abc	iTAP—no capitals
Abc	Abc	iTAP—capitalise next letter only
ABC	ABC	iTAP—all capitals

Numeric Icon	Description
123	Enter numbers.
123	Enter numbers in iTAP method.

Symbolic Icon	Description
@	Enter punctuation and symbols.

# Getting Started

---

## Battery

### Installing the Battery

1. Remove the battery from its protective clear plastic case.
2. Insert the battery top into the compartment as illustrated.
3. Carefully press the battery bottom downward until it clicks into place..

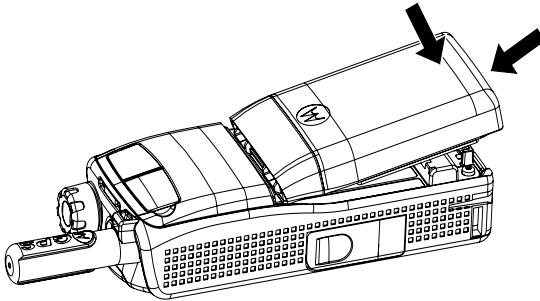

### Replacing the Battery

To remove the battery:

1. Push the latch on the bottom.
2. Lift the bottom of the battery out.
3. Replace the battery.

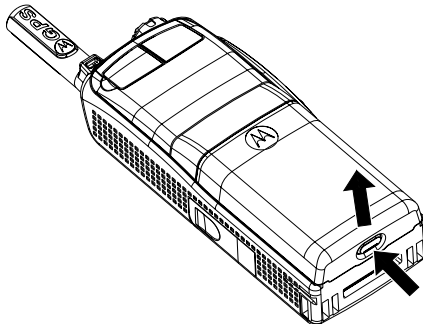

## Charging the Battery

Motorola approved chargers provide optimum performance. Other chargers may not fully charge your Motorola Lithium-Ion battery or may reduce the life of the battery.

The MTP850 can be either **On** or **Off** during charging.

1. Insert the connector on the charger into the socket at the base of the MTP850. Select the required plug adapter (UK or European type) and connect to the charger. Then plug the charger into a suitable mains socket.
2. The MTP850 displays the **Charger Connected** message only if the MTP850 is **On** when connecting the charger. If the MTP850 is **Off**, the display shows an icon of the battery in charging.

The Battery icon shows the charging status (see below).



Empty



Full



Empty



Full

*Battery Capacity*

*Battery Charge Progress*

## Battery Capacity Information

Information	Description
Green icon	Full (50% - 100% capacity)
Yellow icon	Middle (20% - 50% capacity)
Red icon	Low (10% - 20% capacity)
Empty icon	Very low (5% - 10% capacity)
<b>Low battery</b> message	Less than 5% capacity

## Attaching the Antenna



Turn the MTP850 Off before installing or removing the antenna.

Insert the bottom of the antenna into the screw-in base on the top of the MTP850. Turn clockwise until snug. **Do not force.**

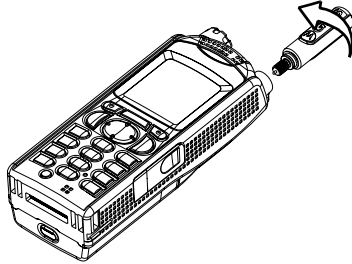

## Powering On/Off (On-Off/End/Home Key)

To power **On**, press and hold . Your MTP850 performs a self-check and registration routine. After successful registration, the MTP850 is in service.

To power **Off**, press and hold . You will hear a beep and the **Powering Off** message is displayed.

## Powering On (Emergency Button)

Press and hold the Emergency button to power **On**. The MTP850 will power **On** in Emergency Mode or in standard mode (as programmed).

## Powering On with Transmit Inhibit (TXI) Active

Transmit Inhibit is a feature allowing you to switch off transmission before entering a Radio-Frequency (RF) sensitive area. To activate this feature, press  and select **More...> Networks > TXI Mode > Activate**.



*Pressing the Emergency button, even if Transmit Inhibit is activated, causes the MTP850 to transmit immediately. The MTP850 must **NOT** be within the RF sensitive area when entering Emergency Mode.*



The TXI Mode remains active at power **On**. You will be asked whether to leave the TXI Mode **On** or not.



*Ensure you have left the RF sensitive area before deactivating Transmit Inhibit.*

Press the **Yes** soft key to deactivate the TXI Mode. If the MTP850 was previously used in Trunked Mode, it will register to the network. If the MTP850 was previously used in Direct Mode, it will remain in Direct Mode.

Press **No** in Trunked Mode and the MTP850 powers down; press **No** in Direct Mode and you remain in Direct Mode with TXI selected.





## Unlocking the MTP850

Your MTP850 may be locked at power up.



To unlock the MTP850 after powering on, enter the code at the prompt. The MTP850 enters the default Home display.

The unlock code is originally set to 0000. Your Service Provider may change this number before you receive your terminal.

## Locking/Unlocking the Keypad

Press   to lock the keypad. Press again   to unlock.



*When there is an incoming call and the keypad is locked, you can still use the **PTT**, Rotary knob, , , and .*





*The Emergency button is not locked. Pressing the Emergency button unlocks the keypad.*

# Selecting TMO or DMO Operation

---

## Entering TMO or DMO

Enter TMO or DMO in one of the following ways:

- From the Home display press **Optns** and select **Direct Mode** if the MTP850 is in TMO.
- From the Home display press **Optns** and select **Trunked Mode** if the MTP850 is in DMO.
- Press  and select **More...> Networks > Trunked Mode** if the MTP850 is in DMO.
- Press  and select **More...> Networks > Direct Mode** if the MTP850 is in TMO.
- Press the TMO/DMO one-touch button (if programmed by your Service Provider).

You can make and receive the following types of calls when the MTP850 operates in Trunked Mode:

- Group Calls
- Private Calls
- Phone Calls
- PABX Calls — local (office) extension calls
- Emergency Calls.

You can make and receive Group Calls when the MTP850 operates in Direct Mode. This includes Emergency Group Calls.

The MTP850 returns to the Home display when there is no activity for a few seconds.



*Your terminal can alert you of an incoming call. Select the alert settings in the Vibrate menu and Tones menu items.*

## Group Calls

A Group Call is a communication between you and others in a group. A group is a pre-defined set of subscribers enabled to participate in and/or invoke a Group Call.

Groups are organised in **folders**. Each folder may contain several groups.

### “My Groups” Folder

You can organise your favourite groups into one folder called “My Groups”.

### Selecting the “My Groups” Folder

From the Home display, press  to quickly access the folder.

### Adding a Group (TMO/DMO) to the “My Groups” Folder

1. Press  and select **More > Group Setup > My Groups > Edit List > [New Group]**.
2. Select a group by alphabetic search (“**TMO/DMO by abc**”). Enter the first character of the group name. Or select a group by folder search (“**TMO/DMO by Folder**”). Select the folder and select the group. The group is added to the “My Groups” folder.

### Selecting a Group



*When you navigate in the “My Groups” folder and select a DMO group, your terminal will switch between TMO and DMO (and vice-versa).*

### Using the Rotary Knob

(If programmed)

From the Home display, press shortly on the Rotary knob and rotate until the requested group appears.

Group selection occurs:

- After a time-out,
- Or, by pressing **Select** (if configured by your Service Provider).

### Using the Navigation Key

From the Home display, scroll left or right until the requested group

appears. Then press **Select** to confirm selection.

## Using Alphabetic Search

From the Home display, press **Optns.** Select a group by alphabetic search (“**TG by abc**”). Enter the first character of the group name. Select the group.

## Using Folder Search

From the Home display, press **Optns.** Select a group by folder search (“**TG by Folder**”). Select the folder and select the group.

## Selecting a Folder

From the Home display, press **Optns.** Select **Folder**, and select the desired folder. The display shows the last selected group in that folder.

## TMO Group Calls

In TMO the MTP850 is used with your Service Provider’s infrastructure.

### Making a TMO Group Call

1. From the Home display and if this is the required group, press and hold the **PTT**.
2. Wait for the talk permit tone and then speak into the microphone. Release the **PTT** button to listen.

When you start a call, all members of the selected group who have their units turned on, will receive the Group Call.



*If you are in an on-going Group Call and wish to make a new call, press  to ignore the current call. Start the new call.*



*The **No Group** message is displayed when you are out of the normal coverage area of your selected group. You must then select a new group that is valid for your working location.*

### Receiving a TMO Group Call

Unless it is engaged in a call, your MTP850 will receive the Group Call. To answer the call, press and hold **PTT**.

Your MTP850 shows the group name and the caller’s private number or alias if previously stored in your contact list.

## Receiving a TMO Broadcast Call

The Broadcast Call (also called Site Wide Call) is a high-priority Group Call from the console operator (or dispatcher) to all users. The MTP850s are configured to monitor a Broadcast Call, but users cannot talk back.

The Broadcast Call pre-empts an on-going Group Call that has the same (or lower) call priority.

## DMO Group Calls

In DMO the MTP850 can be used without your Service Provider's infrastructure.

DMO allows communication with other terminals also operating in DMO, which are on the same frequency and group as your MTP850.



*In DMO you can only place Group Calls and Emergency Group Calls.*

When you start a call, the members of the selected group who have their units turned on will receive the Group Call.

In DMO the MTP850 can communicate with the trunking system (and vice-versa) if the Gateway option is enabled in the MTP850.

## Making a DMO Group Call

1. Enter **Direct Mode** by pressing **Optns** and selecting **Direct Mode**.
2. Make sure that you have selected the required group. Press and hold the **PTT** button.
3. Wait for the talk permit tone and then speak into the microphone. Release the **PTT** button to listen.

## Receiving a DMO Group Call

You can receive a DMO Group Call only when your MTP850 is in DMO.

Unless it is engaged in a call, your MTP850 will receive the Group Call. To answer the call, press and hold **PTT**.

Your MTP850 shows the group name and the caller's private number or alias if previously stored in your contact list.

## Exiting DMO

To exit DMO, press **Optns** and select **Trunked Mode**.



# Private, Phone, and PABX Calls

---



If you are in an on-going Group Call wish to make a new call, press  to ignore the current call. Dial the number.

## Creating a Contact



1. From the Home display, press **Contcs**. Select [New Contact].
2. Enter name. Press **Ok** to confirm.
3. Press  /  and select the type of stored number (such as Private).
4. Enter number (#). Press **Ok**.
5. Continue to enter other types and numbers, as you may keep several numbers (Private, Mobile, Home, Work, PABX, Other) for the same person under the same contact name.
6. When finished, press **Done**. Press **Back** to return to Home display.



## How to Dial

### Dialing a Number

1. From the Home display dial a number.
2. Press **CType** repeatedly to select the call type (Private, Phone, or PABX).
3. Press **PTT** or  depending on the call type.

### Dialing via the Contact List

You can also use the contact list to select a number you previously stored. Press **Contcs** and search the stored number by scrolling ( or ) or by entering the first character of the contact name.

If the contact has more than one number, use  /  to select the number.

## Private Call

A Private Call, also called Point-to-Point or individual call, is a call between two individuals. No other terminal can hear the conversation. This call can be a full-duplex call (if the system allows) instead of the standard half-duplex call.

### Making a Private Call

1. From the Home display dial a number.
2. If Private is not the first type of call presented, press **CType** to select the Private Call type.
3. For a *half-duplex* call, press and release the **PTT** button. You will hear a ringing tone. Wait for the called person to answer your call. Press and hold **PTT**. Wait for the talk permit tone (if configured) before talking, and release the **PTT** when listening.



For a *full-duplex* call, press and release . You will hear a ringing tone. Wait for the called person to answer your call.

4. To end the call, press . If the called person ends the call, the **Call Ended** message is displayed.



*While Transmit Inhibit is activated, an incoming Private Call is indicated, but you cannot answer the call.*

### Receiving a Private Call

1. The MTP850 switches to the incoming Private Call. The display shows the caller's identity.
2. To answer an incoming *half-duplex* call, press **PTT**. To answer an incoming *full-duplex* call (indicated by **Spkror Erpce** soft keys), press .
3. To end the call, press .



*Your terminal can alert you of an incoming call. Select the alert settings in the Vibrate menu and Tones menu items*

## Phone and PABX Calls

The **Phone Call** allows you to call a landline telephone number or a cellular mobile phone number.

The **Private Automatic Branch Exchange (PABX) Call** allows you to call local (office) extension numbers. This type of call needs to be activated by your Service Provider

In this publication we use “phone number” when referring to these numbers.



*While Transmit Inhibit is activated, an incoming Phone or PABX Call is indicated, but you cannot answer the call.*

## Making a Phone or PABX Call

1. From the Home display dial a number.
2. If Phone or PABX are not the first type of call presented, press **CType** repeatedly to select the Phone or PABX call type.
3. Proceed as for making and receiving full-duplex Private Calls.



# Emergency Mode

---

You can send and receive **Emergency Group** Calls in **Trunked Mode** or in **Direct Mode**. If your terminal is configured to operate through a gateway, Emergency calls can be placed through the gateway.

You can initiate an Emergency Group Call to and receive it from

- the selected group (TMO and DMO) (if tactical emergency) or
- a pre-defined group (if non-tactical emergency).

Contact your Service Provider to know which is the selected mode.

Your Service Provider will configure the Emergency Alarm and Hot Microphone features.

Emergency calls will be allocated emergency priority in the system.

## Entering or Exiting Emergency Mode

To enter Emergency Mode, press **and hold** the Emergency button at the top of the MTP850.



*The required time you need to press the Emergency button is set to default to 0.5 seconds. The time can be configured by your Service Provider.*

To exit Emergency Mode, press and hold **Exit**. Your terminal will switch to the Home display.

## Sending an Emergency Alarm (TMO Only)

Your MTP850 will send an Emergency Alarm to the dispatcher (if configured by your Service Provider):

- Automatically, upon entering Emergency Mode.
- If you press the Emergency button again while the MTP850 is in Emergency Mode.

After sending the alarm, the display will show one of the following delivery reports:

- **Alarm Sent**
- **Alarm Failed**

In both cases, the display returns within a few seconds to the main screen of the Emergency Mode.



*The Emergency Alarm is a special status message sent to the dispatcher monitoring the selected group. This can be used in dispatch systems to highlight emergency calls.*



Some systems do not support the Emergency Alarm feature when the user is in a “Local Area Service” area.



Pressing the Emergency button, even if Transmit Inhibit is activated, causes the MTP850 to transmit immediately. The MTP850 must NOT be within the RF sensitive area when entering Emergency Mode.

## Hot Microphone Feature

If the Hot Microphone feature was programmed into your MTP850 by your Service Provider, you can make an Emergency Group Call and talk to the dispatcher (and members of your group) without the need to press and hold the **PTT**.

The microphone will stay open for a time period (programmed by your Service Provider). The microphone will stay open until:

- the Hot microphone time period expires
- you press **PTT** during the Hot Microphone period
- you press the **End** key

At the end of the Hot Microphone the **Hot Mic Ended** message will be displayed and the MTP850 returns to the Emergency Mode. The Hot Microphone feature is disabled and PTT operation returns to normal.

If required you can resume Hot Microphone by pressing the Emergency button again.

## Making an Emergency Group Call

To initiate or answer a call while in Emergency Mode:

- Press and hold **PTT**.
- Wait for the talk permit tone (if configured) and talk.
- Release **PTT** to listen.

# Messages

---

## Sending a Status Message

Select the desired group, then press **MENU** and select **Messages** > **Send Status**. Select status and press **OK** or **PTT**.

## Sending a New Message

Press **MENU** and select **Messages** > **New Message**. Write your message. Select **Send**, or press **OK** or **PTT**. Select your mail recipient or enter number. Select **Send**, or press **OK** or **PTT** to send the new message.

## Sending a User-defined Message

Press **MENU** and select **Messages** > **Templates**. Scroll and choose your required template. Select **Send**, or press **OK** or **PTT**. Select your mail recipient or enter number. Select **Send**, or press **OK** or **PTT** to send the message.

## Sending a Predefined Message

Press **MENU** and select **Messages** > **Predefined**. Scroll and choose your required template. Press **MENU** and select **Edit** to edit the message. Type required information. Select **Send**, or press **OK** or **PTT** to send the message.

## Handling New Incoming Text Messages

Your MTP850 will alert you of an incoming message and enter the inbox automatically, if there is no on-going activity in the terminal. Scroll to the message and select **Read** soft key. To read a long message, press **More** to read the next page and **Back** to return to the previous page.

Then select **Reply**. Or Press **MENU** and select to store/delete/delete all/forward.

## Handling Unread (New) Messages

Press  and select **Messages > Inbox**. Scroll to the message and select **Read** soft key. To read a long message, press **More** to read the next page and **Back** to return to the previous page.

Press  and select to store/delete/delete all/reply/forward.

# Tips & Tricks

---

## Modeless Operation

No need to select a mode (Group / Private / Phone) before initiating a call. Just dial a number and press **CType** (call type) soft key to decide what call it is (then press **PTT** or ).

## Home Key

Not sure where you are? Want to get back to Home display?

Press .

## Backlight Control

You can either disable backlight (covered operation) or have it automatically turned on, by any key press.



You can also press the upper Side key - just to turn On/Off the backlight (if configured by your Service Provider).

## One Touch

Your Service Provider can program the two Side keys and the Numeric keys (0-9) to many functions such as Flip Display, TMO to DMO switching and vice-versa, etc.

Press and hold the keys to see to which function they are programmed.

## Menu Shortcuts

- You can easily access any menu item, by pressing  and a Numeric key. (No delay between  and the key!)
- You can ask your Service Provider to program menu shortcuts.
- You may also define a new shortcut: enter the menu item, press and hold , and follow the instructions in the display.

## High/Low Audio Control

You can control audio routing (speaker/earpiece) for any Private or Group Call via the dedicated Speaker Control key.

However, you can define via the menu to have all Group Calls in high audio ( > **Setup** > **Group Audio**).

## Unified Contact List

You can keep several numbers (Private, Mobile, Home, Work, PABX, Other) for the same person under the same contact name. You can create up to 1000 contacts, and have a total of 1000 private numbers and 1000 phone numbers.

## Text Size

You can see the text on the display in two sizes: **Standard** or **Zoomed** ( > **Setup > Display > Text Size**).

## Group Capacity

Your Service provider can program up to 2048 groups for Trunked Mode, and up to 1024 groups for Direct Mode.

## Flexible Folders

You can ask your Service Provider to define how many groups will be in each folder (up to 256 folders).

## “My Groups” Folder

You can select any group (TMO or DMO) and add it to your personal folder.

In the Home display, press  to quickly access your “My Groups” folder.

## Options (in the Home Display)

You can easily change folder, select groups, switch between TMO and DMO (and vice-versa), and other functions via the Home display Options.

## Easy Navigation while in Menu

When scrolling up/down menu items, try also right/left scrolling. (This will select the item or return to previous level.)

## Flipped Display On/Off



When this feature is activated, the contents of the display are flipped upside down. This feature is particularly useful if you have to wear the MTP850 on the shoulder, belt, or lapel and at the same time wish to read the display upside down.

To activate/deactivate, press  and select **Setup > Display > Flip Display**. Or press and hold the pre-programmed one-touch button.

**Dialed Call List - Quick Access**

From the Home display press  to access the list of the last dialed calls.

**Automatic Scrolling via Navigation Key**

In a list press and hold  or  for automatic scrolling.

**Recent Calls Menu - Quick Access**

From the Home display press .







**MOTOROLA**

## MTP850

### Quick Reference Guide

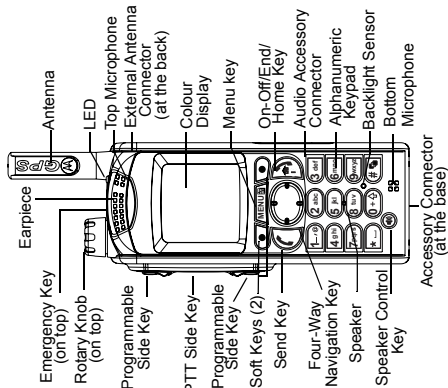

### Turning the MTP850 On/Off

To power the MTP850 on/off, press and hold **PTT**.

### Using the MTP850 Menu System

- To enter the menu, press **MENU**.
- To scroll through the menu, press **Left Arrow** or **Right Arrow**.
- To select a menu item, press **Select** soft key or **Left Arrow**.
- To return to previous level, press **Back** soft key or **Left Arrow**.
- To exit the menu items, press **Exit** soft key or **Left Arrow**.

### Selecting Trunked/Direct Mode Operation

- Your terminal may be configured with a One-touch button to switch between TMO/DMO. Contact your Service Provider for more information.
- From the Home display press **Options**, select **Trunked Mode** or **Direct Mode**.

### Making a TMO Group Call

From the Home display navigate to the desired group. Press **Select** soft key (if configured). Press and hold **PTT**. Wait for the talk permit tone (if configured) and talk. Release **PTT** to listen.

### Making a DMO Group Call

Enter DMO. Navigate to the desired group. Press **Select** soft key (if

configured). Press and hold **PTT**. Wait for the talk permit tone (if configured) and talk. Release **PTT** to listen.

### Making a TMO Emergency Group Call

Enter TMO. Press and hold the Emergency button. Emergency alarm is sent automatically. Press and hold **PTT**. Wait for the talk permit tone (if configured) and talk. Release **PTT** to listen. If using "Hot Mic" feature, wait for the **Emergency Mic On** message to appear on the display and talk without pressing **PTT**.

To exit Emergency Mode, press and hold **Exit** soft key.

### Making a DMO Emergency Group Call

Enter DMO. Press and hold the Emergency button. Press and hold **PTT**. Wait for the talk permit tone (if configured) and talk. Release **PTT** to listen. To exit Emergency Mode press and hold **Exit** soft key.

### Making a Phone/PABX Call

From the Home display dial a number. Press **CType** to select the call type. Press **Call** to speak and press **End** to terminate call.

### Making a Half-duplex Private Call

From the Home display dial a number. Press **CType** to select the call type. Press and release **PTT**. Ringing sounds. Called party answers. Wait for the called party to finish speaking. Press and hold **PTT**. Wait for the talk permit tone (if configured) and talk. Release **PTT** to listen. Press **▶** to terminate call.

### Making a Full-duplex Private Call

From the Home display dial a number. Press **CType** to select the call type. Press and release **◀**. Ringing sounds. Called party answers. Press **▶** to terminate call.

### Answering a Call

Your MTP850 switches to the incoming call and alerts you of the incoming call. To answer the call, press **◀** for Phone/PABX/Full-duplex Private calls or press **PTT** for all other calls.

### Sending a Status Message

Select the desired group, then press **◀** and select **Messages > Send Status**. Select status and press **◀** or **PTT**.

### Sending a New Message

Press **◀** and select **Messages > New Message**. Write your message. Select **Send**, or press **◀** or **PTT**. Select

your mail recipient or enter number. Select **Send**, or press **◀** or **PTT** to send the new message.

### Tips & Tricks

Home Key

Not sure where you are? Want to get back to Home display? Press **▶**.

### Backlight Control

You can either disable backlight (covered operation) or have it automatically turned on, by any key press.

You can also press the upper Side key - just to turn On/Off the backlight (if configured).

### Menu Shortcuts

You can easily access any menu item, by pressing **◀** and a numeric key. (No delay between **◀** and the key!) You can ask your Service Provider to program menu shortcuts.

You may also define a new shortcut: enter the menu item, press and hold **◀**, and follow the instructions in the display.

### High/Low Audio Control

You can control audio routing (speaker / earpiece) for any Private or Group Call via the dedicated speaker control key.

However, you can define via the menu to have all Group calls in high audio (**◀**) > **Setup > Group Audio**).

### Unified Contact List

You can keep several numbers (Private, Mobile, Home, Work, PABX, Other) for the same person under the same contact name.

### Text Size

You can see the text on the display in two sizes: **Normal** or **Zoomed** (**◀**) > **Setup > Display > Text Size**).

### “My Groups” Folder

You can select any group (TMO or DMO) and add it to your personal folder. In the Home display, press **▶** to quickly access your “My Groups” folder.