



The low cost M-Series utilizes the hydraulic magnetic principle which provides accurate and reliable circuit protection even when exposed to extremely hot and/or cold application environments.

Available in a choice of rocker actuator styles and colors, push button, push-pull, paddle, and baton style handle actuators, the Visi-Rocker® two-color actuators as well as non-illuminated or illuminated rocker versions with LED or neon bulbs. The exclusive Rockerguard® bezel helps prevent inadvertent actuation. "Wiping" contact design insures long term reliability. Various styling options allow design flexibility.

Typical applications include power supplies, medical equipment, and telecommunications equipment. In addition, these breakers meet CSA Standard 22.2 No. 100 for the Generator & Welder markets.

Agency Certifications

UL Recognized

UL Standard 1077



Component Recognition Program as Protectors, Supplementary (Guide CCN/QVNU2, File E75596)

CSA Accepted



Component Supplementary Protector under Class 3215 30, File 047848 0 000
CSA Standard C22.2 No. 235

UL Listed

UL Standard 489A



Communications Equipment (Guide CCN/DITT, File E189195)

VDE Certified



EN60934, VDE 0642 under File 10537

TUV Certified



EN60934, under License No. R9671109

Electrical

Table A: Lists UL Recognized and CSA Accepted configurations & performance capabilities as a Component Supplementary Protector.

M-SERIES TABLE A: COMPONENT SUPPLEMENTARY PROTECTORS										
CIRCUIT CONFIGURATION	VOLTAGE			CURRENT RATING		POLES BREAKING	SHORT CIRCUIT CAPACITY (AMPS)		APPLICATION CODES	
	MAX. RATING	FREQUENCY	PHASE	FULL LOAD AMPS	GENERAL PURPOSE AMPS		U / CSA		UL	CSA
							WITH BACKUP FUSE	WITHOUT BACKUP FUSE		
SERIES	32	DC	--	0.02 - 15	--	1	--	1000	TC1.2, OL1, U1	TC1.2, OL1, U1
				--	15.1 - 25	1	--	1000	TC1.2, OL0, U1	TC1.2, OL0, U1
	50 ²	DC	--	0.02 - 7.5	--	1	--	1000	TC1.2, OL0, U1	TC1.2, OL0, U1
				0.02 - 15	--	2	--	1000	TC1.2, OL1, U1	TC1.2, OL1, U1
	65	DC	--	0.02 - 15	--	1	--	1000	TC1.2, OL1, U1	TC1.2, OL1, U1
				--	15.1 - 25	2	--	1000	TC1.2, OL0, U1	TC1.2, OL0, U1
	65 ^{1,2}	DC	--	0.02 - 15	--	1	--	1000	TC1.2, OL1, U1	TC1.2, OL1, U1
				--	15.1 - 30	1	--	1000	TC1.2, OL0, U1	TC1.2, OL0, U1
	65	DC	--	0.02 - 15	--	2	5000 ³	--	TC1.2, OL1, C1	TC1.2, OL1, C1
				--	15.1 - 25	2	5000 ³	--	TC1.2, OL0, C1	TC1.2, OL0, C1
	80 ¹	DC	--	0.02 - 15	--	1	--	600	TC1.2, OL1, U1	TC1.2, OL1, U1
				--	15.1 - 30	1	--	600	TC1.2, OL0, U1	TC1.2, OL0, U1
	125	50 / 60	1	0.02 - 15	--	1	--	1000	TC1.2, OL1, U1	TC1.2, OL1, U1
				--	15.1 - 30	1	--	1000	TC1.2, OL0, U1	TC1.2, OL0, U1
				1 - 30	--	1	--	360	TC1,OL1,U2	TC3, OL1, U3
	250	50 / 60	1	0.02 - 12	--	1	--	1000	TC1.2, OL1, U1	TC1.2, OL1, U1
	250 ²	50 / 60	1	--	12.1 - 18	1	1000 ⁴	--	TC1.2, OL0, C1	TC1.2, OL0, C1
				0.02 - 15	--	2	--	1000	TC1.2, OL1, U1	TC1.2, OL1, U1
250	50 / 60	1	--	15.1 - 30	2	--	1000	TC1.2, OL0, U1	TC1.2, OL0, U1	
			1 - 30	--	1	--	360	TC1,OL1,U2	TC3, OL1, U3	

NOTES FOR TABLE A

- 1 Polarity Sensitive
- 2 Available only with Special Catalog Number. Consult Factory.
- 3 Requires Branch Circuit Backup with a UL Listed type K-5 or RK-5 fuse rated 30 Amps maximum
- 4 Requires Branch Circuit Backup with a UL Listed type K-5 or RK-5 fuse rated 60 Amps maximum

Electrical

Table B: Lists UL Recognized, CSA Accepted and TUV and VDE Certified configurations and performance capabilities as a Component Supplementary Protector.

M-SERIES TABLE B: COMPONENT SUPPLEMENTARY PROTECTORS												
CIRCUIT CONFIGURATION	VOLTAGE			CURRENT RATING		POLES BREAKING	SHORT CIRCUIT CAPACITY (AMPS)				APPLICATION CODES	
	MAX. RATING	FREQUENCY	PHASE	FULL LOAD AMPS	GENERAL PURPOSE AMPS		U L / CSA		VDE / TUV		UL	CSA
							WITH BACKUP FUSE	WITHOUT BACKUP FUSE	WITH BACKUP FUSE ⁵	WITHOUT BACKUP FUSE		
SERIES	32	DC	—	0.02 - 15	—	1	—	1000	3000	500	TC1,2, OL1, U1	TC1,2, OL1, U1
				15.1 - 20 ⁴	—	1	—	1000	3000	500	TC1,2, OL0, U1	TC1,2, OL0, U1
	50 ²	DC	—	0.02 - 7.5	—	1	—	1000	3000	500	TC1,2, OL0, U1	TC1,2, OL0, U1
				0.02 - 15	—	2	—	1000	3000	500	TC1,2, OL1, U1	TC1,2, OL1, U1
	65 ³	DC	—	—	15.1 - 20 ⁴	2	—	1000	3000	500	TC1,2, OL0, U1	TC1,2, OL0, U1
				0.02 - 15	—	2	5000	—	3000	500	TC1,2, OL1, C1	TC1,2, OL1, C1
	65	DC	—	0.02 - 15	—	2	5000	—	3000	500	TC1,2, OL0, C1	TC1,2, OL0, C1
				15.1 - 20 ⁴	—	2	5000	—	3000	500	TC1,2, OL0, C1	TC1,2, OL0, C1
	80 ¹	DC	—	0.02 - 15	—	1	—	600 ⁴	—	600	TC1,2, OL1, U1	TC1,2, OL1, U1
				—	15.1 - 25 ⁴	1	—	600 ⁴	—	600	TC1,2, OL0, U1	TC1,2, OL0, U1
	125	50 / 60	1	0.02 - 15	—	1	—	1000	3000	500	TC1,2, OL1, U1	TC1,2, OL1, U1
				1 - 15	—	1 ⁵	—	360	3000	500	TC1,OL1,U2	TC3, OL1, U3
	250	50 / 60	1	0.02 - 12	—	1	—	1000	3000	500	TC1,2, OL1, U1	TC1,2, OL1, U1
				0.02 - 20	—	2	—	1000	3000	500	TC1,2, OL1, U1	TC1,2, OL1, U1
1 - 12				—	1 ⁵	—	360	3000	500	TC1,OL1,U2	TC3, OL1, U3	

NOTES FOR TABLE B

- 1 Polarity Sensitive
- 2 Available only with Special Catalog Number. Consult Factory.
- 3 Requires Branch Circuit Backup with a UL Listed type K-5 or RK-5 fuse rated 30 Amps maximum
- 4 TUV only, not VDE
- 5 Requires backup protection with a thermal magnetic circuit breaker rated 32 amps and having a Type C trip characteristic per EN60898/DIN VDE 0641 (C32A) for ratings greater than 15 amps, and a thermal magnetic circuit breaker rated 16 amps and having a Type C trip characteristic per EN60898/DIN VDE 0641 (C16A) for ratings 15 amps and less.

Table C: Lists UL489A Listed and TUV Certified configurations and performance capabilities for use in Communications Equipment.

M-SERIES TABLE C: UL489A (COMMUNICATIONS EQUIPMENT - POLARITY SENSITIVE)						
CIRCUIT CONFIGURATION	VOLTAGE		CURRENT RATING GENERAL PURPOSE AMPS	POLES BREAKING	INTERRUPTING CAPACITY (AMPS)	
	MAX. RATING	FREQUENCY			WITHOUT BACKUP FUSE	
					UL489A	TUV
SERIES	80	DC	0.02 - 30	1	600	—
	65 ¹	DC	0.02 - 30	1	1000	—
	80	DC	0.10 - 25	1	600	600

NOTES FOR TABLE C

- 1. Available only with Special Catalog Number

Electrical

Maximum Voltage	125/250 VAC 50/60 Hz, 80 VDC (See Rating Tables.)
Current Ratings	Standard current coils: 0.100, 0.250, 0.500, 0.750, 1.00 thru 15.0 in 1 amp increments, 18.0, 20.0, 25.0, 30.0. Other ratings available - see Ordering Scheme.
Auxiliary Switch Rating	SPDT; 7A 250VAC, 7A (Res) 28VDC, 4A (Ind.) 28VDC, 0.25A 80VDC (Res) (silver contacts), 0.1A 125VAC (gold contacts).
Insulation Resistance	Minimum of 100 Megohms at 500 VDC.
Dielectric Strength	UL, CSA 1500V, 50/60 Hz for one minute between all electrically isolated terminals. M-Series Circuit Breakers comply with the 8mm spacing and 3750 V 50/60Hz dielectric requirements from hazardous voltage to operator accessible surfaces, per Publications IEC 380, 435, 950, EN 60950 and VDE 0805.
Resistance, Impedance	Values from Line to Load Terminal - based on Series Trip Circuit Breaker.

RESISTANCE, IMPEDANCE VALUES
from Line to Load Terminals
(Values Based on Series Trip Circuit Breaker)

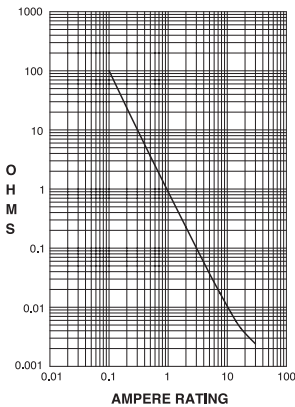

CURRENT (AMPS)	TOLERANCE (%)
0.10 - 20.0	25%
20.1 - 30.0	35%

Pulse Tolerance Curves

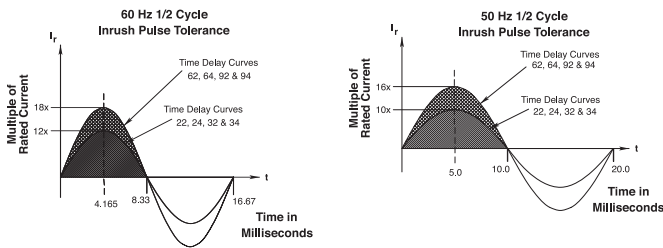

Mechanical

Endurance	10,000 ON-OFF operations @ 6 per minute with rated Current and Voltage.
Trip Free	All M-Series Circuit Breakers will trip on overload, even when actuator is forcibly held in the ON position.
Trip Indication	The actuator moves positively to the OFF position when an overload causes the circuit breaker to trip.
Physical	
Number of Poles	1 or 2
Internal Circuit Configurations	Series with or without Auxiliary Switch. Switch Only with or without Auxiliary Switch.
Weight	Approximately 30 grams/pole (Approximately 1.07 ounces/pole)
Standard Colors	See Ordering Scheme.

Environmental

Designed and tested in accordance with requirements of specification MIL-PRF-55629 & MIL-STD-202 as follows:

Shock	Withstands 100 Gs, 6ms, sawtooth while carrying rated current per Method 213, Cond. I. Instantaneous curves tested at 80% of rated current.
Vibration	Withstands 0.060" excursion from 10-55 Hz, and 10 Gs 55-500 Hz, at rated current per Method 204C, Test Condition A. Instantaneous curves tested at 80% of rated current.
Moisture Resistance	Method 106D, i.e., ten 24-hour cycles @ +25°C to +65°C, 80-98% RH.
Salt Spray	Method 101, Condition A (90-95% RH @ 5% NaCl Solution, 96 hrs).
Thermal Shock	Method 107D, Condition A (Five cycles @ -55°C to +25°C to +85°C to +25°C).
Operating Temperature	-40° C to +85° C
Chemical Resistance	Only the outside surfaces of the case and the handles may be cleaned with detergents or alcohol. Organic (hydrocarbon based) solvents are not recommended because they attack plastics. Caution should be taken when solvents are used to clean and remove flux from terminals. Lubricants should not be introduced into the handle/bushing openings.



1 SERIES
M

2 ACTUATOR 1

Handle
M Paddle N Baton

Push Button
T Push-Pull U Push To Reset

Push Button w/ Snap-In Mounting
V Push-Pull W Push To Reset

3 POLES
1 One 2 Two

4 CIRCUIT 2
without Auxiliary Switch
A Switch Only (No Coil), Maintained Contacts
B Series Trip (Current)

with Auxiliary Switch, Silver Contacts
P³ Switch Only, Maintained Contacts
Q^{3,4} Switch Only, Maintained Contacts
R^{3,13} Switch Only, Maintained Contacts
S³ Series Trip (Current)
T^{3,4} Series Trip (Current)
U^{3,13} Series Trip, Maintained Contacts

with Auxiliary Switch, Gold Contacts
2^{3,4} Switch Only, Maintained Contacts
3^{3,13} Switch Only, Maintained Contacts
4^{3,4} Series Trip (Current)
5^{3,13} Series Trip, Maintained Contacts

Terminal Type:
.060 Dia, Round Solder Turret
.058 Dia, Round Q.C.
.080 Dia x .020 Flat Q.C.
.060 Dia, Round Solder Turret
.058 Dia, Round Q.C.
.080 Dia x .020 Flat Q.C.

5 FREQUENCY & DELAY

03	DC 50/60Hz, Switch Only	32	DC, 50/60Hz Short
10	DC Instantaneous	34	DC, 50/60Hz Medium
12	DC Short	62	50/60Hz Short, Hi-Inrush
14	DC Medium	64	50/60Hz Medium, Hi-Inrush
20	50/60Hz Instantaneous	72	DC, Short, Hi-Inrush
22	50/60Hz Short	74	DC, Medium, Hi-Inrush
24	50/60Hz Medium	92	DC, 50/60Hz Short, Hi-Inrush
30	DC, 50/60Hz Instantaneous	94	DC, 50/60Hz, Medium, Hi-Inrush

Notes:
1 One actuator is located in the center of each multi-pole breaker. Actuator codes V & W limited to single pole breakers only.
2 Switch Only circuits are not available with Push-To-Reset actuators. For Switch Only circuits, select Current Coil Rating from the following chart:

VOLTAGE			FULL LOAD AMP RATING		GENERAL PURPOSE AMP RATING		TUNGSTEN LAMP RATING		POLES BREAKING
MAX. RATING	FREQUENCY	PHASE	MAX. AMPS	CHOOSE CURRENT COIL RATING CODE:	MAX. AMPS	CHOOSE CURRENT COIL RATING CODE:	MAX. AMPS	CHOOSE CURRENT COIL RATING CODE:	
32	DC	-	15	615	25	625	-	-	1
50	DC	-	-	-	7.5	Consult Factory	-	-	1
65	DC	-	15	615	25	625	-	-	2
125	50/60HZ	1	15	615	25	625	15	615	1
250	50/60HZ	1	12	612	-	-	-	-	1
250	50/60HZ	1	15	615	25	625	-	-	2

3 One Auxiliary Switch is supplied per breaker. On two-pole breakers, standard Auxiliary Switch mounting is in pole one. Auxiliary Switch option limited to Series Trip and Switch Only circuits. Not available with back connect screw or push-in stud terminals.
4 Mates with AMP .058" diameter pin receptacles including 60983-1 (gold plated) and 60983-2 (tin plated).
5 Actuator color is only visible in the OFF position on Push-Pull actuators.
6 All units except snap-in mounting have one hex nut installed on bushing for use behind the panel.
7 Other colors available. Consult factory.
8 TUV and VDE Certification above 15 amps is for 2-pole only and is limited to a max. of 25 amps. Screw Terminal or Push-In Stud recommended above 20 amps.
9 30 amp rating not available with delay's 30, 32, 34, 92 or 94.
10 Screw Terminals are VDE certified only with use of ring terminal attached to wire.
11 Terminal code A available with circuit codes A & B only.
12 Printed circuit board available with UL recognized approval only.
13 Auxiliary switch (flat Q.C.) available with UL recognized approvals only.

6 CURRENT RATING (AMPERES)⁶

020	0.020	225	0.250	420	2.000	710	10.500
025	0.025	230	0.300	522	2.250	611	11.000
030	0.030	235	0.350	425	2.500	711	11.500
035	0.035	240	0.400	527	2.750	612	12.000
040	0.040	245	0.450	430	3.000	712	12.500
045	0.045	250	0.500	435	3.500	613	13.000
050	0.050	255	0.550	440	4.000	614	14.000
055	0.055	260	0.600	445	4.500	615	15.000
060	0.060	265	0.650	450	5.000	616	16.000
065	0.065	270	0.700	455	5.500	617	17.000
070	0.070	275	0.750	460	6.000	717	17.500
075	0.075	280	0.800	465	6.500	618	18.000
080	0.080	285	0.850	470	7.000	619	19.000
085	0.085	290	0.900	475	7.500	620	20.000
090	0.090	295	0.950	480	8.000	622	22.000
095	0.095	410	1.000	485	8.500	624	24.000
210	0.100	512	1.250	490	9.000	625	25.000
215	0.150	415	1.500	495	9.500	630 ⁹	30.000
220	0.200	517	1.750	610	10.000		

7 TERMINAL⁸

1	Push-On 0.250 Tab (Q.C.)	A ¹¹	Push-In Stud
2 ¹⁰	Screw 8-32 w/upturned lugs	P ¹²	Printed Circuit Board
3 ¹⁰	Screw 8-32 (Bus Type)		

8 ACTUATOR COLOR⁵

Handle	Push-Button	Actuator Color
1	A	White
2	B	Black
3	C	Red
4	D	Green
5	E	Blue
6	F	Yellow
8	H	Orange

9 FRONT PANEL HARDWARE⁶

	Handle	Push-Button
No outer Panel Hardware	A	1
Knurled Nut		
Bright nickel	B	2
Bright nickel w/ locking ring	C	
Black	D	
Black w/ locking ring	E	
Panel Dress Nut		
Bright nickel	F	
Bright nickel w/ locking ring	G	
Black	H	
Black w/ locking ring	J	

10 LEGEND PLATE / BUTTON MARKING
Handle Actuator Legend Plate (Actuator Styles M & N)
A No Legend Plate
B ON - OFF Vertical
C ON - OFF Horizontal
D I - O Vertical
E I - O Horizontal

Push-Pull Actuator Button Cap (Actuator Styles T & V)
1 No Marking
2 Rated Amps Horizontal
3 Rated Amps Line Side Down
4 Rated Amps Line Side Up

Push-to-Reset Actuator Button (Actuator Styles U & W)
1 No Marking

11 BUSHING COLOR⁷
B Black

12 AGENCY APPROVAL⁸
C UL Recognized & CSA Accepted
D VDE Certified, UL Recognized & CSA Accepted
E TUV Certified, UL Recognized & CSA Accepted



1 SERIES
M

2 ACTUATOR 1

Handle
M Paddle N Baton

Push Button
T Push-Pull U Push To Reset

Push Button w/ Snap-In Mounting
V Push-Pull W Push To Reset

3 POLES
1 One

4 CIRCUIT

without Auxiliary Switch
B Series Trip (Current)

with Auxiliary Switch, Silver Contacts **Terminal Type:**
S 2 Series Trip (Current) .060 Dia, Round Solder Turret
T 2,3 Series Trip (Current) .058 Dia, Round Q.C.
U 3,12 Series Trip, Maintained Contacts .080 Dia x .020 Flat Q.C.

with Auxiliary Switch, Gold Contacts
4,2,3 Series Trip (Current) .058 Dia, Round Q.C.
5 3,12 Series Trip, Maintained Contacts .080 Dia x .020 Flat Q.C.

5 FREQUENCY & DELAY

12 DC Short	72 DC, Short, Hi-Inrush
14 DC Medium	74 DC, Medium, Hi-Inrush

6 CURRENT RATING (AMPERES)

020 0.020	225 0.250	420 2.000	710 10.500
025 0.025	230 0.300	522 2.250	611 11.000
030 0.030	235 0.350	425 2.500	711 11.500
035 0.035	240 0.400	527 2.750	612 12.000
040 0.040	245 0.450	430 3.000	712 12.500
045 0.045	250 0.500	435 3.500	613 13.000
050 0.050	255 0.550	440 4.000	614 14.000
055 0.055	260 0.600	445 4.500	615 15.000
060 0.060	265 0.650	450 5.000	616 16.000
065 0.065	270 0.700	455 5.500	617 17.000
070 0.070	275 0.750	460 6.000	717 17.500
075 0.075	280 0.800	465 6.500	618 18.000
080 0.080	285 0.850	470 7.000	619 19.000
085 0.085	290 0.900	475 7.500	620 20.000
090 0.090	295 0.950	480 8.000	622 22.000
095 0.095	410 1.000	485 8.500	624 24.000
210 0.100	512 1.250	490 9.000	625 25.000
215 0.150	415 1.500	495 9.500	630 30.000
220 0.200	517 1.750	610 10.000	

7 TERMINAL 4

1 Push-On 0.250 Tab (Q.C.)	A ¹⁰ Push-In Stud
2 Screw 8-32 w/upturned lugs	P ¹¹ Printed Circuit Board
3 Screw 8-32 (Bus Type)	

8 ACTUATOR COLOR & LEGEND 5

Gloss Handle	Push-Button	Actuator Color
1	A	White
2	B	Black
3	C	Red
4	D	Green
5	E	Blue
6	F	Yellow
8	H	Orange

9 FRONT PANEL HARDWARE 6

	Handle	Push-Button
No outer Panel Hardware	A	1
Knurled Nut		
bright nickel	B	2
bright nickel w/ locking ring	C	
black	D	
black w/ locking ring	E	
Panel Dress Nut		
bright nickel	F	
bright nickel w/ locking ring	G	
black	H	
black w/ locking ring	J	

10 LEGEND PLATE / BUTTON MARKING

Handle Actuator Legend Plate (Actuator Styles M & N)

- A No Legend Plate
- B ON - OFF Vertical
- C ON - OFF Horizontal
- D I - O Vertical
- E I - O Horizontal

Push-Pull Actuator Button Cap (Actuator Styles T & V)

- 1⁸ No Marking
- 2 Rated Amps Horizontal
- 3 Rated Amps Line Side Down
- 4 Rated Amps Line Side Up

Push-To-Reset Actuator Button Cap (Actuator Styles U & W)

- 1⁸ No Marking

11 BUSHING COLOR 7
B Black

12 AGENCY APPROVAL 9

- J UL489A Listed, TUV Certified
- M UL Recognized, CSA Accepted
- N UL Recognized, TUV Certified
- T UL489A Listed

Notes:

- One actuator is located in the center of each multi-pole breaker. Actuator codes V & W limited to single pole breakers only.
- One Auxiliary Switch is supplied per breaker. On two-pole breakers, standard Auxiliary Switch mounting is in pole one. Auxiliary Switch option limited to Series Trip and Switch Only circuits. Not available with Back Connected Screw or Push-in Stud terminals.
- Mates with AMP .058" diameter pin receptacles including 60983-1 (gold plated) and 60983-3 (tin plated).
- Screw terminals or Push-in Stud recommended above 20 amps.
- Actuator color is only visible in the OFF position on Push-Pull actuators.
- All units have one hex nut installed on bushing for use behind the panel.
- Other colors available. Consult factory.
- Not available with UL489A Listed breakers.
- TUV certified to 25 amps. UL Recognized, CSA Accepted and UL Listed to 30 amps.
- Terminal code A available with circuit codes A & B only.
- Printed circuit board available with UL recognized approval only.
- Auxiliary switch (flat Q.C.) available with UL recognized approvals only.



1 SERIES
M

2 ACTUATOR¹
Non-Illuminated single color
A Angled **B** Flat
Two Color Visi-Rocker
D Indicate ON **E** Indicate OFF
Illuminated single color
F Angled **G** Flat

ROCKER STYLE DESCRIPTION (DUAL LEGENDS SHOWN)				
STYLE	INDICATE "ON" (220VAC)	INDICATE "OFF" (220VAC)	FLAT (200VAC & 0)	ANGLED (200VAC & 0)
VERTICAL				
HORIZONTAL				

3 POLES
1 One

4 CIRCUIT²
without Auxiliary Switch
B Series Trip (Current)
with Auxiliary Switch, Silver Contacts **Terminal Type**
S Series Trip (Current) .060 Dia, Round Solder Turret
T³ Series Trip (Current) .058 Dia, Round Q.C.
U^{3,13} Series Trip, Maintained Contacts .080 Dia x .020 Flat Q.C.
with Auxiliary Switch, Gold Contacts
4³ Series Trip (Current) .058 Dia, Round Q.C.
5^{3,13} Series Trip, Maintained Contacts .080 Dia x .020 Flat Q.C.

5 FREQUENCY & DELAY		14 DC Medium	
10 DC Instantaneous	72 DC, Short, Hi-Inrush		
12 DC Short	74 DC, Medium, Hi-Inrush		

6 CURRENT RATING (AMPERES)					
020	0.020	225	0.250	420	2.000
025	0.025	230	0.300	522	2.250
030	0.030	235	0.350	425	2.500
035	0.035	240	0.400	527	2.750
040	0.040	245	0.450	430	3.000
045	0.045	250	0.500	435	3.500
050	0.050	255	0.550	440	4.000
055	0.055	260	0.600	445	4.500
060	0.060	265	0.650	450	5.000
065	0.065	270	0.700	455	5.500
070	0.070	275	0.750	460	6.000
075	0.075	280	0.800	465	6.500
080	0.080	285	0.850	470	7.000
085	0.085	290	0.900	475	7.500
090	0.090	295	0.950	480	8.000
095	0.095	410	1.000	485	8.500
210	0.100	512	1.250	490	9.000
215	0.150	415	1.500	495	9.500
220	0.200	517	1.750	610	10.000

7 TERMINAL⁹
1 Push-On 0.250 Tab (Q.C.) **A¹¹** Push-In Stud
2 Screw 8-32 w/upturned lugs **P¹²** Printed Circuit Board
3 Screw 8-32 (Bus Type)

8 ILLUMINATION
Non-illuminated Neon⁴
 without resistor, 120VAC/250VAC
LED
 without resistor^{5,7}
 with resistor, 4-8 VDC
 with resistor, 9-16 VDC

A	Neon	Green Glow ⁷	
B		C	
	Red	Green	Amber
D		G	K
E		H	L
F		J	M

9 ACTUATOR & LEGEND COLOR

Solid Color	Actuator	Legend
1	White	Black
2	Black	White
3	Red	White
4	Green	White
5	Blue	White
6	Yellow	Black
7	Gray	Black
8	Orange	Black
Visi-Rocker⁶	Visi & Legend (remainder of rocker same color as bezel)	
1	White	
2	Black	
3	Red	
4	Green	
5	Blue	
6	Yellow	
7	Gray	
8	Orange	
Illuminated⁷	Actuator	Legend
A	Clear	White
B	Red Transparent	White
C	Green Transparent	White
D	Amber Transparent	White
E	Smoke Gray Transparent	White
F	White Translucent	Black

10 LEGEND¹⁰

1	No Legend (Single Color or Illuminated Rocker Options Only)
2	ON - OFF Vertical
3	ON - OFF Horizontal
4	I - O Vertical
5	I - O Horizontal
6	Dual Vertical
7	Dual Horizontal

11 BEZEL COLOR / STYLE⁸

Color	without Rockerguard	with Rockerguard
White	A	1
Black	B	2
Gray	G	7

12 AGENCY APPROVAL⁹

J	UL489A Listed & TUV Certified
M	UL Recognized & CSA Accepted
N	TUV Certified, UL Recognized & CSA Accepted
T	UL489A Listed

- Notes:
- One actuator is located in the center of each multi-pole breaker.
 - One Auxiliary Switch is supplied per breaker. Auxiliary Switch option limited to Series Trip & Switch Only circuits, and is not available in single pole illuminated breakers, or with Back Connected Screw or Push-in Stud terminals.
 - Mates with AMP .058" diameter pin receptacles: 60983-1 (gold plated) & 60983-1 (tin plated).
 - For neon bulb applications at 120VAC @ 47K, 1/4 WATT and for 250VAC applications @ 150K, 1/4 WATT, external resistors must be supplied by customer.
 - For LED (DC or rectified AC) applications, LED is mounted in the center of the rocker actuator with electrical characteristics as follows: 100 millicandela at 20mA; Maximum power dissipation = 75mW at 25°C; Maximum forward current = 25mA; Typical forward voltage = 2.1V at 20mA; Typical reverse current = 100uA at 3V. Customer supplies the proper external resistor limiting current to these values.
 - On Visi-Rocker breakers, Visi portion of rocker cannot be the same color as the bezel. Rocker color for LED's and green neon lamp must be clear, smoke gray, white translucent or match color of LED or neon lamp.
 - Other colors available. Consult factory.
 - TUV Certified to 25 amps. UL Recognized, CSA Accepted and UL489A Listed to 30 amps. Screw Terminals recommended above 20 amps.
 - UL489A Listed must have ON-OFF or Dual legends. TUV Certified approvals must have I - O or Dual legends.
 - Terminal code A available with circuit codes A & B only.
 - Printed circuit board available with UL recognized approval only.
 - Auxiliary switch (flat Q.C.) available with UL recognized approvals only.

SERIES TRIP

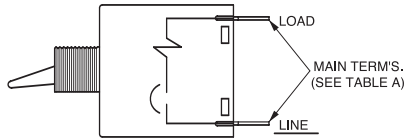

SWITCH ONLY

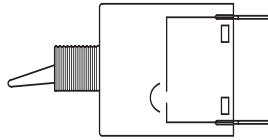

**SERIES TRIP W/
AUXILIARY SWITCH**

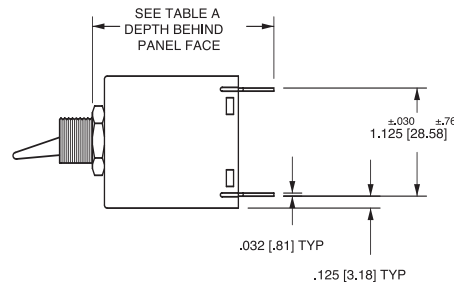
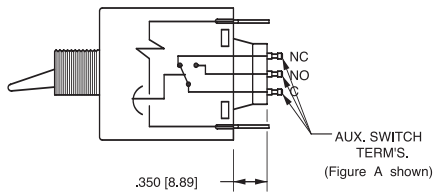

TABLE A		
TERMINAL DESCRIPTION		DEPTH BEHIND PANEL FACE *
MAIN	TAB (Q.C)	1.890 [48.00]
	SCREW (#8-32)	1.930 [49.03]
	PUSH-IN STUD	2.520 [64.00]
AUX. **	DOUBLE SOLDER TURRET TYPE	2.035 [51.69]
	ROUND Q.C TYPE	2.025 [51.44]
	FLAT QUICK-CONNECT	2.129 [54.08]
	FLAT SOLDER LUG	2.012 [51.10]

*DEPTH INCLUDES BEHIND PANEL HEX NUT AS SUPPLIED ON ALL UNITS.

** WHEN CALLED FOR ON MULTI-POLE UNITS, ONLY ONE AUX. SWITCH IS NORMALLY SUPPLIED, MOUNTED AS SHOWN IN FIG. A

MULTI-POLE IDENTIFICATION SCHEME

SOLDER TURRET AND ROUND QC AUX SWITCH TERMINALS

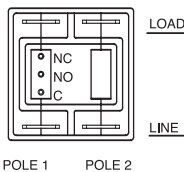

FIG. A

FLAT QC AND SOLDER LUG AUX SWITCH TERMINALS

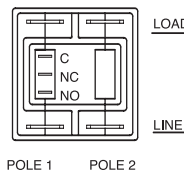
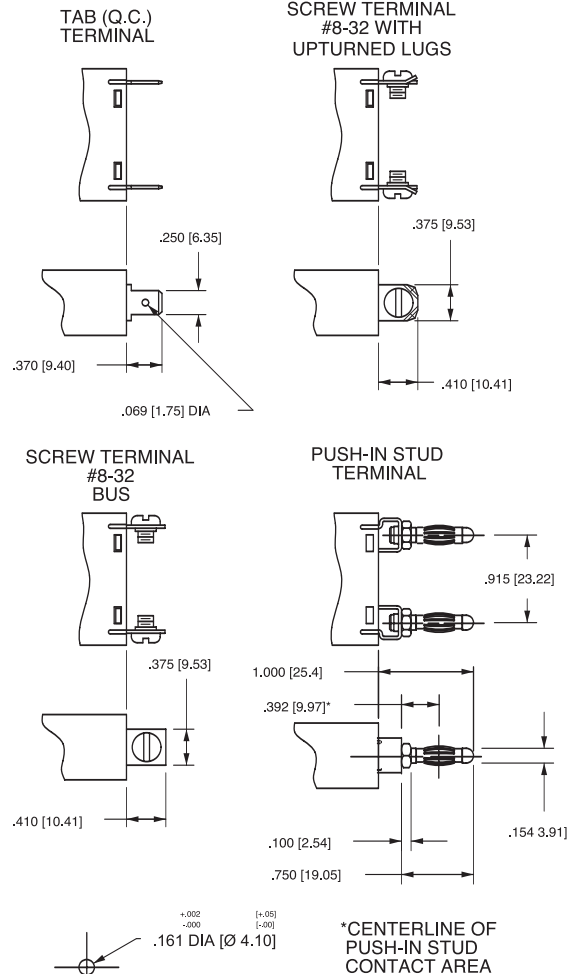
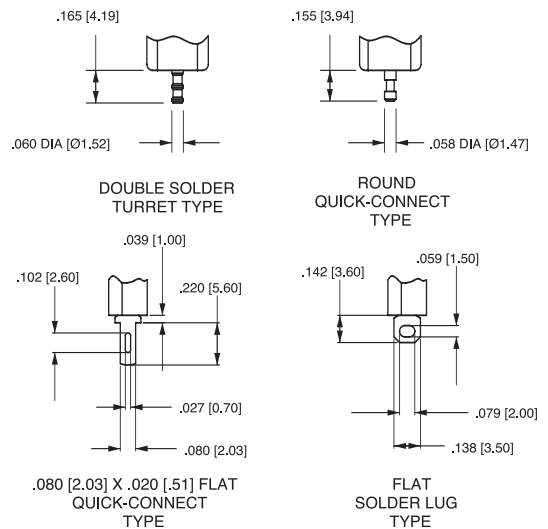

FIG. B

TERMINAL DIMENSIONAL DETAIL



AUXILIARY SWITCH TERMINALS



- Notes:
 1 All dimensions are in inches [millimeters].
 2 Tolerance ±.020 [.51] unless otherwise specified.

PADDLE ACTUATOR STYLE

SINGLE POLE

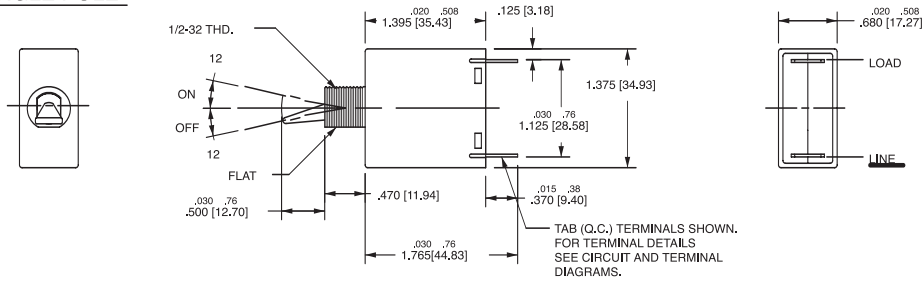

DOUBLE POLE

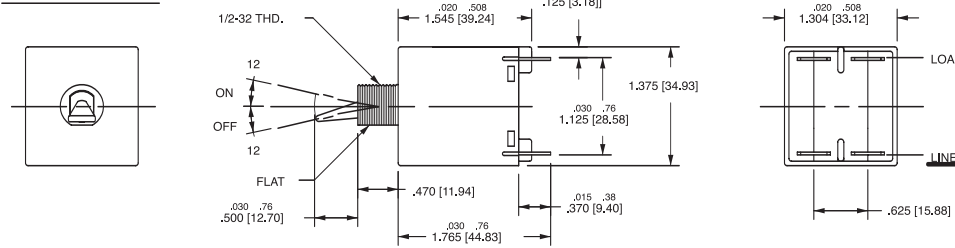

BATON ACTUATOR STYLE

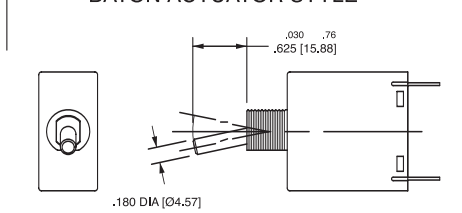

MOUNTING DETAILS

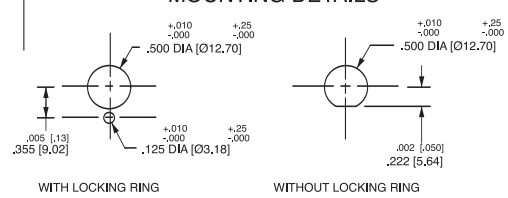

LEGEND PLATES

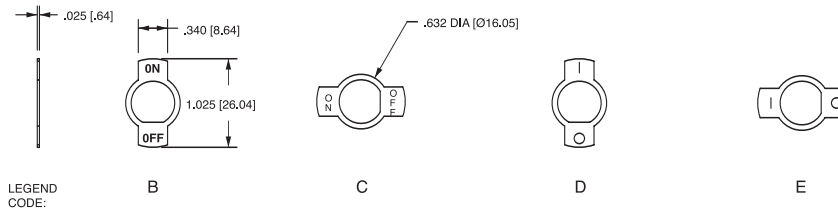

PANEL HARDWARE

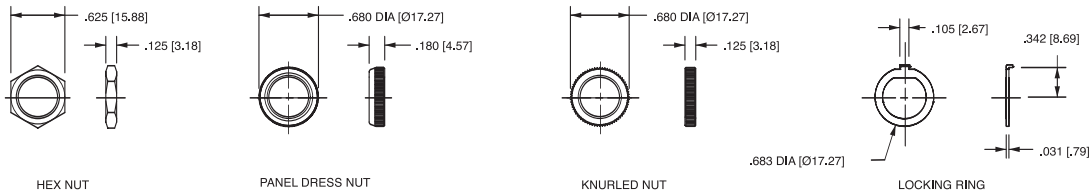

Notes:
 1 All dimensions are in inches [millimeters].
 2 Tolerance ± 0.20 [.51] unless otherwise specified.

HANDLE TYPE SHOWN WITHOUT AUX. SWITCH

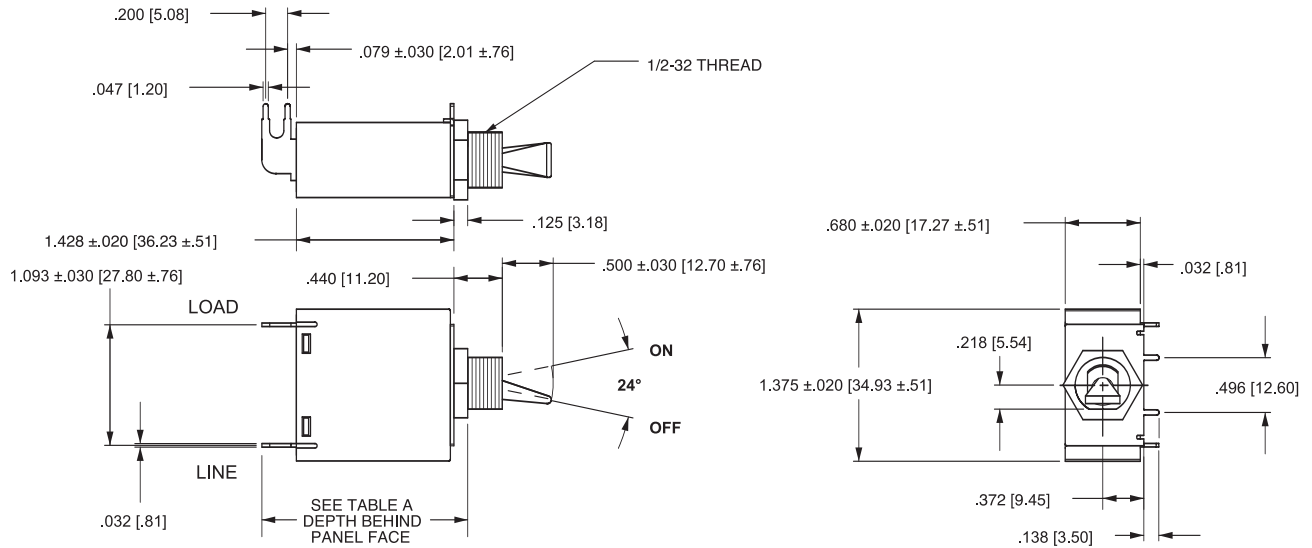

P.C. FOOTPRINT

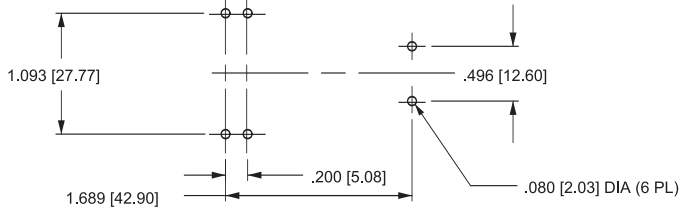

P.C. TERMINAL

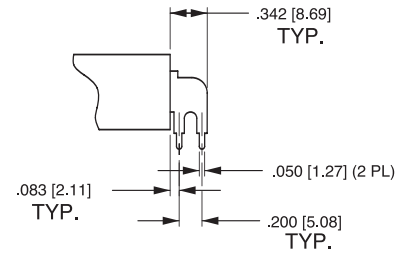

HANDLE TYPE SHOWN WITH AUX. SWITCH

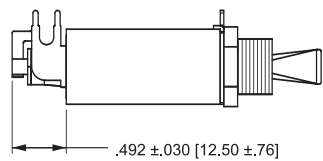

PANEL HARDWARE

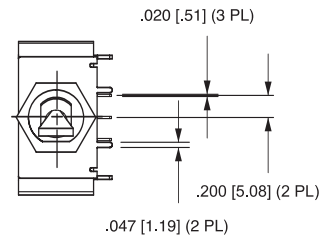
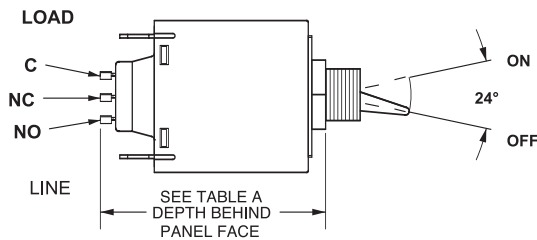
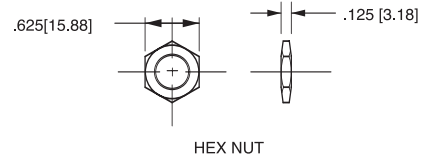

P.C. FOOTPRINT

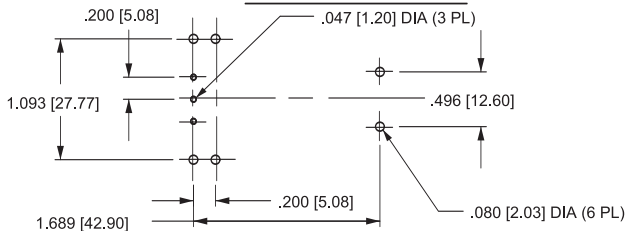

TERMINAL DESCRIPTION		DEPTH BEHIND PANEL FACE *
MAIN	PRINTED CIRCUIT BOARD	1.957 [49.71]
AUX. SWITCH	PRINTED CIRCUIT BOARD	2.449 [62.20]

*DEPTH INCLUDES BEHIND PANEL HEX NUT AS SUPPLIED ON ALL UNITS

- Notes:
 1 All dimensions are in inches [millimeters].
 2 Tolerance ±.020 [.51] unless otherwise specified.

SERIES TRIP

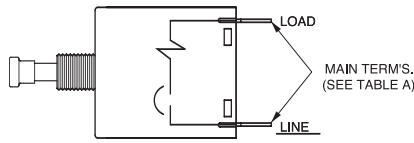

SWITCH ONLY

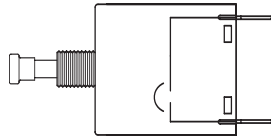

SERIES TRIP W/ AUXILIARY SWITCH

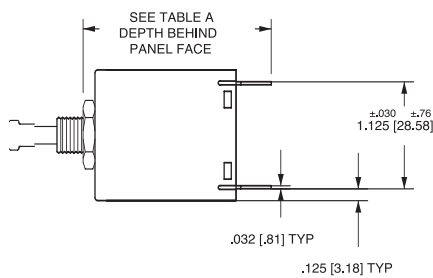
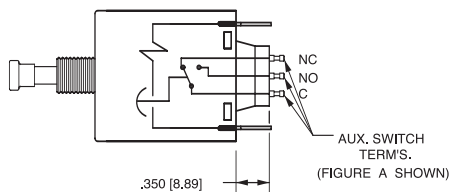

TABLE A		DEPTH BEHIND PANEL FACE *
TERMINAL DESCRIPTION		
MAIN	TAB (Q.C)	1.952 [49.57]
	SCREW (#8-32)	1.992 [50.60]
	PUSH-IN STUD	2.582 [65.58]
AUX. ** SWITCH	DOUBLE SOLDER TURRET TYPE	2.097 [53.26]
	ROUND Q.C TYPE	2.087 [53.01]
	FLAT QUICK-CONNECT	2.191 [55.65]
	FLAT SOLDER LUG	2.074 [52.68]

*DEPTH INCLUDES BEHIND PANEL HEX NUT AS SUPPLIED ON ALL UNITS.

** WHEN CALLED FOR ON MULTI-POLE UNITS, ONLY ONE AUX. SWITCH IS NORMALLY SUPPLIED, MOUNTED AS SHOWN IN FIG. A

MULTI-POLE IDENTIFICATION SCHEME

SOLDER TURRET AND ROUND QC AUX SWITCH TERMINALS

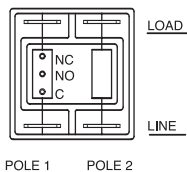

FIG. A

FLAT QC AND SOLDER LUG AUX SWITCH TERMINALS

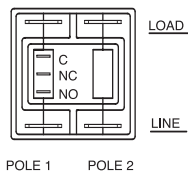
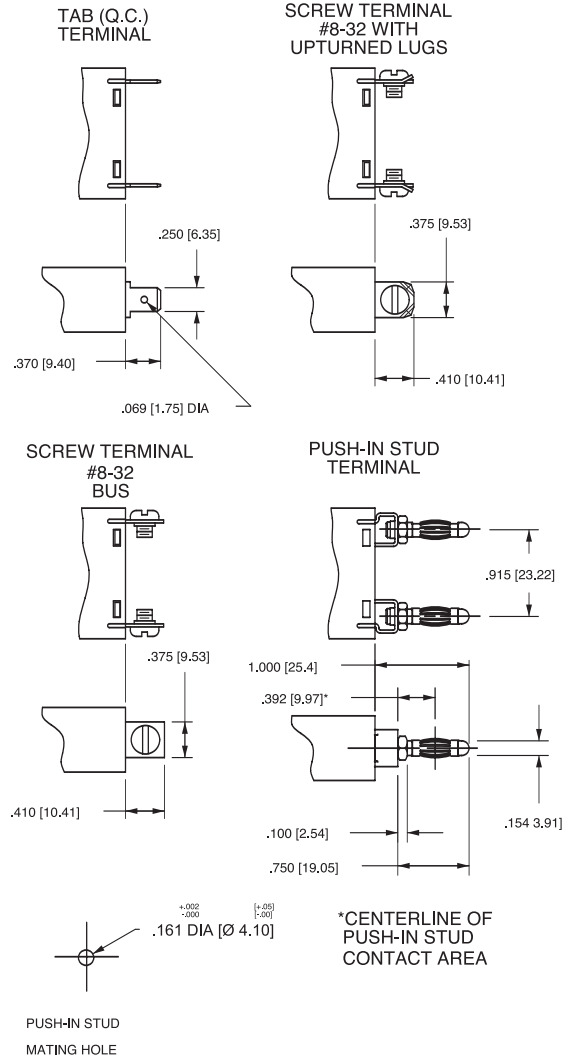

FIG. B

TERMINAL DIMENSIONAL DETAIL



*CENTERLINE OF PUSH-IN STUD CONTACT AREA

AUXILIARY SWITCH TERMINALS

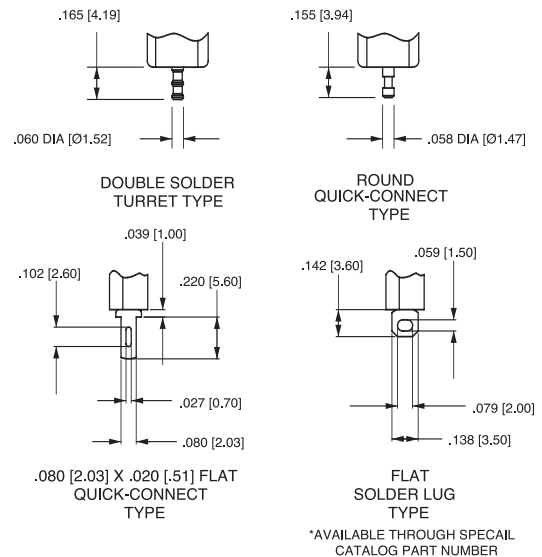

*AVAILABLE THROUGH SPECIAL CATALOG PART NUMBER

Notes:

- 1 All dimensions are in inches [millimeters].
- 2 Tolerance ±.020 [.51] unless otherwise specified.

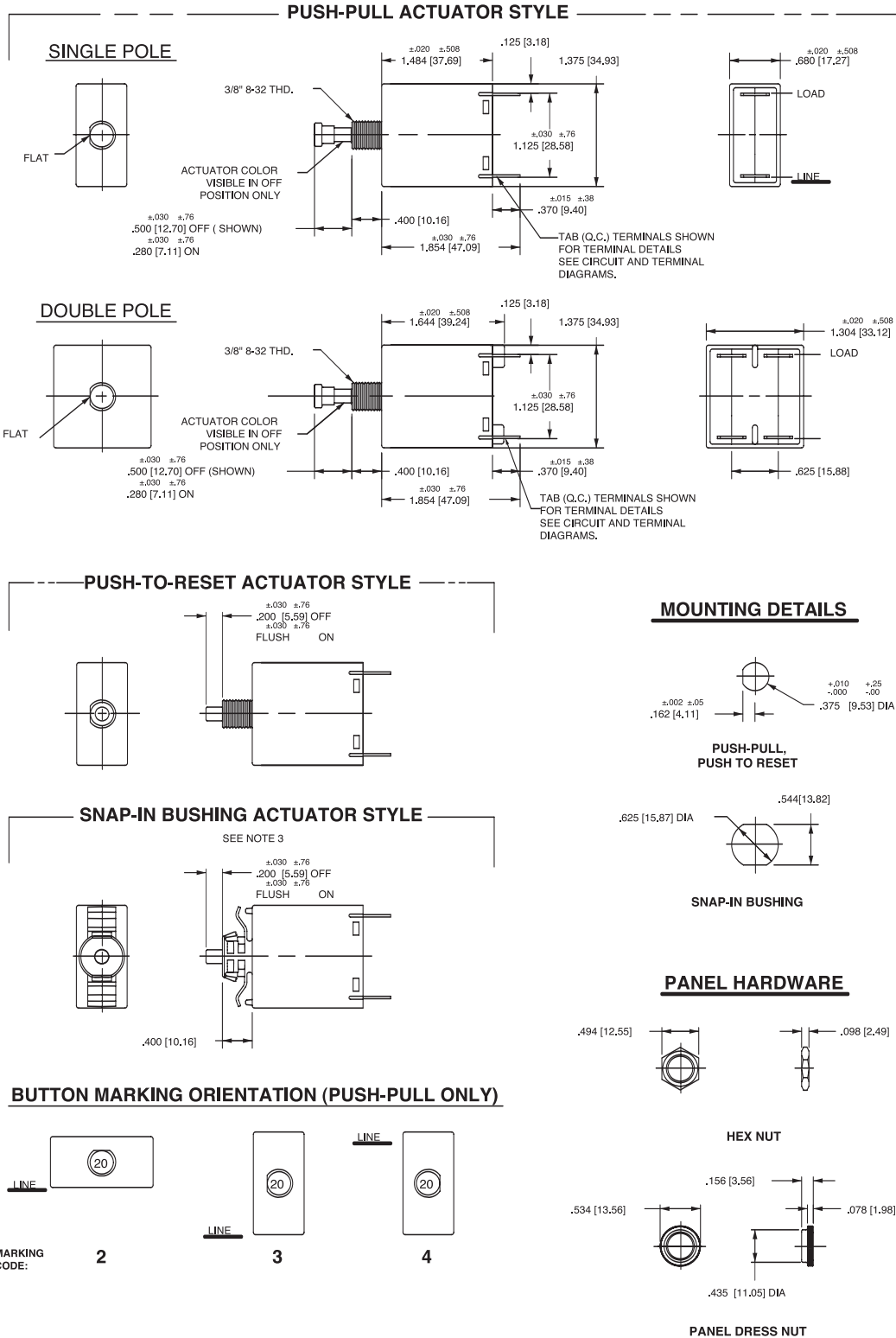

Notes:

- 1 All dimensions are in inches [millimeters].
- 2 Tolerance ± 0.20 [51] unless otherwise specified.
- 3 Available with Push-Pull or Push-to-Reset Actuators.

PUSH-PULLTYPE SHOWN WITHOUT AUX. SWITCH

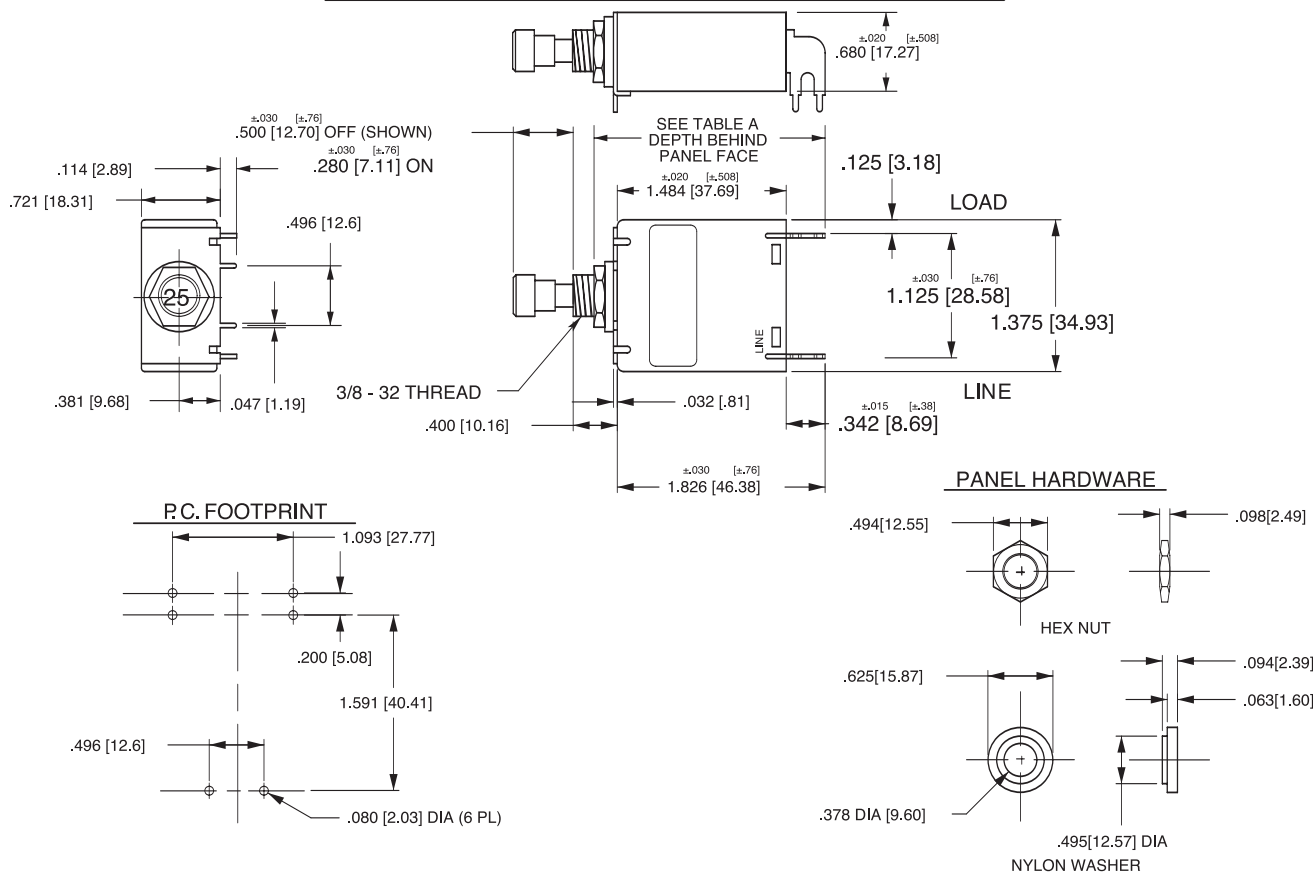

PUSH PULL TYPE SHOWN WITH AUX. SWITCH

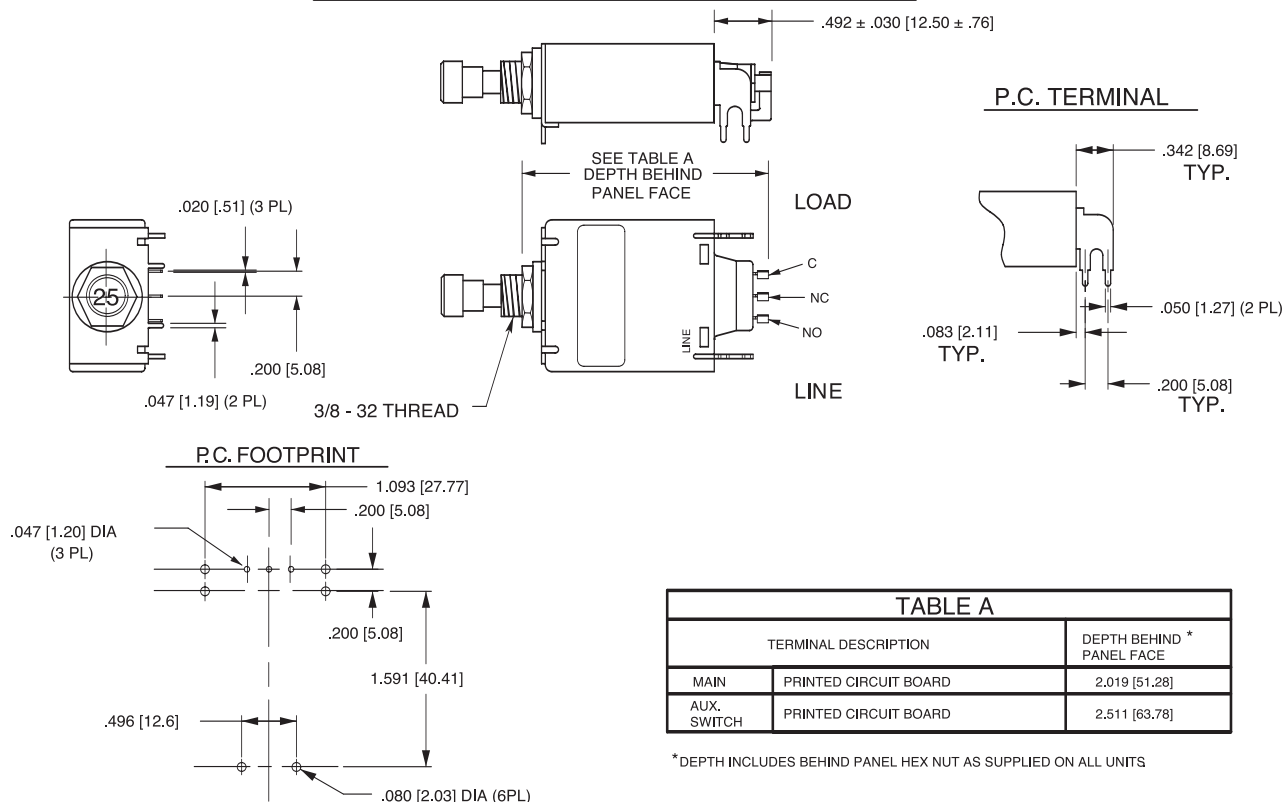
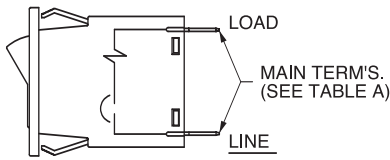

TABLE A	
TERMINAL DESCRIPTION	DEPTH BEHIND * PANEL FACE
MAIN	PRINTED CIRCUIT BOARD 2.019 [51.28]
AUX. SWITCH	PRINTED CIRCUIT BOARD 2.511 [63.78]

*DEPTH INCLUDES BEHIND PANEL HEX NUT AS SUPPLIED ON ALL UNITS

- Notes:
 1 All dimensions are in inches [millimeters].
 2 Tolerance ±.020 [.51] unless otherwise specified.

SERIES TRIP



SERIES TRIP W/ ILLUMINATED ROCKER

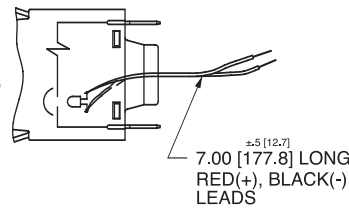

SWITCH ONLY

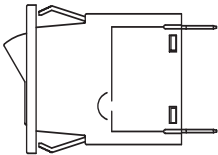

SWITCH ONLY W/ ILLUMINATED ROCKER

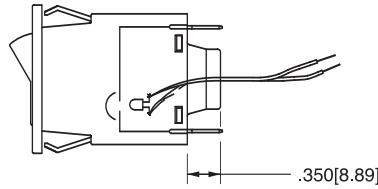

SERIES TRIP W/ AUXILIARY SWITCH

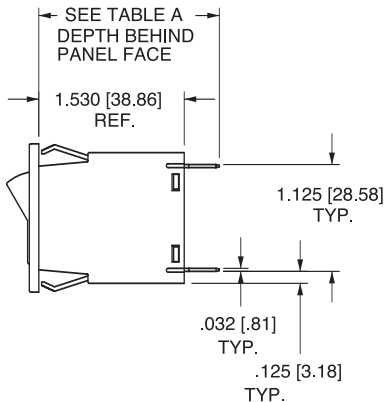
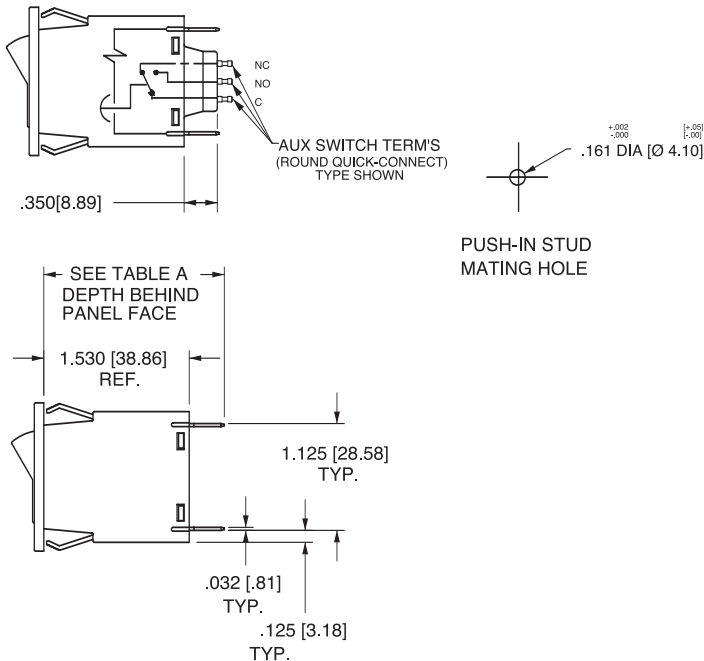
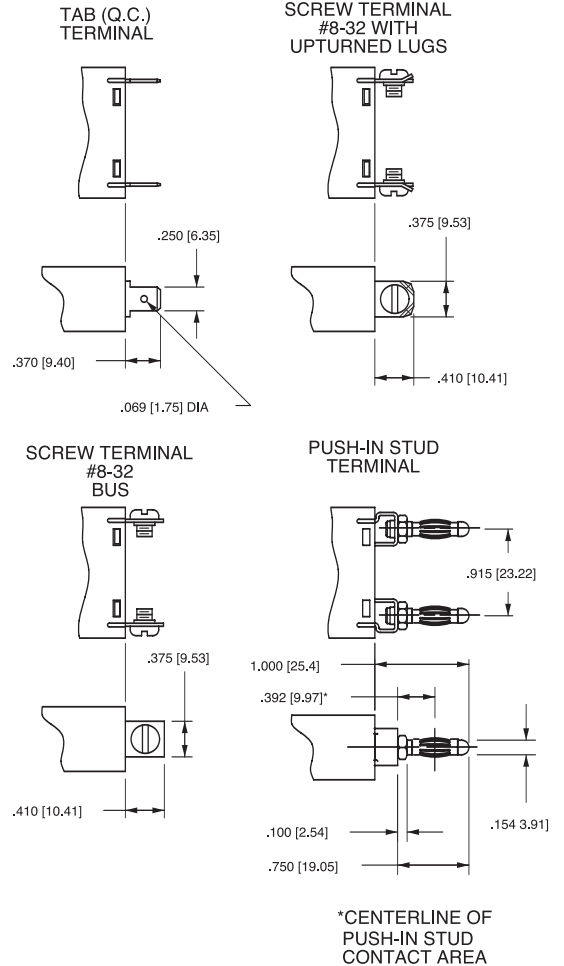

TABLE - A		
TERMINAL DESCRIPTION		DEPTH BEHIND PANEL FACE
MAIN	TAB (Q.C.)	1.900 [48.26]
	SCREW (#8-32)**	1.940 [49.28]
	PUSH-IN STUD	2.530 [64.26]
*AUX. SWITCH	DOUBLE SOLDER TURRET TYPE	2.045 [51.94]
	ROUND Q.C. TYPE	2.035 [51.69]
	FLAT QUICK CONNECT	2.139 [54.33]
	FLAT SOLDER LUG	2.022 [51.36]

* AUX. SWITCH IS NOT AVAILABLE ON SINGLE POLE ILLUMINATED UNITS. WHEN CALLED FOR ON MULTI-POLE UNITS, ONLY ONE AUX. SWITCH IS NORMALLY SUPPLIED, MOUNTED AS SHOWN ON CLA-8003.

** RECOMMENDED TIGHTENING TORQUE 12-15 IN LBS [1.4-2.7 NM]

TERMINAL DIMENSIONAL DETAIL



*CENTERLINE OF PUSH-IN STUD CONTACT AREA

AUXILIARY SWITCH TERMINALS

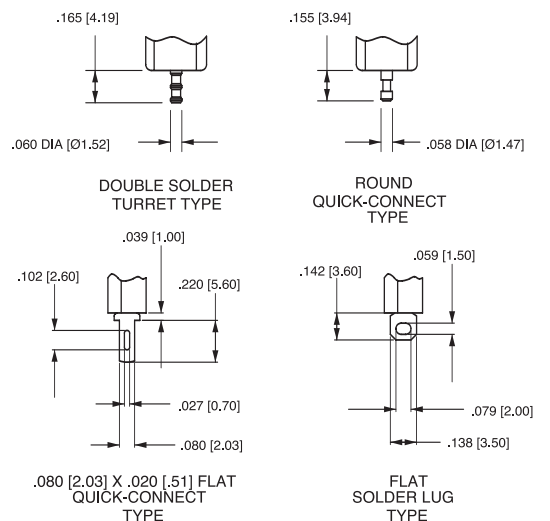

*AVAILABLE THROUGH SPECIAL CATALOG PART NUMBER

Notes:

- 1 All dimensions are in inches [millimeters].
- 2 Tolerance $\pm .020$ [.51] unless otherwise specified.
- 3 Schematic shown represents current trip circuit.

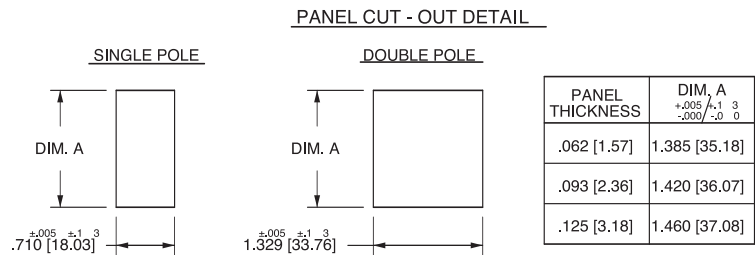
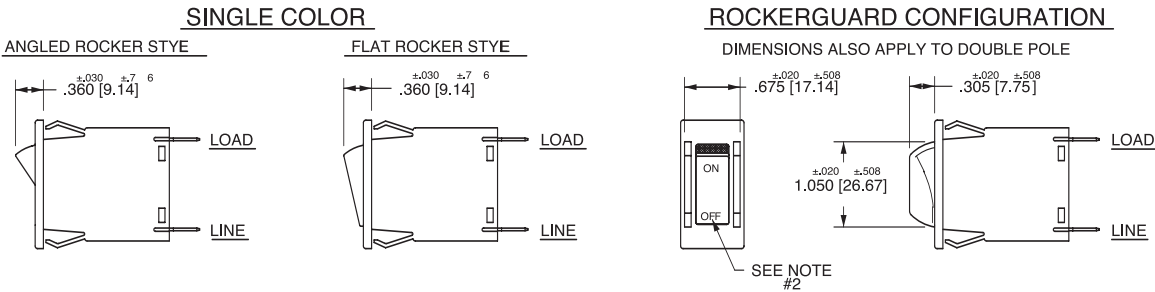
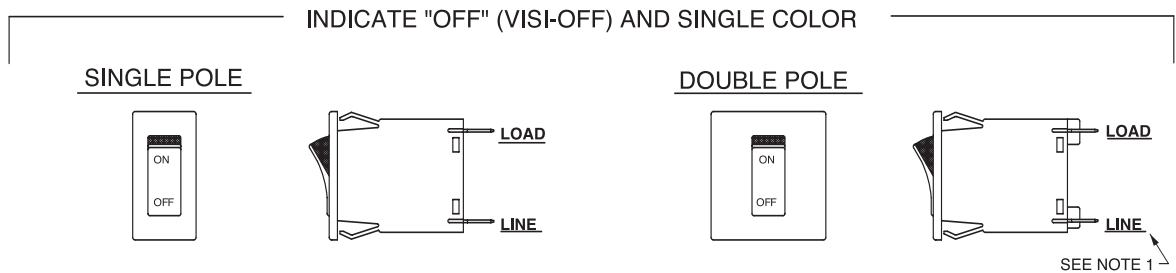
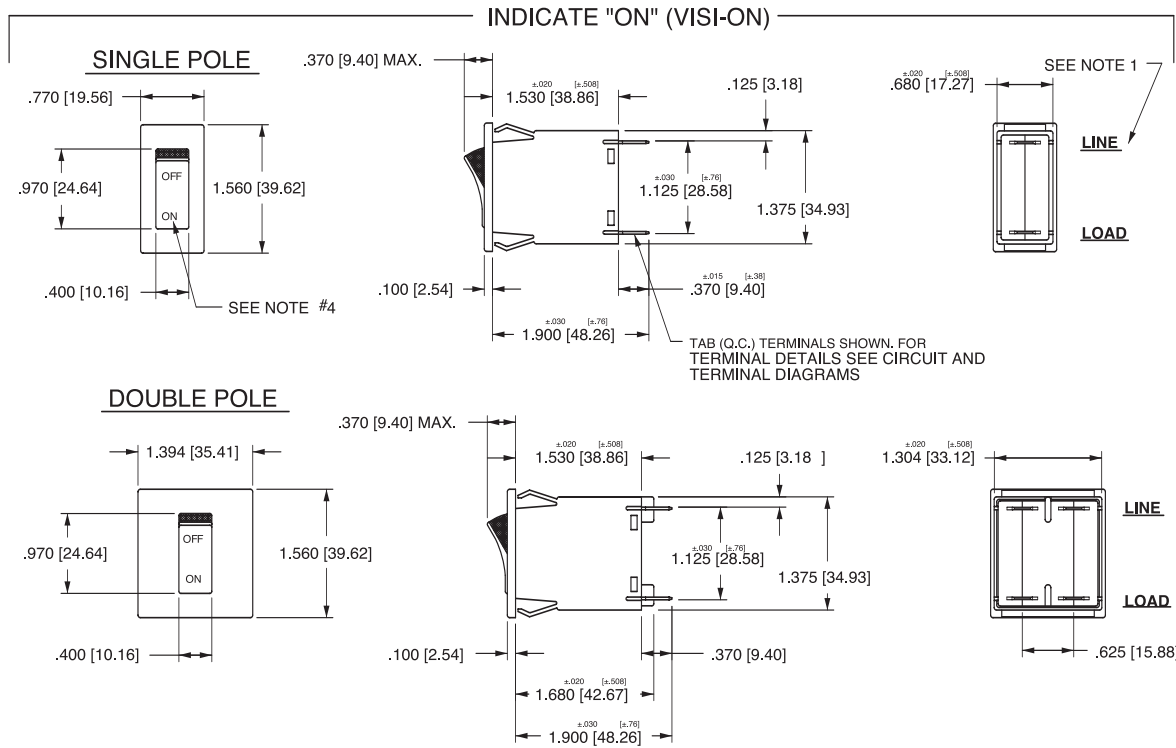

- Notes:
- 1 Dimensions apply to all variations shown. Notice that circuit breaker line & load terminal orientation on indicate OFF is opposite of indicate ON.
 - 2 I-O, ON-OFF or dual legends available for vertical or horizontal mounting. For pole orientation with horizontal legend, rotate front view clockwise 90°.
 - 3 All dimensions are in inches [millimeters].
 - 4 Tolerance ± 0.20 [.51] unless otherwise specified.

ONE POLE

SINGLE POLE / ROCKER BREAKERS SHOWN WITH DOUBLE SOLDER TURRET AND ROUND QC AUX. SWITCH TERMINALS

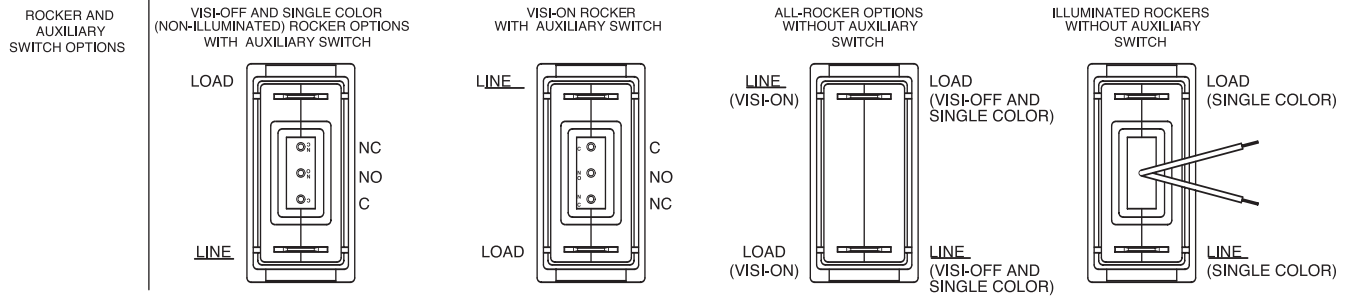

SINGLE POLE / ROCKER BREAKERS SHOWN WITH FLAT QC AND FLAT SOLDER LUG AUX. SWITCH TERMINALS

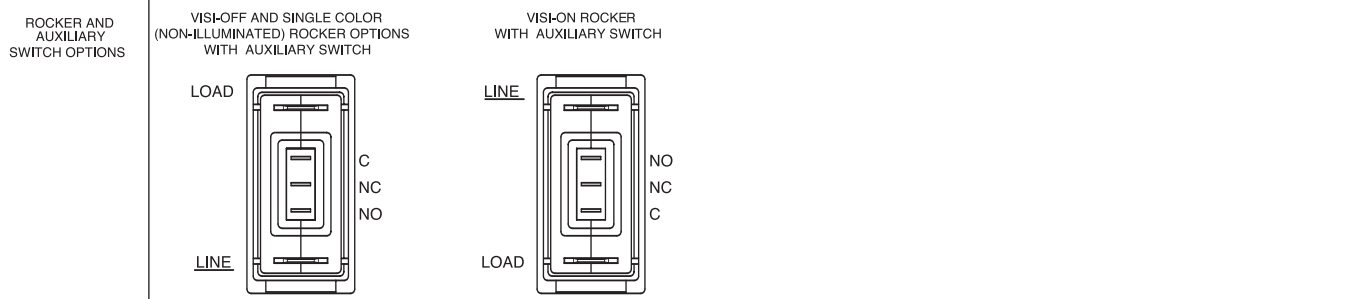

TWO POLE

DOUBLE POLE / ROCKER BREAKERS SHOWN WITH DOUBLE SOLDER TURRET AND ROUND QC AUX. SWITCH TERMINALS

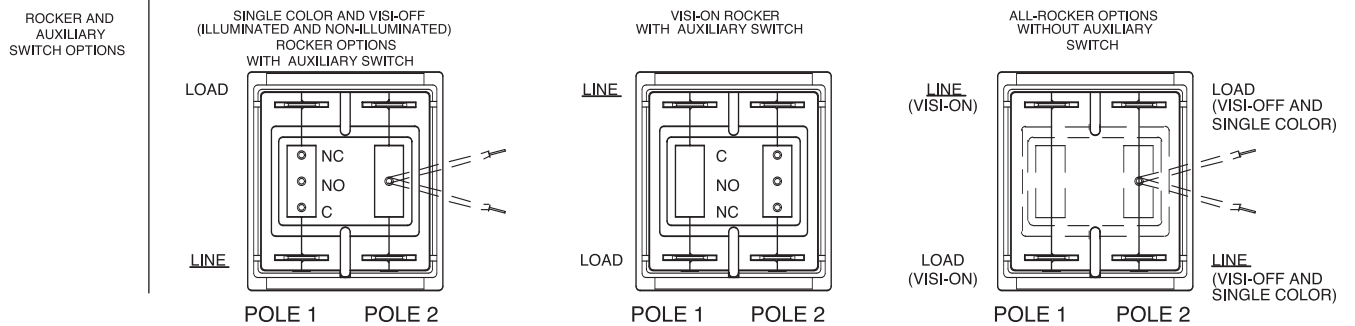

DOUBLE POLE / ROCKER BREAKERS SHOWN WITH FLAT QC AND FLAT SOLDER LUG AUX. SWITCH TERMINALS

