

## Converter - Brake - Inverter Module (CBI2)

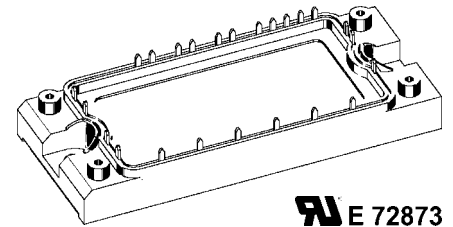
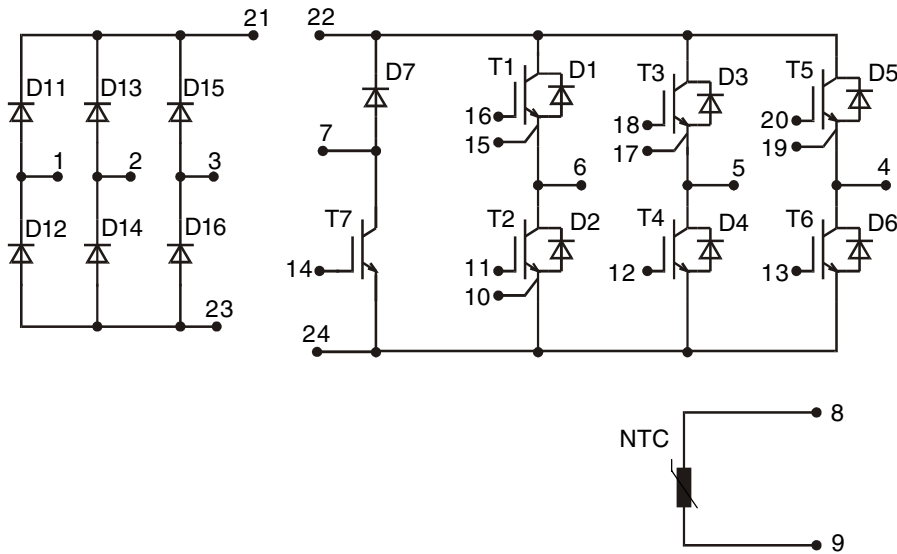

IXYS E 72873

Three Phase Rectifier	Brake Chopper	Three Phase Inverter
$V_{RRM} = 1600V$	$V_{CES} = 600 V$	$V_{CES} = 600 V$
$I_{DAVM} = 36 A$	$I_{C25} = 26 A$	$I_{C25} = 50A$
$I_{FSM} = 300 A$	$V_{CE(sat)} = 1.9 V$	$V_{CE(sat)} = 1.9 V$

### Input Rectifier Bridge D11 - D16

Symbol	Conditions	Maximum Ratings	
$V_{RRM}$		1600	V
$I_{FAV}$	$T_C = 80^\circ C$ ; sine 180°	25	A
$I_{DAVM}$	$T_C = 80^\circ C$ ; rectangular; $d = 1/3$	24	A
$I_{FSM}$	$T_{VJ} = 25^\circ C$ ; $t = 10$ ms; sine 50 Hz	300	A
$P_{tot}$	$T_C = 25^\circ C$	100	W

Symbol	Conditions	Characteristic Values ( $T_{VJ} = 25^\circ C$ , unless otherwise specified)		
		min.	typ.	max.
$V_F$	$I_F = 30 A$ ; $T_{VJ} = 25^\circ C$ $T_{VJ} = 125^\circ C$		1.5 1.4	1.7 V V
$I_R$	$V_R = V_{RRM}$ ; $T_{VJ} = 25^\circ C$ $T_{VJ} = 125^\circ C$		1.2	0.15 mA mA
$t_{rr}$	$V_R = 100 V$ ; $I_F = 15 A$ ; $di/dt = -15 A/\mu s$		1	$\mu s$
$R_{thJC}$	(per diode)			1.3 K/W

### Application: AC motor drives with

- Input from single or three phase grid
- Three phase synchronous or asynchronous motor
- electric braking operation

### Features

- High level of integration - only one power semiconductor module required for the whole drive
- Fast rectifier diodes for enhanced EMC behaviour
- NPT IGBT technology with low saturation voltage, low switching losses, high RBSOA and short circuit ruggedness
- Epitaxial free wheeling diodes with Hiperfast and soft reverse recovery
- Industry standard package with insulated copper base plate and soldering pins for PCB mounting
- Temperature sense included

**Output Inverter T1 - T6**

Symbol	Conditions	Maximum Ratings	
$V_{CES}$	$T_{VJ} = 25^{\circ}\text{C}$ to $150^{\circ}\text{C}$	600	V
$V_{GES}$	Continuous	$\pm 20$	V
$V_{GEM}$	Transient	$\pm 30$	V
$I_{C25}$	$T_C = 25^{\circ}\text{C}$	50	A
$I_{C80}$	$T_C = 80^{\circ}\text{C}$	35	A
<b>RBSOA</b>	$V_{GE} = \pm 15\text{ V}$ ; $R_G = 33\ \Omega$ ; $T_{VJ} = 125^{\circ}\text{C}$ Clamped inductive load; $L = 100\ \mu\text{H}$	$I_{CM} = 60$ $V_{CEK} \leq V_{CES}$	A
$t_{SC}$ <b>(SCSOA)</b>	$V_{CE} = V_{CES}$ ; $V_{GE} = \pm 15\text{ V}$ ; $R_G = 33\ \Omega$ ; $T_{VJ} = 125^{\circ}\text{C}$ non-repetitive	10	$\mu\text{s}$
$P_{tot}$	$T_C = 25^{\circ}\text{C}$	180	W

Symbol	Conditions	Characteristic Values ( $T_{VJ} = 25^{\circ}\text{C}$ , unless otherwise specified)		
		min.	typ.	max.
$V_{CE(sat)}$	$I_C = 30\text{ A}$ ; $V_{GE} = 15\text{ V}$ ; $T_{VJ} = 25^{\circ}\text{C}$ $T_{VJ} = 125^{\circ}\text{C}$	1.9 2.2	2.3	V V
$V_{GE(th)}$	$I_C = 0.7\text{ mA}$ ; $V_{GE} = V_{CE}$	4.5	6.5	V
$I_{CES}$	$V_{CE} = V_{CES}$ ; $V_{GE} = 0\text{ V}$ ; $T_{VJ} = 25^{\circ}\text{C}$ $T_{VJ} = 125^{\circ}\text{C}$	0.4	0.6	mA mA
$I_{GES}$	$V_{CE} = 0\text{ V}$ ; $V_{GE} = \pm 20\text{ V}$		200	nA
$t_{d(on)}$ $t_r$ $t_{d(off)}$ $t_f$ $E_{on}$ $E_{off}$	Inductive load, $T_{VJ} = 125^{\circ}\text{C}$ $V_{CE} = 300\text{ V}$ ; $I_C = 30\text{ A}$ $V_{GE} = \pm 15\text{ V}$ ; $R_G = 33\ \Omega$		50	ns
			50	ns
			270	ns
			40	ns
			1.4	mJ
			1.0	mJ
$C_{ies}$	$V_{CE} = 25\text{ V}$ ; $V_{GE} = 0\text{ V}$ ; $f = 1\text{ MHz}$	1600		pF
$Q_{Gon}$	$V_{CE} = 300\text{ V}$ ; $V_{GE} = 15\text{ V}$ ; $I_C = 30\text{ A}$	94		nC
$R_{thJC}$	(per IGBT)		0.7	K/W

**Output Inverter D1 - D6**

Symbol	Conditions	Maximum Ratings	
$I_{F25}$	$T_C = 25^{\circ}\text{C}$	72	A
$I_{F80}$	$T_C = 80^{\circ}\text{C}$	45	A

Symbol	Conditions	Characteristic Values		
		min.	typ.	max.
$V_F$	$I_F = 30\text{ A}$ ; $V_{GE} = 0\text{ V}$ ; $T_{VJ} = 25^{\circ}\text{C}$ $T_{VJ} = 125^{\circ}\text{C}$		1.2	1.6 V V
$I_{RM}$ $t_{rr}$	$I_F = 30\text{ A}$ ; $di_F/dt = -500\text{ A}/\mu\text{s}$ ; $T_{VJ} = 125^{\circ}\text{C}$ $V_R = 300\text{ V}$ ; $V_{GE} = 0\text{ V}$		25	A
			90	ns
$R_{thJC}$	(per diode)		1.19	K/W

**Equivalent Circuits for Simulation**
**Conduction**

**D11 - D16**

Rectifier Diode (typ. at  $T_J = 125^{\circ}\text{C}$ )  
 $V_0 = 1.19\text{ V}$ ;  $R_0 = 9\text{ m}\Omega$

**T1 - T6 / D1 - D6**

IGBT (typ. at  $V_{GE} = 15\text{ V}$ ;  $T_J = 125^{\circ}\text{C}$ )  
 $V_0 = 0.95\text{ V}$ ;  $R_0 = 42\text{ m}\Omega$

Free Wheeling Diode (typ. at  $T_J = 125^{\circ}\text{C}$ )  
 $V_0 = 0.89\text{ V}$ ;  $R_0 = 8\text{ m}\Omega$

**T7 / D7**

IGBT (typ. at  $V_{GE} = 15\text{ V}$ ;  $T_J = 125^{\circ}\text{C}$ )  
 $V_0 = 0.99\text{ V}$ ;  $R_0 = 81\text{ m}\Omega$

Free Wheeling Diode (typ. at  $T_J = 125^{\circ}\text{C}$ )  
 $V_0 = 1.07\text{ V}$ ;  $R_0 = 23\text{ m}\Omega$

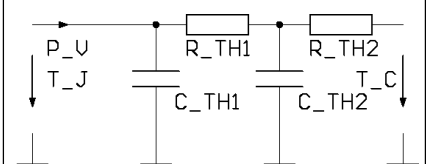
**Thermal Response**

**D11 - D16**

Rectifier Diode (typ.)  
 $C_{th1} = 0.106\text{ J/K}$ ;  $R_{th1} = 1.06\text{ K/W}$   
 $C_{th2} = 0.79\text{ J/K}$ ;  $R_{th2} = 0.239\text{ K/W}$

**T1 - T6 / D1 - D6**

IGBT (typ.)  
 $C_{th1} = 0.156\text{ J/K}$ ;  $R_{th1} = 0.545\text{ K/W}$   
 $C_{th2} = 1.164\text{ J/K}$ ;  $R_{th2} = 0.155\text{ K/W}$

Free Wheeling Diode (typ.)  
 $C_{th1} = 0.116\text{ J/K}$ ;  $R_{th1} = 0.973\text{ K/W}$   
 $C_{th2} = 0.88\text{ J/K}$ ;  $R_{th2} = 0.217\text{ K/W}$

**T7 / D7**

IGBT (typ.)  
 $C_{th1} = 0.077\text{ J/K}$ ;  $R_{th1} = 1.111\text{ K/W}$   
 $C_{th2} = 0.732\text{ J/K}$ ;  $R_{th2} = 0.279\text{ K/W}$

Free Wheeling Diode (typ.)  
 $C_{th1} = 0.043\text{ J/K}$ ;  $R_{th1} = 2.738\text{ K/W}$   
 $C_{th2} = 0.54\text{ J/K}$ ;  $R_{th2} = 0.462\text{ K/W}$

**Brake Chopper T7**

Symbol	Conditions	Maximum Ratings	
$V_{CES}$	$T_{VJ} = 25^{\circ}\text{C}$ to $150^{\circ}\text{C}$	600	V
$V_{GES}$	Continuous	$\pm 20$	V
$V_{GEM}$	Transient	$\pm 30$	V
$I_{C25}$	$T_C = 25^{\circ}\text{C}$	26	A
$I_{C80}$	$T_C = 80^{\circ}\text{C}$	19	A
<b>RBSOA</b>	$V_{GE} = \pm 15\text{ V}$ ; $R_G = 68\ \Omega$ ; $T_{VJ} = 125^{\circ}\text{C}$ Clamped inductive load; $L = 100\ \mu\text{H}$	$I_{CM} = 30$ $V_{CEK} \leq V_{CES}$	A
$t_{SC}$ <b>(SCSOA)</b>	$V_{CE} = V_{CES}$ ; $V_{GE} = \pm 15\text{ V}$ ; $R_G = 68\ \Omega$ ; $T_{VJ} = 125^{\circ}\text{C}$ non-repetitive	10	$\mu\text{s}$
$P_{tot}$	$T_C = 25^{\circ}\text{C}$	95	W

Symbol	Conditions	Characteristic Values		
		$(T_{VJ} = 25^{\circ}\text{C}$ , unless otherwise specified)		
		min.	typ.	max.
$V_{CE(sat)}$	$I_C = 15\text{ A}$ ; $V_{GE} = 15\text{ V}$ ; $T_{VJ} = 25^{\circ}\text{C}$ $T_{VJ} = 125^{\circ}\text{C}$		1.9 2.1	2.3 V V
$V_{GE(th)}$	$I_C = 0.4\text{ mA}$ ; $V_{GE} = V_{CE}$	4.5		6.5 V
$I_{CES}$	$V_{CE} = V_{CES}$ ; $V_{GE} = 0\text{ V}$ ; $T_{VJ} = 25^{\circ}\text{C}$ $T_{VJ} = 125^{\circ}\text{C}$		0.3	0.5 mA mA
$I_{GES}$	$V_{CE} = 0\text{ V}$ ; $V_{GE} = \pm 20\text{ V}$			200 nA
$t_{d(on)}$ $t_r$ $t_{d(off)}$ $t_f$ $E_{on}$ $E_{off}$	Inductive load, $T_{VJ} = 125^{\circ}\text{C}$ $V_{CE} = 300\text{ V}$ ; $I_C = 15\text{ A}$ $V_{GE} = \pm 15\text{ V}$ ; $R_G = 68\ \Omega$		30 50 270 40	ns ns ns ns
			0.7	mJ
			0.5	mJ
$C_{ies}$		$V_{CE} = 25\text{ V}$ ; $V_{GE} = 0\text{ V}$ ; $f = 1\text{ MHz}$	800	pF
$Q_{Gon}$		$V_{CE} = 300\text{ V}$ ; $V_{GE} = 15\text{ V}$ ; $I_C = 15\text{ A}$	57	nC
$R_{thJC}$				1.3 K/W

**Brake Chopper D7**

Symbol	Conditions	Maximum Ratings	
$V_{RRM}$	$T_{VJ} = 25^{\circ}\text{C}$ to $150^{\circ}\text{C}$	600	V
$I_{F25}$	$T_C = 25^{\circ}\text{C}$	22	A
$I_{F80}$	$T_C = 80^{\circ}\text{C}$	15	A

Symbol	Conditions	Characteristic Values		
		min.	typ.	max.
$V_F$	$I_F = 15\text{ A}$ ; $T_{VJ} = 25^{\circ}\text{C}$ $T_{VJ} = 125^{\circ}\text{C}$		1.5	2.2 V V
$I_R$	$V_R = V_{RRM}$ ; $T_{VJ} = 25^{\circ}\text{C}$ $T_{VJ} = 125^{\circ}\text{C}$		0.07	0.06 mA mA
$I_{RM}$ $t_{rr}$	$I_F = 10\text{ A}$ ; $di_F/dt = -400\text{ A}/\mu\text{s}$ ; $T_{VJ} = 125^{\circ}\text{C}$ $V_R = 300\text{ V}$		11 80	A ns
$R_{thJC}$				3.2 K/W

## Temperature Sensor NTC

Symbol	Conditions	Characteristic Values		
		min.	typ.	max.
$R_{25}$	$T = 25^{\circ}\text{C}$	4.75	5.0	5.25 k $\Omega$
$B_{25/50}$			3375	K

## Module

Symbol	Conditions	Maximum Ratings	
$T_{VJ}$	Operating	-40...+125	$^{\circ}\text{C}$
$T_{JM}$		150	$^{\circ}\text{C}$
$T_{stg}$		-40...+125	$^{\circ}\text{C}$
$V_{ISOL}$	$I_{ISOL} \leq 1 \text{ mA}; 50/60 \text{ Hz}$	2500	V~
$M_d$	Mounting torque (M5)	2.7 - 3.3	Nm

Symbol	Conditions	Characteristic Values		
		min.	typ.	max.
$R_{pin-chip}$			5	m $\Omega$
$d_s$	Creepage distance on surface	6		mm
$d_A$	Strike distance in air	6		mm
$R_{thCH}$	with heatsink compound		0.02	K/W
<b>Weight</b>			180	g

Dimensions in mm (1 mm = 0.0394")

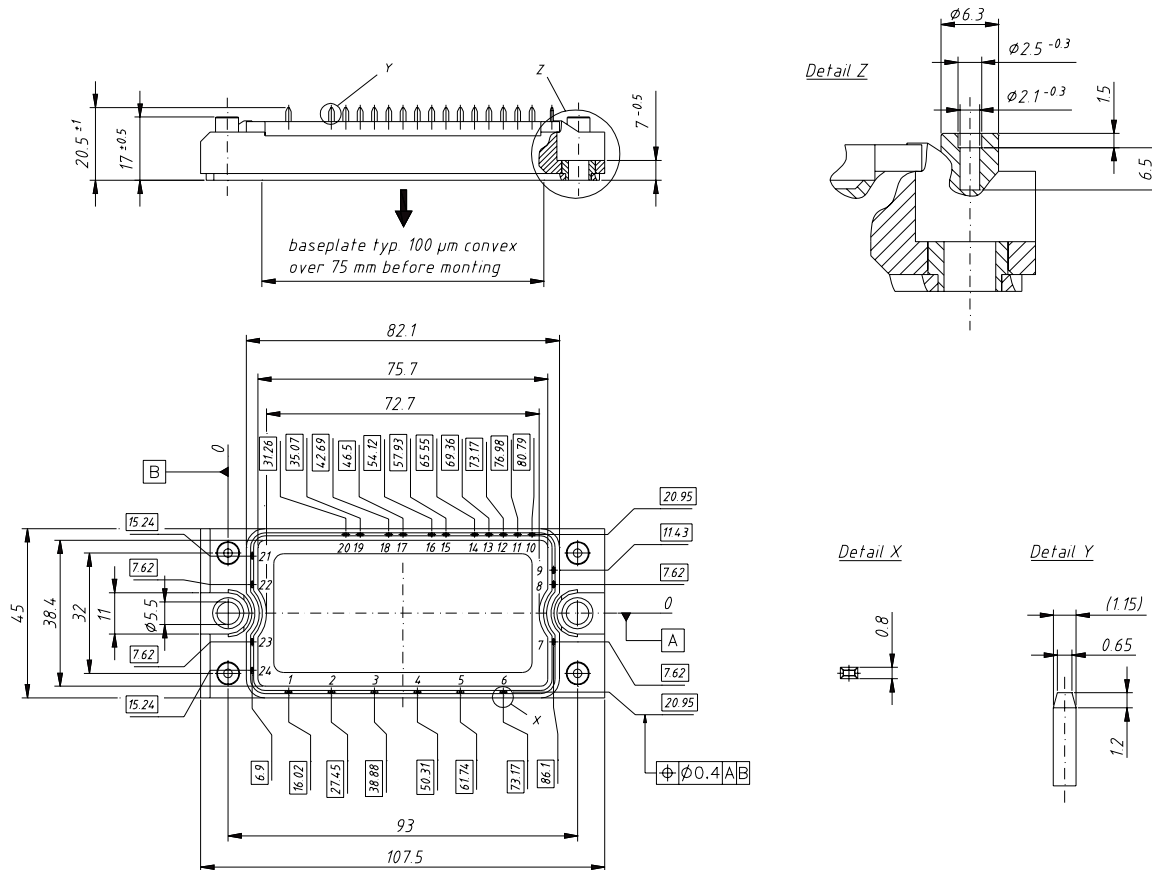

**Input Rectifier Bridge D11 - D16**

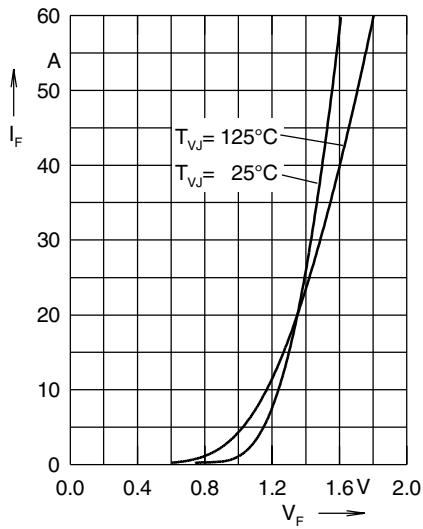

Fig. 1 Forward current versus voltage drop per diode

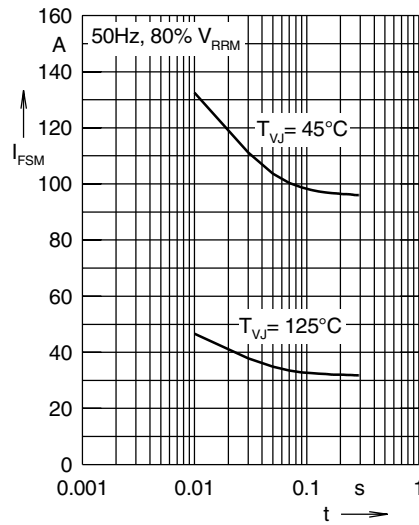

Fig. 2 Surge overload current

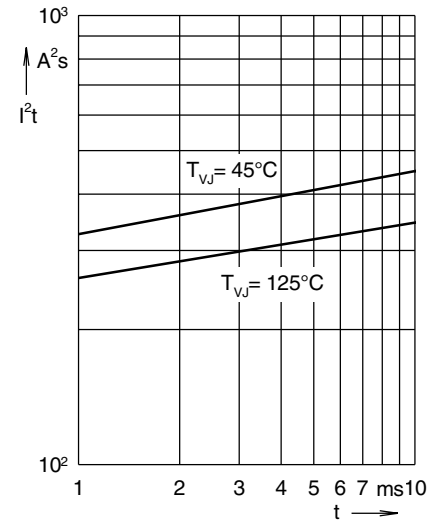

Fig. 3 I<sup>2</sup>t versus time per diode

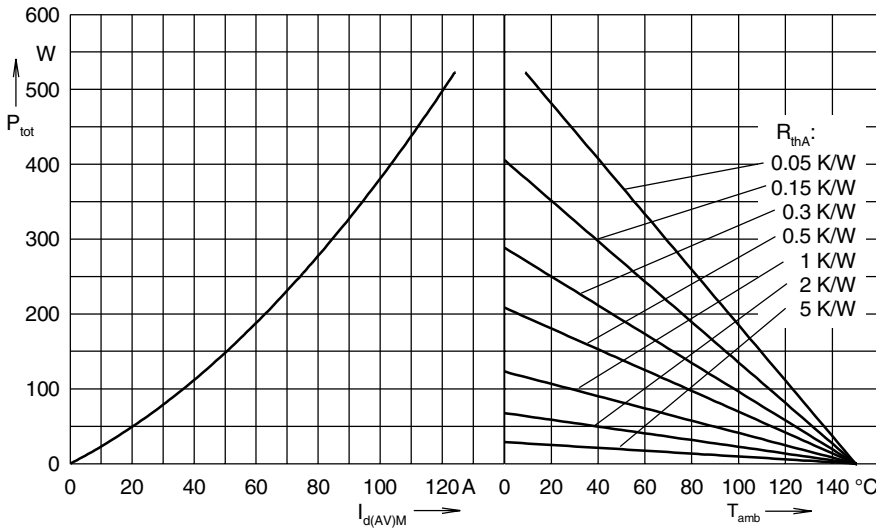

Fig. 4 Power dissipation versus direct output current and ambient temperature, sin 1 8 0

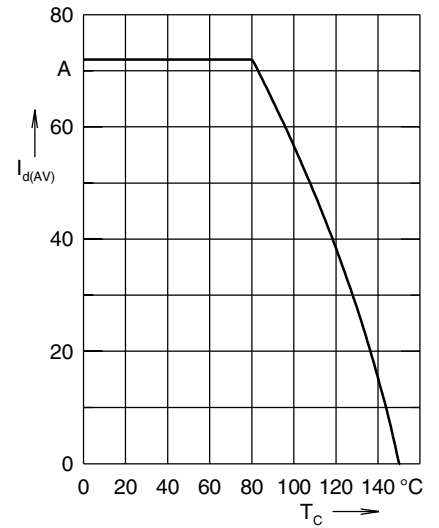

Fig. 5 Max. forward current versus case temperature

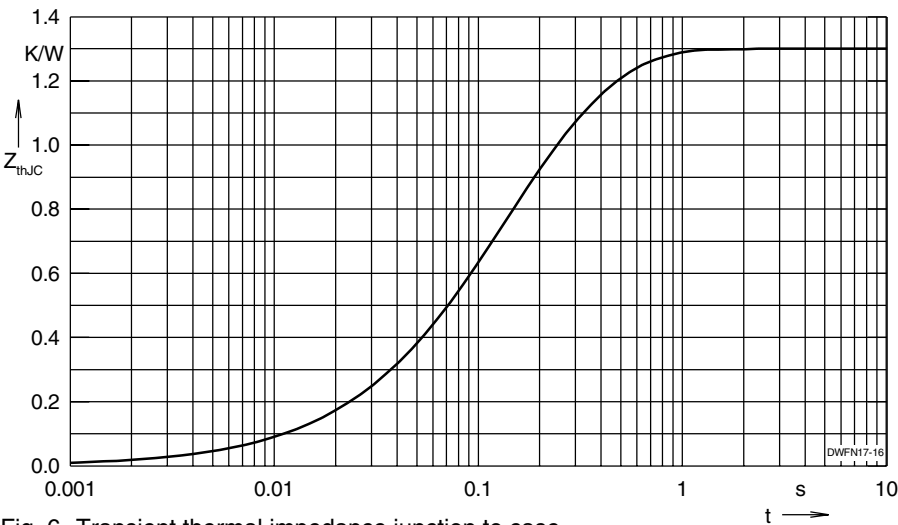

Fig. 6 Transient thermal impedance junction to case

**Output Inverter T1 - T6 / D1 - D6**

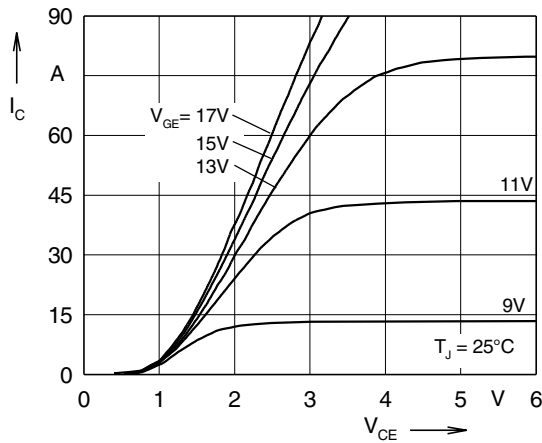

Fig. 7 Typ. output characteristics

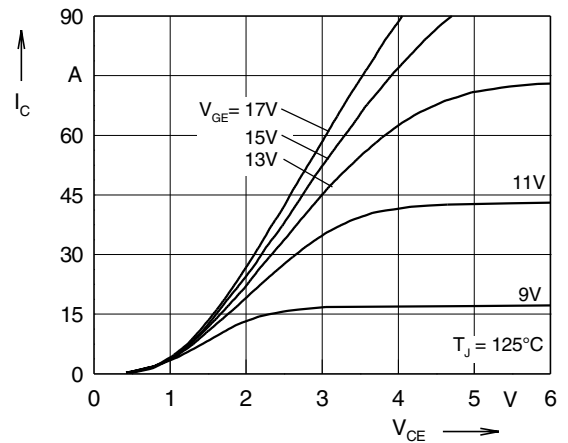

Fig. 8 Typ. output characteristics

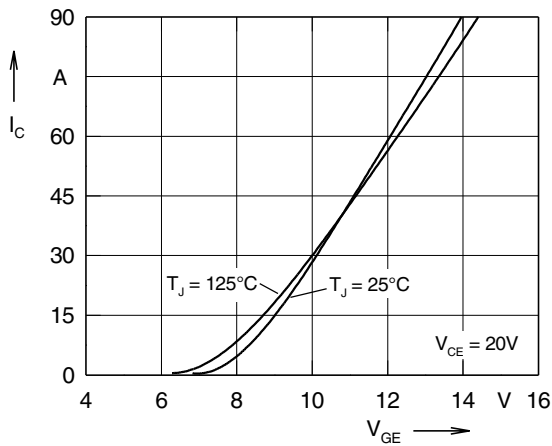

Fig. 9 Typ. transfer characteristics

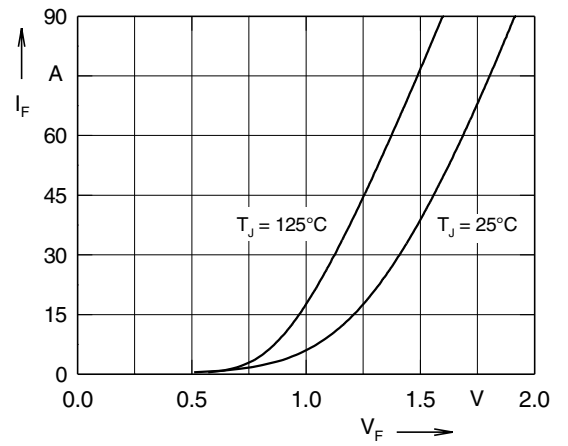

Fig. 10 Typ. forward characteristics of free wheeling diode

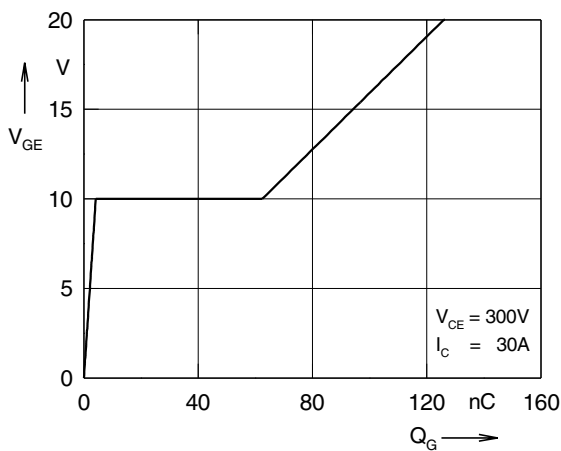

Fig. 11 Typ. turn on gate charge

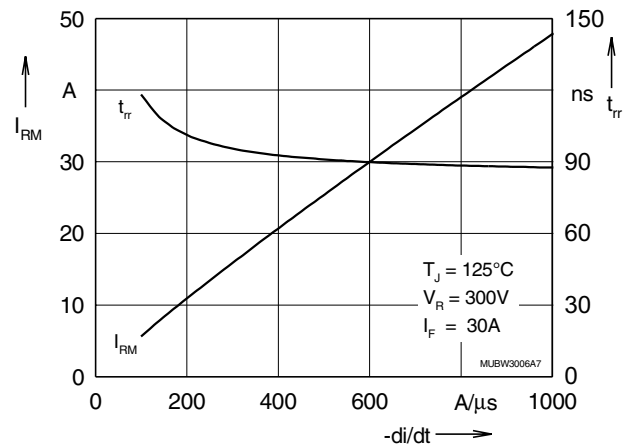

Fig. 12 Typ. turn off characteristics of free wheeling diode

Output Inverter T1 - T6 / D1 - D6

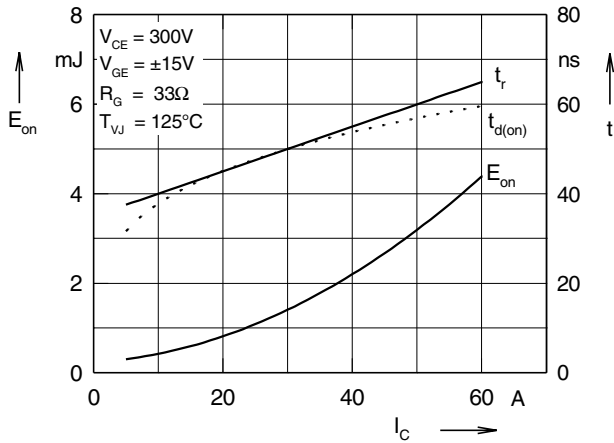

Fig. 13 Typ. turn on energy and switching times versus collector current

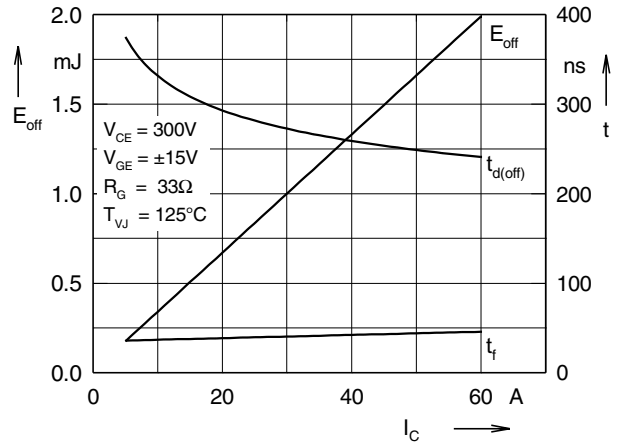

Fig. 14 Typ. turn off energy and switching times versus collector current

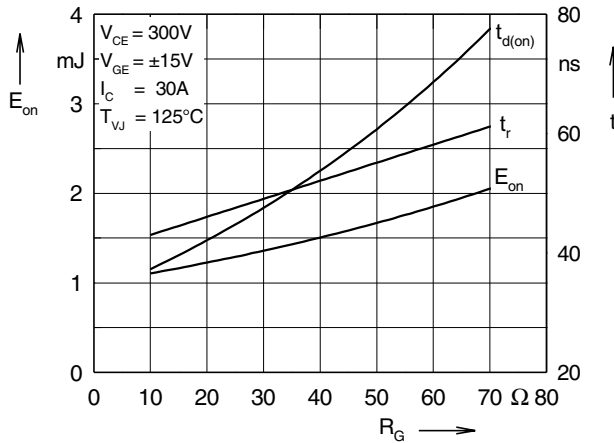

Fig. 15 Typ. turn on energy and switching times versus gate resistor

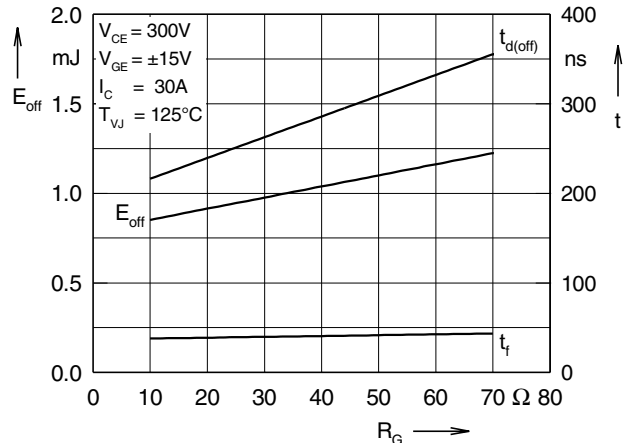

Fig. 16 Typ. turn off energy and switching times versus gate resistor

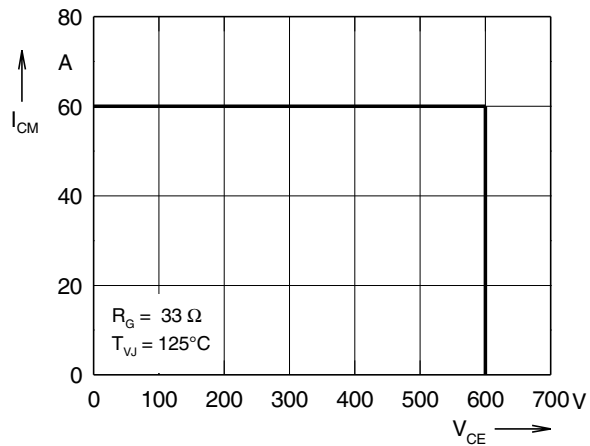

Fig. 17 Reverse biased safe operating area RBSOA

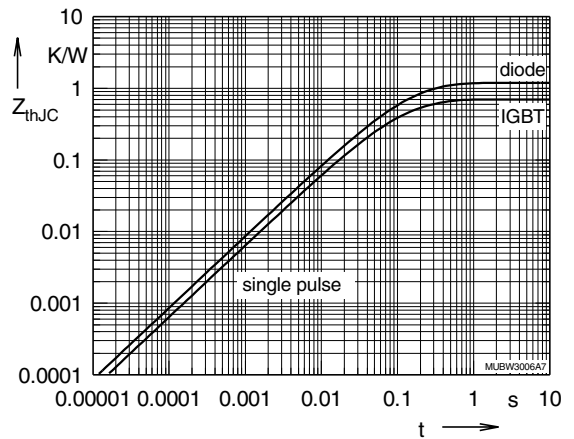

Fig. 18 Typ. transient thermal impedance

**Brake Chopper T7 / D7**

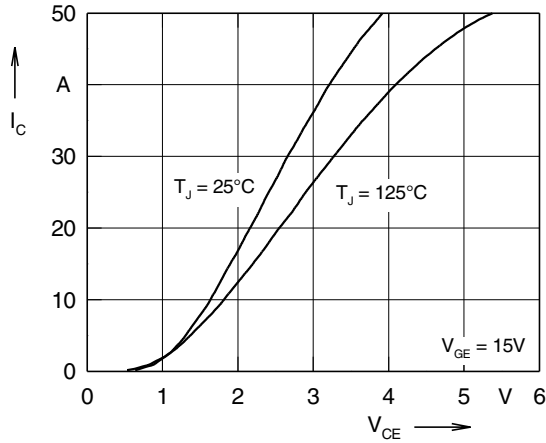

Fig. 19 Typ. output characteristics

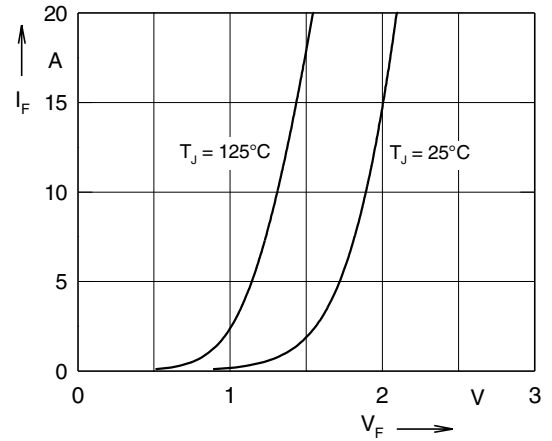

Fig. 20 Typ. forward characteristics of free wheeling diode

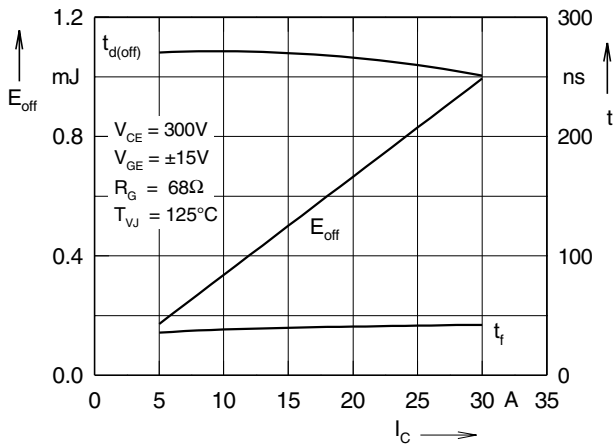

Fig. 21 Typ. turn off energy and switching times versus collector current

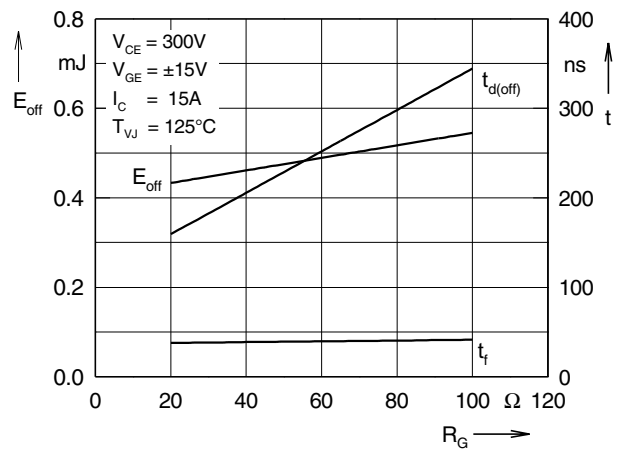

Fig. 22 Typ. turn off energy and switching times versus gate resistor

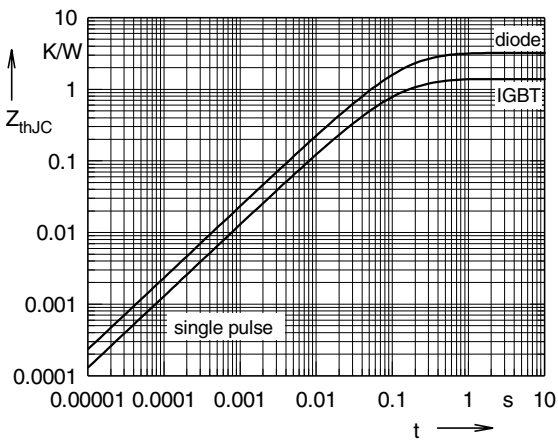

Fig. 23 Typ. transient thermal impedance

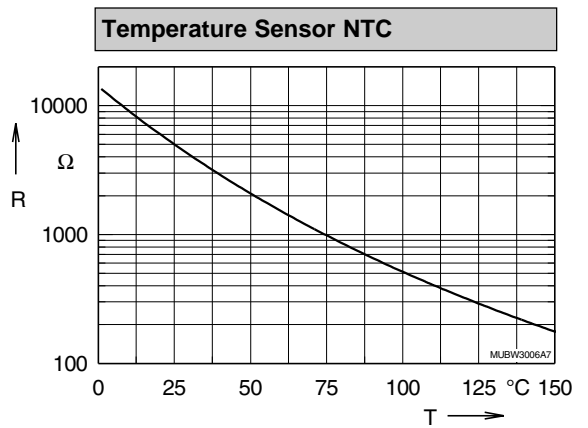

Fig. 24 Typ. thermistorresistance versus temperature