

SUPER FAST RECTIFIER

VOLTAGE RANGE: 50 --- 600 V
CURRENT: 1.0 A

FEATURES

- ◇ Low cost
- ◇ Low leakage
- ◇ Low forward voltage drop
- ◇ High current capability
- ◇ Easily cleaned with alcohol, Isopropanol and similar solvents
- ◇ The plastic material carries U/L recognition 94V-0

MECHANICAL DATA

- ◇ Case: JEDEC DO-41, molded plastic
- ◇ Terminals: Axial lead, solderable per MIL-STD-202, Method 208
- ◇ Polarity: Color band denotes cathode
- ◇ Weight: 0.012 ounces, 0.34 grams
- ◇ Mounting position: Any

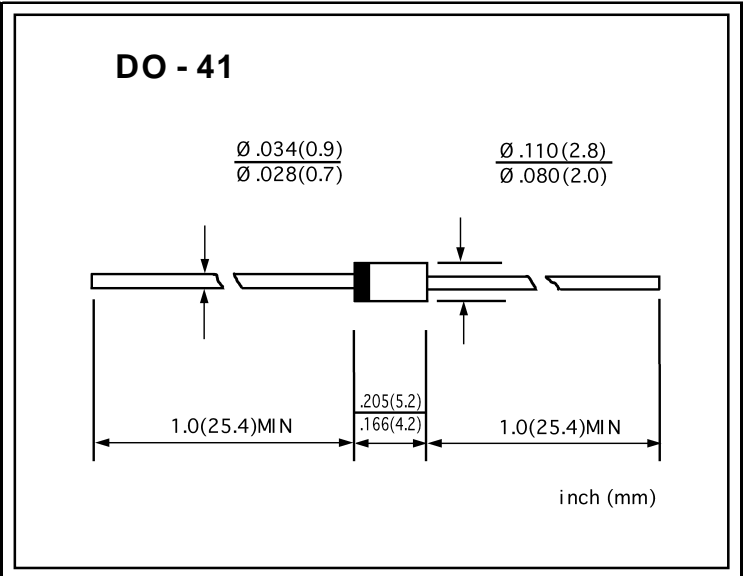

MAXIMUM RATINGS AND ELECTRICAL CHARACTERISTICS

Ratings at 25°C ambient temperature unless otherwise specified.

Single phase, half wave, 60 Hz, resistive or inductive load. For capacitive load, derate by 20%.

		MUR 105	MUR 110	MUR 115	MUR 120	MUR 130	MUR 140	MUR 150	MUR 160	UNITS
Maximum recurrent peak reverse voltage	V_{RRM}	50	100	150	200	300	400	500	600	V
Maximum RMS voltage	V_{RMS}	35	70	105	140	210	280	350	420	V
Maximum DC blocking voltage	V_{DC}	50	100	150	200	300	400	500	600	V
Maximum average forward rectified current 9.5mm lead length, @ $T_A=75^\circ C$	$I_{F(AV)}$	1.0								A
Peak forward surge current 8.3ms single half-sine-wave superimposed on rated load @ $T_J=125^\circ C$	I_{FSM}	35.0								A
Maximum instantaneous forward voltage @ 1.0A	V_F	0.875			1.2			1.25		V
Maximum reverse current @ $T_A=25^\circ C$ at rated DC blocking voltage @ $T_A=100^\circ C$	I_R	10.0 100.0								μA
Maximum reverse recovery time (Note1)	t_{rr}	25				50				ns
Typical junction capacitance (Note2)	C_J	22								pF
Typical thermal resistance (Note3)	$R_{\theta JA}$	50								$^\circ C/W$
Operating junction temperature range	T_J	- 55 ----- + 150								$^\circ C$
Storage temperature range	T_{STG}	- 55 ----- + 150								$^\circ C$

NOTE: 1. Measured with $I_F=0.5A$, $I_R=1A$, $I_{rr}=0.25A$.
2. Measured at 1.0MHz and applied reverse voltage of 4.1V DC.
3. Thermal resistance from junction to ambient.

www.galaxycn.com

FIG.1 – TYPICAL FORWARD CHARACTERISTICS

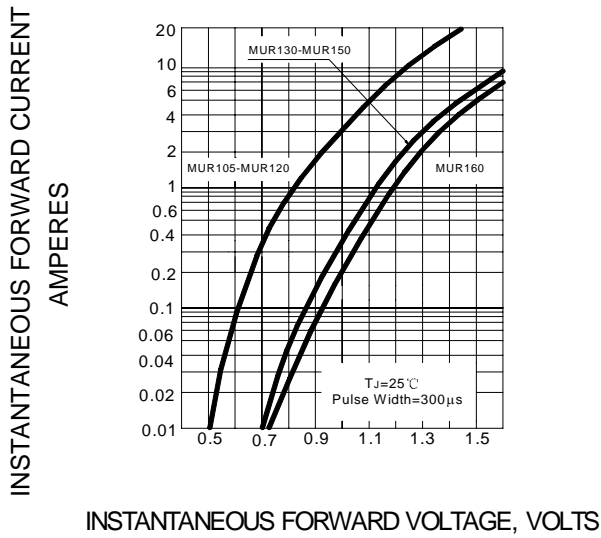

FIG.2 – FORWARD DRATING CURVE

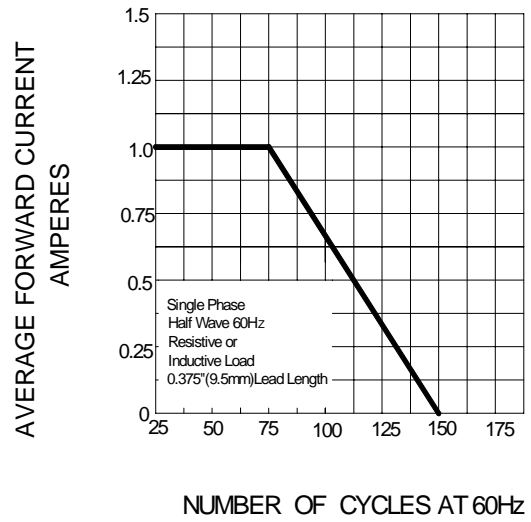
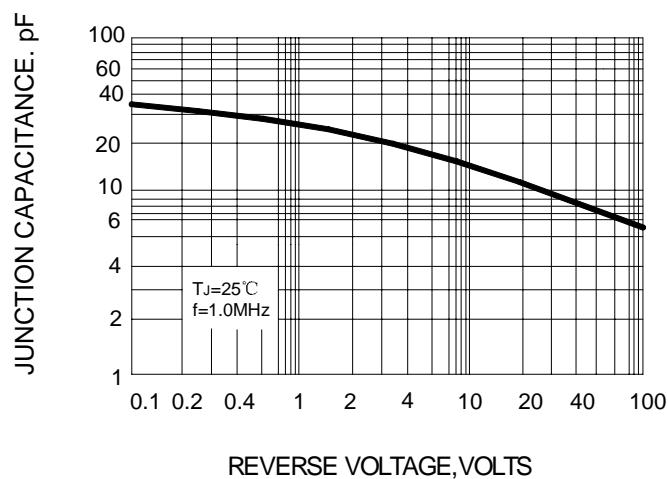
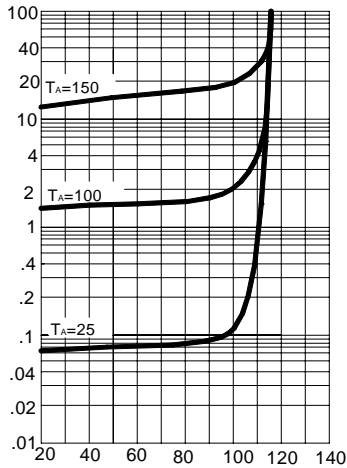

FIG.3 – TYPICAL JUNCTION CAPACITANCE



INSTANTANEOUS REVERSE LEAKAGE CURRENT
MICRO AMPERES

FIG.4 – TYPICAL REVERSE CHARACTERISTICS



PERCENT OF RATED PEAK REVERSE VOLTAGE, %

FIG.5 – PEAK FORWARD SURGE CURRENT

PEAK FORWARD SURGE CURRENT
AMPERES

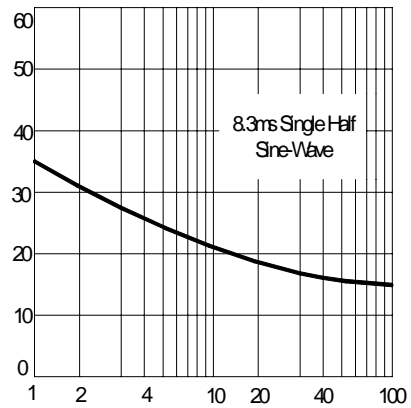

NUMBER OF CYCLES AT 60Hz

FIG.6 – TEST CIRCUIT DIAGRAM AND REVERSE RECOVERY TIME CHARACTERISTIC

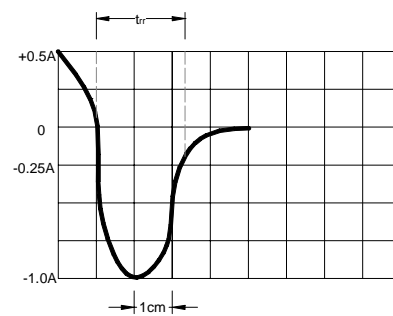
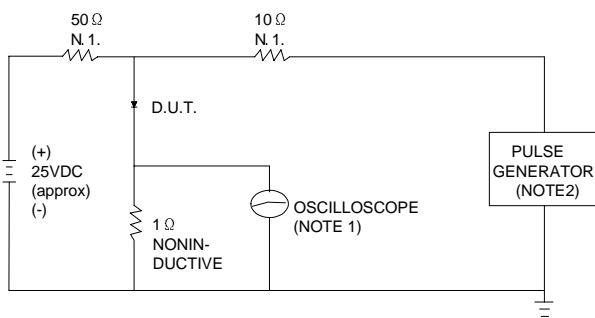

NOTES: 1. RISE TIME = 7ns MAX INPUT IMPEDANCE = 1MΩ .22pF.
2. RISE TIME = 10ns MAX SOURCE IMPEDANCE = 50Ω.

SET TIME BASE FOR 10/20 ns/cm