

# MUR120-MUR190

Super Fast Rectifiers

**VOLTAGE RANGE: 200 --- 900 V**

**CURRENT: 1.0 A**

**DO - 41**

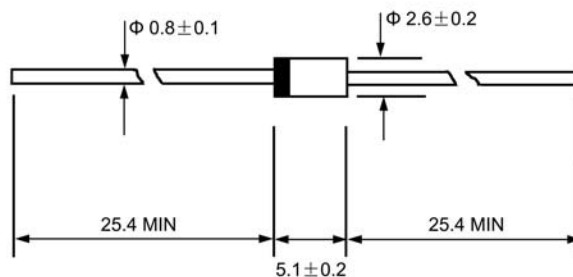

Dimensions in millimeters

## Features

- ◇ Low cost
- ◇ Low leakage
- ◇ Low forward voltage drop
- ◇ High current capability
- ◇ Easily cleaned with alcohol, Isopropanol and similar solvents
- ◇ The plastic material carries U/L recognition 94V-0

## Mechanical Data

- ◇ Case: JEDEC DO--41, molded plastic
- ◇ Polarity: Color band denotes cathode
- ◇ Weight: 0.012 ounces, 0.34 grams
- ◇ Mounting position: Any

## MAXIMUM RATINGS AND ELECTRICAL CHARACTERISTICS

Ratings at 25°C ambient temperature unless otherwise specified.

Single phase, half wave, 60 Hz, resistive or inductive load. For capacitive load, derate by 20%.

		MUR 120	MUR 130	MUR 140	MUR 150	MUR 160	MUR 170	MUR 180	MUR 190	UNITS
Maximum recurrent peak reverse voltage	$V_{RRM}$	200	300	400	500	600	700	800	900	V
Maximum RMS voltage	$V_{RMS}$	140	210	280	350	420	490	560	630	V
Maximum DC blocking voltage	$V_{DC}$	200	300	400	500	600	700	800	900	V
Maximum average forward rectified current 9.5mm lead length, @ $T_A=75^\circ\text{C}$	$I_{F(AV)}$	1.0								A
Peak forward surge current 8.3ms single half-sine-wave superimposed on rated load @ $T_J=125^\circ\text{C}$	$I_{FSM}$	35.0								A
Maximum instantaneous forward voltage @ 1.0A	$V_F$	0.875	1.25					1.7		V
Maximum reverse current @ $T_A=25^\circ\text{C}$ at rated DC blocking voltage @ $T_A=100^\circ\text{C}$	$I_R$	2.0	5.0					10.0		$\mu\text{A}$
		50	150					100		
Maximum reverse recovery time (Note1)	$t_{rr}$	25	50					75		ns
Typical junction capacitance (Note2)	$C_J$	22					15			pF
Typical thermal resistance (Note3)	$R_{\theta JA}$	50					60			$^\circ\text{C/W}$
Operating junction temperature range	$T_J$	- 55 ----- + 150								$^\circ\text{C}$
Storage temperature range	$T_{STG}$	- 55 ----- + 150								$^\circ\text{C}$

NOTE: 1. Measured with  $I_F=0.5\text{A}$ ,  $I_R=1\text{A}$ ,  $I_{rr}=0.25\text{A}$ .

2. Measured at 1.0MHz and applied reverse voltage of 4.0V DC.

3. Thermal resistance from junction to ambient.

## Ratings AND Characteristic Curves

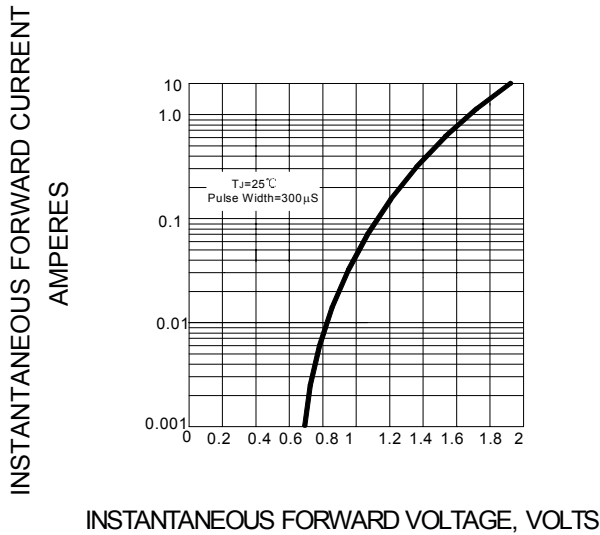
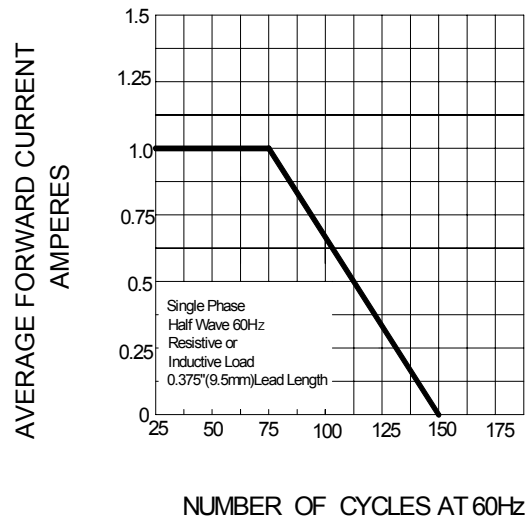
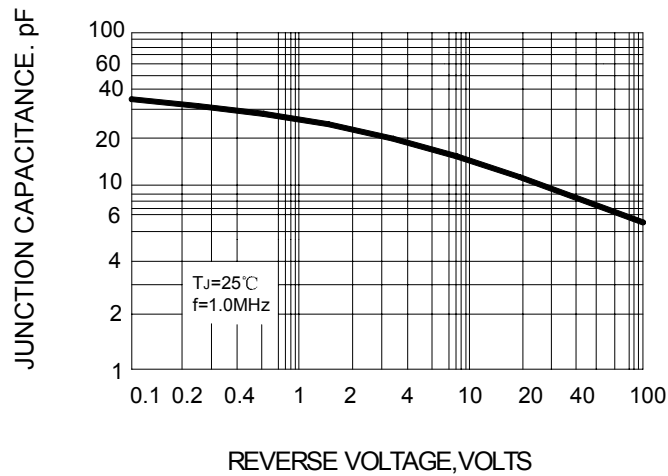
**FIG.1 – TYPICAL FORWARD CHARACTERISTICS**

**FIG.2 – FORWARD DRATING CURVE**

**FIG.3 – TYPICAL JUNCTION CAPACITANCE**

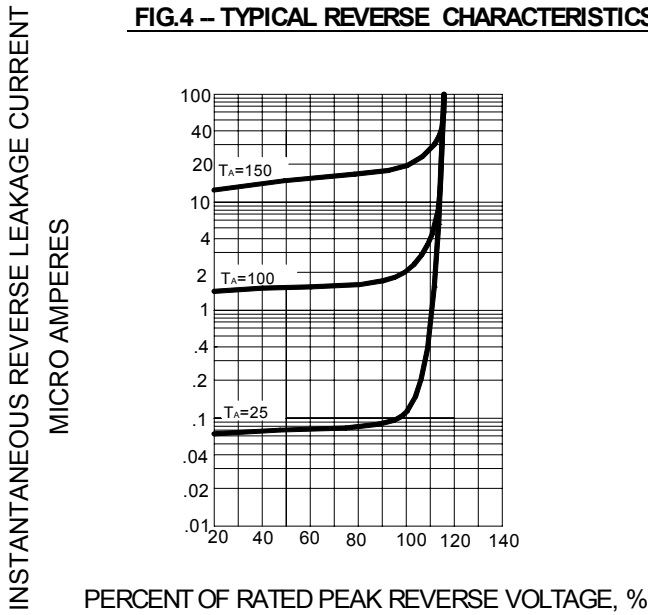
## Ratings AND Characteristic Curves

**FIG.4 – TYPICAL REVERSE CHARACTERISTICS**

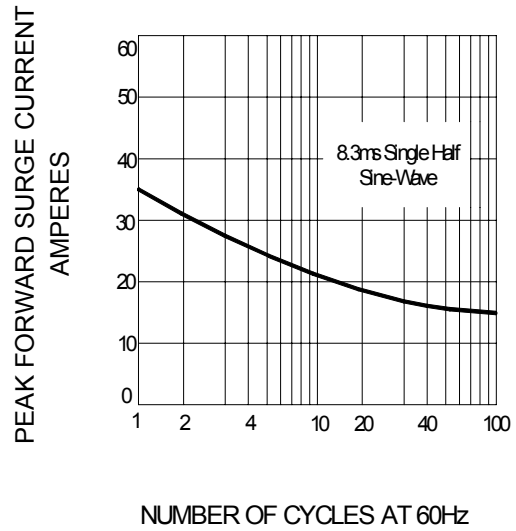

**FIG.5 – PEAK FORWARD SURGE CURRENT**



**FIG.6 – TEST CIRCUIT DIAGRAM AND REVERSE RECOVERY TIME CHARACTERISTIC**

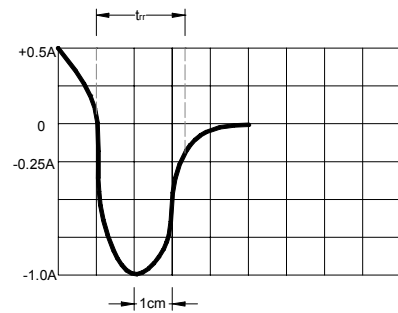
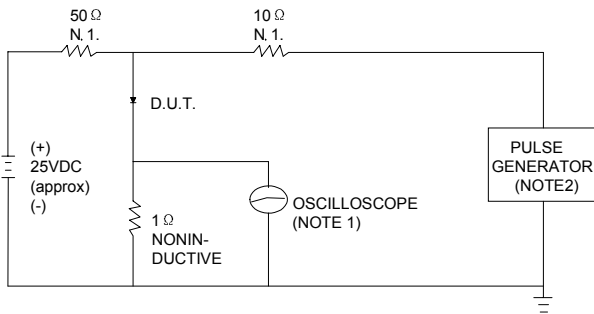

NOTES: 1. RISE TIME = 7ns MAX INPUT IMPEDANCE = 1MΩ .22pF.  
 2. RISE TIME = 10ns MAX SOURCE IMPEDANCE = 50Ω.

SET TIME BASE FOR 10/20 ns/cm