

Product Specification

GOODARK Type

MUR1640FCT/MUR1640CT

Construction : Ultra Fast Recover diode

Application : For power switch

(Manufacturer) :

Suzhou Goodark Electronics Co.,Ltd

Prepared on Sep. 17th, 2008

Prepared: R & D Department

Approval:

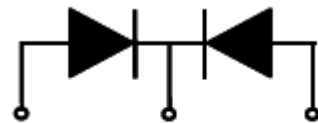

1. Anode 2.Cathode 3. Anode

CONTENTS

1. Package Outline
2. Marking
3. Features& Mechanical Characteristics
4. Maximum Ratings and Electrical Characteristics
5. Rating and characteristic Curves
6. Packing Specification PACKAGING SPECIFICATION
7. Description of Box Label

1. Package Outline (TO220F-AB)

UNIT:mm

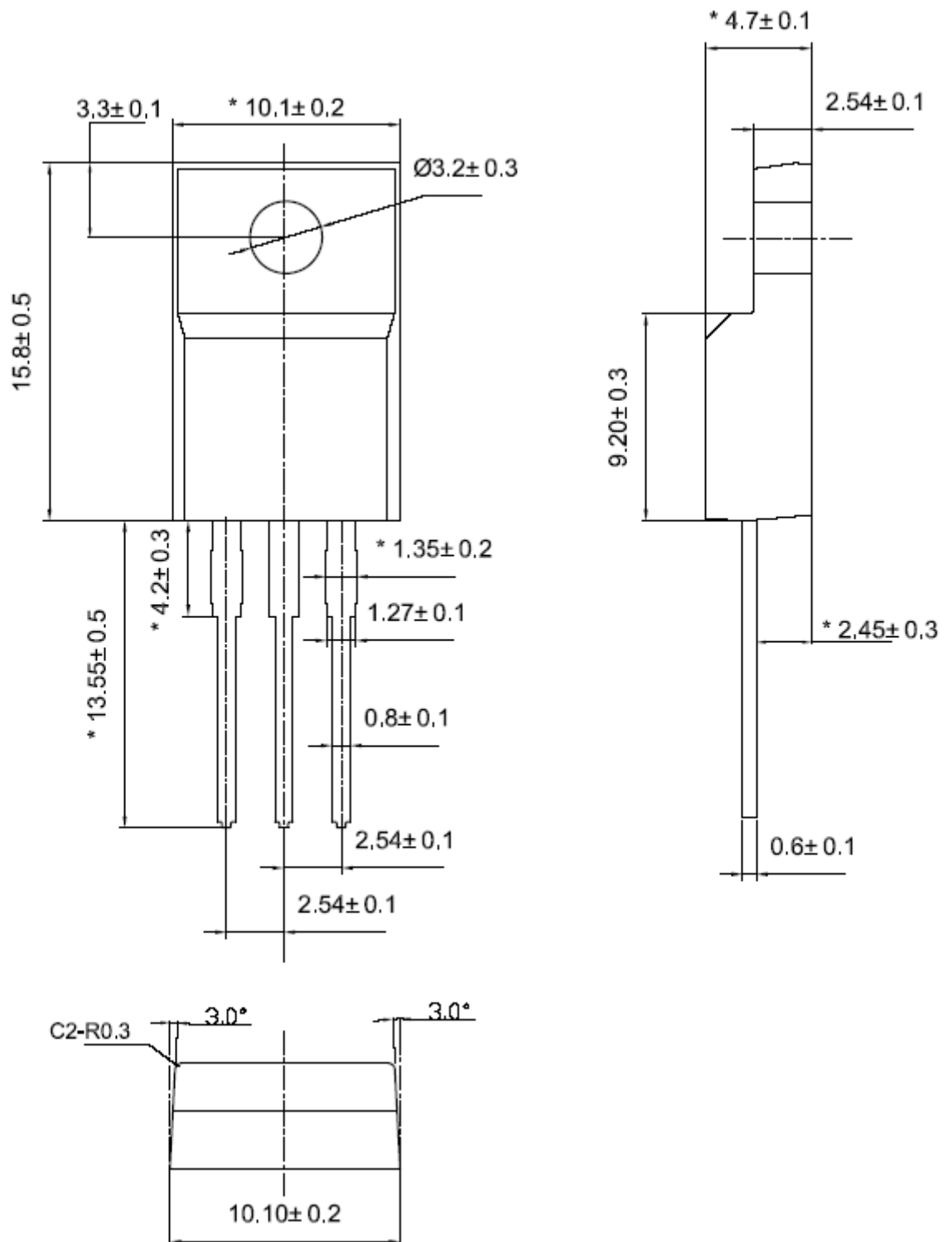

Package Outline (TO220-AB)

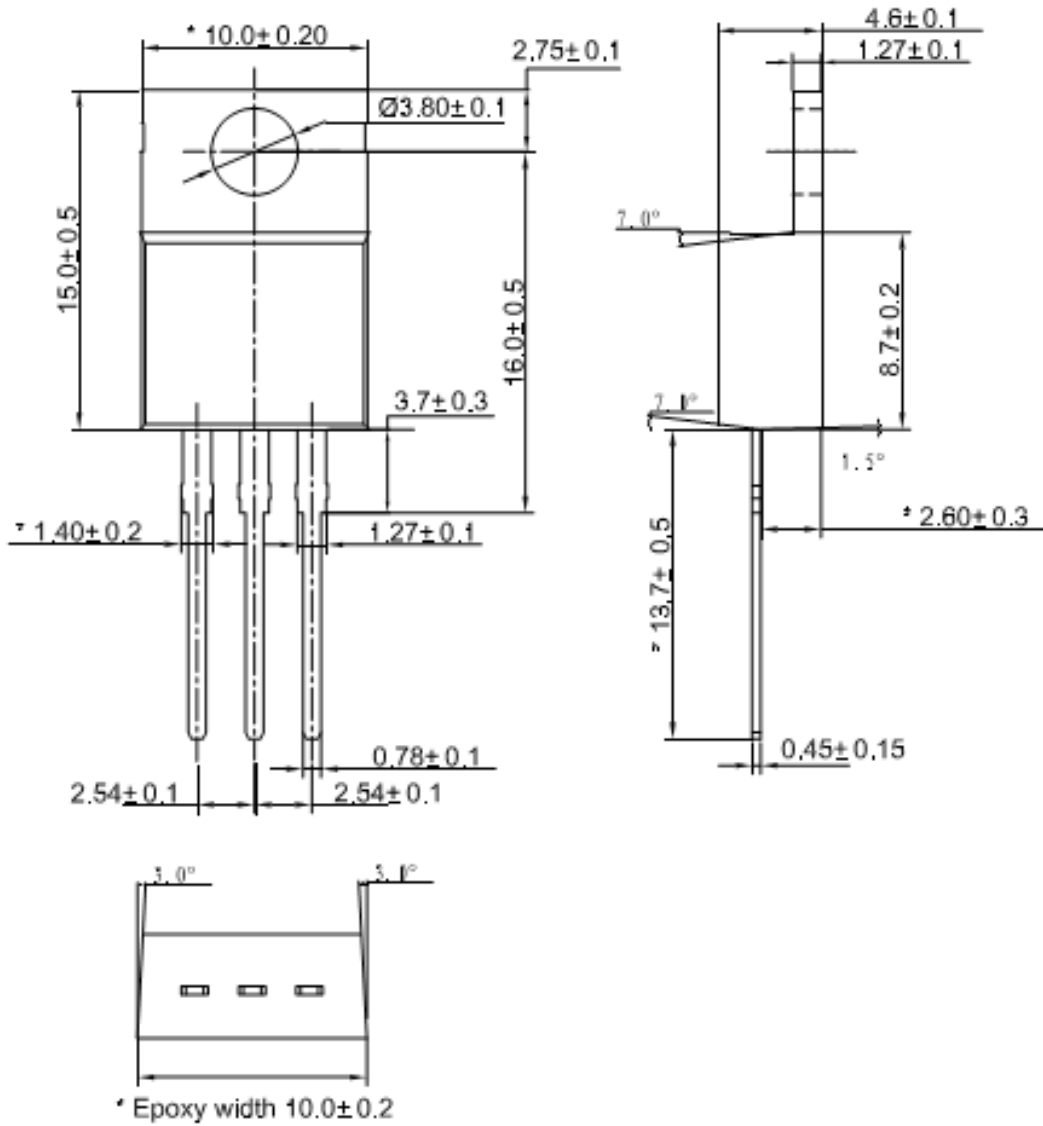

Lead Frame Material : Copper Plating: Pure Tin Plating

2. MARKING

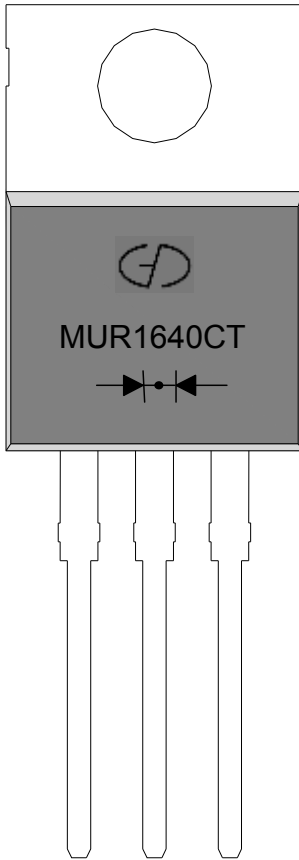

1. Part Name : MUR1640FCT(TO220F)
MUR1640CT(TO220AB)

2. Logo Mark: 

3. Polarity: 



3.Features& Mechanical Characteristics

Features

- Plastic package has underwriters Laboratory Flammability Classification 94V-0
- Dual rectifier construction, positive center tap
- Metal of silicon rectifier, majority carrier conduction
- Low forward voltage, high efficiency
- Guarding for over voltage protection
- For use in low voltage, high frequency inverters,
- Free wheeling, and polarity protection applications

Mechanical Characteristics

- Case: Epoxy, Molded
- Weight: 1.9grams (approximately)
- Finish: All External Surfaces Corrosion Resistant and Terminal Leads are Readily Solderable
- Lead Temperature for Soldering Purposes: 260°C Max.for10 sec
- Shipped 50 units per plastic tube

4.Maximum Ratings and Electrical Characteristics

MAXIMUM RATINGS and ELECTRICAL CHARACTERISTICS(TC=25°C unless otherwise moted)					
PARAMETER	TEST CONDITIONS		SYMBOL	MUR1640(F)CT	UNIT
Maximum repetitive peak reverse voltage			VRRM	400	V
Working peak reverse voltage			VRWM	400	V
Maximum DC blocking voltage			VDC	400	V
Maximum average forward rectified current at Tc=105°C total device per diode	Per Leg		IF(AV)	8	A
	Per device			16	
Peak forward surge current 8.3ms single half sine-wave superimposed on rated load per diode			IFSM	125	A
Operating junction temperature range			TJ	-55 to+150	°C
Isolation voltage (ITO-220AB only) from terminal to heatsink t = 1 sec			VAC	1500	V
Storage temperature range			TSTG	-55 to+150	°C
Maximum instantaneous forward voltage per leg	IF=8A	TC=25°C	VF	1.30	V
	IF=8A	TC=125°C		1.20	
Maximum reverse current per leg at working peak Reverse voltage			IR	50	uA
				TJ=25°C	
		TJ=100°C			
Maximum Reverse Recover Time (If=0.5Amp, IR=1.0Amp,Irec=0.25Amp)	Trr		Trr	50	ns

Thermal Characteristics Ta=25°C unless otherwise noted

Symbol	Parameter	Type (TO220AB)	Type (TO220F)	Unit
RθJC	Thermal Resistance, Junction to Case per Leg	2.0	4.0	°C /W
RθJA	Thermal Resistance, Junction to Ambient per Leg	62.5	62.5	°C /W

Note:

1. Screw mounting with 4-40 screw, where washer diameter is ≤4.9mm(0.19 ")
2. Pulse test:300us pulse width,1% duty cycle



5. Rating and Characteristic Curves

FIG.1- CURRENT DERATING, CASE, PER LEG

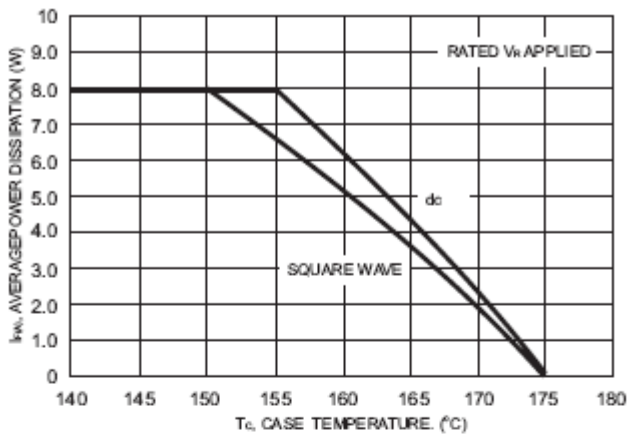
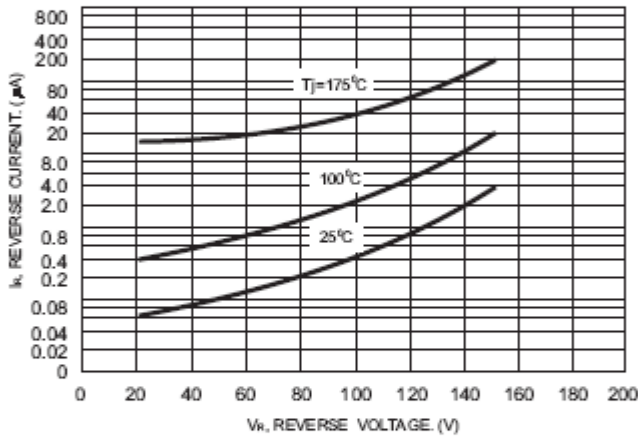

FIG.2- TYPICAL REVERSE CURRENT, PER LEG



*The curves shown are typical for highest voltage device in the voltage grouping. Typical reverse current for lower voltage selections can be estimated from these same curves if V_R is sufficiently below rated V_R.

FIG.3- TYPICAL FORWARD VOLTAGE, PER LEG

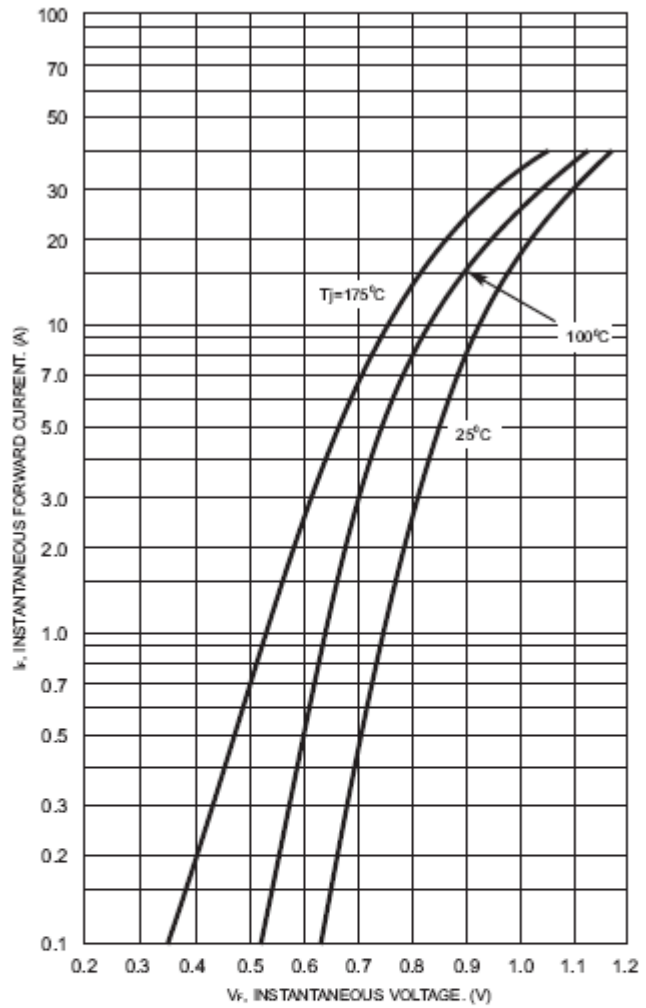

FIG.4- TYPICAL CAPACITANCE, PER LEG

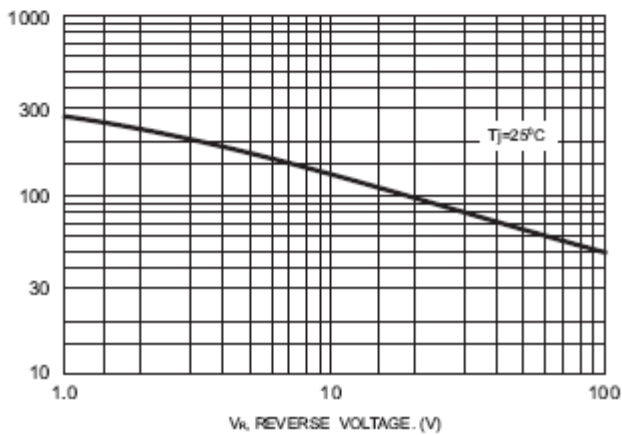
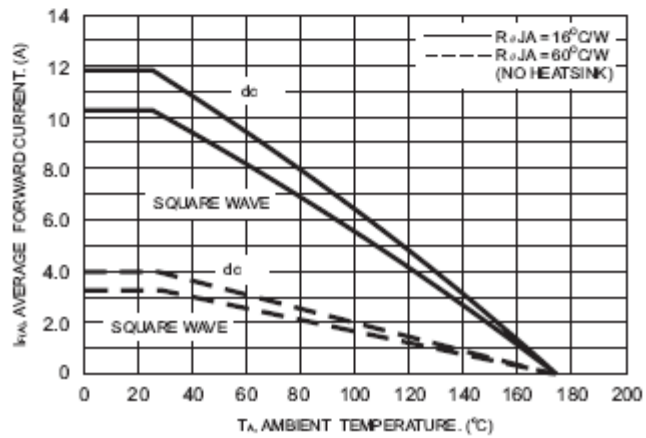







FIG.5- CURRENT DERATING, AMBIENT, PER LEG



6. Packing Specification

	
<p>1) Tube : 50units</p>	<p>2) Inner Box: 20 tube(1000units)</p>
	
<p>3) Outer Box: 10 inner box (10,000units)</p>	

7. DESCRIPTION of BOX LABEL

	<p>TYPE: Q'TY: P/O NO: LOT NO:</p>
<p>1) Inner Box Label</p>	<p>2) Inner Box Label</p>
	<p>TYPE: Q'TY: P/O NO:</p>
<p>3) Outer Box Label</p>	<p>4) Outer Box Label</p>