



MUR2020CT  
MURB2020CT  
MURB2020CT-1

Ultrafast Rectifier

**Features**

- Ultrafast Recovery Time
- Low Forward Voltage Drop
- Low Leakage Current
- 175°C Operating Junction Temperature

$t_{rr} = 25ns$
$I_{F(AV)} = 20Amp$
$V_R = 200V$

**Description/ Applications**

International Rectifier's MUR.. series are the state of the art Ultra fast recovery rectifiers specifically designed with optimized performance of forward voltage drop and ultra fast recovery time. The planar structure and the platinum doped life time control, guarantee the best overall performance, ruggedness and reliability characteristics. These devices are intended for use in the output rectification stage of SMPS, UPS, DC-DC converters as well as free-wheeling diode in low voltage inverters and chopper motor drives. Their extremely optimized stored charge and low recovery current minimize the switching losses and reduce over dissipation in the switching element and snubbers.

**Absolute Maximum Ratings**

Parameters	Max	Units
$V_{RRM}$ Peak Repetitive Peak Reverse Voltage	200	V
$I_{F(AV)}$ Average Rectified Forward Current	10	A
Total Device, (Rated $V_R$ ), $T_C = 145^\circ C$	20	
$I_{FSM}$ Non Repetitive Peak Surge Current	100	Per Leg
$I_{FM}$ Peak Repetitive Forward Current	20	
(Rated $V_R$ , Square wave, 20 KHz), $T_C = 145^\circ C$		
$T_J, T_{STG}$ Operating Junction and Storage Temperatures	-65 to 175	$^\circ C$

Case Styles		
<p>MUR2020CT</p>  <p>TO-220AB</p>	<p>MURB2020CT</p>  <p>D<sup>2</sup>PAK</p>	<p>MURB2020CT-1</p>  <p>TO-262</p>

**Electrical Characteristics @ T<sub>J</sub> = 25°C (unless otherwise specified)**

Parameters	Min	Typ	Max	Units	Test Conditions
V <sub>BR</sub> , V <sub>r</sub> Breakdown Voltage, Blocking Voltage	200	-	-	V	I <sub>R</sub> = 100μA
V <sub>F</sub> Forward Voltage	-	-	0.85	V	I <sub>F</sub> = 8A, T <sub>J</sub> = 125°C
	-	-	1.15	V	I <sub>F</sub> = 16A, T <sub>J</sub> = 25°C
	-	-	1.05	V	I <sub>F</sub> = 16A, T <sub>J</sub> = 125°C
I <sub>R</sub> Reverse Leakage Current	-	-	15	μA	V <sub>R</sub> = V <sub>R</sub> Rated
	-	-	250	μA	T <sub>J</sub> = 150°C, V <sub>R</sub> = V <sub>R</sub> Rated
C <sub>T</sub> Junction Capacitance	-	55	-	pF	V <sub>R</sub> = 200V
L <sub>S</sub> Series Inductance	-	8.0	-	nH	Measured lead to lead 5mm from package body

**Dynamic Recovery Characteristics @ T<sub>J</sub> = 25°C (unless otherwise specified)**

Parameters	Min	Typ	Max	Units	Test Conditions	
t <sub>rr</sub> Reverse Recovery Time	-	-	35	ns	I <sub>F</sub> = 1.0A, di <sub>F</sub> /dt = 50A/μs, V <sub>R</sub> = 30V	
	-	-	25		I <sub>F</sub> = 0.5A, I <sub>R</sub> = 1.0A, I <sub>REC</sub> = 0.25A	
	-	21	-	A	T <sub>J</sub> = 25°C	
	-	35	-		T <sub>J</sub> = 125°C	
I <sub>RRM</sub> Peak Recovery Current	-	1.9	-	T <sub>J</sub> = 25°C	I <sub>F</sub> = 10A V <sub>R</sub> = 160V di <sub>F</sub> /dt = 200A/μs	
	-	4.8	-	T <sub>J</sub> = 125°C		
Q <sub>rr</sub> Reverse Recovery Charge	-	25	-	nC		T <sub>J</sub> = 25°C
	-	78	-			T <sub>J</sub> = 125°C

**Thermal - Mechanical Characteristics**

Parameters	Min	Typ	Max	Units
T <sub>J</sub> Max. Junction Temperature Range	-	-	- 65 to 175	°C
T <sub>Stg</sub> Max. Storage Temperature Range	-	-	- 65 to 175	
R <sub>thJC</sub> Thermal Resistance, Junction to Case Per Leg	-	-	2.5	°C/W
R <sub>thJA</sub> Thermal Resistance, Junction to Ambient Per Leg	-	-	50	
R <sub>thCS</sub> <sup>①</sup> Thermal Resistance, Case to Heatsink	-	0.5	-	
Wt Weight	-	2.0	-	g
	-	0.07	-	(oz)
Mounting Torque	6.0	-	12	Kg-cm
	5.0	-	10	lbf.in

① Mounting Surface, Flat, Smooth and Greased

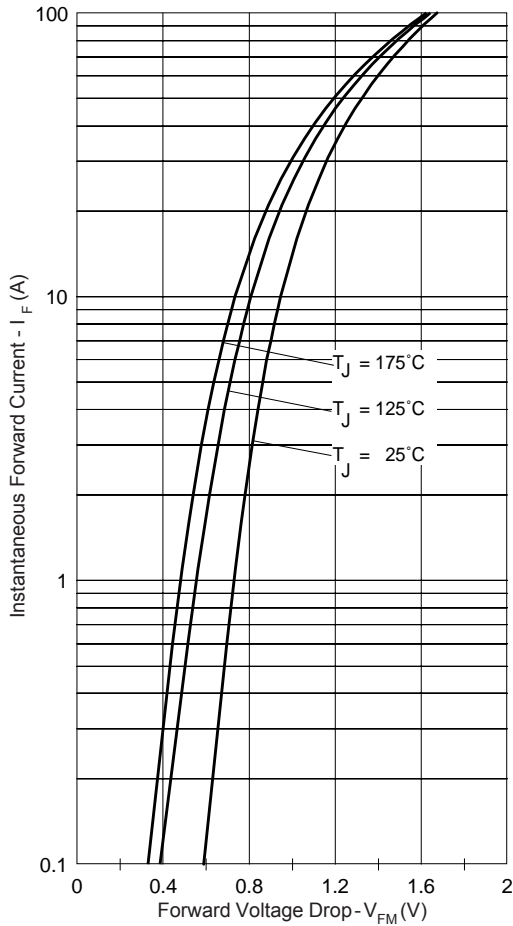

Fig. 1 - Typical Forward Voltage Drop Characteristics

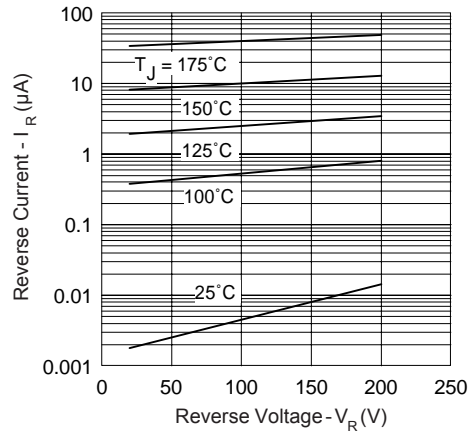

Fig. 2 - Typical Values Of Reverse Current Vs. Reverse Voltage

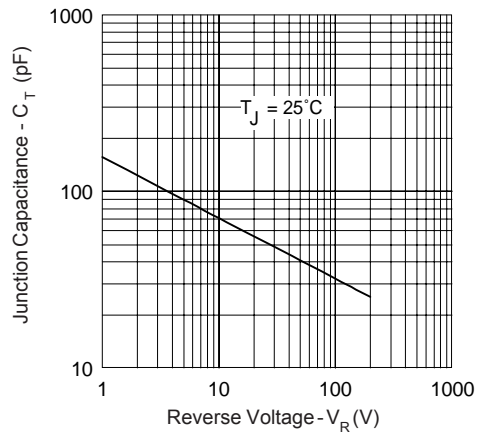

Fig. 3 - Typical Junction Capacitance Vs. Reverse Voltage

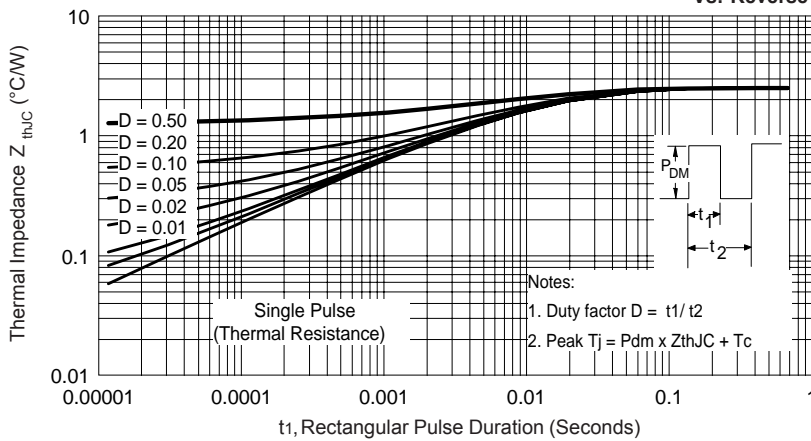
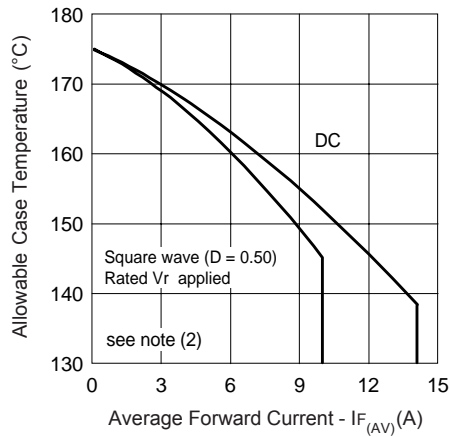
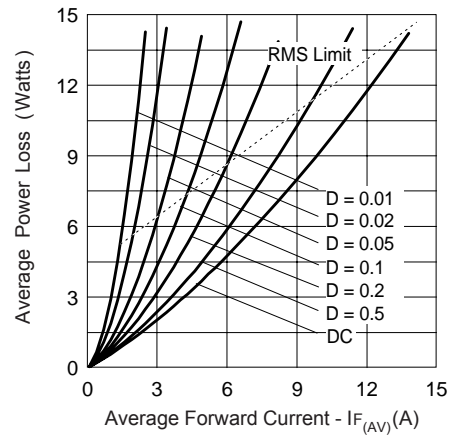

Fig. 4 - Max. Thermal Impedance  $Z_{thJC}$  Characteristics



**Fig. 5 - Max. Allowable Case Temperature Vs. Average Forward Current**



**Fig. 6 - Forward Power Loss Characteristics**

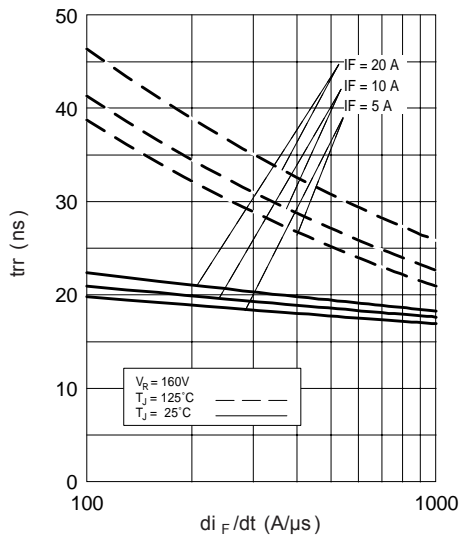

**Fig. 7 - Typical Reverse Recovery vs. di<sub>F</sub>/dt**

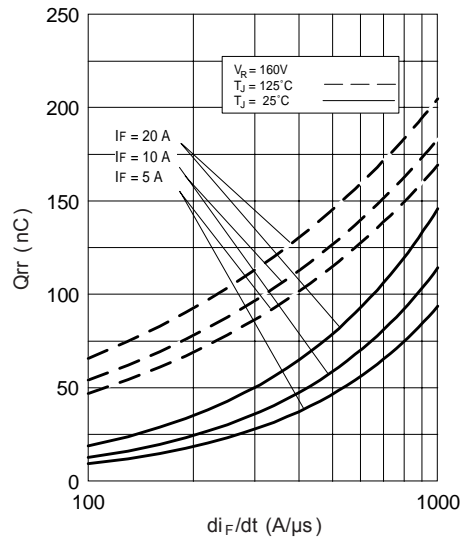

**Fig. 8 - Typical Stored Charge vs. di<sub>F</sub>/dt**

(2) Formula used:  $T_C = T_J - (P_d + P_{d_{REV}}) \times R_{thJC}$ ;  
 $P_d = \text{Forward Power Loss} = I_{F(AV)} \times V_{FM} @ (I_{F(AV)} / D)$  (see Fig. 6);  
 $P_{d_{REV}} = \text{Inverse Power Loss} = V_{R1} \times I_R (1 - D)$ ;  $I_R @ V_{R1} = \text{rated } V_R$

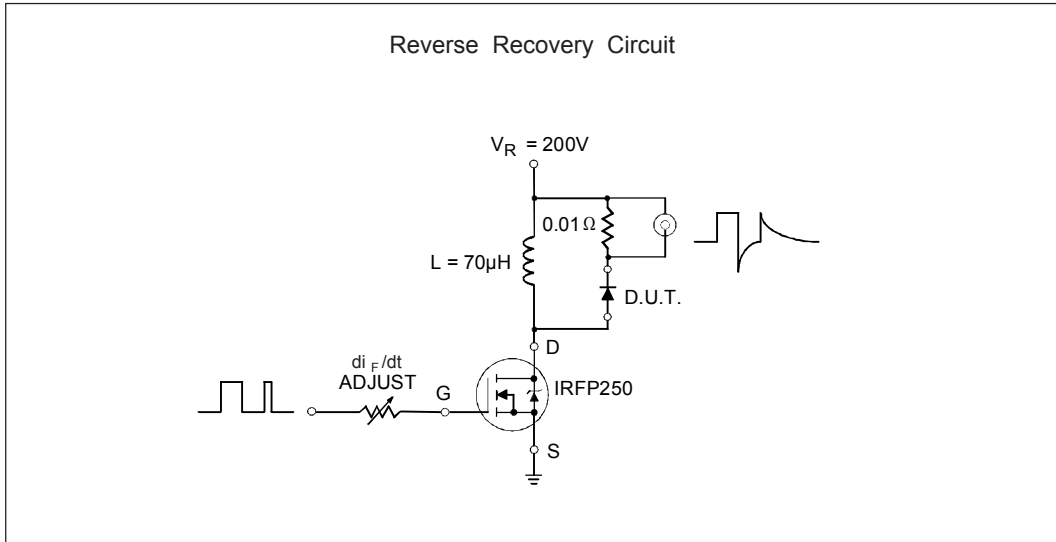

Fig. 9- Reverse Recovery Parameter Test Circuit

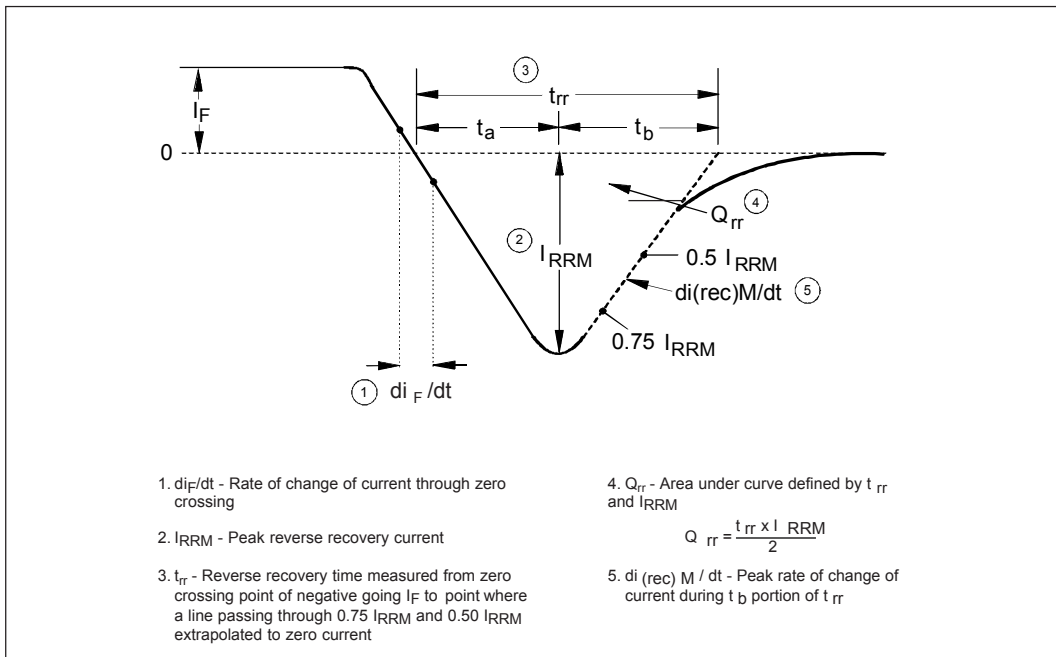
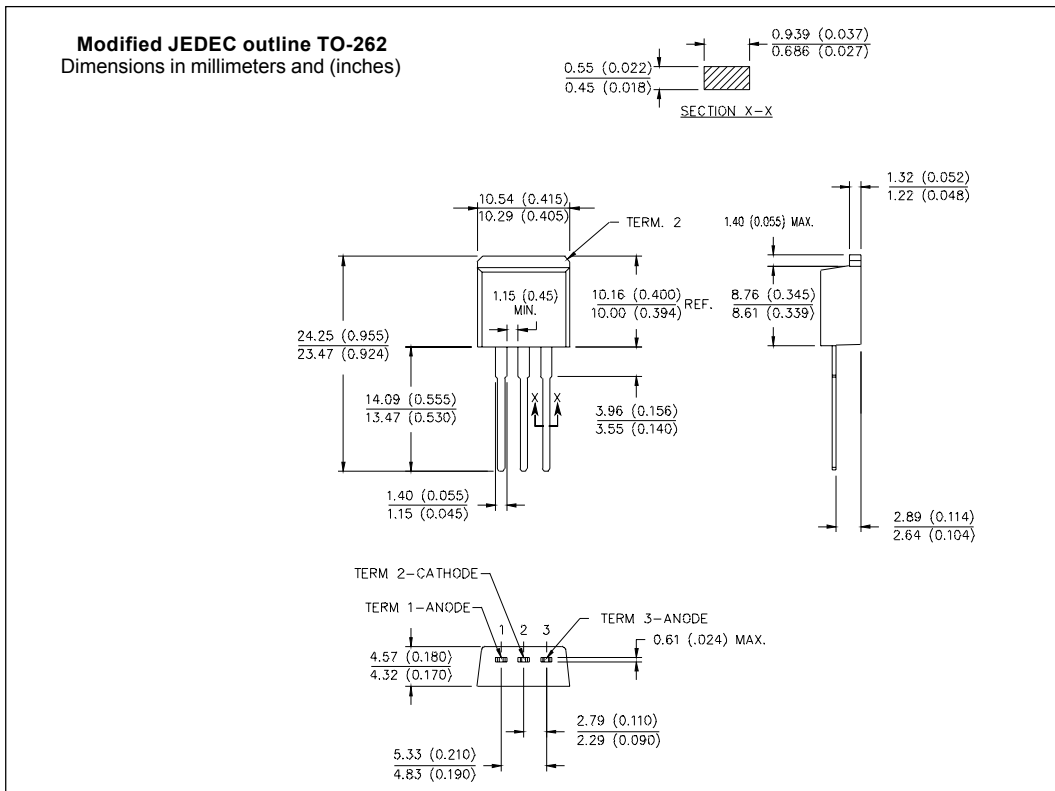
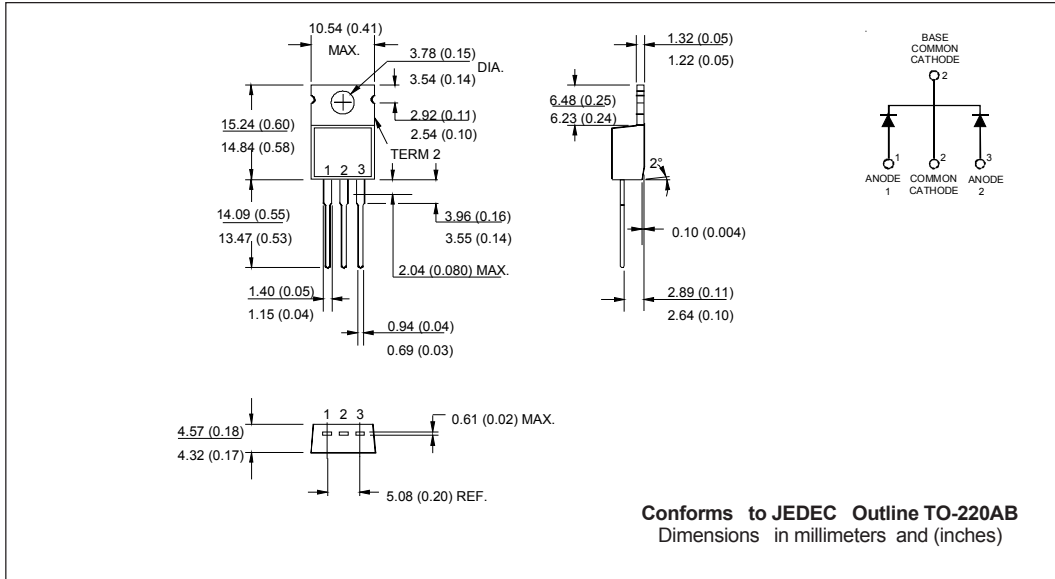
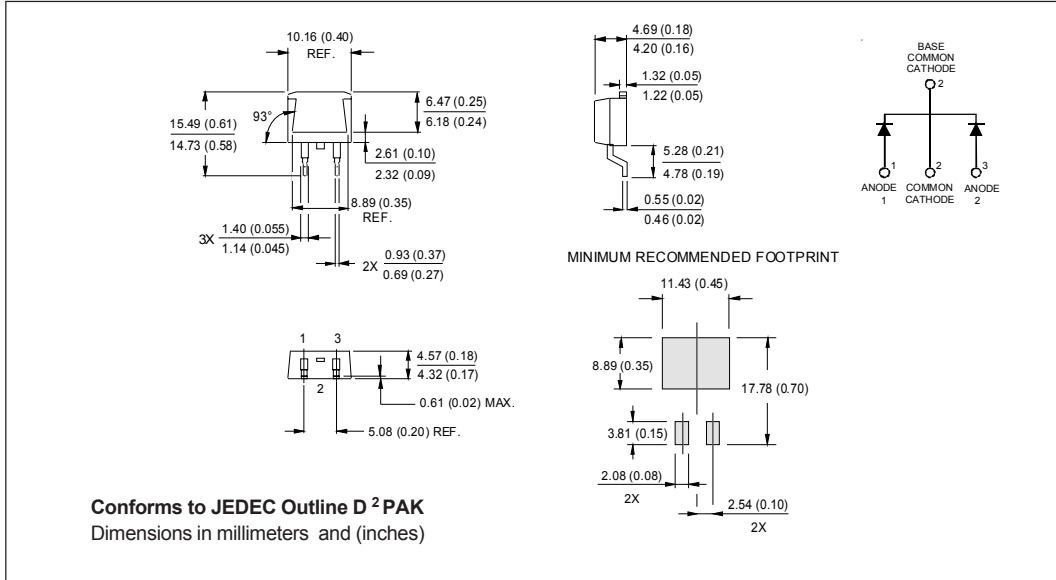

Fig. 10 - Reverse Recovery Waveform and Definitions

Outline Table



Outline Table



Ordering Information Table

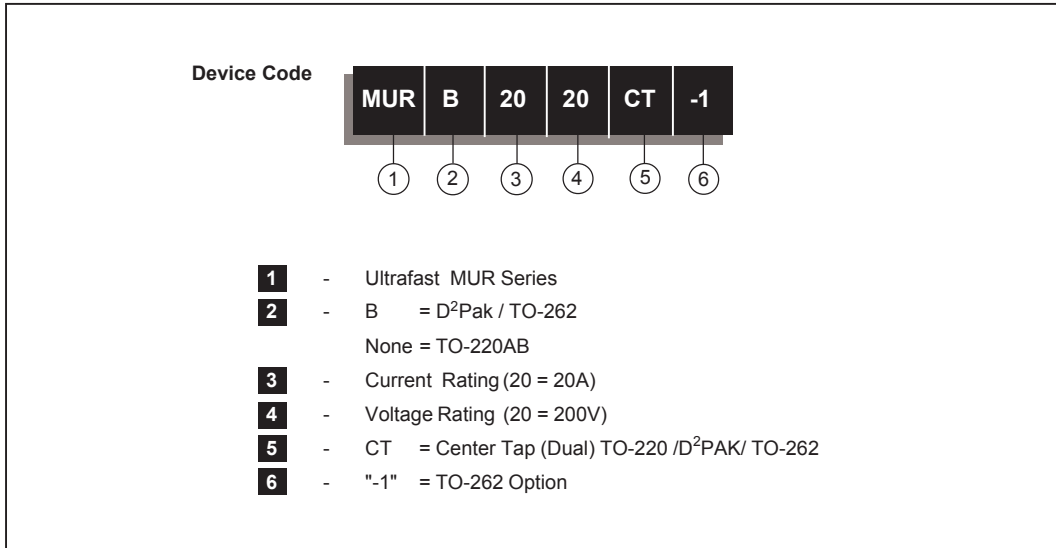

```

MUR2020
*****
* SPICE Model Diode *
*****
.SUBCKT MUR2020 ANO CAT
D1 ANO 1 CAT
*Define diode model
.MODEL DMOD D (IS=1.04703N N=1.44364 BV=280 IBV=100P RS=7.57994M
+ CJO=218.618P VJ=700M M=399.212M EG=1.11 RL=17.4782G)

*****

.ENDS MUR2020

Thermal Model Subcircuit
.SUBCKT MUR2020 5 1

CTHERM1 5 4 3.93E+01
CTHERM2 4 3 2.67E+02
CTHERM3 3 2 5.20E+02
CTHERM4 2 1 1.66E+03

RTHERM1 5 4 1.12E+00
RTHERM2 4 3 1.04E+00
RTHERM1 3 2 1.57E-01
RTHERM1 2 1 1.89E-01

.ENDS MUR2020
    
```

Data and specifications subject to change without notice.  
 This product has been designed and qualified for Industrial Level.  
 Qualification Standards can be found on IR's Web site.





## Notice

The products described herein were acquired by Vishay Intertechnology, Inc., as part of its acquisition of International Rectifier's Power Control Systems (PCS) business, which closed in April 2007. Specifications of the products displayed herein are pending review by Vishay and are subject to the terms and conditions shown below.

Specifications of the products displayed herein are subject to change without notice. Vishay Intertechnology, Inc., or anyone on its behalf, assumes no responsibility or liability for any errors or inaccuracies.

Information contained herein is intended to provide a product description only. No license, express or implied, by estoppel or otherwise, to any intellectual property rights is granted by this document. Except as provided in Vishay's terms and conditions of sale for such products, Vishay assumes no liability whatsoever, and disclaims any express or implied warranty, relating to sale and/or use of Vishay products including liability or warranties relating to fitness for a particular purpose, merchantability, or infringement of any patent, copyright, or other intellectual property right.

The products shown herein are not designed for use in medical, life-saving, or life-sustaining applications. Customers using or selling these products for use in such applications do so at their own risk and agree to fully indemnify Vishay for any damages resulting from such improper use or sale.

International Rectifier®, IR®, the IR logo, HEXFET®, HEXSense®, HEXDIP®, DOL®, INTERO®, and POWIRTRAIN® are registered trademarks of International Rectifier Corporation in the U.S. and other countries. All other product names noted herein may be trademarks of their respective owners.