



ULTRA FAST RECTIFIERS

MUR820D-MUR860D

FEATURES

- Low cost.
- Diffused junction.
- Glass passivated junction.
- Low forward voltage drop.
- High current capability.
- Easily cleaned with Alcohol, Isopropanol and similar solvents.
- The plastic material carries U/L recognition 94V-0.



Lead-free

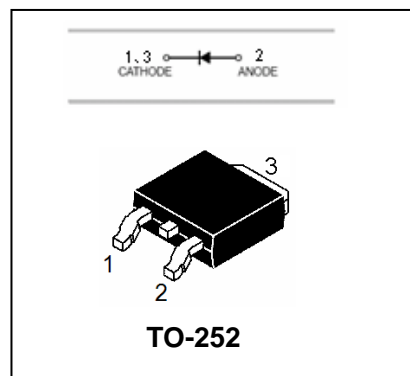

MAXIMUM RATING operating temperature range applies unless otherwise specified

Symbol	Parameter	MUR 820D	MUR 840D	MUR 860D	Unit
V_{RRM}	Recurrent Peak Reverse Voltage	200	400	600	V
V_{RMS}	RMS Voltage	140	280	420	V
V_{DC}	DC Blocking Voltage	200	400	600	V
$I_{F(AV)}$	Average Forward Rectified Current @ $T_A=100^\circ\text{C}$	8.0			A
I_{FSM}	Peak Forward Surge Current 8.3ms Single Half Sine-wave Superimosed on Rated Load	100			A
$R_{\theta jc}$	Typical thermal resistance junction to case	3.0	2.0		$^\circ\text{C}/\text{W}$
T_j T_{stg}	Operating Junction and Storage Temperature Range	-65 to +175			$^\circ\text{C}$

ELECTRICAL CHARACTERISTICS @ $T_a=25^\circ\text{C}$ unless otherwise specified

Parameter	Symbol	Test conditions	MAX			UNIT
			MUR 820D	MUR 840D	MUR 860D	
Forward Voltage	V_F (Note1)	$I_F=8\text{A}, T_A=25^\circ\text{C}$	0.975	1.3	1.5	V
		$I_F=8\text{A}, T_A=125^\circ\text{C}$	0.895	1.0	1.2	
Reverse Current	I_R	$V_R=V_{RRM}, T_A=25^\circ\text{C}$	5.0	10		μA
		$V_R=V_{RRM}, T_A=150^\circ\text{C}$	250	500		
Reverse Recover Time	t_{rr}	$I_F=0.5\text{A}, I_R=1\text{A}, I_{rr}=0.25\text{A}$	25	50		ns

Note: 1. Pulse test: pulse width=300us, duty cycle $\leq 2.0\%$.



ULTRA FAST RECTIFIERS

MUR820D-MUR860D

TYPICAL CHARACTERISTICS @ Ta=25°C unless otherwise specified

FIG.1 –TYPICAL FORWARD CHARACTERISTIC

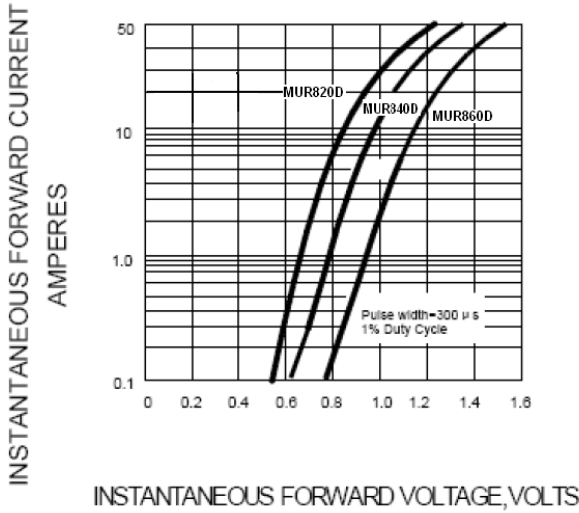

FIG.2 –TYPICAL REVERSE CHARACTERISTICS

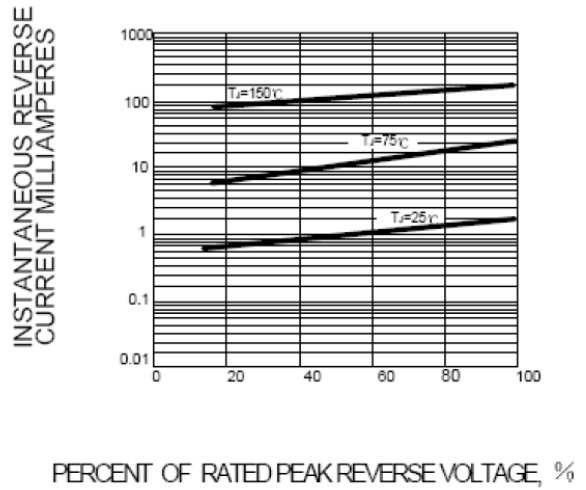

FIG.3 – PEAK FORWARD SURGE CURRENT

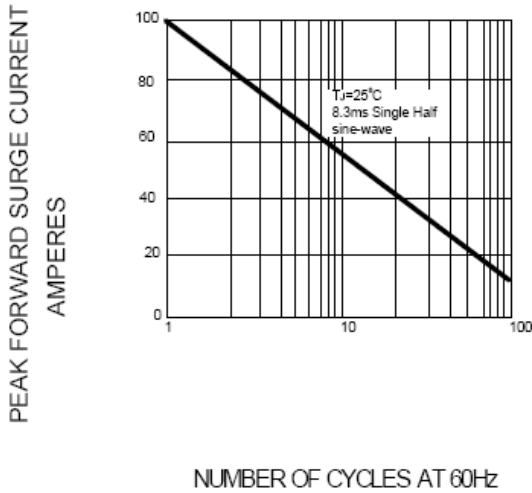
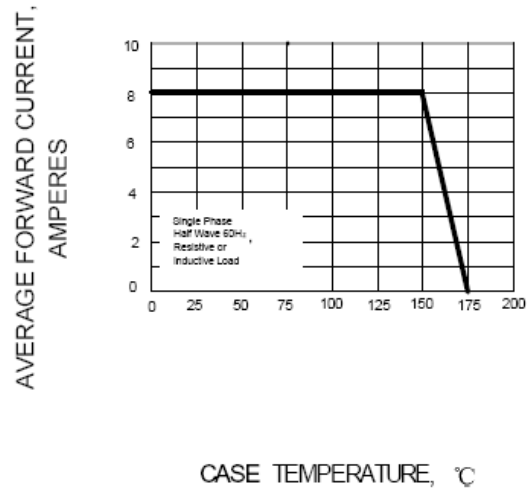

FIG.4 – FORWARD DERATING CURVE





ULTRA FAST RECTIFIERS

MUR820D-MUR860D

PACKAGE OUTLINE

Plastic surface mounted package

TO-252

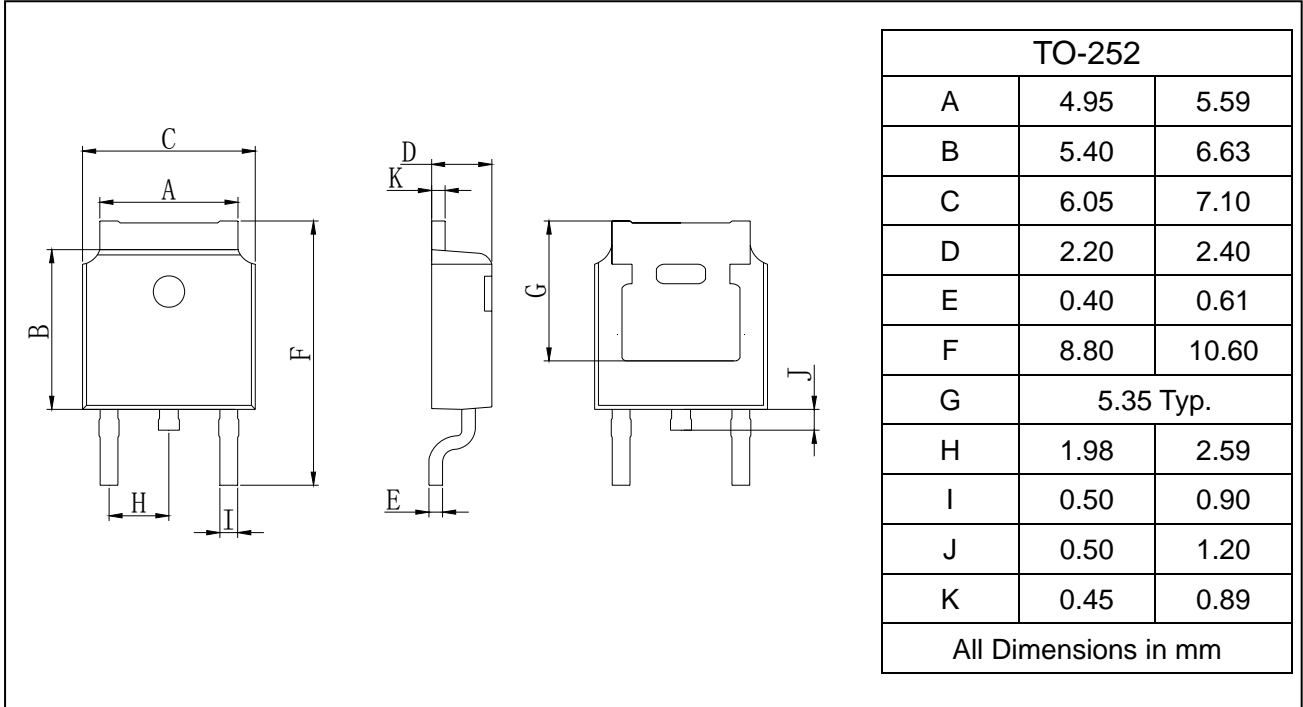

SOLDERING FOOTPRINT

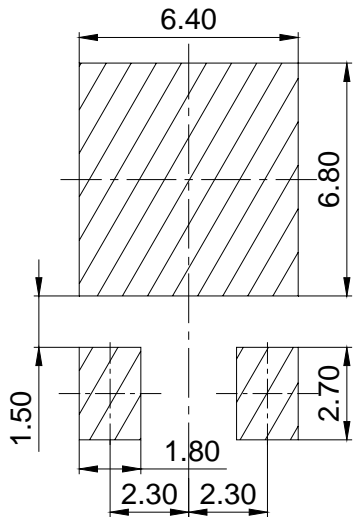

Unit:mm



ULTRA FAST RECTIFIERS

MUR820D-MUR860D

PACKAGE INFORMATION

Device	Package	Shipping
MUR820D-MUR860D	TO-252	80PCS/Tube
		2500PCS/Tape&Reel