

Features

- FRED (Planar) wafer construction
- Ultrafast recovery time
- Low forward voltage drop, low power loss
- High efficiency
- Plastic package has underwriters Laboratory Flammability Classification 94V-0

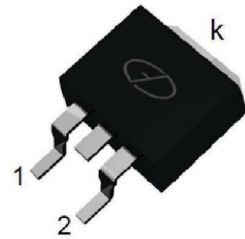

Package: TO-263 (D²PAK)

Mechanical Data

- Case: Epoxy, molded
- Weight: 1.4 grams (approximately)
- Finish: all external surfaces corrosion resistant and terminal leads readily solderable
- Lead temperature for soldering purposes: 260°C Max. for 10 sec
- 50 units per plastic tube or 800 units per reel

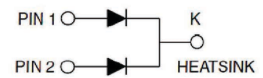

Schematic Diagram

Maximum Ratings & Electrical Characteristics

(T_A=25°C unless otherwise noted)

Parameter	Test Conditions		Symbol	Value	Unit
Maximum Repetitive Peak Reverse Voltage			V _{RRM}	400	V
Working Peak Reverse Voltage			V _{RWM}	400	V
Maximum DC Blocking Voltage			V _{DC}	400	V
Maximum Average Forward Rectified Current @ T _c =105°C	Total Device		I _{F(AV)}	10	A
	Per Diode			5	
Peak Forward Surge Current 8.3ms Single Half Sine-wave Superimposed on Rated Load per Diode			I _{FSM}	90	A
Voltage Rate of Change (rated V _R)			DV/dt	10000	V/μs
Operating Junction Temperature Range			T _J	- 55 to+150	°C
Storage Temperature Range			T _{STG}	- 55 to+150	°C
Maximum Reverse Recover Time (I _F =0.5A, I _R =1.0A, I _{rec} =0.25A)			T _{rr}	50	ns
Maximum Instantaneous Forward Voltage per Leg	I _F =5A	T _C =25°C	V _F	1.30	V
	I _F =5A	T _C =125°C		1.20	
Maximum Reverse Current per Leg at Working Peak Reverse Voltage		T _J =25°C	I _R	10	μA
		T _J =100°C		500	μA

Thermal Characteristics T_A=25°C unless otherwise noted

Symbol	Parameter	Typ.	Unit
R _{θJC}	Thermal Resistance, Junction to Case per Leg	2.0	°C/W
R _{θJA}	Thermal Resistance, Junction to Ambient per Leg	62.5	°C/W

Note: Pulse test:300us pulse width, duty cycle=2%

Ratings and Characteristics Curves ($T_A = 25^\circ\text{C}$ unless otherwise noted)

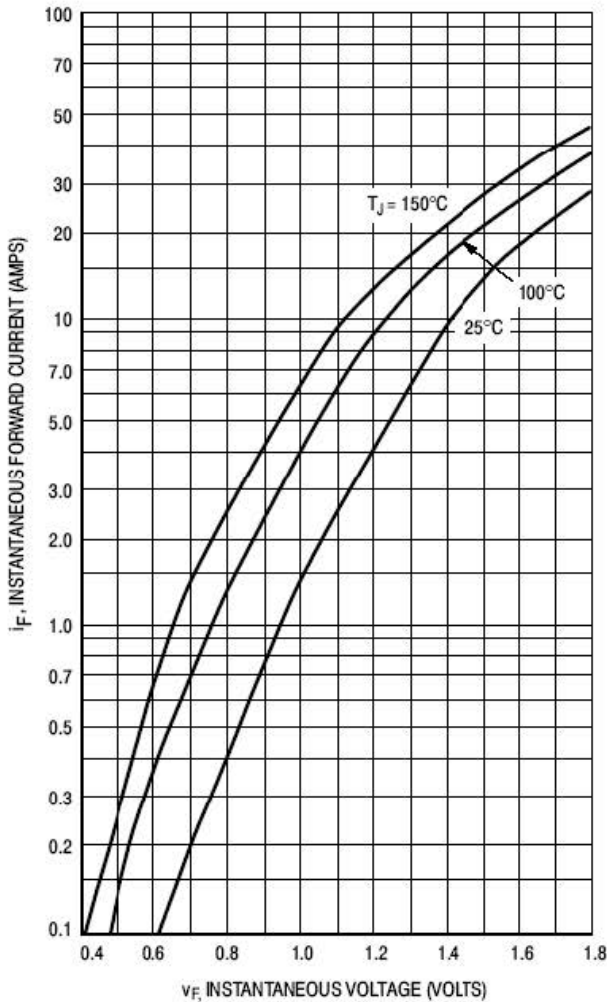

Figure 1. Typical Forward Voltage, Per Leg

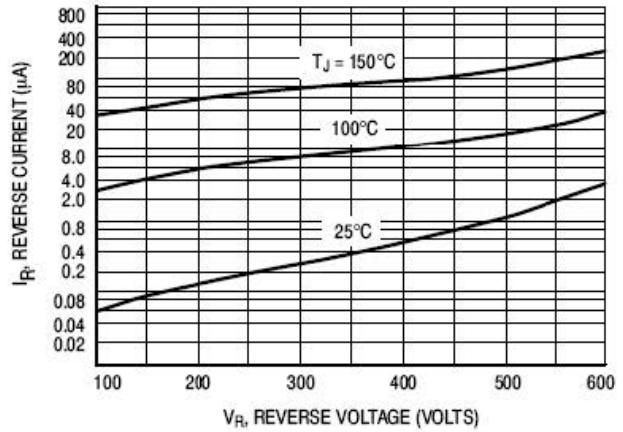

Figure 2. Typical Reverse Current, Per Leg*

* The curves shown are typical for the highest voltage device in the voltage grouping. Typical reverse current for lower voltage selections can be estimated from these same curves if V_R is sufficiently below rated V_R .

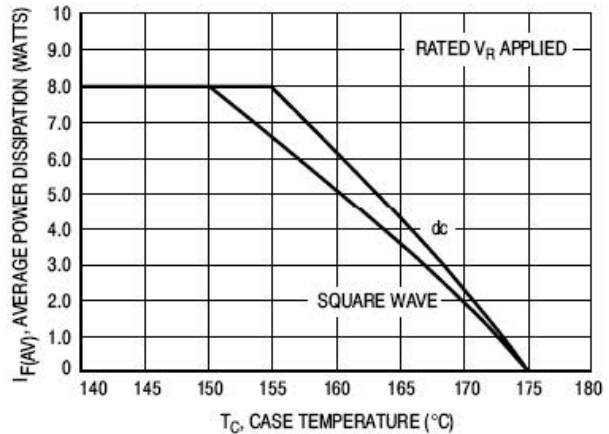

Figure 3. Current Derating, Case, Per Leg

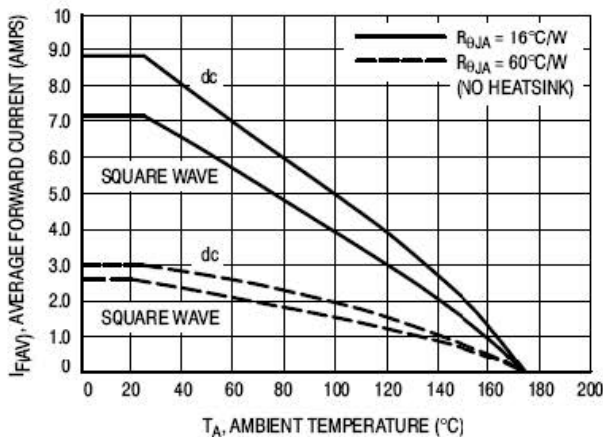

Figure 4. Current Derating, Ambient, Per Leg

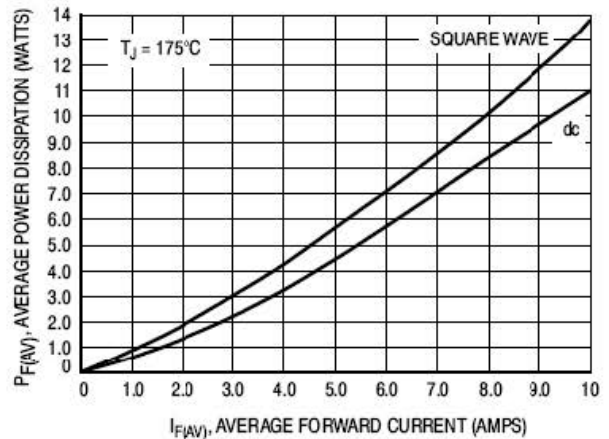
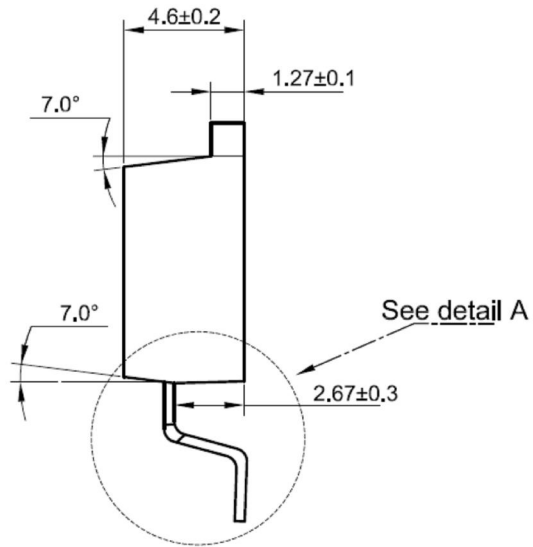
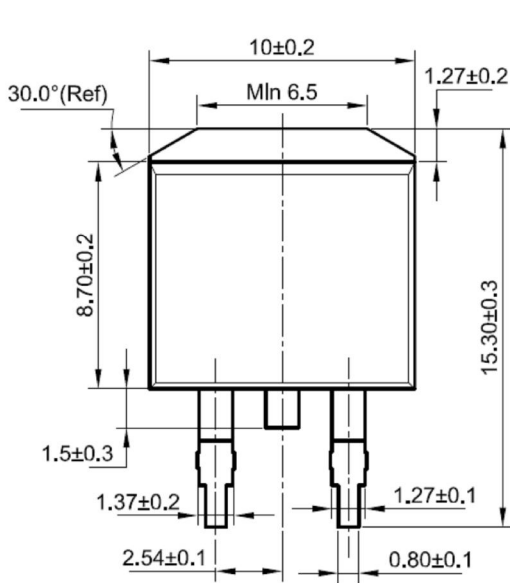

Figure 5. Power Dissipation, Per Leg

Package Outline Dimensions

in millimeters

TO-263 (D²PAK)



Detail A

