

# MURJ1220CT

Rev.E Mar.-2016

## 描述 / Descriptions

TO-220S 塑封封装 超快恢复二极管。 Ultrafast Recovery Diode in a TO-220S Plastic Package.

## 特征 / Features

采用硅外延工艺生产的超快恢复二极管，具有较低的反向漏电和高可靠性。

Silicon epitaxial process to produce ultrafast recovery diode with low reverse leakage current and high reliability.

## 用途 / Applications

用于高频、低压、大电流整流二极管，续流二极管，保护二极管。

For use in low voltage, high frequency inverters, free wheeling, and polarity protection applications.

## 内部等效电路 / Equivalent Circuit

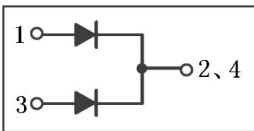

## 引脚排列 / Pinning

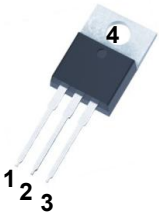

PIN1 : Anode

PIN 2 : Cathode

PIN 3 : Anode

PIN 4 : NC

## 放大及印章代码 / $h_{FE}$ Classifications & Marking

见印章说明。 See Marking Instructions

**极限参数 / Absolute Maximum Ratings(Ta=25°C)**

参数 Parameter	符号 Symbol	数值 Rating	单位 Unit
Peak Repetitive Reverse Voltage	$V_{RRM}$	200	V
RMS Voltage	$V_{RMS}$	140	V
DC Blocking Voltage	$V_{DC}$	200	V
Average Rectified Forward Current	$I_F$	2×6	A
Non Repetitive Peak Surge Current	$I_{FSM}$	100	A
Thermal Resistance Junction to Case	$R_{\theta JC}$	2.9	°C/W
Storage Temperature Range	$T_j, T_{stg}$	-55~150	°C

**电性能参数 / Electrical Characteristics(Ta=25°C)**

参数 Parameter	符号 Symbol	测试条件 Test Conditions	最小值 Min	典型值 Typ	最大值 Max	单位 Unit
Forward Voltage	$V_F$	$I_F=2.0A(T_C=25^\circ C)$		0.82		V
		$I_F=2.0A(T_C=125^\circ C)$		0.68		V
		$I_F=6.0A(T_C=25^\circ C)$		0.92	1.0	V
		$I_F=6.0A(T_C=125^\circ C)$		0.82	0.9	V
Instantaneous Reverse Current	$I_R$	$V_R=200V(T_a=25^\circ C)$			10	μA
		$V_R=200V(T_a=125^\circ C)$			150	μA
Reverse Recovery Time	$t_{rr}$	$I_F=0.5A \quad I_R=1.0A$ $I_{RR}=0.25A$			35	ns

注/Notes:

1. 使用极短的测试时间,以尽量减少自热效应。/Short duration pulse test used to minimize self-heating effect.
2. 除非特别注明,数值为一个芯片的参数。/ Unless otherwise noted, values for the parameters of a single chip

**电参数曲线图 / Electrical Characteristic Curve**

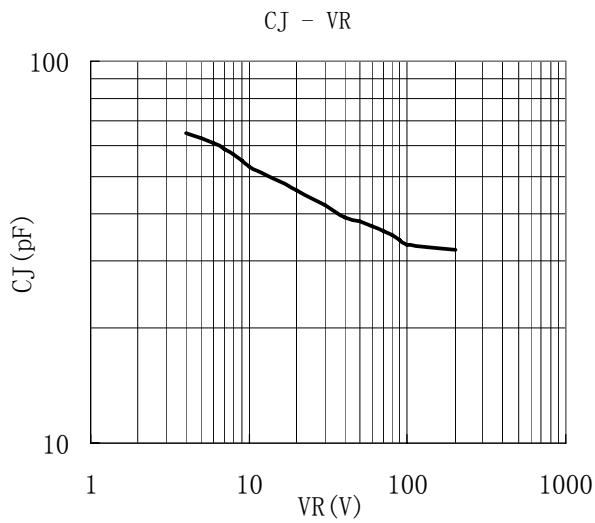
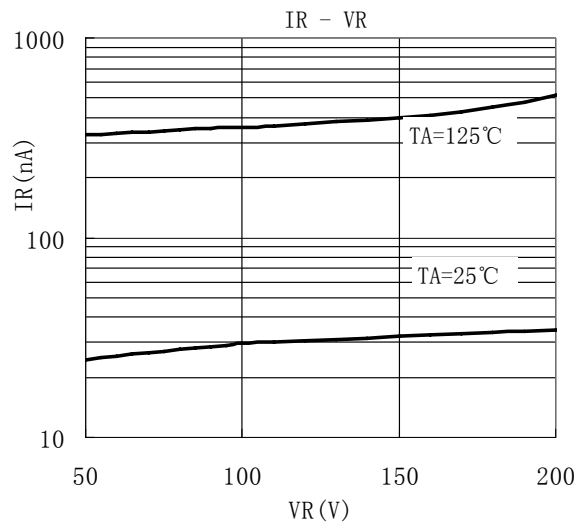
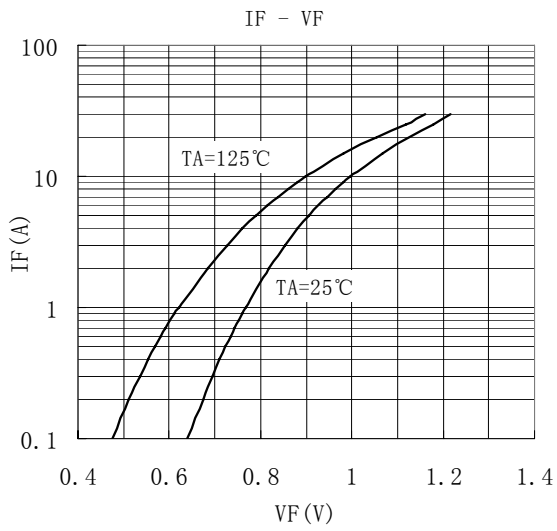
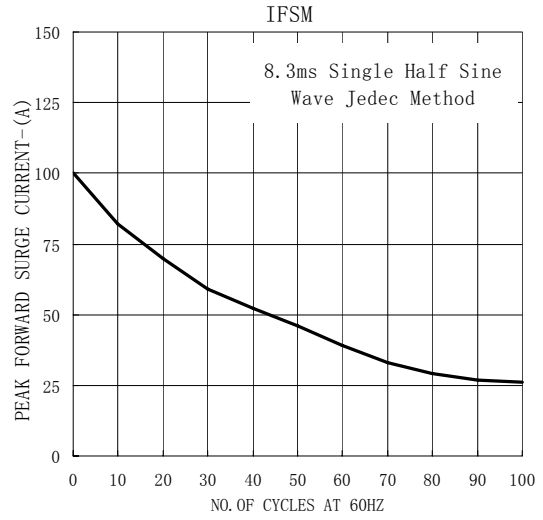
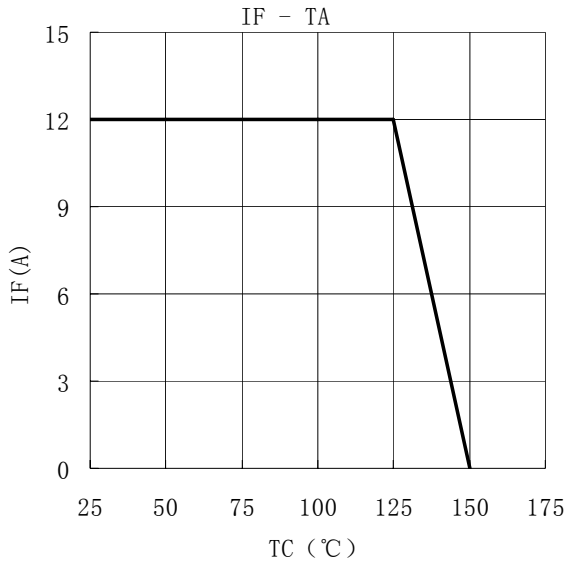

外形尺寸图 / Package Dimensions

TO-220S

Unit: mm

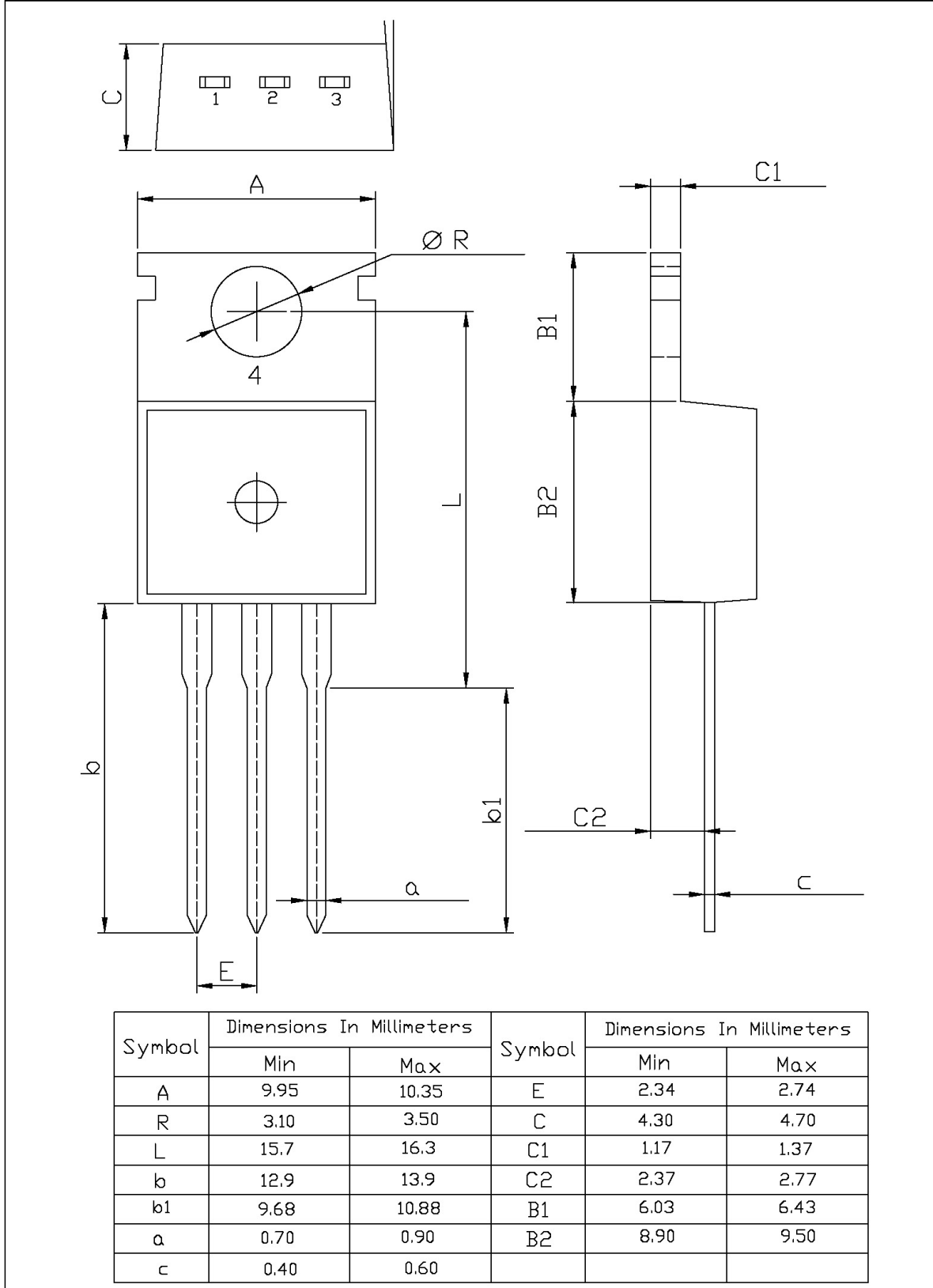

## 印章说明 / Marking Instructions

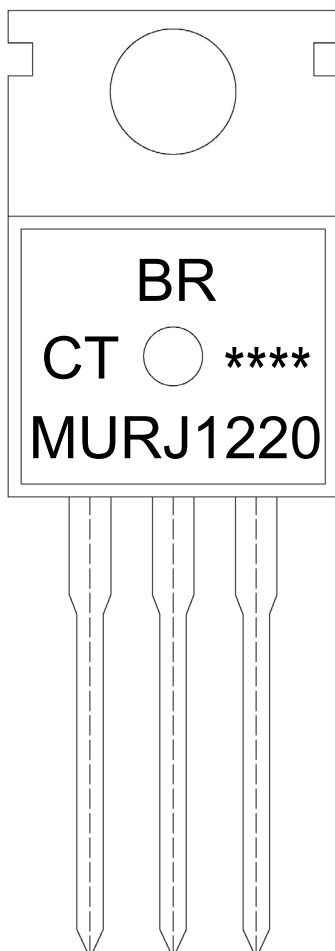

说明：

BR： 为公司代码

MURJ1220： 为型号代码

CT： 为内部结构

\*\*\*\*： 为生产批号代码，随生产批号变化。

Note:

BR: Company Code

MURJ1220 : Product Type.

CT: Internal Structure

\*\*\*\*: Lot No. Code, code change with Lot No.

**波峰焊温度曲线图(无铅) / Temperature Profile for Dip Soldering(Pb-Free)**



说明：

- 1、预热温度 25 ~ 150°C，时间 60 ~ 90sec;
- 2、峰值温度 255±5°C，时间持续为 5±0.5sec;
- 3、焊接制程冷却速度为 2 ~ 10°C/sec.

Note:

- 1.Preheating:25~150°C, Time:60~90sec.
- 2.Peak Temp.:255±5°C, Duration:5±0.5sec.
3. Cooling Speed: 2~10°C/sec.

**耐焊接热试验条件 / Resistance to Soldering Heat Test Conditions**

温度：270±5°C

时间：10±1 sec.

Temp.:270±5°C

Time:10±1 sec

**包装规格 / Packaging SPEC.**

套管包装 / TUBE

Package Type 封装形式	Units 包装数量					Dimension 包装尺寸 (unit: mm <sup>3</sup> )		
	Units/Tube 只/套管	Tubes/Inner Box 套管/盒	Units/Inner Box 只/盒	Inner Boxes/Outer Box 盒/箱	Units/Outer Box 只/箱	Tube 套管	Inner Box 盒	Outer Box 箱
TO-220S	50	20	1000	5	5000	532×31.4×5.5	555×164×50	575×290×180

**使用说明 / Notices**