



MUSES05

High-Quality Sound, J-FET Input, Single Operational Amplifier for Premium Audio



FEATURES

- ($V^+ / V^- = \pm 15V$, Typical value, $T_a = 25^\circ C$)
- High-quality Sound
 - Low Input Bias Current 5pA
 - Low Noise 7.5nV/ \sqrt{Hz} at $f=1kHz$
 - Ultralow Distortion 0.00003% at $f=1kHz$
 - High Slew Rate 40V/ μs
 - Gain Bandwidth Product 12MHz
 - Operating Voltage $\pm 3.5V$ to $\pm 18V$
 - Operating Current 5.8mA
 - J-FET Input
 - Bipolar Technology
 - Package Outline DFN12-CA8 (ESON12-CA8) (OFC lead-frame)

DESCRIPTION

The MUSES05 is a high-quality sound J-FET input single operational amplifier for premium audio equipment. The MUSES05 uses advanced circuit design and special material and assembly technology to high-quality sound. The MUSES05 features high-quality sound, low input bias current, low noise, ultralow distortion and high slew rate, and it is suitable for I/V converters, preamplifiers, active filters, headphone amplifiers, and line amplifiers.



The MUSES logo is a trademark or registered trademark of Nisshinbo Micro Devices Inc.

APPLICATIONS

- Home Audio
- Professional Audio
- Portable Audio
- Car Audio

THD and Slew Rate

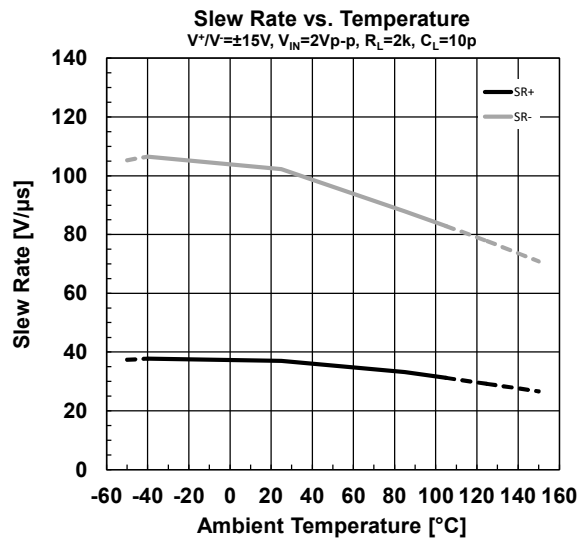
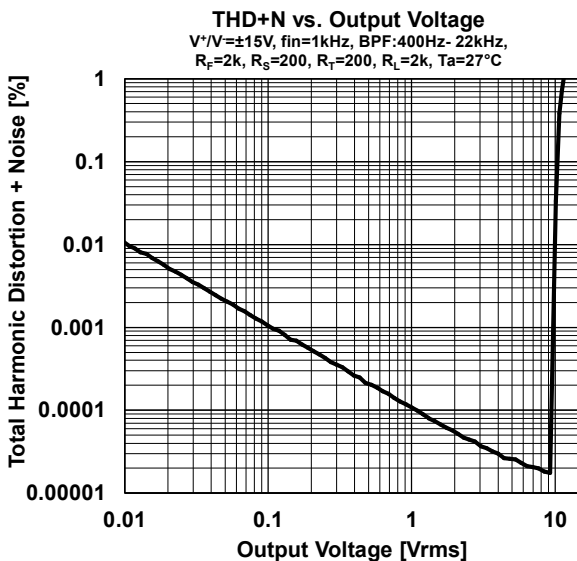

■ **PRODUCT NAME INFORMATION**

MUSES05 (aaa)

Description of configuration

Suffix	Item	Description
aaa	Packing	Refer to the packing specifications.

■ **ORDER INFORMATION**

Product Name	Package	RoHS	Halogen-Free	Terminal Finish	Marking	Weight (mg)	MOQ (pcs)
MUSES05 (TE3)	DFN12-CA8 (ESON12-CA8)	Yes	Yes	Sn2Bi	05	62	100

■ **PIN DESCRIPTIONS**

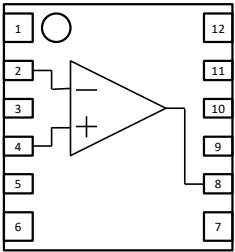
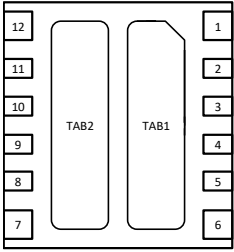
Product Name	MUSES05	
Package	DFN12-CA8 (ESON12-CA8)	
Pin Configuration	(TOP View)	(Bottom View)
		

Pin No.	Pin Name	I/O	Description
1	NC	-	Not connected
2	-INPUT	I	Inverting input
3	NC	-	Not connected (Do not connect)
4	+INPUT	I	Non-inverting input
5	NC	-	Not connected
6	V ⁻	-	Negative supply or Ground (single supply)
7	V ⁻	-	Negative supply or Ground (single supply)
8	OUTPUT	O	Output
9	NC	-	Not connected (Do not connect)
10	V ⁺	-	Positive supply
11	V ⁺	-	Positive supply
12	V ⁺	-	Positive supply
TAB1	TAB1	-	Exposed Pad Floating or connecting to V ⁻ . Floating state is recommended for TAB1 and TAB2 in terms of sound quality. Do not short circuit TAB1 and TAB2.
TAB2	TAB2	-	Exposed Pad Floating or connecting to V ⁻ . Floating state is recommended for TAB1 and TAB2 in terms of sound quality. Do not short circuit TAB1 and TAB2.

■ ABSOLUTE MAXIMUM RATINGS

Parameter	Symbol	Rating	Unit
Supply Voltage	V ⁺ / V ⁻	±19	V
Input Voltage *1	V _{IN}	±18	V
Differential Input Voltage	V _{ID}	±6.0	V
Output Peak Current	I _{OP}	250	mA
Power Dissipation (Ta = 25°C) DFN12-CA8 (ESON12-CA8)	P _D	2-Layer / 4-Layer 940 *2 / 3500 *3	mW
Storage Temperature	T _{stg}	-50 to 150	°C
Junction Temperature	T _j	150	°C

*1 Supply voltages less than ±18V, the maximum input voltage is equal to the supply voltage.

*2 2-Layer: Mounted on glass epoxy board. (76.2×114.3×1.6mm, based on JEDEC standard JESD51-3/5/7, 2Layers FR-4) Exposed Pad (TAB1/ TAB2)

*3 4-Layer: Mounted on glass epoxy board. (76.2×114.3×1.6mm, based on JEDEC standard JESD51-3/5/7, 4Layers FR-4) Exposed Pad (TAB1/ TAB2), Thermal via hole

ABSOLUTE MAXIMUM RATINGS

Electronic and mechanical stress momentarily exceeded absolute maximum ratings may cause permanent damage and may degrade the lifetime and safety for both device and system using the device in the field. The functional operation at or over these absolute maximum ratings is not assured.

■ THERMAL CHARACTERISTICS

Package	Measurement Result		Unit
	Thermal Resistance (θ _{ja})	Thermal Characterization Parameter (ψ _{jt})	
DFN12-CA8 (ESON12-CA8)	133.3 *4 / 35.6 *5	8.7 *4 / 3.9 *5	°C/W

θ_{ja} :Junction-to-Ambient Thermal Resistance

ψ_{jt}:Junction-to-Top Thermal Characterization Parameter

*4 2-Layer: Mounted on glass epoxy board. (76.2×114.3×1.6mm, based on JEDEC standard JESD51-3/5/7, 2Layers FR-4) Exposed Pad (TAB1/ TAB2)

*5 4-Layer: Mounted on glass epoxy board. (76.2×114.3×1.6mm, based on JEDEC standard JESD51-3/5/7, 4Layers FR-4) Exposed Pad (TAB1/ TAB2), Thermal via hole

■ ELECTROSTATIC DISCHARGE (ESD) PROTECTION VOLTAGE

Parameter	Conditions	Protection Voltage
HBM	C = 100 pF, R = 1.5 kΩ	±1000 V
CDM	Direct CDM	±1000 V

ELECTROSTATIC DISCHARGE RATINGS

The electrostatic discharge test is done based on JEITA ED-4701.
In the HBM method, ESD is applied using the power supply pin and GND pin as reference pins.

■ RECOMMENDED OPERATING CONDITIONS

Parameter	Symbol	Conditions	Rating	Unit
Supply Voltage	V ⁺ /V ⁻		±3.5 to ±18	V
Operating Temperature	T _{opr}		-40 to 105	°C

RECOMMENDED OPERATING CONDITIONS
<p>All of electronic equipment should be designed that the mounted semiconductor devices operate within the recommended operating conditions. The semiconductor devices cannot operate normally over the recommended operating conditions, even if when they are used over such conditions by momentary electronic noise or surge. And the semiconductor devices may receive serious damage when they continue to operate over the recommended operating conditions.</p>

■ ELECTRICAL CHARACTERISTICS

$V^+/V^-=\pm 15V$, R_L to GND, $T_a=25^\circ C$, unless otherwise specified

Parameter	Symbol	Test Conditions	Min	Typ	Max	Unit
DC CHARACTERISTICS						
Supply Current	I_{CC}	No Signal, $R_L=\infty$	-	5.8	10	mA
Input Offset Voltage	V_{IO}	$R_S=50\Omega$	-	1.0	10	mV
Input Bias Current	I_B		-	5.0	250	pA
Input Offset Current	I_{IO}		-	2.0	220	pA
Voltage Gain 1	A_{V1}	$R_L=10k\Omega$, $V_o=\pm 13V$	100	130	-	dB
Voltage Gain 2	A_{V2}	$R_L=2k\Omega$, $V_o=\pm 12.8V$	100	130	-	dB
Voltage Gain 3	A_{V3}	$R_L=600\Omega$, $V_o=\pm 12.5V$	100	130	-	dB
Common Mode Rejection Ratio	CMR	$V_{ICM}=\pm 12.5V$	75	100	-	dB
Supply Voltage Rejection Ratio	SVR	$V^+/V^-=\pm 3.5$ to $\pm 18V$	80	110	-	dB
Maximum Output Voltage 1	V_{OM1}	$R_L=10k\Omega$	± 13.0	± 14.0	-	V
Maximum Output Voltage 2	V_{OM2}	$R_L=2k\Omega$	± 12.8	± 13.8	-	V
Maximum Output Voltage 3	V_{OM3}	$R_L=600\Omega$	± 12.5	± 13.5	-	V
Input Common Mode Voltage Range	V_{ICM}	CMR $\geq 75dB$	± 12.0	± 13.0	-	V
AC CHARACTERISTICS						
Gain Bandwidth Product	GBW	$f=10kHz$	-	12	-	MHz
Unity Gain Frequency	f_T	$A_v=+100$, $R_S=100\Omega$, $R_L=2k\Omega$, $C_L=10pF$	-	13	-	MHz
Phase Margin	Φ_M	$A_v=+100$, $R_S=100\Omega$, $R_L=2k\Omega$, $C_L=10pF$	-	70	-	Deg
Input Noise Voltage1	e_n	$f=1kHz$	-	7.5	-	nV/ \sqrt{Hz}
Input Noise Voltage2	V_{NI}	$f=20-20kHz$	-	1.0	-	μV_{rms}
Total Harmonic Distortion	THD	$f=1kHz$, $A_v=+10$, $V_o=5V_{rms}$, $R_L=2k\Omega$	-	0.00003	-	%
Slew Rate	SR	$A_v=1$, $V_{IN}=2V_{p-p}$, $R_L=2k\Omega$, $C_L=10pF$	-	40	-	V/ μs

■ NOTE

The output current should not exceed the maximum output peak current (250mA) of absolute maximum ratings. If the maximum output peak current exceeds 250mA, connect a current-limiting resistor to the output.

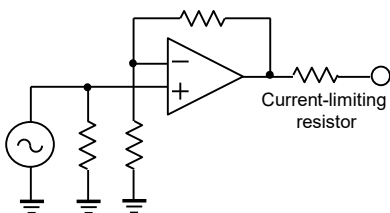

Calculating formula: $R= V/ I$

$R(\Omega)$: Current-limiting resistor

$V(V)$: Supply voltage

$I (A)$: Output peak current

Example

$18V/ 0.2A=90\Omega$ or more (91 Ω , 100 Ω)

$9V/ 0.2A=45\Omega$ or more (47 Ω , 51 Ω)

Resistance value is a reference value.

It does not guarantee the characteristics of the product.

■ TYPICAL CHARACTERISTICS

Note: Typical Characteristics are intended to be used as reference data; they are not guaranteed.

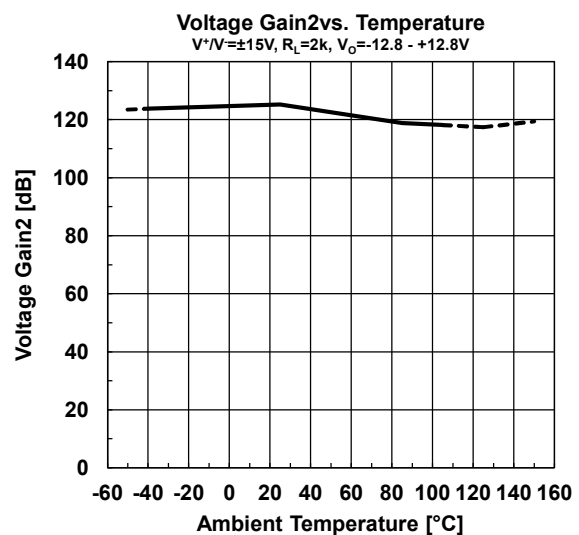
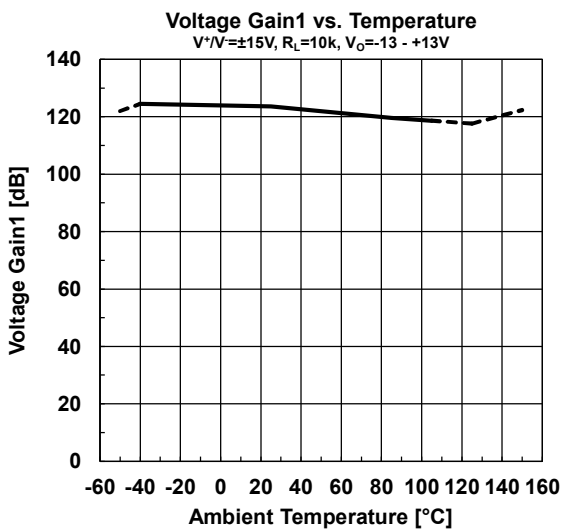
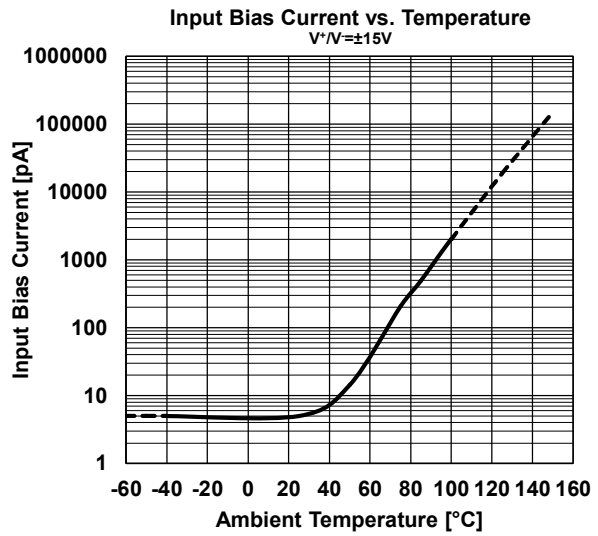
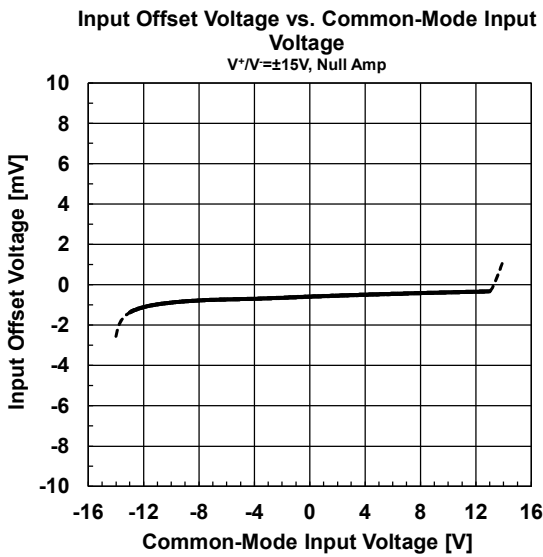
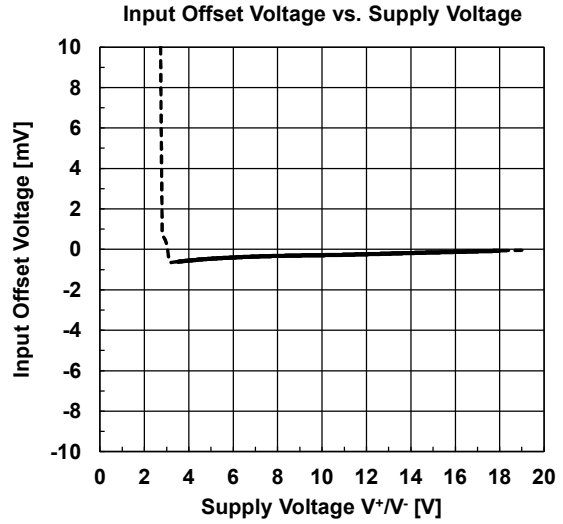
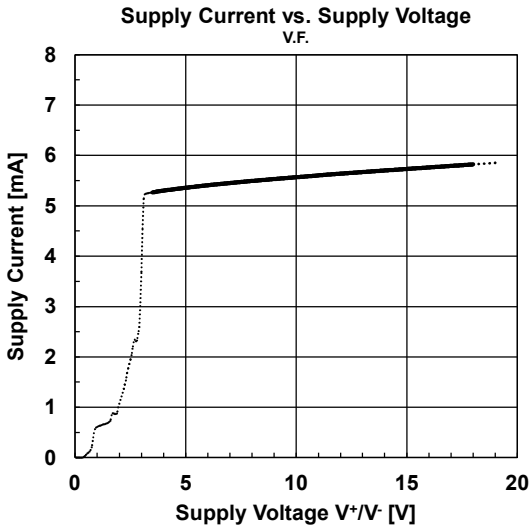

■ TYPICAL CHARACTERISTICS

Note: Typical Characteristics are intended to be used as reference data; they are not guaranteed.

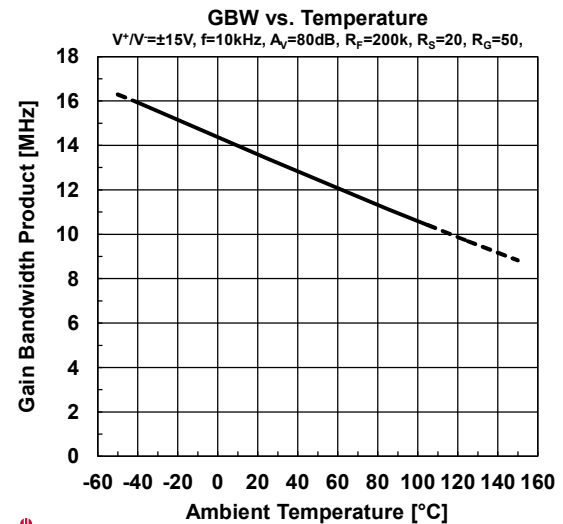
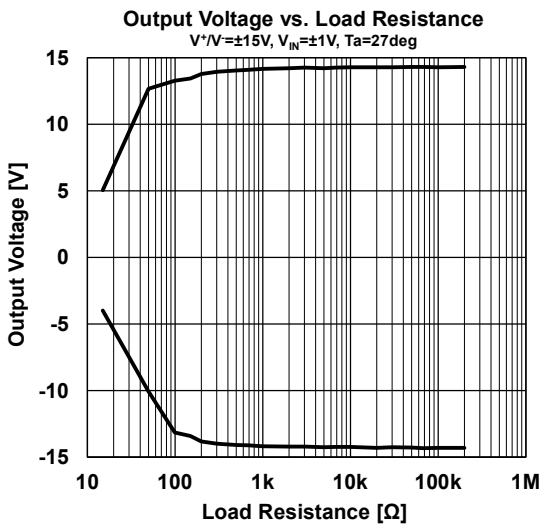
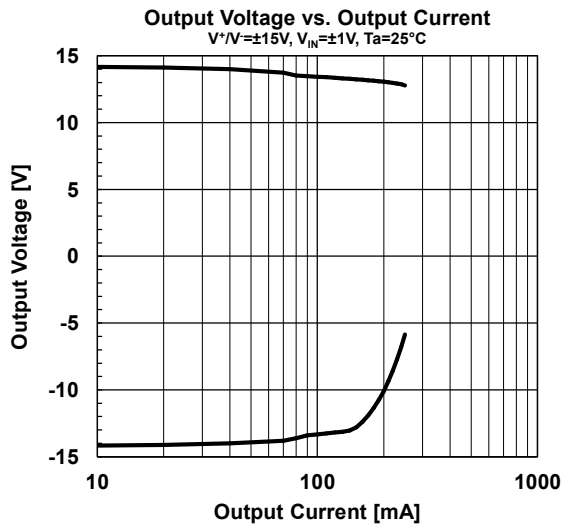
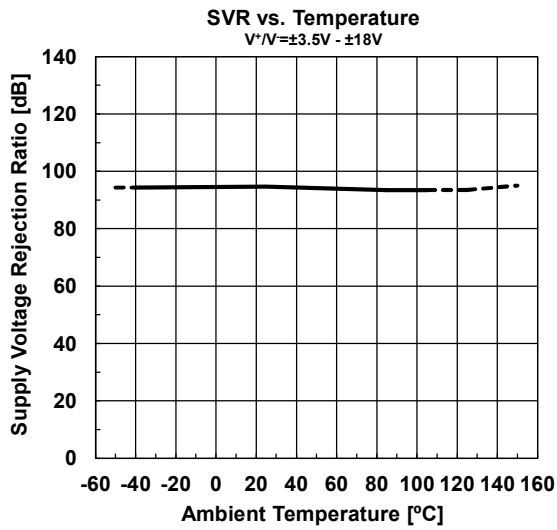
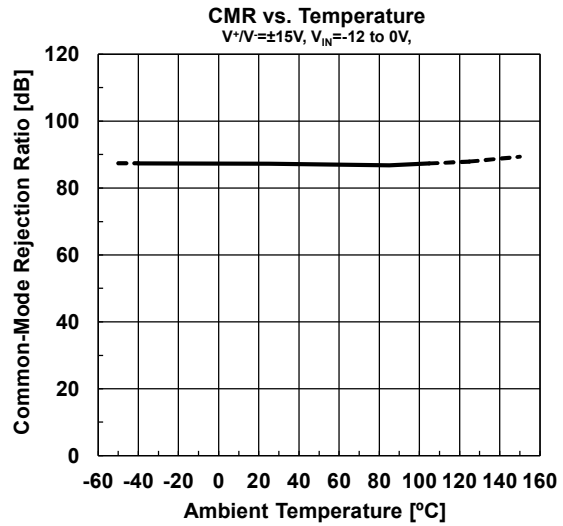
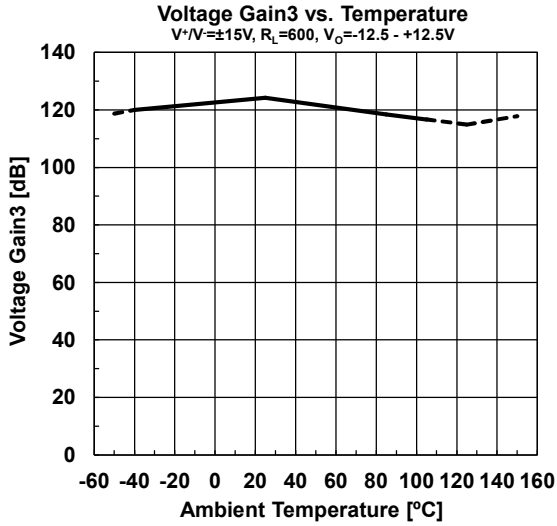

■ TYPICAL CHARACTERISTICS

Note: Typical Characteristics are intended to be used as reference data; they are not guaranteed.

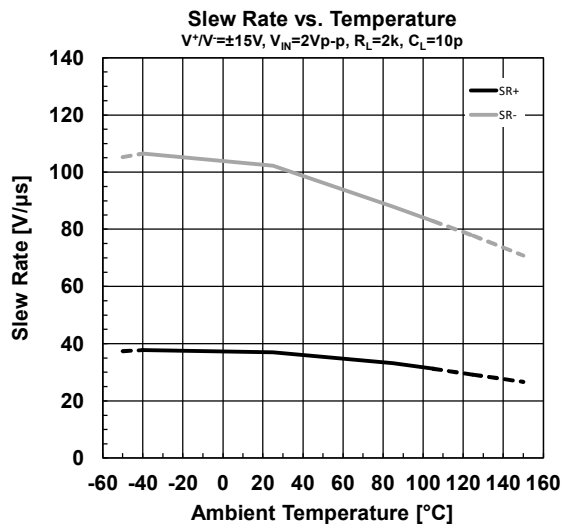
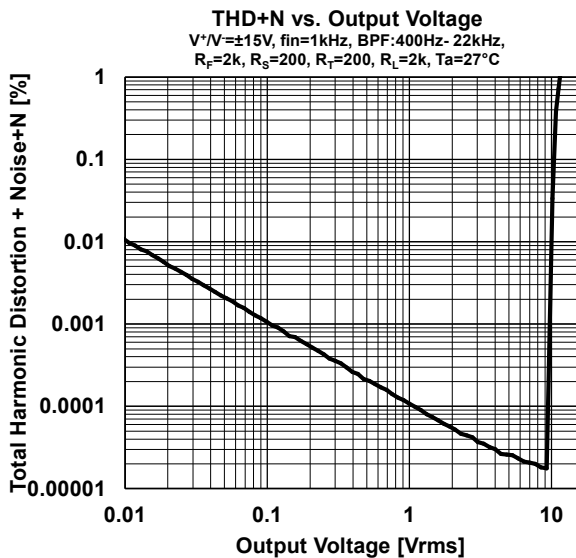
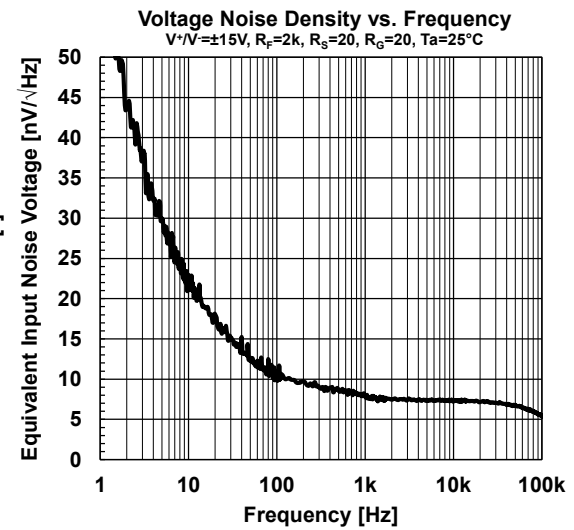
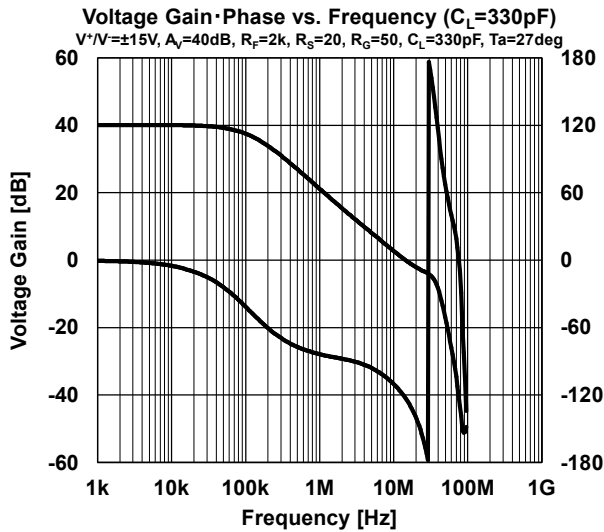
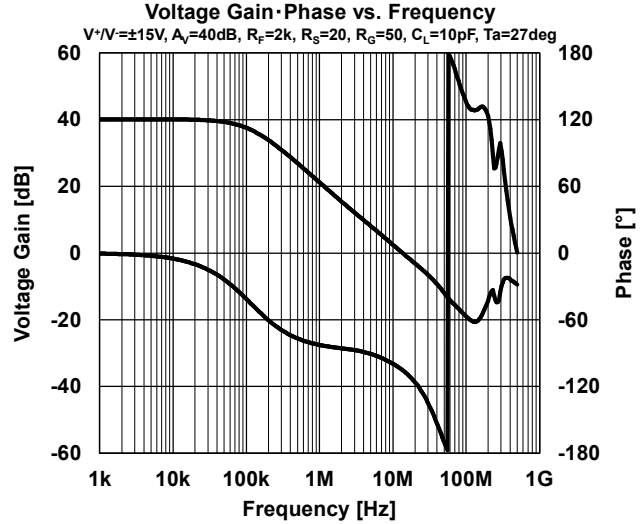
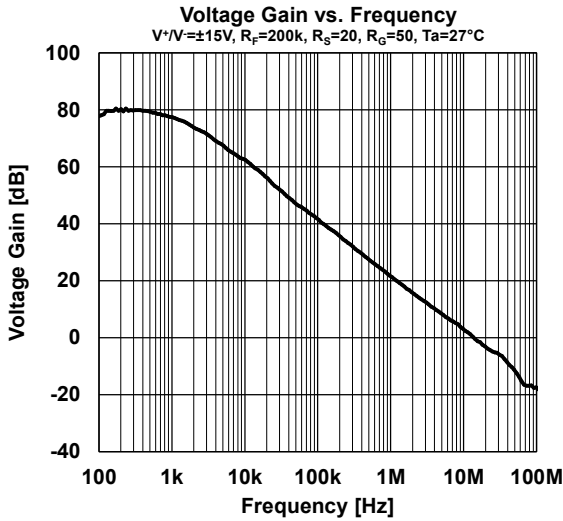

■ TEST CIRCUITS

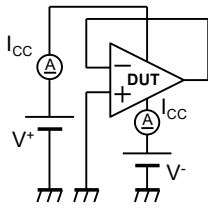

Figure1. Supply Current

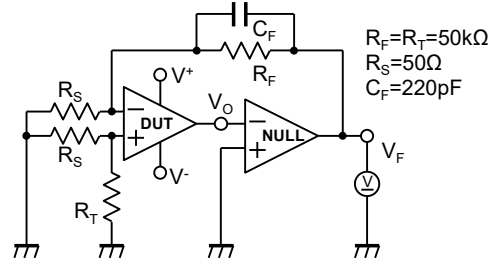

Figure2. Input Offset Voltage
Supply Voltage Rejection Ratio

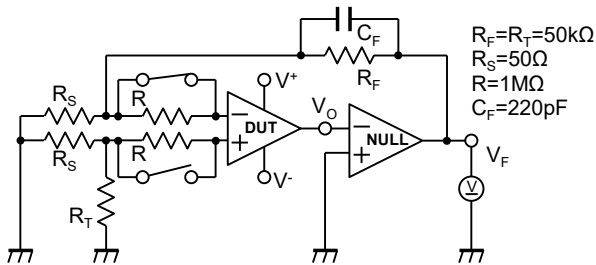

Figure3. Input Bias Current

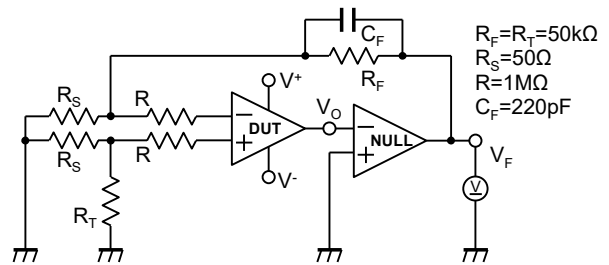

Figure4. Input Offset Current

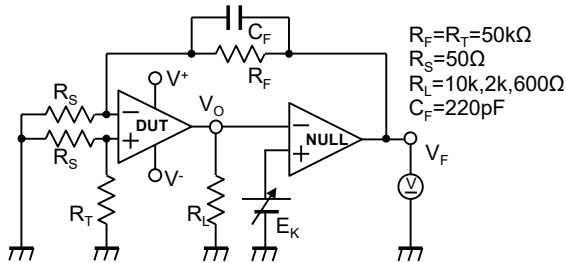

Figure5. Open-Loop Voltage Gain

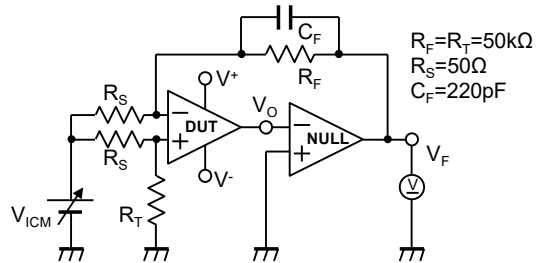

Figure6. Common Mode Rejection Ratio

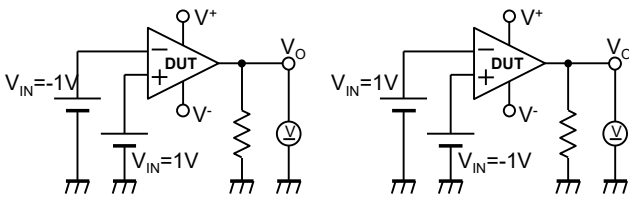

Figure7. Maximum Output Voltage

■ TEST CIRCUITS

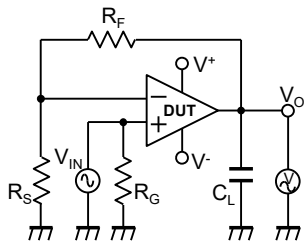

Figure8. Gain Bandwidth Product
 Phase Margin

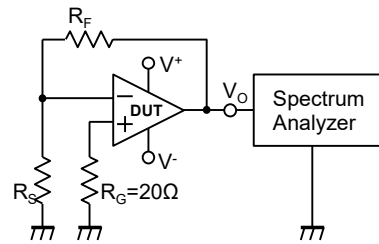

Figure9. Input Noise Voltage

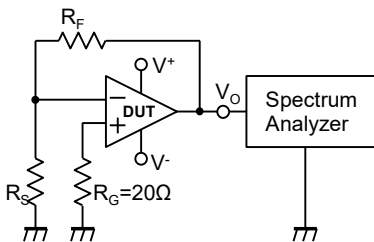

Figure10. Slew Rate

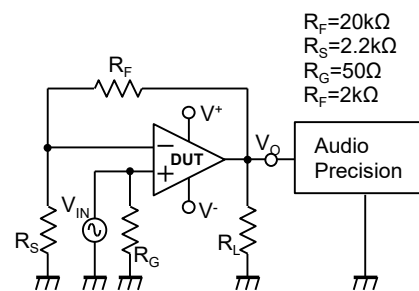

Figure11. Total Harmonic Distortion

■ REVISION HISTORY

DATE	REVISION	CHANGES
July 11, 2022	Ver.1.0	Initial Release

Nisshinbo Micro Devices Inc.

DFN12-CA8(ESON12-CA8)

PI-DFN12-CA8-E-A

■ PACKAGE DIMENSIONS

UNIT: mm

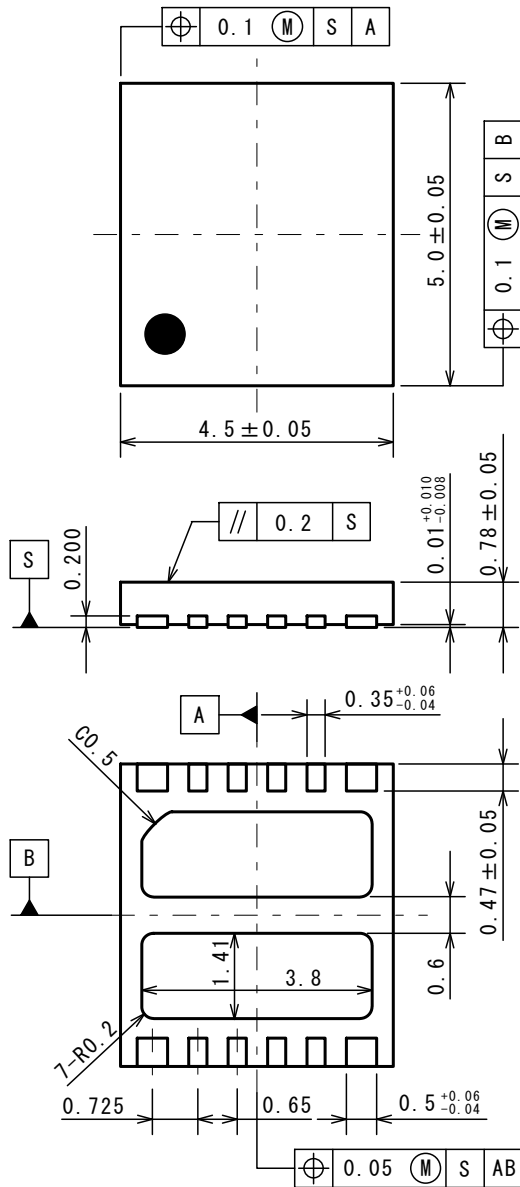

■ EXAMPLE OF SOLDER PADS DIMENSIONS

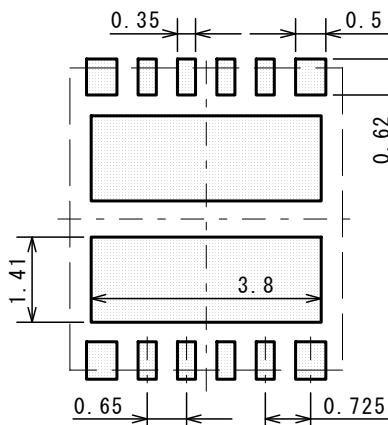

■ MARKING SPECIFICATION

①②: Product Code

③④⑤⑥⑦⑧: Lot No. ... Alphanumerical Serial Number

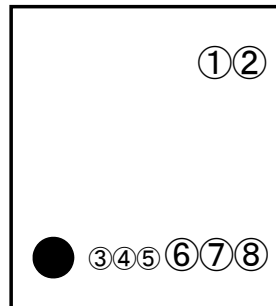

DFN12-CA8 (ESON12-CA8) Marking

NOTICE

There can be variation in the marking when different AOI (Automated Optical Inspection) equipment is used. In the case of recognizing the marking characteristic with AOI, please contact our sales or distributor before attempting to use AOI.

Nisshinbo Micro Devices Inc.

DFN12-CA8(ESON12-CA8)

PI-DFN12-CA8-E-A

■ PACKING SPEC

UNIT: mm

(1) Taping dimensions / Insert direction

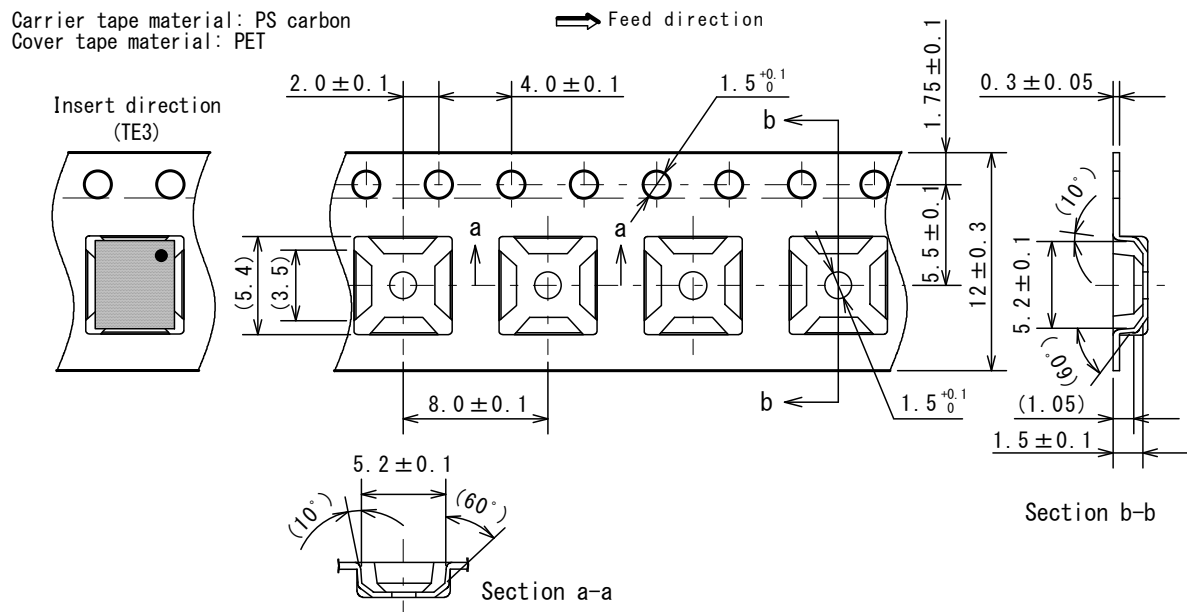

(2) Taping state

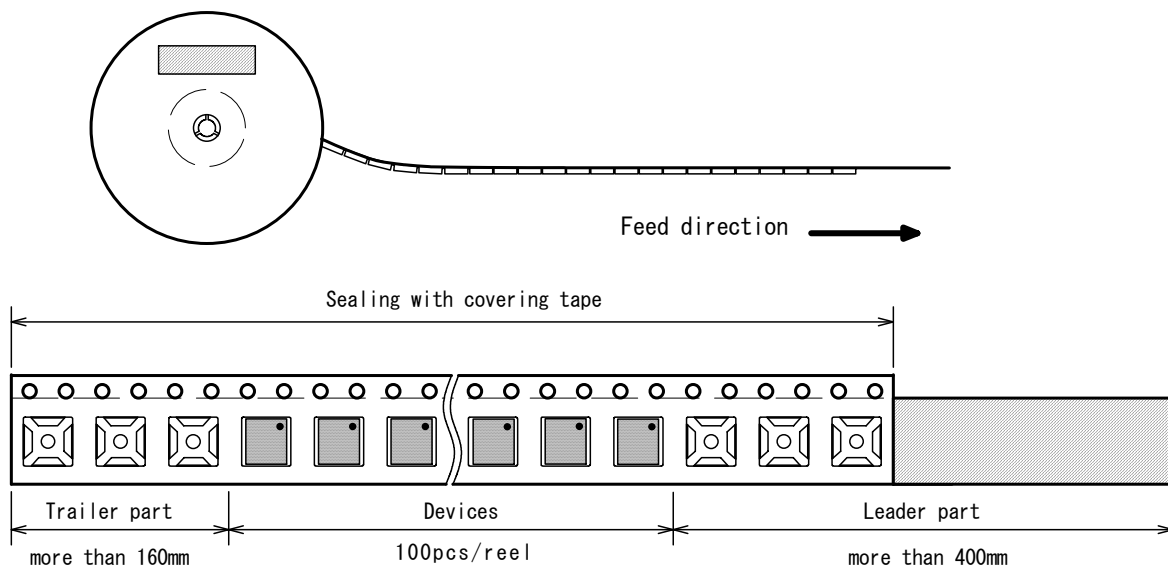

(3) Reel dimensions

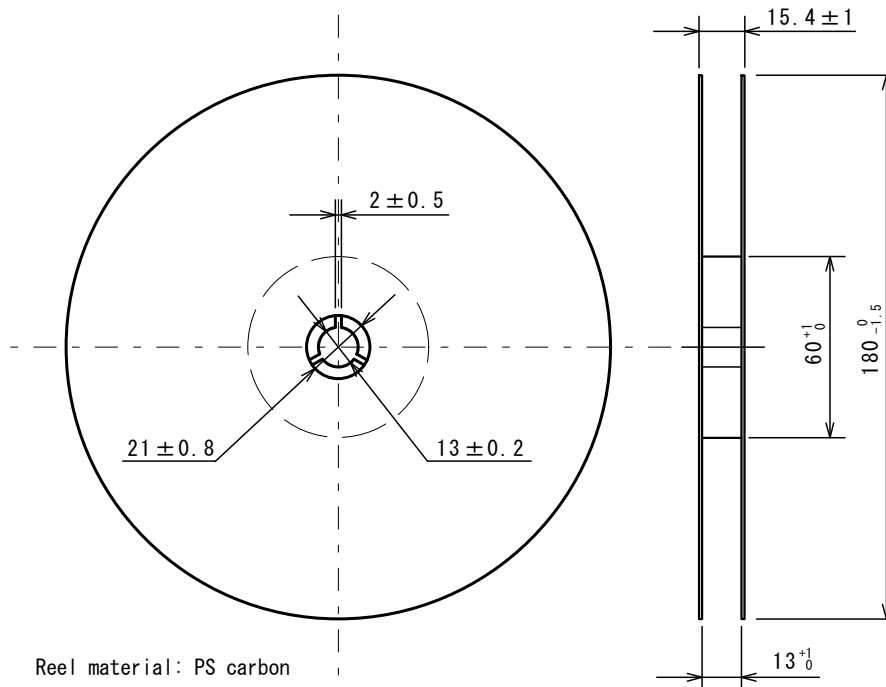

(4) Peeling strength

Peeling strength of cover tape

- Peeling angle 165 to 180° degrees to the taped surface.
- Peeling speed 300mm/min
- Peeling strength 0.1 to 1.3N

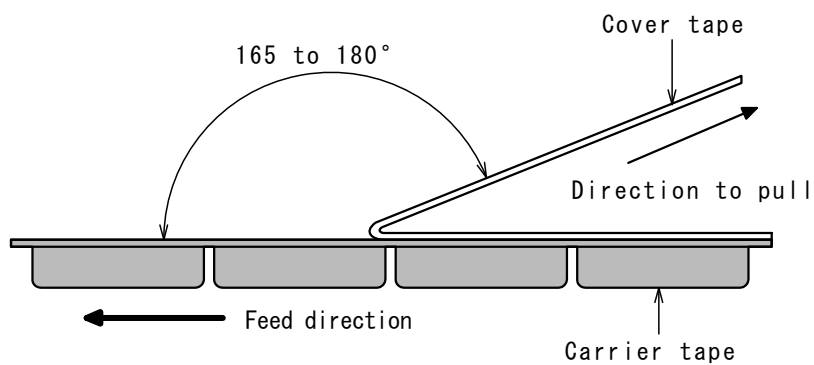

Nisshinbo Micro Devices Inc.

DFN12-CA8(ESON12-CA8)

PI-DFN12-CA8-E-A

(5) Packing state

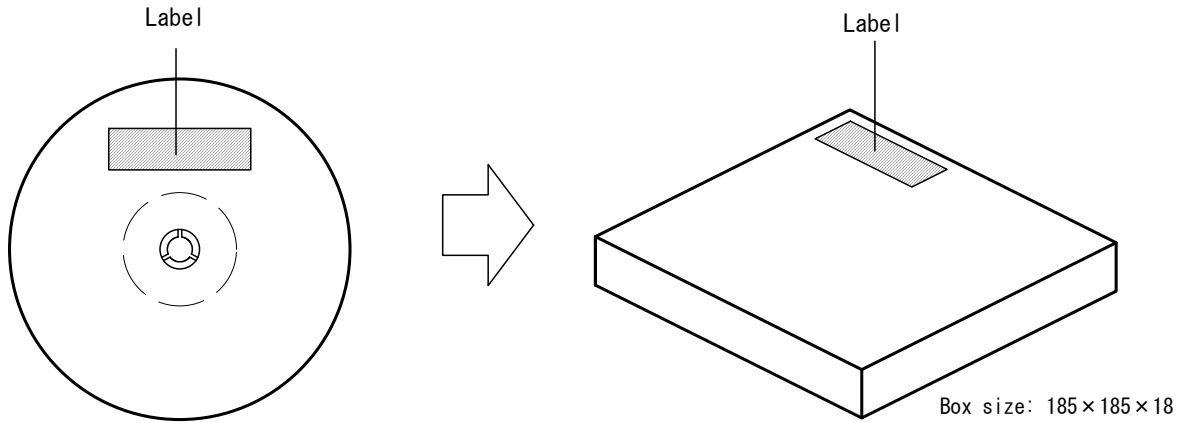

(6) Label

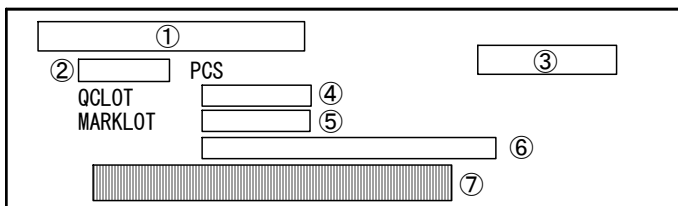

①	Product name
②	Quantity
③	Product code
④	QC LOT No.
⑤	MARK LOT No.
⑥	Environmental notation
⑦	Barcode

■ HEAT-RESISTANCE PROFILES

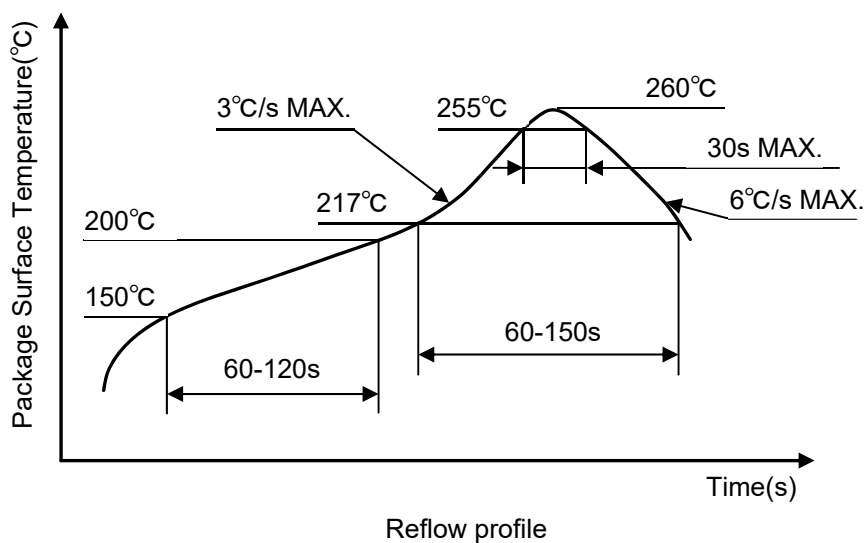

1. The products and the product specifications described in this document are subject to change or discontinuation of production without notice for reasons such as improvement. Therefore, before deciding to use the products, please refer to our sales representatives for the latest information thereon.
2. The materials in this document may not be copied or otherwise reproduced in whole or in part without the prior written consent of us.
3. This product and any technical information relating thereto are subject to complementary export controls (so-called KNOW controls) under the Foreign Exchange and Foreign Trade Law, and related politics ministerial ordinance of the law. (Note that the complementary export controls are inapplicable to any application-specific products, except rockets and pilotless aircraft, that are insusceptible to design or program changes.) Accordingly, when exporting or carrying abroad this product, follow the Foreign Exchange and Foreign Trade Control Law and its related regulations with respect to the complementary export controls.
4. The technical information described in this document shows typical characteristics and example application circuits for the products. The release of such information is not to be construed as a warranty of or a grant of license under our or any third party's intellectual property rights or any other rights.
5. The products listed in this document are intended and designed for use as general electronic components in standard applications (office equipment, telecommunication equipment, measuring instruments, consumer electronic products, amusement equipment etc.). Those customers intending to use a product in an application requiring extreme quality and reliability, for example, in a highly specific application where the failure or misoperation of the product could result in human injury or death should first contact us.
 - Aerospace Equipment
 - Equipment Used in the Deep Sea
 - Power Generator Control Equipment (nuclear, steam, hydraulic, etc.)
 - Life Maintenance Medical Equipment
 - Fire Alarms / Intruder Detectors
 - Vehicle Control Equipment (automotive, airplane, railroad, ship, etc.)
 - Various Safety Devices
 - Traffic control system
 - Combustion equipment

In case your company desires to use this product for any applications other than general electronic equipment mentioned above, make sure to contact our company in advance. Note that the important requirements mentioned in this section are not applicable to cases where operation requirements such as application conditions are confirmed by our company in writing after consultation with your company.

6. We are making our continuous effort to improve the quality and reliability of our products, but semiconductor products are likely to fail with certain probability. In order to prevent any injury to persons or damages to property resulting from such failure, customers should be careful enough to incorporate safety measures in their design, such as redundancy feature, fire containment feature and fail-safe feature. We do not assume any liability or responsibility for any loss or damage arising from misuse or inappropriate use of the products.
7. The products have been designed and tested to function within controlled environmental conditions. Do not use products under conditions that deviate from methods or applications specified in this datasheet. Failure to employ the products in the proper applications can lead to deterioration, destruction or failure of the products. We shall not be responsible for any bodily injury, fires or accident, property damage or any consequential damages resulting from misuse or misapplication of the products.
8. **Quality Warranty**
 - 8-1. **Quality Warranty Period**

In the case of a product purchased through an authorized distributor or directly from us, the warranty period for this product shall be one (1) year after delivery to your company. For defective products that occurred during this period, we will take the quality warranty measures described in section 8-2. However, if there is an agreement on the warranty period in the basic transaction agreement, quality assurance agreement, delivery specifications, etc., it shall be followed.
 - 8-2. **Quality Warranty Remedies**

When it has been proved defective due to manufacturing factors as a result of defect analysis by us, we will either deliver a substitute for the defective product or refund the purchase price of the defective product.

Note that such delivery or refund is sole and exclusive remedies to your company for the defective product.
 - 8-3. **Remedies after Quality Warranty Period**

With respect to any defect of this product found after the quality warranty period, the defect will be analyzed by us. On the basis of the defect analysis results, the scope and amounts of damage shall be determined by mutual agreement of both parties. Then we will deal with upper limit in Section 8-2. This provision is not intended to limit any legal rights of your company.
9. Anti-radiation design is not implemented in the products described in this document.
10. The X-ray exposure can influence functions and characteristics of the products. Confirm the product functions and characteristics in the evaluation stage.
11. WLCSP products should be used in light shielded environments. The light exposure can influence functions and characteristics of the products under operation or storage.
12. Warning for handling Gallium and Arsenic (GaAs) products (Applying to GaAs MMIC, Photo Reflector). These products use Gallium (Ga) and Arsenic (As) which are specified as poisonous chemicals by law. For the prevention of a hazard, do not burn, destroy, or process chemically to make them as gas or power. When the product is disposed of, please follow the related regulation and do not mix this with general industrial waste or household waste.
13. Please contact our sales representatives should you have any questions or comments concerning the products or the technical information.



Nisshinbo Micro Devices Inc.

Official website

<https://www.nisshinbo-microdevices.co.jp/en/>

Purchase information

<https://www.nisshinbo-microdevices.co.jp/en/buy/>