

# MUX8507 64-Channel Analog Multiplexer Module

## Radiation Tolerant

[www.aeroflex.com/mux](http://www.aeroflex.com/mux)

May 5, 2014

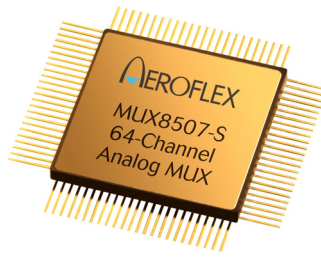

### FEATURES

- 64-Channels provided by six 16-channel multiplexers- 32 Kelvin measurement configured channels
- Radiation performance
  - Total dose: 300 krad(Si), Dose rate = 50 - 300 rad(Si)/s
  - SEU: Immune up to 120 MeV-cm<sup>2</sup>/mg
  - SEL: Immune by process design
- Full military temperature range
- Low power consumption < 90mW
- Two address buses (A0-3 & B0-3) and four enable lines afford flexible organization.
- Fast access time 1500ns typical
- Break-Before-Make switching
- Same *Form / Fit / Function* as ACT8500 minus channel input transorbs
- High analog input impedance (power on or off) ?
- Designed for aerospace and high reliability space applications
- Packaging – Hermetic ceramic
  - 96 leads, 1.32" Sq x 0.20"Ht quad flat pack
  - Typical Weight 15 grams
- Aeroflex Plainview's Radiation Hardness Assurance Plan is DLA Certified to MIL-PRF-38534, Appendix G.

### GENERAL DESCRIPTION

Aeroflex's MUX8507 is a radiation tolerant, 64 channel multiplexer MCM (multi-chip module).

The MUX8507 has been specifically designed to meet exposure to radiation environments. It is available in a 96 lead High Temperature Co-Fired Ceramic (HTCC) Quad Flatpack (CQFP). It is guaranteed operational from -55°C to +125°C. Available screened in accordance with MIL-PRF-38534, the MUX8507 is ideal for demanding military and space applications.

### ORGANIZATION AND APPLICATION

The MUX8507 consists of six 16 channel multiplexers arranged as shown in the Block Diagram. The MUX8507 design is inherently radiation tolerant.

#### A SECTION

Thirty-two (32) Kelvin measurement channels addressable by bus A<sub>0</sub>~A<sub>3</sub>, in two 16 channel blocks, each block enabled separately. Each block connects the addressed channel to two outputs, "Output" and "Current". This technique enables selecting and reading a remote resistive sensor without the multiplexer resistance being part of the measurement. For grounded sensors, this is done by passing current to the sensor by means of the "Current" pin and reading the resultant voltage (proportional to the sensor resistance) at the "Output" pin.

#### B SECTION

Thirty-two (32) channels addressable by bus B<sub>0</sub>~B<sub>3</sub>, in two 16 channel blocks, each block enabled separately. Each block connects the addressed channel to one output. By paralleling the channel inputs and enables, this section can be converted to act like one of the 16 channel blocks of the A section.

**SECTION B**

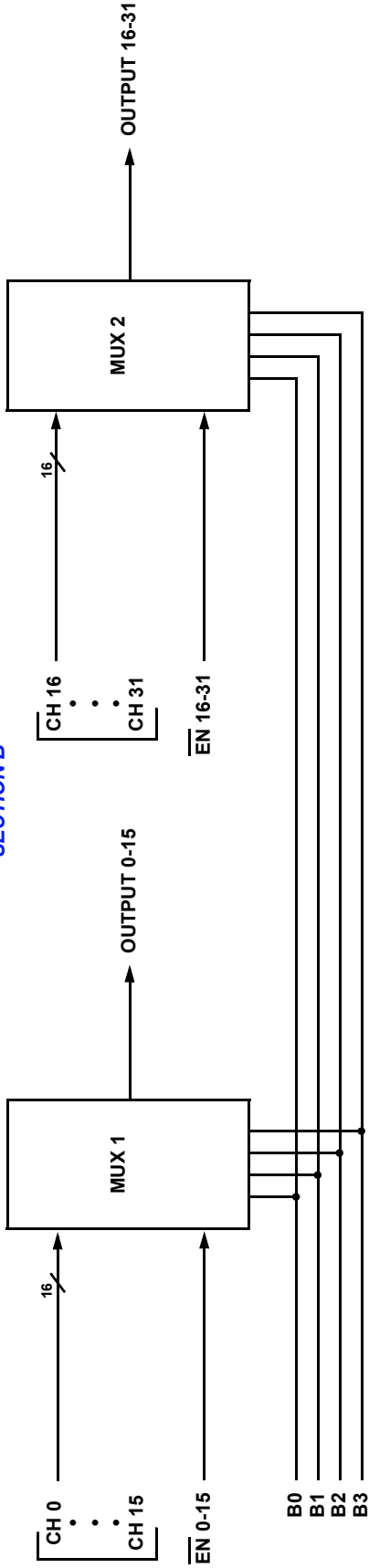

**SECTION A: Kelvin Measurement Configured**

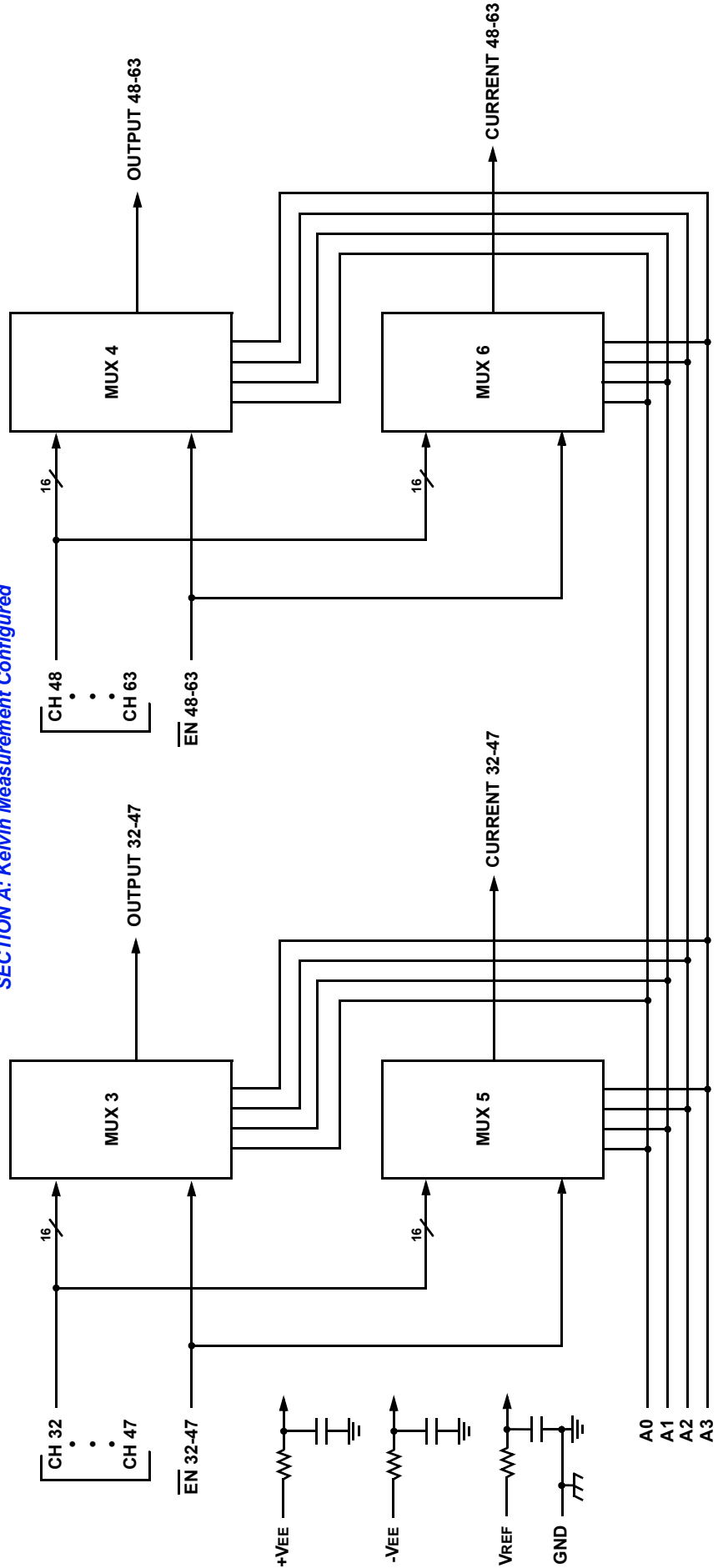

**MUX8507 64-CHANNEL ANALOG MUX BLOCK DIAGRAM**

## ABSOLUTE MAXIMUM RATINGS <sup>1/</sup>

Parameter	Range	Units
Case Operating Temperature Range	-55 to +125	°C
Storage Temperature Range	-65 to +150	°C
Supply Voltage +VEE (Pin 44) -VEE (Pin 46) VREF (Pin 48)	+16.5 -16.5 +16.5	V V V
Digital Input Overvoltage VEN (Pins 5, 6, 91, 92), VA (Pins 1, 3, 93, 95), VB (Pins 2, 4, 94, 96)	< VREF +4 > GND -4	V V
Analog Input Over Voltage VIN	±35	V

Notes:

<sup>1/</sup> All measurements are made with respect to ground.

NOTICE: Stresses above those listed under "Absolute Maximum Ratings" may cause permanent damage to the device. These are stress rating only; functional operation beyond the "Operation Conditions" is not recommended and extended exposure beyond the "Operation Conditions" may affect device reliability.

## RECOMMENDED OPERATING CONDITIONS <sup>1/</sup>

Symbol	Parameter	Typical	Units
+VEE	Positive Power Supply Voltage	+12.0 to +15.0 dc ± 5%	V
-VEE	Negative Power Supply Voltage	-12.0 to -15.0 dc ± 5%	V
VREF	Reference Voltage	+5.0	V
VAL	Logic Low Level	+0.8	V
VAH	Logic High Level	+4.0	V

Notes:

<sup>1/</sup> Power Supply turn-on sequence shall be as follows: +VEE, -VEE, followed by VREF.

## DC ELECTRICAL PERFORMANCE CHARACTERISTICS <sup>1/</sup>

(T<sub>c</sub> = -55°C to +125°C, +VEE = +15.75V, -VEE = -15.75V, VREF = +5.0V, Unless otherwise specified)

Parameter	Symbol	Conditions	Min	Max	Units
Supply Current	+IEE	VEN(0-63) = VA(0-3)A = VA(0-3)B = 0	0	3	mA
	-IEE		-3	0	mA
	+ISBY	VEN(0-63) = 4V, VA(0-3)A = VA(0-3)B = 0 <sup>6/</sup>	0	3	mA
	-ISBY		-3	0	mA
Address Input Current	I <sub>AL</sub> (0-3)A	VA = 0V <sup>8/</sup>	-4	4	μA
	I <sub>AH</sub> (0-3)A	VA = 5V <sup>8/</sup>	-4	4	μA
	I <sub>AL</sub> (0-3)B	VB = 0V <sup>8/</sup>	-2	2	μA
	I <sub>AH</sub> (0-3)B	VB = 5V <sup>8/</sup>	-2	2	μA
Enable Input Current	I <sub>ENL</sub> (0-15)	VEN(0-15) = 0V <sup>8/</sup>	-1	1	μA
	I <sub>ENH</sub> (0-15)	VEN(0-15) = 5V <sup>8/</sup>	-1	1	μA
	I <sub>ENL</sub> (16-31)	VEN(16-31) = 0V <sup>8/</sup>	-1	1	μA
	I <sub>ENH</sub> (16-31)	VEN(16-31) = 5V <sup>8/</sup>	-1	1	μA
	I <sub>ENL</sub> (32-47)	VEN(32-47) = 0V <sup>8/</sup>	-2	2	μA
	I <sub>ENH</sub> (32-47)	VEN(32-47) = 5V <sup>8/</sup>	-2	2	μA
	I <sub>ENL</sub> (48-63)	VEN(48-63) = 0V <sup>8/</sup>	-2	2	μA
	I <sub>ENH</sub> (48-63)	VEN(48-63) = 5V <sup>8/</sup>	-2	2	μA

## DC ELECTRICAL PERFORMANCE CHARACTERISTICS 1/ (continued)

(Tc = -55°C to +125°C, +VEE = +15.75V, -VEE = -15.75V, VREF = +5.0V, Unless otherwise specified)

Parameter	Symbol	Conditions	Min	Max	Units	
Positive Input Leakage Current CH0-CH31	+ISOFFOUTPUT(0-31)	VIN = +10V, VEN = 4V, output and all unused MUX inputs under test = -10V 2/, 3/, 8/	+25°C	-10	+10	nA
			-	-100	+100	nA
Positive Input Leakage Current CH32-CH63	+ISOFFOUTPUT(32-63)	VIN = +10V, VEN = 4V, output and all unused MUX inputs under test = -10V 2/, 3/, 8/	+25°C	-20	+20	nA
	+ISOFFCURRENT(32-63)		-	-200	+200	nA
Negative Input Leakage Current CH0-CH31	-ISOFFOUTPUT(0-31)	VIN = -10V, VEN = 4V, output and all unused MUX inputs under test = +10V 2/, 3/, 8/	+25°C	-10	+10	nA
			-	-100	+100	nA
Negative Input Leakage Current CH32-CH63	-ISOFFOUTPUT(32-63)	VIN = -10V, VEN = 4V, output and all unused MUX inputs under test = +10V 2/, 3/, 8/	+25°C	-20	+20	nA
	-ISOFFCURRENT(32-63)		-	-200	+200	nA
Output Leakage Current OUTPUTS (pins 25, 26, 68 & 70)	+IDOFFOUTPUT	VOUT = +10V, VEN = 4V, output and all unused MUX inputs under test = -10V 3/, 4/, 8/	-100	+100	nA	
CURRENTS (pins 67 & 69)	+IDOFFCURRENT		-100	+100	nA	
Output Leakage Current OUTPUTS (pins 25, 26, 68 & 70)	-IDOFFOUTPUT	VOUT = -10V, VEN = 4V, output and all unused MUX inputs under test = +10V 3/, 4/, 8/	-100	+100	nA	
CURRENTS (pins 67 & 69)	-IDOFFCURRENT		-100	+100	nA	
Switch ON Resistance OUTPUTS (pins 25, 26, 68 & 70)	RDS(ON)(0-63) <sub>A</sub>	VIN = +15.75V, VEN = 0.8V, IOUT = -1mA 2/, 3/, 5/	500	3000	Ω	
	RDS(ON)(0-63) <sub>B</sub>	VIN = +5V, VEN = 0.8V, IOUT = -1mA 2/, 3/, 5/	500	3000	Ω	
	RDS(ON)(0-63) <sub>C</sub>	VIN = -5V, VEN = 0.8V, IOUT = +1mA 2/, 3/, 5/	500	3000	Ω	
Switch ON Resistance CURRENTS (pins 67 & 69)	RDS(ON)(0-63) <sub>A</sub>	VIN = +15.75V, VEN = 0.8V, IOUT = -1mA 2/, 3/, 5/	500	3000	Ω	
	RDS(ON)(0-63) <sub>B</sub>	VIN = +5V, VEN = 0.8V, IOUT = -1mA 2/, 3/, 5/	500	3000	Ω	
	RDS(ON)(0-63) <sub>C</sub>	VIN = -5V, VEN = 0.8V, IOUT = +1mA 2/, 3/, 5/	500	3000	Ω	
Switch ON Resistance OUTPUTS (pins 25, 26, 68 & 70)	RDS(ON)(0-63) <sub>A</sub>	VIN = +11.4V, VEN = 0.8V, IOUT = -1mA 2/, 3/, 5/, 7/	500	3200	Ω	
	RDS(ON)(0-63) <sub>B</sub>	VIN = +5V, VEN = 0.8V, IOUT = -1mA 2/, 3/, 5/, 7/	500	3000	Ω	
	RDS(ON)(0-63) <sub>C</sub>	VIN = -5V, VEN = 0.8V, IOUT = +1mA 2/, 3/, 5/, 7/	500	3000	Ω	
Switch ON Resistance CURRENTS (pins 67 & 69)	RDS(ON)(32-63) <sub>A</sub>	VIN = +11.4V, VEN = 0.8V, IOUT = -1mA 2/, 3/, 5/, 7/	500	3200	Ω	
	RDS(ON)(32-63) <sub>B</sub>	VIN = +5V, VEN = 0.8V, IOUT = -1mA 2/, 3/, 5/, 7/	500	3000	Ω	
	RDS(ON)(32-63) <sub>C</sub>	VIN = -5V, VEN = 0.8V, IOUT = +1mA 2/, 3/, 5/, 7/	500	3000	Ω	

**Notes:**

- 1/ Measure inputs sequentially. Ground all unused inputs of the device under test. VA is the applied input voltage to the address lines A(0-3). VB is the applied input voltage to the address lines B(0-3).
- 2/ VIN is the applied input voltage to the input channels CH0-CH63.
- 3/ VEN is the applied input voltage to the enable lines EN (0-15), EN (16-31), EN (32-47) and EN (48-63).
- 4/ VOUT is the applied input voltage to the output lines OUTPUT(0-15), OUTPUT(16-31), OUTPUT(32-47), OUTPUT(48-63), CURRENT(32-47) and CURRENT(48-63).
- 5/ Negative current is the current flowing out of each of the MUX pins. Positive current is the current flowing into each MUX pin.
- 6/ Not tested, guaranteed to the specified limits.
- 7/ +VEE = +11.4 Vdc, -VEE = -11.4 Vdc and VREF = 5.0 V
- 8/ These parameters for Tc = -55°C are guaranteed by design, characterization, or correlation to other test parameters but not production tested.

## SWITCHING CHARACTERISTICS

(T<sub>c</sub> = -55°C to +125°C, +V<sub>EE</sub> = +15.75V, -V<sub>EE</sub> = -15.75V, V<sub>REF</sub> = +5.0V, Unless otherwise specified)

Parameter	Symbol	Conditions	Min	Max	Units	
Switching Test MUX	t <sub>AHL</sub>	R <sub>L</sub> = 10KΩ, C <sub>L</sub> = 50pF	T <sub>c</sub> = +25°C, +125°C	10	1500	ns
			T <sub>c</sub> = -55°C	10	3500	ns
	t <sub>ALH</sub>	R <sub>L</sub> = 10KΩ, C <sub>L</sub> = 50pF	T <sub>c</sub> = +25°C, +125°C	10	2000	ns
			T <sub>c</sub> = -55°C	10	5000	ns
	t <sub>ONEN</sub>	R <sub>L</sub> = 1KΩ, C <sub>L</sub> = 50pF	10	1500	ns	
	t <sub>OFFEN</sub>	R <sub>L</sub> = 1KΩ, C <sub>L</sub> = 50pF <u>1/</u>	10	1000	ns	

Notes:

1/ +V<sub>EE</sub> = +11.4 Vdc, -V<sub>EE</sub> = -11.4 Vdc and V<sub>REF</sub> = 5.0 V

### TRUTH TABLE (CH0 – CH15)

B3	B2	B1	B0	EN(0-15)	"ON" CHANNEL 1/
X	X	X	X	H	NONE
L	L	L	L	L	CH0
L	L	L	H	L	CH1
L	L	H	L	L	CH2
L	L	H	H	L	CH3
L	H	L	L	L	CH4
L	H	L	H	L	CH5
L	H	H	L	L	CH6
L	H	H	H	L	CH7
H	L	L	L	L	CH8
H	L	L	H	L	CH9
H	L	H	L	L	CH10
H	L	H	H	L	CH11
H	H	L	L	L	CH12
H	H	L	H	L	CH13
H	H	H	L	L	CH14
H	H	H	H	L	CH15

1/ Between CH0-15 and OUTPUT (0-15)

### TRUTH TABLE (CH16 – CH31)

B3	B2	B1	B0	EN(16-31)	"ON" CHANNEL 1/
X	X	X	X	H	NONE
L	L	L	L	L	CH16
L	L	L	H	L	CH17
L	L	H	L	L	CH18
L	L	H	H	L	CH19
L	H	L	L	L	CH20
L	H	L	H	L	CH21
L	H	H	L	L	CH22
L	H	H	H	L	CH23
H	L	L	L	L	CH24
H	L	L	H	L	CH25
H	L	H	L	L	CH26
H	L	H	H	L	CH27
H	H	L	L	L	CH28
H	H	L	H	L	CH29
H	H	H	L	L	CH30
H	H	H	H	L	CH31

1/ Between CH16-31 and OUTPUT (16-31)

### TRUTH TABLE (CH32 – CH47)

A3	A2	A1	A0	EN(32-47)	"ON" CHANNEL 1/
X	X	X	X	H	NONE
L	L	L	L	L	CH32
L	L	L	H	L	CH33
L	L	H	L	L	CH34
L	L	H	H	L	CH35
L	H	L	L	L	CH36
L	H	L	H	L	CH37
L	H	H	L	L	CH38
L	H	H	H	L	CH39
H	L	L	L	L	CH40
H	L	L	H	L	CH41
H	L	H	L	L	CH42
H	L	H	H	L	CH43
H	H	L	L	L	CH44
H	H	L	H	L	CH45
H	H	H	L	L	CH46
H	H	H	H	L	CH47

1/ Between CH32-47 and OUTPUT (32-47) and CURRENT (32-47)

### TRUTH TABLE (CH48 – CH63)

A3	A2	A1	A0	EN(48-63)	"ON" CHANNEL 1/
X	X	X	X	H	NONE
L	L	L	L	L	CH48
L	L	L	H	L	CH49
L	L	H	L	L	CH50
L	L	H	H	L	CH51
L	H	L	L	L	CH52
L	H	L	H	L	CH53
L	H	H	L	L	CH54
L	H	H	H	L	CH55
H	L	L	L	L	CH56
H	L	L	H	L	CH57
H	L	H	L	L	CH58
H	L	H	H	L	CH59
H	H	L	L	L	CH60
H	H	L	H	L	CH61
H	H	H	L	L	CH62
H	H	H	H	L	CH63

1/ Between CH48-63 and OUTPUT (48-63) and CURRENT (48-63)

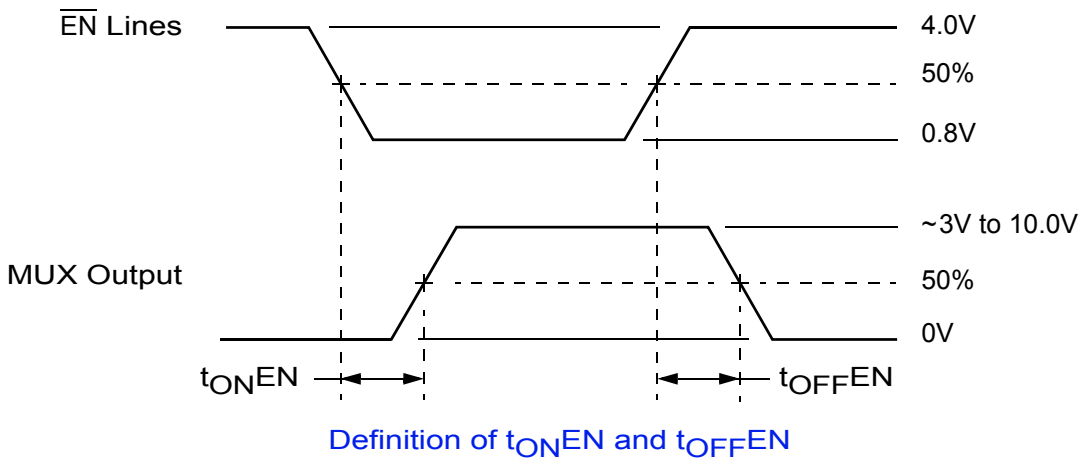
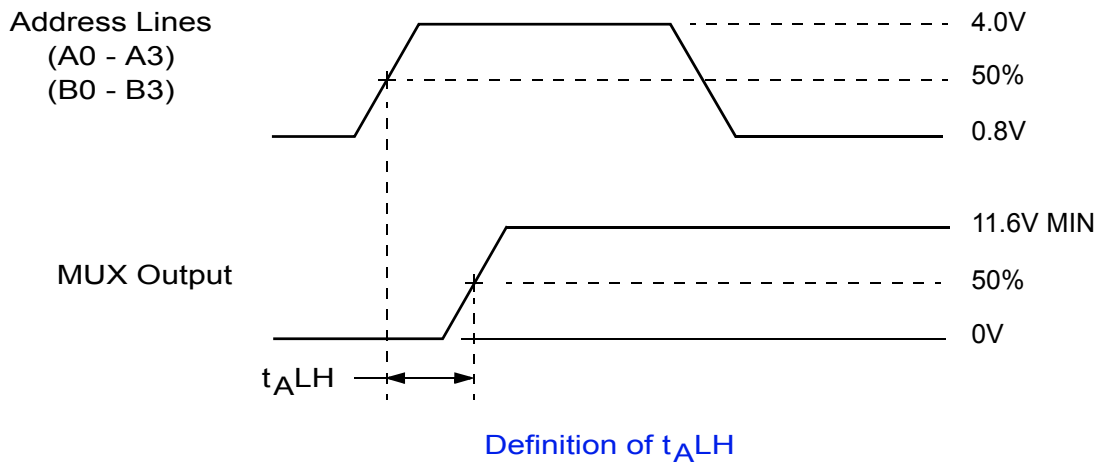
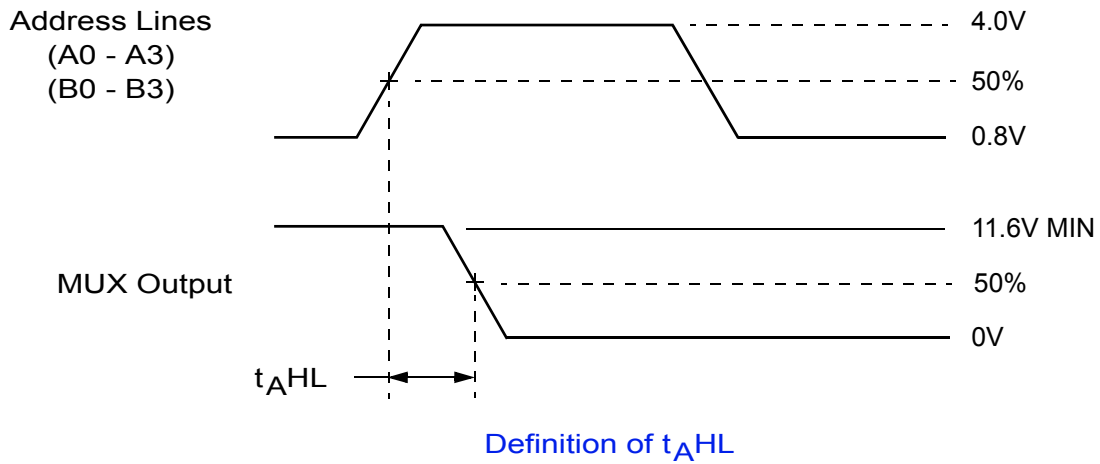

NOTE:  $f = 10\text{KHz}$ , Duty cycle = 50%.

### MUX8507 SWITCHING DIAGRAMS

## PIN NUMBERS & FUNCTIONS

MUX8507 – 96 Leads Ceramic QUAD Flat Pack					
Pin #	Function	Pin #	Function	Pin #	Function
1	A2	33	CH11	65	CH49
2	B2	34	CH27	66	CH48
3	A3	35	CH12	67	Output I (48-63)
4	B3	36	CH28	68	Output V (48-63)
5	$\overline{\text{EN}}$ 0-15	37	CH13	69	Output I (32-47)
6	$\overline{\text{EN}}$ 16-31	38	CH29	70	Output V (32-47)
7	CH0	39	CH14	71	GND
8	CH16	40	CH30	72	GND
9	CH1	41	CH15	73	CH47
10	CH17	42	CH31	74	CH46
11	CH2	43	NC	75	CH45
12	CH18	44	+VEE	76	CH44
13	CH3	45	NC	77	CH43
14	CH19	46	-VEE	78	CH42
15	CH4	47	NC	79	CH41
16	CH20	48	VREF	80	CH40
17	CH5	49	NC	81	CH39
18	CH21	50	CASE GND	82	CH38
19	CH6	51	CH63	83	CH37
20	CH22	52	CH62	84	CH36
21	CH7	53	CH61	85	CH35
22	CH23	54	CH60	86	CH34
23	GND	55	CH59	87	CH33
24	GND	56	CH58	88	CH32
25	Output V (0-15)	57	CH57	89	GND
26	Output V (16-31)	58	CH56	90	GND
27	CH8	59	CH55	91	$\overline{\text{EN}}$ 48-63
28	CH24	60	CH54	92	$\overline{\text{EN}}$ 32-47
29	CH9	61	CH53	93	A0
30	CH25	62	CH52	94	B0
31	CH10	63	CH51	95	A1
32	CH26	64	CH50	96	B1

**Notes:**

- 1) It is recommended that all "NC" or "no connect pin" be grounded. This eliminates or minimizes any ESD or static buildup.
- 2) Package lid is internally connected to circuit ground (Pins 23, 24, 50, 71, 72, 89 & 90)



## ORDERING INFORMATION

Model	DLA SMD #	Screening	Package
MUX8507-7	-	Commercial Flow, +25°C testing only	QUAD Flat Pack
MUX8507-201-1S	5962-1021201KXC	In accordance with DLA SMD	
MUX8507-901-1S	5962F1021201KXC	In accordance with DLA Certified RHA Program Plan to RHA Level "F", 300krad(Si)	

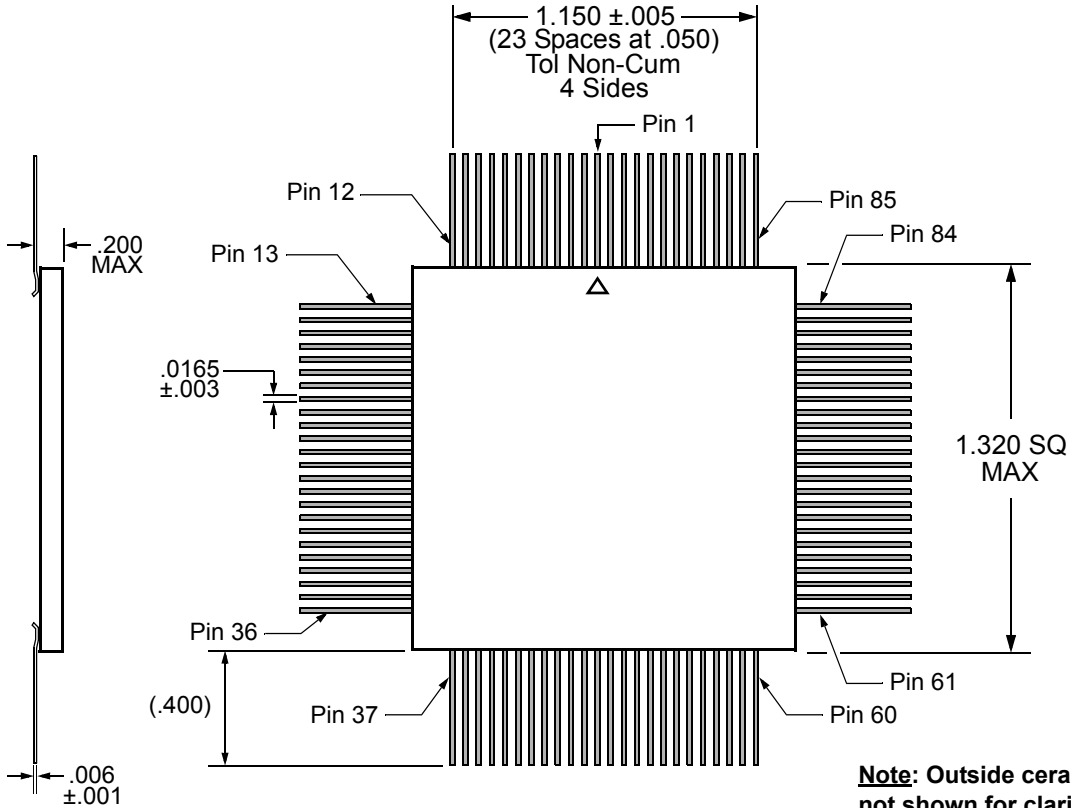

## FLAT PACKAGE OUTLINE

### EXPORT CONTROL:

This product is controlled for export under the International Traffic in Arms Regulations (ITAR). A license from the U.S. Government is required prior to the export of this product from the United States.

[www.aeroflex.com/HiRel](http://www.aeroflex.com/HiRel)    [info-ams@aeroflex.com](mailto:info-ams@aeroflex.com)

### Datasheet Definitions:

Advanced Preliminary Datasheet	Product in Development Shipping Non-Flight Prototypes Shipping QML and Reduced HiRel
--------------------------------	--



Aeroflex Plainview, Inc. reserves the right to make changes to any products and services described herein at any time without notice. Consult Aeroflex or an authorized sales representative to verify that the information in this data sheet is current before using this product. Aeroflex does not assume any responsibility or liability arising out of the application or use of any product or service described herein, except as expressly agreed to in writing by Aeroflex; nor does the purchase, lease, or use of a product or service from Aeroflex convey a license under any patent rights, copyrights, trademark rights, or any other of the intellectual rights of Aeroflex or of third parties.

Our passion for performance is defined by three attributes.



Solution-Minded



Performance-Driven



Customer-Focused