

## MX-A5062-MI6 Dual-Band Industrial Wireless Access Point

### Features

- Support IEEE 802.11a/b/g/n/ac
  - Maximum transfer rate 300Mbps (2.4G) & 867Mbps (5.8G)
  - Support wireless bridge and routing modes, which can flexibly deploy the network by adjusting the device network mode
  - Support intelligent QoS function, realize voice, video, and text's priority transmission through powerful text recognition, priority setting, and priority scheduling functions to meet various business needs
  - The system supports dual firmware switching between master and backup version, automatic synchronization backup of both parts, automatic detect & switch system failures function to enhance equipment stability and realizing automatic recovery from system failures
  - Support web management, making equipment installation and maintenance more convenient
  - Support wireless controller (AC) management, realize remote centralized configuration and upgrade management
  - Support 802.3af Protocol (POE)
  - Support ceiling-mounted and pole-mounted installation, suitable for installation in different area
  - Support Gigabit Ethernet port/SFP, adapt to multiple types of network access
  - The IP67 waterproof level ensure it can be suitable for a variety of environments
- \*Wireless controller needs to be purchased separately



### Description

MX-A6072-DI12 Outdoor WiFi6 High Performance Wireless Access Point supports the IEEE 802.11g/n/ac/ax protocol with a maximum rate of 1773.5Mbps, optimized bandwidth and network speed. Able to support multiple working modes of AP/Client to meet different application requirements.

It can be flexibly applied to different network access plans and supports wireless positioning functions to meet the requirements of underground pipelines, factories, industrial parks and related areas for smart wireless coverage. It supports seamless roaming technology with automatic detection and seamless switching to ensure users can enjoy the feelingless roaming under the signal coverage.

It can provide customers with a stable full-area outdoor wireless signal and ensure the good experience of stable, high-quality and convenient network services. It also incorporates several leading core achievements to make sure stable, reliable coverage and high-throughput performance in all scenes.

Its structural design fully considers the applications in extreme industrial environments and is designed to meet the IP67 waterproof standard, making it an ideal choice for industrial-grade Wi-Fi coverage equipment.

**MAXON**

*Link Of Your Think*

Nanjing MAXON O.E. TECH. CO., LTD

TEL: 86-25-86380932

WEB: [www.mxcomm.cn](http://www.mxcomm.cn)

E-MAIL: [info@maxon.com](mailto:info@maxon.com)

# Nanjing MAXON O.E. TECH. CO., LTD

Add: 6/F, Building A3, Zidong International Creative Park, Zidong Road, Qixia District, Nanjing, China.



## 25dBm high power

The highest output power can reach 25dBm, and the built-in omnidirectional 6dBi antenna brings excellent Wi-Fi signal coverage



## Positioning service

Support wireless probe function, docking with positioning server, which can meet the positioning requirements of smart underground pipeline and factory



## Multiple installation design

Flexible mounting design supports both ceiling and pole mounts



## Waterproof level IP67

The Waterproof level reaches IP67, suitable for a variety of environments



## 2x2 MIMO

Supports 2x2 MIMO standard



## High throughput

Maximum transfer rate 300Mbps (2G) & 867Mbps (5G)



## Gigabit Ethernet/Gigabit SFP

Supports Gigabit Ethernet/Gigabit SFP



## POE powered

Supports 100-meter Ethernet POE power supply, which is convenient for deployment and networking

## Specification

HARDWARE	Shell	Metal+PC
	Host size (mm)	262*194*72mm
	Net weight (kg)	1450g
	Installation method	ceiling installation (standard), pole-mounted installation (optional)
	Waterproof	IP67
	Antenna Gain	2.4G: 6dBi 5.8G: 6dBi
	Antenna Type	dual-band omnidirectional built-in antenna
	Power supply	48V 0.5A POE

# MAXON

Link Of Your Think

Nanjing MAXON O.E. TECH. CO., LTD

TEL: 86-25-86380932

WEB: [www.mxcomm.cn](http://www.mxcomm.cn)

E-MAIL: [info@maxonc.com](mailto:info@maxonc.com)

## Nanjing MAXON O.E. TECH. CO., LTD

Add: 6/F, Building A3, Zidong International Creative Park, Zidong Road, Qixia District, Nanjing, China.

HARDWARE	Maximum power consumption	12W
	Maximum transmit power	2.4G/2.4G: 25dBm; 5.8G: 24dBm
	Connector (WAN)	10/100/1000Mbps
	Connector (LAN)	10/100/1000Mbps or 1000Mbps SFP
	Key	1*Reset
	Indicator	1*power, 1*system, 1*2.4G, 1*5.8G
	Working temperature	-40℃~70℃/-40~158°F
	Storage temperature	-40℃~85℃/-40~185°F
	Working humidity	5%~95%RH non-condensing
	Surge immunity	POE/GE: common mode 4KV, differential mode 2KV
	Electrostatic discharge immunity	Contact discharge: 6KV, Air discharge: 8KV
	Mounting kit	2 x RJ45 M25 PG waterproof connector (optional SFP waterproof connector) 1 x Ceiling Mount Kit 1 x 48V 0.5A POE Adapter 1 x AC Power Cord 1 x Product Instruction Manual 1 x Product Certificate & Warranty Card
SOFTWARE	Protocol	802.11a/b/g/n/ac
	Maximum speed	1167Mbps (2.4G 300Mbps +5.8G 867Mbps)
	Frequency range	2.4G: 2412~2472MHz 5.8 G: 5180~5320MHz、5745~5825MHz
	Channel width	20/40/80MHz
	Working Mode	Access Point, Client, WDS Access Point, WDS Client
	Security Configuration	WPA2-PSK, Hidden SSID, IP/MAC Filtering
	Application mode	AP, Client
	Configuration management	support web configuration, support AC remote management, support SNMP management
	Ethernet software features	support IPv4/IPv6 dual protocol stack DHCP Server/Client, DNS, HTTP, IPv4, LLDP, Proxy ARP, SMTP, SNMP v2c/v3, Syslog, TCP/IP, SSH, UDP, VLAN

# MAXON

*Link Of Your Think*

Nanjing MAXON O.E. TECH. CO., LTD

TEL: 86-25-86380932

WEB: [www.mxcomm.cn](http://www.mxcomm.cn)

E-MAIL: [info@maxonc.com](mailto:info@maxonc.com)

## Nanjing MAXON O.E. TECH. CO., LTD

Add: 6/F, Building A3, Zidong International Creative Park, Zidong Road, Qixia District, Nanjing, China.

SOFTWARE	Dynamic frequency selection	support intelligent channel analysis & automatic optimal channel selection support 5.8GHz DFS
	Intelligent Bandwidth Rate Limiting	Support IP and MAC-based upstream and downstream rate limiting
	IoT expansion	reserved UART interface to support IoT application expansion such as Bluetooth, ZigBee, UWB, etc.
	Intelligent Bandwidth Rate Limiting	Support IP and MAC-based upstream and downstream rate limiting
	IoT expansion	reserved UART interface to support IoT application expansion such as Bluetooth, ZigBee, UWB, etc.
	Others	Scheduled restart, QoS, Watchdog
APPLICATION	Smart factories, enterprises, underground pipelines, industrial parks, scenic spot, education campus, digital warehouse wireless coverage	

### Dimensions



### Connector

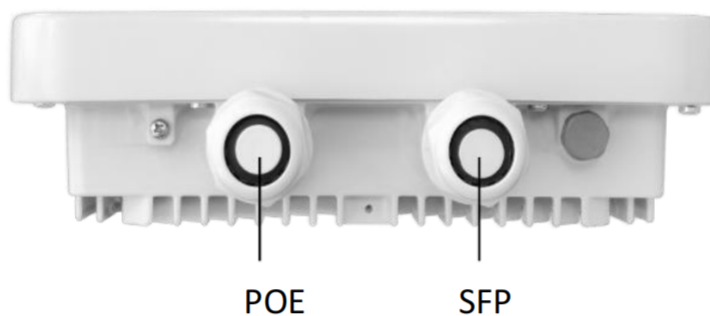

**MAXON**

*Link Of Your Think*

Nanjing MAXON O.E. TECH. CO., LTD

TEL: 86-25-86380932

WEB: [www.mxcomm.cn](http://www.mxcomm.cn)

E-MAIL: [info@maxonc.com](mailto:info@maxonc.com)

# Nanjing MAXON O.E. TECH. CO., LTD

Add: 6/F, Building A3, Zidong International Creative Park, Zidong Road, Qixia District, Nanjing, China.

## ceiling-mounted view

M3x8  
screws

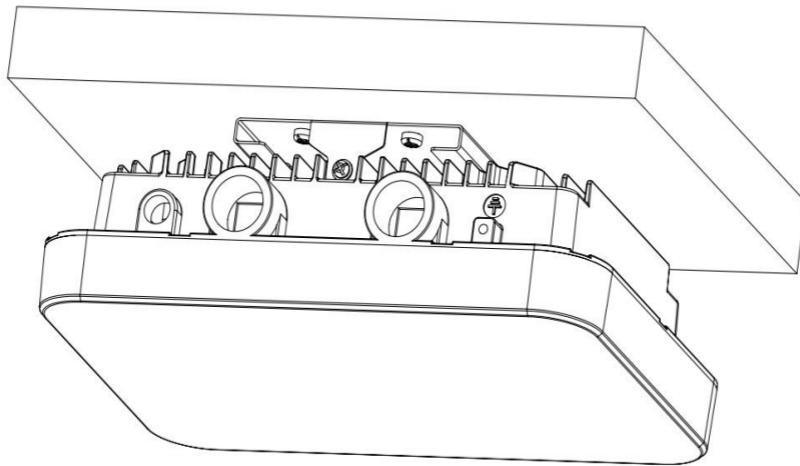
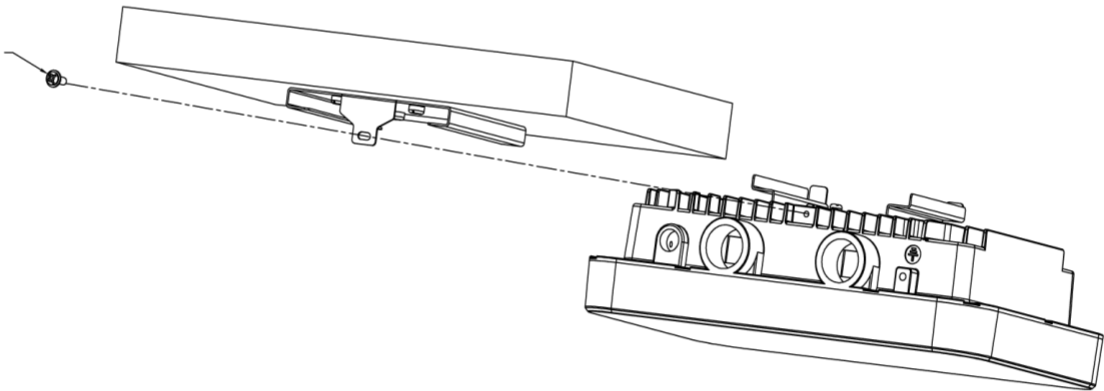

### Steps:

1. 4x M4x30 self-tapping screws to fix the ceiling bracket on the wall;
2. 4x M4x10 screws to fix the mounting bracket on the whole machine;
3. Push the whole machine with the mounting bracket installed along the guide groove of the ceiling bracket, and finally insert it to unmoveable and fix it with M3x8 screws.

---

# MAXON

*Link Of Your Think*

Nanjing MAXON O.E. TECH. CO., LTD

TEL: 86-25-86380932

WEB: [www.mxcomm.cn](http://www.mxcomm.cn)

E-MAIL: [info@maxonc.com](mailto:info@maxonc.com)



# Nanjing MAXON O.E. TECH. CO., LTD

Add: 6/F, Building A3, Zidong International Creative Park, Zidong Road, Qixia District, Nanjing, China.

## Antenna Radiation Pattern

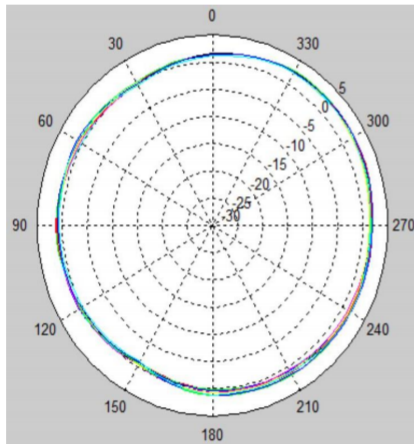

2.4G horizontal pattern

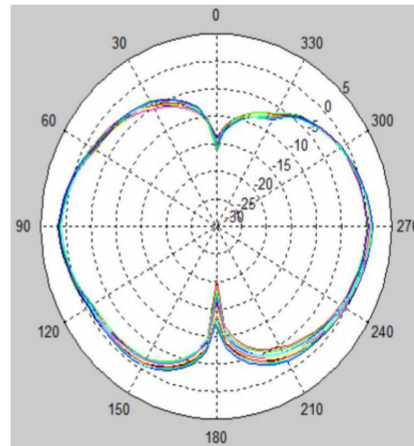

2.4G vertical pattern

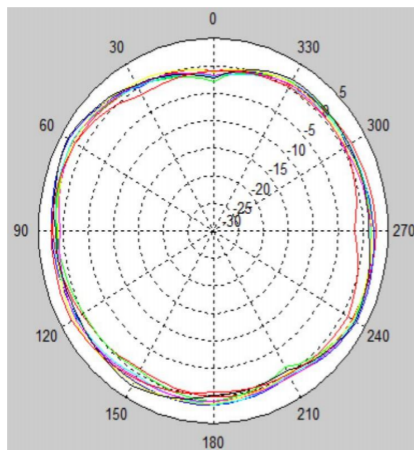

5.8G horizontal pattern

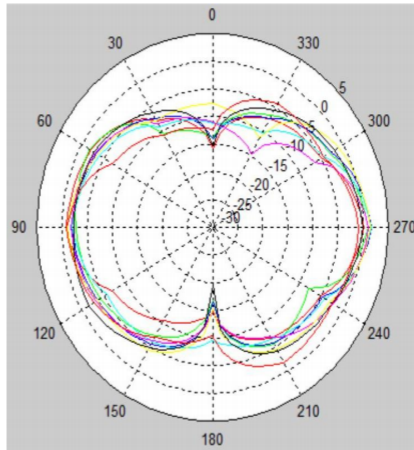

5.8G vertical pattern

**MAXON**

*Link Of Your Think*

Nanjing MAXON O.E. TECH. CO., LTD

TEL: 86-25-86380932

WEB: [www.mxcomm.cn](http://www.mxcomm.cn)

E-MAIL: [info@maxonc.com](mailto:info@maxonc.com)