

## VOICE BAND INVERTER

### FEATURES:

- CTCSS Compatible
- Automatic Private/Clear Switching
- Fixed Frequency Inversion
- $\mu$ P Compatible Interface
- Choice of Audio Bandwidths
- Low Power CMOS

### APPLICATIONS:

- Land Mobile Radio
- Community Repeaters
- Interconnect Systems
- Voice Filtering

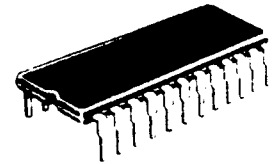

MX004J (CDIP)  
MX004P (PDIP)  
24 Pins

### CIRCUIT DESCRIPTION:

The MX004 Voice Band Inverter ensures private voice communications for land mobile radio and other shared channel radio systems. Designed for use in half-duplex systems, the MX004 exchanges high and low frequencies in the voice band and renders transmitted messages unintelligible.

Sharp cut-off in the internal voice band filters permits operation with CTCSS and similar sub-audio signaling schemes and ensures high quality recovered audio.

The MX004 incorporates a programmable clock divider which controls the carrier and filter cut-off frequencies. A pilot tone generator and detector are used to operate the automatic clear/private facility in mixed equipment systems. Control of the  $R_x/T_x$ , PTL and privacy functions is by pin selection or use of serial/parallel microprocessor interfaces.

The MX004 operates from a single 5V supply and uses a 1 MHz crystal oscillator to ensure the correct pitch in recovered speech. Signal coupling and supply decoupling are the only external components needed.

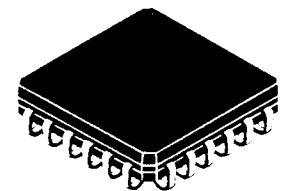

MX004LH  
(24p PLCC)

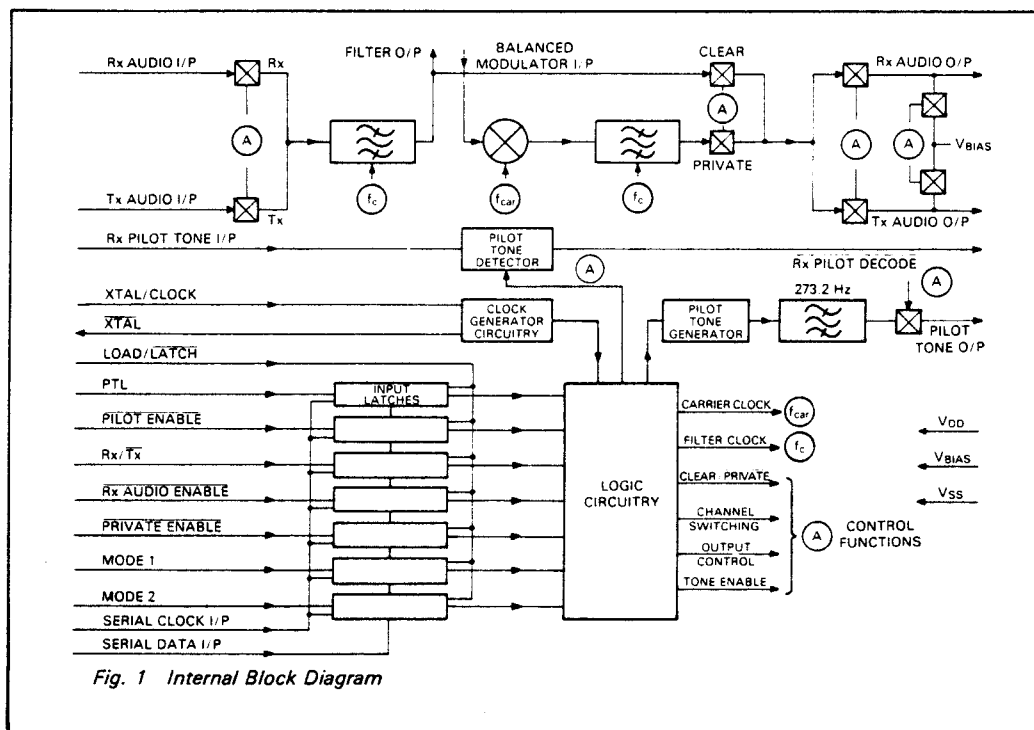

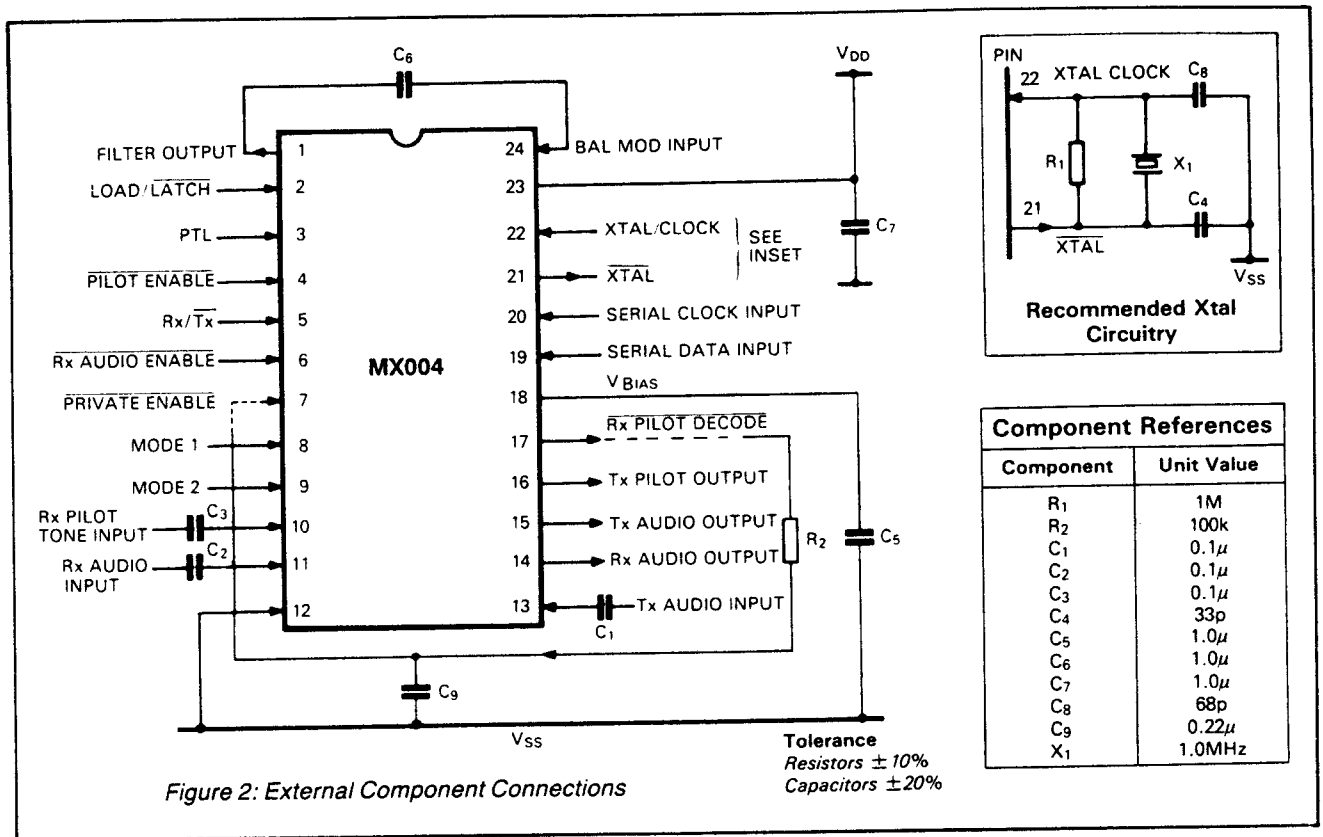

### PRIVATE ENABLE (AUTO-CLEAR)

To minimize the effect of noise and signal strength fluctuations on the "Auto-Clear" function, the use of external integrating components between the  $R_x$  Pilot Decode output and the Private Enable input is required. Components  $R_2$  and  $C_9$ , having a time constant of 20 ms  $\pm$  12 ms, are recommended, as shown in Fig. 2.

### AUDIO QUALITY

If it is necessary to install the MX004 Voice Band Inverter before the transmitter's existing pre-emphasis stage, an additional pre-emphasis stage before the MX004, followed by a de-emphasis stage after the MX004, will enhance the audio quality. See the "Inversion Security Devices" application note for further details.

Input and Output Pin Conditions									
$R_x/T_x$	PTL	Private Enable	Pilot Enable	Rx Audio Enable	Assumed Rx I/P	Tx I/P	Rx O/P	Tx O/P	Tx Pilot O/P
1	0	X	X	1	X	X	$V_{DD}/2$	$V_{DD}/2$	O/C
1	1	X	X	1	Signal	X	Non Inverted	$V_{DD}/2$	O/C
1	X	0	X	0	Frequency Inverted	X	Clear (Passband Invert)	$V_{DD}/2$	O/C
1	X	1	X	0	Clear	X	Clear	$V_{DD}/2$	O/C
0	X	1	1	X	X	Signal	$V_{DD}/2$	Clear (Passband Non-Invert)	O/C
0	X	1	0	X	X	Signal	$V_{DD}/2$	Clear (Passband Non-Invert)	Tone
0	X	0	0	X	X	Signal	$V_{DD}/2$	Inverted (Passband Invert)	Tone
0	X	0	1	X	X	Signal	$V_{DD}/2$	Inverted (Passband Invert)	O/C

**Table 1 Control Truth Table** (X = don't care)

## MX004 PIN FUNCTION TABLE

### PIN NUMBER (ALL PKGS)

### FUNCTION

- |    |  |
|----|--|
| 1  | <b>Filter Output:</b> This is the audio bandpass filtered signal and is coupled externally to the Balanced Modulator input pin via capacitor $C_6$ . See Fig. 2.   |
| 2  | <b>Load/Latch:</b> This pin is used for controlling input latches in both Parallel and Serial loading modes. In Parallel, a logic "1" makes the latches transparent and the following inputs operate directly: PTL, PILOT ENABLE, $R_x/\overline{T_x}$ , $R_x$ AUDIO ENABLE, PRIVATE ENABLE, MODE 1 and MODE 2. When at logic "0," the data present is latched in. During Serial loading, LOAD/LATCH should be kept low until data is completely loaded. The new data is then latched in by strobing this pin 0-1-0. Internal 1 M $\Omega$ pullup. See Fig. 4. |
| 3  | <b>PTL:</b> A logic "1" level at this input enables the Audio Output in $R_x$ mode when $R_x$ AUDIO ENABLE is at logic "1." This feature enables channel checking without intercepting a private conversation. Internal 1 M $\Omega$ pullup.   |
| 4  | <b>Pilot Enable:</b> A logic "0" at this input enables the 273.2 Hz pilot tone at the $T_x$ PILOT TONE OUTPUT when in $T_x$ mode. Internal 1 M $\Omega$ pullup.  |
| 5  | <b><math>R_x/\overline{T_x}</math>:</b> This input selects the receive or transmit operating mode. Logic "1" is $R_x$ , logic "0" is $T_x$ . Internal 1 M $\Omega$ pullup.   |
| 6  | <b><math>R_x</math>Audio Enable:</b> A logic "0" at this input enables the $R_x$ Audio path in $R_x$ mode. May be connected to a CTCSS decoder. Internal 1 M $\Omega$ pullup.  |
| 7  | <b>Private Enable:</b> This input controls the input action of the balanced modulator by switching the carrier clock (refer to Table 1). When audio signals are inverted, the signal path gain is adjusted automatically to compensate for the upper sideband loss. Internal 1 M $\Omega$ pullup. For an "Auto-Clear" function, this input should be connected to the $R_x$ Pilot Decode pin via external integrating components $R_2$ and $C_9$ . See Fig. 2.   |
| 8  | <b>Mode 1:</b> These two inputs control audio band frequency, carrier frequency, and loading control   |
| 9  | <b>Mode 2:</b> mode. See Table 2. Internal 1 M $\Omega$ pullups.   |
| 10 | <b><math>R_x</math> Pilot Tone Input:</b> This pin is the input to the $R_x$ pilot tone decoder. Signals should be A.C. coupled. See Fig. 2. The tone decoder is disabled in $T_x$ mode.   |
| 11 | <b><math>R_x</math> Audio Input:</b> This is the audio input pin in $R_x$ mode. Signals should be A.C. coupled. See Fig. 2.  |
| 12 | <b><math>V_{ss}</math>:</b> Negative Supply (GND)  |
| 13 | <b><math>T_x</math> Audio Input:</b> This is the audio input pin in $T_x$ mode (mic). Signals should be A.C. coupled. See Fig. 2.  |
| 14 | <b><math>R_x</math> Audio Output:</b> This is the audio output in $R_x$ mode, internally biased at $V_{DD}/2$ in $T_x$ mode.   |
| 15 | <b><math>T_x</math> Audio Output:</b> This is the audio output in $T_x$ mode, internally biased at $V_{DD}/2$ when $T_x$ mode is selected.   |

## MX004 PIN FUNCTION TABLE (cont.)

### PIN NUMBER (ALL PKGS)

### FUNCTION

- 16 **T<sub>x</sub> Pilot Tone Output:** This pin outputs the 273.2 Hz pilot tone and would normally be summed with the T<sub>x</sub> Audio Output to modulate the transmitter. When not enabled or in R<sub>x</sub>, this output is open circuit (high impedance).
- 17 **R<sub>x</sub> Pilot Decode:** This pin is the output of the pilot tone detector. It outputs a logic "0" when a valid 273.2 Hz tone is input. Has high impedance load to V<sub>DD</sub> for wired "OR" connection to other pins. For an "Auto-Clear" function, this input should be connected to the Private Enable pin via external integrating components R<sub>2</sub> and C<sub>9</sub>. See Fig. 2.
- 18 **V<sub>BIAS</sub>:** This is the bias pin and is set internally to V<sub>DD</sub>/2. It should be externally decoupled using a capacitor of 1.0μF minimum to V<sub>SS</sub>. See Fig. 2.
- 19 **Serial Data Input:** Data present at this input is clocked into the input register by the "0-1" clock transition of the Serial Clock Input. See Fig. 4. Internal 1 MΩ pullup.
- 20 **Serial Clock Input:** The timing clock pulses for serial loading are input here. Internal 1 MΩ pullup.
- 21 **Xtal:** Output of the clock oscillator inverter.
- 22 **Xtal/Clock:** This is the input to the clock oscillator inverter. 1 MHz Xtal input or externally derived clock can be injected into this input.
- 23 **V<sub>DD</sub>:** Positive Supply. A single +5V power supply is required.
- 24 **Balanced Modulator Input:** This pin should be connected to the filter output pin via capacitor C<sub>6</sub> (See Fig. 2). It is internally biased at V<sub>DD</sub>/2.

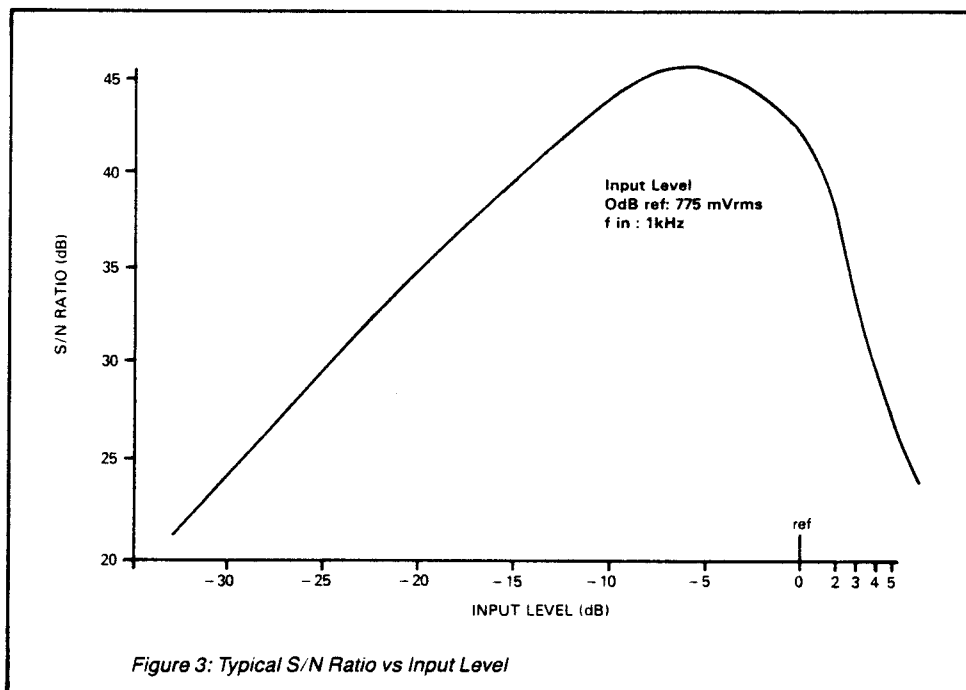

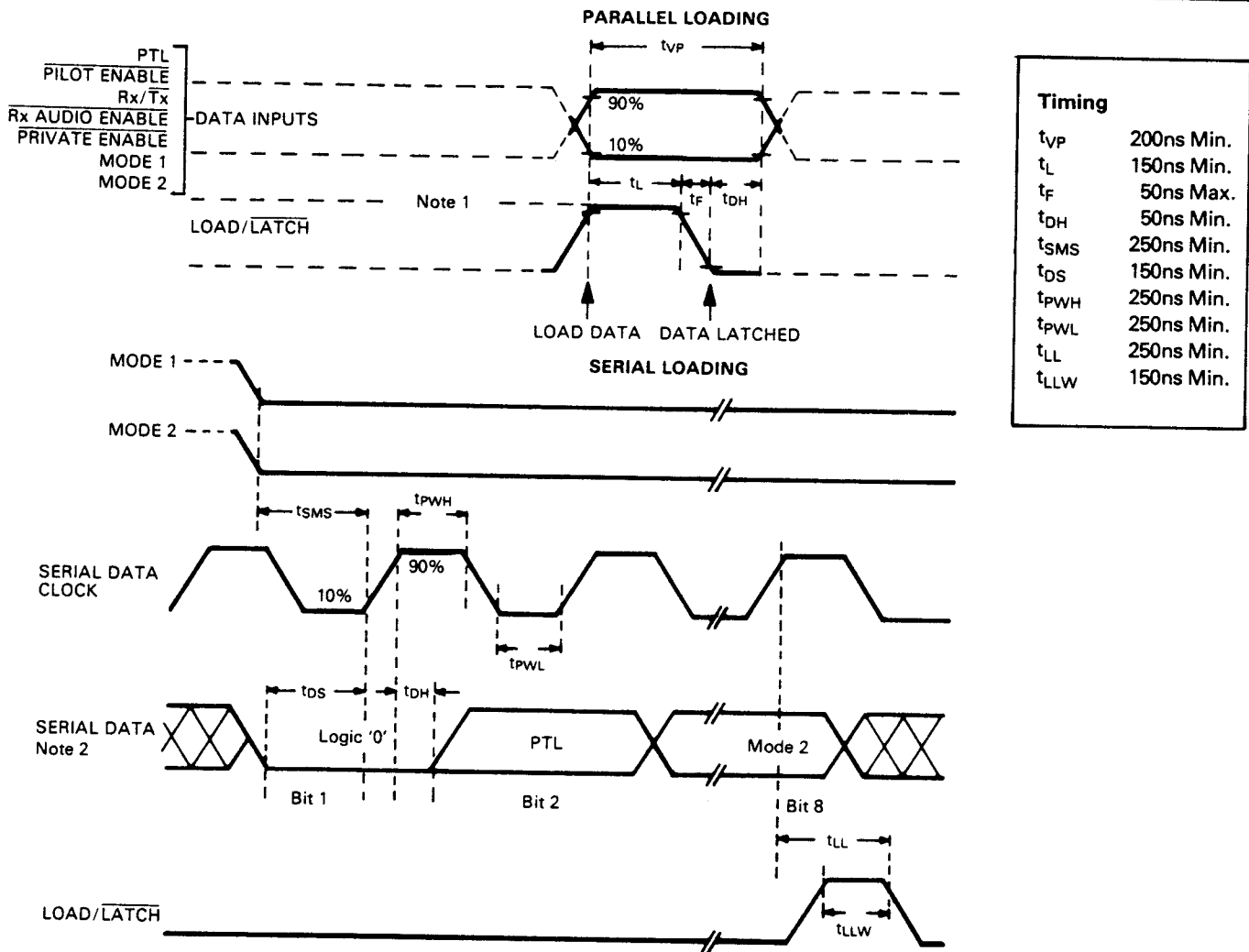

- NOTES:** 1. With  $\overline{LOAD/LATCH}$  at Logic '1' latches are transparent and data acts directly.  
 2. Serial Data Loading Sequence: – Logic '0' –  $\overline{PTL}$  –  $\overline{PILOT\ ENABLE}$  –  $Rx/\overline{Tx}$  –  $Rx\ AUDIO\ ENABLE$  –  $\overline{PRIVATE\ ENABLE}$  – MODE 1 – MODE 2.

Fig. 4 Loading Timing Diagrams

Parallel Loading Mode						Serial Loading Mode		
Mode 1 I/P	Mode 2 I/P	Audio Band-Freq. (Hz)	Carrier Freq. (Hz)	Divisor ( $f_{clk/x}$ )	Control Mode	Serial Data In Bit 7	Serial Data In Bit 8	Audio Band
0	1	C 273 – 2757	3030	X = 330	Parallel	0	1	C
1	0	A 333 – 3370	3703	X = 270	Parallel	1	0	A
1	1	B 300 – 3033	3333	X = 300	Parallel	1	1	B
0	0	–	–	–	Serial	0	0	B

**Audio Bands**

The audio band/modulation frequency relationships with their division ratios are shown in Table 2 and are produced with a  $X_{tal}$ /clock frequency ( $f_{clk}$ ) of 1MHz. The modulation frequency and band limits will alter proportionally with  $X_{tal}$  frequency.

Table 3 Bandwidths						
Audio Band	Stopband @ $\geq -42$ dB. F max	Passband		Attenuation at Carrier Frequency		Stopband @ $\geq -42$ dB. F min.
A	278Hz	333Hz	3370Hz	3703Hz	20dB	4036Hz
B	250Hz	300Hz	3033Hz	3333Hz	20dB	3633Hz
C	227Hz	273Hz	2757Hz	3030Hz	20dB	3302Hz

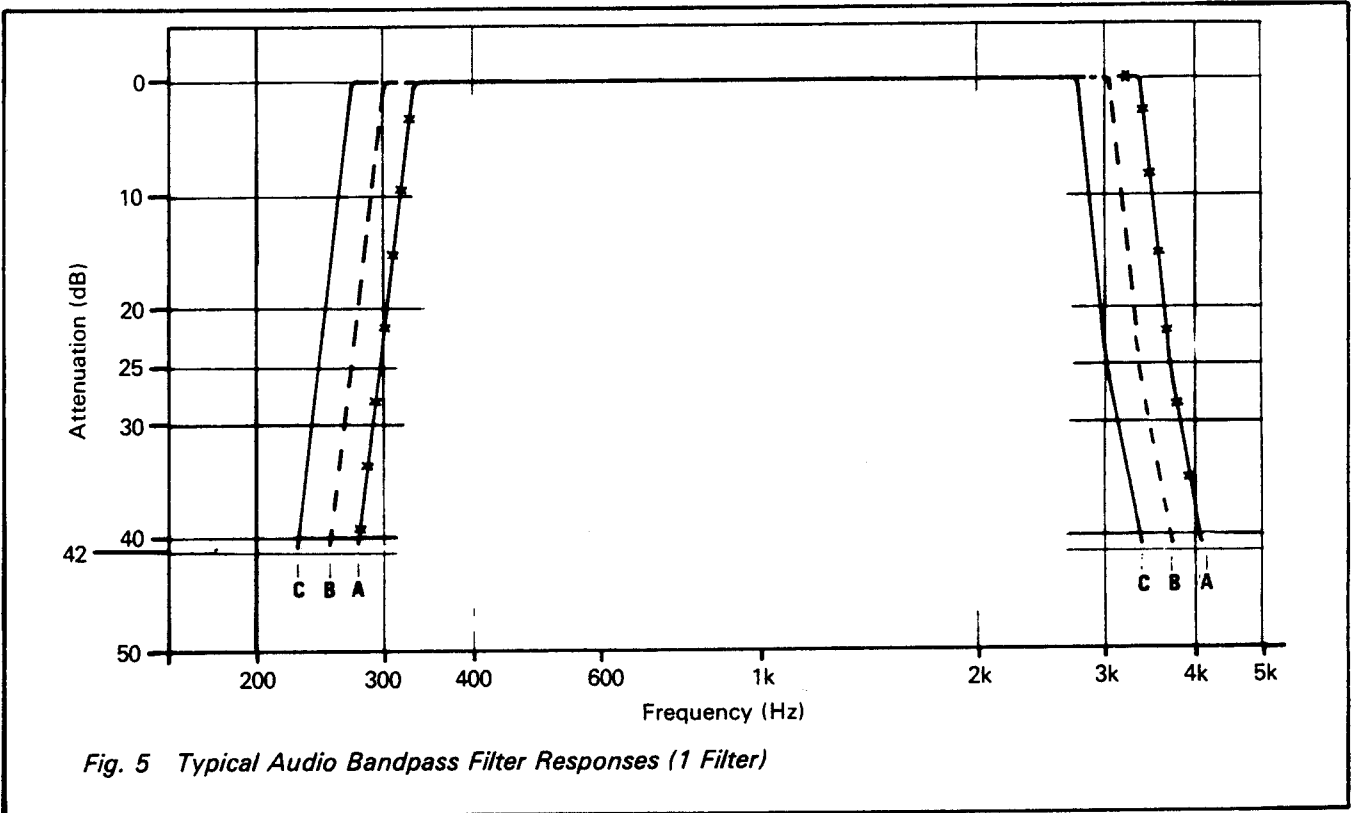

Fig. 5 Typical Audio Bandpass Filter Responses (1 Filter)

# MX004 ELECTRICAL SPECIFICATION

## Absolute Maximum Ratings

Exceeding the maximum rating can result in device damage. Operation of the device outside the operating limits is not implied.

Supply voltage		- 0.3V to 7.0V
Input voltage at any pin (ref. $V_{SS} = 0V$ )		- 0.3V to ( $V_{DD} + 0.3V$ )
Output sink/source current (supply pins)		$\pm 30mA$
(other pins)		$\pm 20mA$
Total Device Dissipation ( $\alpha$ 25°C)		800mW Max.
Derating		10mW°C
Operating Temperature Range:	MX004J	- 30°C + 85 °C (Ceramic)
	MX004P,LH	- 30°C + 70°C (Plastic)
Storage Temperature Range:	MX004J	- 55°C to + 125° (Ceramic)
	MX004P,LH	- 40° to + 85°C (Plastic)

## Operating Limits:

All characteristics measured using the following parameters unless otherwise specified:

$V_{DD} = 5V$ ,  $T_{amb} = 25^\circ C$ , Clock 1 MHz, Audio Level Ref: 0dB = 775 mVrms.

Characteristics	See Note	Min	Typ	Max	Unit
<b>Static Values</b>					
Supply Voltage	1	4.5	5.0	5.5	V
Supply Current		—	8.0	—	mA
Audio Input Impedance		—	500	—	k $\Omega$
Audio Output Impedance		—	500	—	$\Omega$
Logic Input Impedance		—	1.0	—	M $\Omega$
Logic Output Impedance		—	100	—	k $\Omega$
( $R_x$ Pilot Decode) To $V_{DD}$		—	500	—	$\Omega$
To $V_{SS}$		—	—	—	—
Input Logic "1"	1	3.5	—	—	V
Input Logic "0"	1	—	—	1.5	V
Output Logic "1"	1	4	—	—	V
Output Logic "0"	1	—	—	1	V
<b>Dynamic Values</b>					
Audio Input Levels $R_x/T_x$	8	—	- 8	—	dB
Audio Output Levels $R_x/T_x$		—	- 8	—	dB
<b>Audio Bandpass Filtter (in clear):</b>					
Passband Frequencies Band A	2	333	—	3370	Hz
Passband Frequencies Band B	2	300	—	3033	Hz
Passband Frequencies Band C	2	273	—	2757	Hz
Passband Gain	5	—	0	—	dB
Passband Ripple	5	—	+/-1	—	dB
Output Noise Level	3	—	-51	—	dB
Insertion Loss		—	0	—	dB
Total Harmonic Distortion	9	—	2	5	%

## MX004 ELECTRICAL SPECIFICATION (CONT.)

Characteristics	See Note	Min	Typ	Max	Unit
<b>Pilot Tone Detector</b>					
Sensitivity		—	13	—	mVrms
Response Time	6	—	50	—	ms
Talk off and Falsing	4				
<b>Pilot Tone Output</b>					
Tone Output Level		-2	0	+2	dB
Distortion		—	—	5	%
Tone Frequency	7	—	273.2	—	Hz
<b>Parallel/Serial Inputs (Fig. 4)</b>					
Parallel Set-up Time $t_{SP}$		400	—	—	ns
Load/Latch Pulse Width $t_1$		400	—	—	ns
Serial Clock Pulse Width $t_c$		400	—	—	ns
Serial Set-up Time $t_{SS}$		400	—	—	ns
Serial Data Clock Frequency		—	1	—	MHz

**Notes:** 1. Characteristics specified at 5V  $V_{DD}$ .

2. Bandpass limits at -1 dB of mean passband level.

3. Measured at the  $R_x$  audio output in Private with  $R_x$  audio input A.C. short circuit.

4. Talk off: For 30 mV pilot tone (273 Hz), 5 kHz white noise at -3dB on tone, 1 drop out per minute is expected. Typically 5 ms/drop out.

Falsing: For 380 mVrms (not clipping), 5 MHz white noise, 25 falses per minute are expected (10ms/false). Measured without integration components.

5. All bandpass filters display similar performances. See Figure 5.

6. Tested with composite signal of 300 mVrms, 1 kHz tone. Pilot tone of 30 mVrms in white noise of 5kHz at 75 mVrms.

7. Accurate  $T_x$  only

8. See figure 3 with respect to signal noise ratio.

9. For -3 dB, 1 kHz input.





**CML Microcircuits**

COMMUNICATION SEMICONDUCTORS

## CML Product Data

In the process of creating a more global image, the three standard product semiconductor companies of CML Microsystems Plc (*Consumer Microcircuits Limited (UK)*, *MX-COM, Inc (USA)* and *CML Microcircuits (Singapore) Pte Ltd*) have undergone name changes and, whilst maintaining their separate new names (*CML Microcircuits (UK) Ltd*, *CML Microcircuits (USA) Inc* and *CML Microcircuits (Singapore) Pte Ltd*), now operate under the single title **CML Microcircuits**.

These companies are all 100% owned operating companies of the CML Microsystems Plc Group and these changes are purely changes of name and do not change any underlying legal entities and hence will have no effect on any agreements or contacts currently in force.

### CML Microcircuits Product Prefix Codes

Until the latter part of 1996, the differentiator between products manufactured and sold from MXCOM, Inc. and Consumer Microcircuits Limited were denoted by the prefixes MX and FX respectively. These products use the same silicon etc. and today still carry the same prefixes. In the latter part of 1996, both companies adopted the common prefix: CMX.

This notification is relevant product information to which it is attached.

### CML Microcircuits (USA) [formerly MX-COM, Inc.] Product Textual Marking

On CML Microcircuits (USA) products, the '**MX-COM**' textual logo is being replaced by a '**CML**' textual logo.

Company contact information is as below:



**CML Microcircuits  
(UK) Ltd**

COMMUNICATION SEMICONDUCTORS

Oval Park, Langford, Maldon,  
Essex, CM9 6WG, England  
Tel: +44 (0)1621 875500  
Fax: +44 (0)1621 875600  
uk.sales@cmlmicro.com  
www.cmlmicro.com



**CML Microcircuits  
(USA) Inc.**

COMMUNICATION SEMICONDUCTORS

4800 Bethania Station Road,  
Winston-Salem, NC 27105, USA  
Tel: +1 336 744 5050,  
0800 638 5577  
Fax: +1 336 744 5054  
us.sales@cmlmicro.com  
www.cmlmicro.com



**CML Microcircuits  
(Singapore) Pte Ltd**

COMMUNICATION SEMICONDUCTORS

No 2 Kallang Pudding Road, 09-05/  
06 Mactech Industrial Building,  
Singapore 349307  
Tel: +65 7450426  
Fax: +65 7452917  
sg.sales@cmlmicro.com  
www.cmlmicro.com