



McIntosh Laboratory, Inc. 2 Chambers Street Binghamton, New York 13903-2699 Phone: 607-723-3512 www.mcintoshlabs.com

MX121
A/V Control Center
Owner's Manual



The lightning flash with arrowhead, within an equilateral triangle, is intended to alert the user to the presence of uninsulated “dangerous voltage” within the product’s enclosure that may be of sufficient magnitude to constitute a risk of electric shock to persons.

WARNING - TO REDUCE RISK OF FIRE OR ELECTRICAL SHOCK, DO NOT EXPOSE THIS EQUIPMENT TO RAIN OR MOISTURE.



AVIS RISQUE DE CHOC ELECTRIQUE - NE PAS OUVRIR.

NO USER-SERVICEABLE PARTS INSIDE. REFER SERVICING TO QUALIFIED PERSONNEL.

The exclamation point within an equilateral triangle is intended to alert the user to the presence of important operating and maintenance (servicing) instructions in the literature accompanying the appliance.

To prevent the risk of electric shock, do not remove cover or back. No user-serviceable parts inside.

IMPORTANT SAFETY INSTRUCTIONS!

PLEASE READ THEM BEFORE OPERATING THIS EQUIPMENT.

1. Read these instructions.
2. Keep these instructions.
3. Heed all warnings.
4. Follow all instructions.
5. Do not use this apparatus near water.
6. Clean only with a dry cloth.
7. Do not block any ventilation openings. Install in accordance with the manufacturer’s instructions.
8. Do not install near any heat sources such as radiators, heat registers, stoves, or other apparatus (including amplifiers) that produce heat.
9. Do not defeat the safety purpose of the polarized or grounding-type plug. A polarized plug has two blades with one wider than the other. A grounding type plug has two blades and a third grounding prong. The wide blade or the

third prong are provided for your safety. If the provided plug does not fit into your outlet, consult an electrician for replacement of the obsolete outlet.

10. Protect the power cord from being walked on or pinched particularly at plugs, convenience receptacles, and the point where they exit from the apparatus.
11. Only use attachments/accessories specified by the manufacturer.
12. Use only with the cart, stand, tripod, bracket, or table specified by the manufacturer, or sold with the apparatus. When a cart is used, use caution when moving the cart/apparatus combination to avoid injury from tip-over.
13. Unplug this apparatus during lightning storms or when unused for long periods of time.
14. Refer all servicing to qualified service personnel. Servicing is required when the apparatus has been damaged in any way, such as power-supply cord or plug is damaged, liquid has



been spilled or objects have fallen into the apparatus, the apparatus has been exposed to rain or moisture, does not operate normally, or has been dropped.



15. Do not expose this equipment to dripping or splashing and ensure that no objects filled with liquids, such as vases, are placed on the equipment.
16. To completely disconnect this equipment from the a.c. mains, disconnect the power supply cord plug from the a.c. receptacle.
17. The mains plug of the power supply cord shall remain readily operable.
18. Do not expose batteries to excessive heat such as sunshine, fire or the like.
19. Connect mains power supply cord only to a mains socket outlet with a protective earthing connection.
20. **Warning: The Ethernet connector of this equipment must not be directly connected to a public network. Connection is to be made only by way of a modem or router approved for this purpose.**

Trademark and License Information

The McIntosh MX121 incorporates copyright protected technology that is protected by U.S. patents and other intellectual property rights. The MX121 uses the following Technologies:

This item incorporates copy protection technology that is protected by U.S. patents and other intellectual property rights of Rovi Corporation. Reverse engineering and disassembly are prohibited.

PANDORA, the PANDORA logo, and the Pandora trade dress are trademarks or registered trademarks of Pandora Media, Inc. Used with permission.

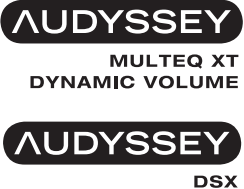
Trademark Logo	License Information
	AirPlay®, the AirPlay logo, iPhone®, iPod®, iPod classic®, iPod nano®, iPod shuffle®, iPod touch® and iPad® are trademarks of Apple Inc., registered in the U.S. and other countries.
	<p>“Made for iPod” and “Made for iPhone” mean that an electronic accessory has been designed to connect specifically to iPod or iPhone respectively, and has been certified by the developer to meet Apple performance standards.</p> <p>Apple is not responsible for the operation of this device or its compliance with safety and regulatory standards. Please note that the use of this accessory with iPod, or iPhone, may affect wireless performance.</p> <ul style="list-style-type: none"> •iPhone, iPod, iPod classic, iPod nano, iPod shuffle and iPod touch are trademarks of Apple Inc., registered in the U.S. and other countries. <p>Individual users are permitted to use iPhone, iPod, iPod classic, iPod nano, iPod shuffle, and iPod touch for private copy and playback of non-copyrighted contents and contents whose copy and playback is permitted by law. Copyright infringement is prohibited by law.</p>
	Manufactured under license from Audyssey Laboratories. U.S. and foreign patents pending. Audyssey MultEQ® XT, Audyssey Dynamic EQ®, Audyssey Dynamic Volume® and Audyssey DSX® are registered trademarks of Audyssey Laboratories.

Trademark Logo	License Information
	DLNA®, the DLNA Logo and DLNA CERTIFIED® are trademarks, service marks, or certification marks of the Digital Living Network Alliance. Device Class: DMP (Digital Media Player) DLNA Certified® Product Function: FINDS, PLAYS Content Type: audio, images, videos (Check supported media formats.) DLNA consumer website: www.dlna.org Some content may not be compatible with other DLNA Certified® products (example: optional media formats)
	Manufactured under license from Dolby Laboratories. Dolby, Pro Logic and the double-D symbol are trademarks of Dolby Laboratories.
	Manufactured under license under U.S. Patent Nos: 5,956,674; 5,974,380; 6,226,616; 6,487,535; 7,212,872; 7,333,929; 7,392,195; 7,272,567 & other U.S. and worldwide patents issued & pending. DTS-HD, the Symbol, & DTS-HD and the Symbol together are registered trademarks & DTS-HD Master Audio is a trademark of DTS, Inc. Product includes software. © DTS, Inc. All Rights Reserved.
	Manufactured under license from DTS Licensing Limited. DTS, the Symbol, & DTS and the Symbol together are registered trademarks & DTS Neural Surround is a trademark of DTS, Inc. Product includes software. © DTS, Inc. All Rights Reserved.
	HDMI, the HDMI Logo and High-Definition Multimedia Interface are trademarks or registered trademarks of HDMI Licensing LLC in the United States and other countries.



Thank You

Your decision to own this McIntosh MX121 A/V Control Center ranks you at the very top among discriminating music listeners. You now have “The Best.” The McIntosh dedication to “Quality,” is assurance that you will receive many years of musical enjoyment from this unit.

Please take a short time to read the information in this manual. We want you to be as familiar as possible with all the features and functions of your new McIntosh.

Please Take A Moment

The serial number, purchase date and McIntosh Dealer name are important to you for possible insurance claim or future service. The spaces below have been provided for you to record that information:

Serial Number: _____

Purchase Date: _____

Dealer Name: _____

Technical Assistance

If at any time you have questions about your McIntosh product, contact your McIntosh Dealer who is familiar with your McIntosh equipment and any other brands that may be part of your system. If you or your Dealer wish additional help concerning a suspected problem, you can receive technical assistance for all McIntosh products at:

McIntosh Laboratory, Inc.
2 Chambers Street
Binghamton, New York 13903
Phone: 607-723-3512
Fax: 607-724-0549

Customer Service

If it is determined that your McIntosh product is in need of repair, you can return it to your Dealer. You can also return it to the McIntosh Laboratory Service Department. For assistance on factory repair return procedure, contact the McIntosh Service Department at:

McIntosh Laboratory, Inc.
2 Chambers Street
Binghamton, New York 13903
Phone: 607-723-3515
Fax: 607-723-1917

Table of Contents

Safety Instructions	2
Trademark and License Information	3
Thank You and Please Take a Moment.....	4
Technical Assistance and Customer Service	4
Table of Contents	4
General Information	5
Connector and Cable Information	6
Introduction.....	7
Performance Features	7
Dimensions	8
Installation	9

Connections:

Rear Panel Connections.....	10
Connections Diagram (Separate Sheet).....	Mc1A
MX121 Main Zone Input Connections	11
Connection Diagram (Separate Sheet)	Mc2A
MX121 Main Zone Output Connections	12
Connection Diagram (Separate Sheet)	Mc2B
MX121 Zone 2 Input and Output Connections.....	13
Connection Diagram (Separate Sheet)	Mc3A, 3B

Copyright 2012 © by McIntosh Laboratory, Inc.

Front Panel:

Front Panel Displays, Controls and Push-buttons... 147	
Diagram (Separate Sheet).....	Mc1B

Remote Control:

Remote Control.....	15
Push-buttons Functioning (Separate Sheet)...	Mc4A, 4B

Setup Mode:

Introduction to the MX121 Setup Mode	16
Audyssey Auto Setup.....	17-20
Network Settings and Functions.....	21-23
Trigger Settings and Option Settings.....	23
Input Connections, Re-Naming and	
Amplifier Assignment	24
Manual Speaker Setup	25
HDMI, Zone 2 and Zone 3 Setup	26
Picture Adjust and IR Sensor Setting	27
Video Input, Input Mode Setup	28
Input Source Level, Audio Setup and	
Manual Equalization.....	29-30
Surround Parameter.....	30

Operation:

How to Operate the MX121	32-49
Audyssey Adjustments	37-38
iPod Playback and AirPlay	38-39
USB Drive Playback	40
Accessing the Internet and McIntosh Radio	42-43
Pandora	44-45
Last.fm.....	46-47
Flickr.....	48
Resetting the Micro and Updating Firmware.....	49

Additional Information:

Specifications.....	50
Packing Instruction.....	51

General Information

1. For additional connection information, refer to the owner’s manual(s) for any component(s) connected to the MX121 A/V Control Center.
2. The Main AC Power going to the MX121 and any other McIntosh Component(s) should not be applied until all the system components are connected together. Failure to do so could result in malfunctioning of some or all of the system’s normal operations. When the MX121 and other McIntosh Components are in their Standby Power Off Mode, the Microprocessor’s Circuitry inside each component is active and communication is occurring between them.
3. Sound Intensity is measured in units called Decibels and “dB” is the abbreviation.
4. LFE (Low Frequency Effects) refers to the Dolby Digital or DTS sound channel dedicated to sound effects (such as explosions) and is usually reproduced by the Subwoofer.
5. When discarding the unit, comply with local rules or regulations. Batteries should never be thrown away or incinerated but disposed of in accordance with the local regulations concerning battery disposal.
6. For additional information on the MX121 and other McIntosh Products please visit the McIntosh Web Site at www.mcintoshlabs.com.
7. The Main Zone accepts Audio Input Signals from the HDMI, iPod/USB, Coaxial/Optical Digital and unbalanced/balanced Analog Input Connections.
8. The Zones 2 and 3 accept Audio Input Signals from the iPod/USB, Coaxial/Optical PCM Digital Signals and unbalanced/balanced Analog Input Connections.



Note: When connecting source devices with HDMI

Outputs to the MX121, make sure to also connect the unbalanced/balanced Analog Output or Coaxial/Optical Digital Audio Output for each HDMI Source connected to MX121.

9. The Main Zone accepts Video Input Signals from the HDMI, Component Video and Composite Video Input Connections.
10. Zone 2 accepts Video Input Signals from the Component Video and Composite Video Input Connections.
11. Zone 3 is for Audio Signal Sources only.
12. MX121 is a three Zone Product (Main Zone, Zone 2 and Zone 3). This allows two different Audio/Video Sources to be available simultaneously for two separate rooms. Zone 2 may be used to provide an Audio/Video Output Signal for recording purposes, instead of an A/V signal to a second room. The Zone 3 allows for listening to a different Audio Source from either the Main Zone or Zone 2. For more information contact your McIntosh Dealer or McIntosh Technical Support.
13. The IR Input with 1/8 inch mini phone jack is compatible IR sensors such as a Xantech Model HL85BK Kit. Use a Connection Block such as a Xantech Model ZC21 when two or more IR sensors need to be connected to the MX121. To avoid possible interaction, disable the MX121 Front Panel Sensor. Refer to “IR Sensor” on page 27.
14. Setup Mode operations should be performed in the order they appear in the first Setup Menu presented, as they are interactive.
15. To hear bass frequencies below 80Hz, your system must include either a Subwoofer or Large Front Loudspeakers.
16. The MX121 has built-in HDMI Digital Video Selection and Digital Video Processing Circuitry with scaling capabilities to convert Composite or

Component Video Signals to Digital Video.

17. When there is a connection between the HDMI Output and a TV/Monitor, the On-Screen Overlays including Menus, will only appear on the HDMI Output.
18. HDMI Cable lengths between source components and the MX121 also between the MX121 and the TV/Monitor, should not exceed 25ft (8.3m). If there is need to use HDMI Cables longer than 25ft (8.3m) a high quality in line HDMI Buffer/Converter would be required for reliable digital signal transmission via the HDMI Connections.
19. The MX121 is designed to pass through a 3D Digital Video Signal from a source component to a 3D TV/Monitor via the HDMI Connections. It is extremely important the HDMI cables used for connections meet or exceed the HDMI High Speed Cable Standards (1.4a) for proper 3D Video Playback.
20. The Remote Control Supplied with the MX121 A/V Control Center is capable of operating other components. For additional information go to www.mcintoshlabs.com.
21. The MX121 is compatible with the following Apple Mobile Devices with the latest version of the Apple OS Software installed:

iPod touch (4th generation)	iPhone 4S
iPod touch (3rd generation)	iPhone 4
iPod touch (2nd generation)	iPhone 3GS
iPod touch (1st generation)	iPhone 3G
iPod classic	iPhone
iPod nano (6th generation)	
iPod nano (5th generation)	
iPod nano (4th generation)	
iPod nano (3rd generation)	

Connector and Cable Information

XLR Connectors

Below is the Pin configuration for the XLR Balanced Output Connectors on the MX121. Refer to the diagrams for connections:

- PIN 1: Shield/Ground
- PIN 2: + Signal
- PIN 3: - Signal

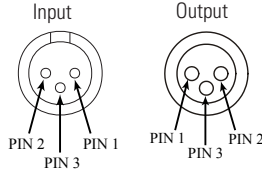

PWR CTRL (Power Control)/Trigger Connectors

The MX121 Power Control Out/ Trigger Output Jacks send an On/Off signal from 0 to +12 volts with a total current up to 50mA when connected to other Components. A 1/8 inch stereo mini phone plug is used for connection to the Power Control/ Trigger Outputs on the MX121.

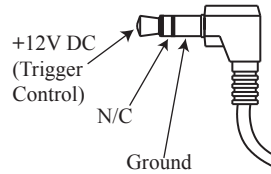

Data In and Output

The MX121 Data In receives Remote Control Signals from Source Components. The MX121 Data Out sends Remote Control Signals to McIntosh Source Components. A 1/8 inch mini phone plug is used for connection.

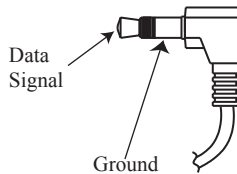

IR In Port Connector

The IR IN Port also uses a 1/8 inch mini phone plug and allows the connection of external IR Receivers to the MX121.

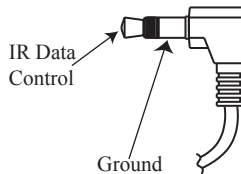

RS232 DB9 Connector Pin Layout

- 1. N/C
- 2. Data Out (TXD)
- 3. Data In (RXD)
- 4. N/C
- 5. Gnd.
- 6. N/C
- 7. N/C
- 8. N/C
- 9. N/C

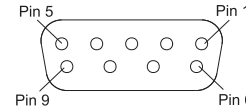

Ethernet RJ45 Socket

- 1. Transceive Data (+)
- 2. Transceive Data (-)
- 3. Receive Data (+)
- 4. N/C
- 5. N/C
- 6. Receive Data (-)
- 7. N/C
- 8. N/C

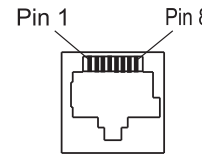

Ethernet Cable - Straight Thru Connections

Pin Number - Wire Color	→	Pin Number - Wire Color
1. Orange/White	→	1. Orange/White
2. Orange	→	2. Orange
3. Green/White	→	3. Green/White
4. Blue	→	4. Blue
5. Blue/White	→	5. Blue/White
6. Green	→	6. Green
7. Brown/White	→	7. Brown/White
8. Brown	→	8. Brown



Ethernet Cable - Crossover Connections

Pin Number - Wire Color	→	Pin Number - Wire Color
1. Orange/White	→	1. Green/White
2. Orange	→	2. Green
3. Green/White	→	3. Orange/White
4. Blue	→	4. Blue
5. Blue/White	→	5. Blue/White
6. Green	→	6. Orange
7. Brown/White	→	7. Brown/White
8. Brown	→	8. Brown



Introduction

The MX121 A/V Control Center sets the standard of excellence in a Home Theater System. The MX121 provides superior multichannel reproduction, Audyssey® Room correction, the latest in digital audio decoding and digital video processing circuitry.

Performance Features

• HDMI 1.4a with 3D Passthru Switching

There are six HDMI 1.4a Inputs. HDMI Output 1 includes the new Digital Audio Return Channel (ARC) signal from the TV¹, thus eliminating the need for an extra cable and simplifies operation. HDMI inputs are compatible with Deep Color, x.v.Color, Auto Lipsync and HDMI Component Control.

• Analog Video/Audio Switching with Scaling

Component Video Inputs and Composite Video Inputs (Analog Video Signals) are also converted to a Digital Video Signal with resolution up to 1080P at the HDMI Outputs.

• Direct Access

There are 9 Analog (one eight channel input) and 11 Digital Audio Inputs along with 9 Analog and 6 Digital Video Inputs.

• Balanced Inputs and Outputs

A pair of Balanced high level Inputs and an eight channel Balanced Output are provided, permitting long cable lengths without a loss in sound quality.

• Moving Magnet Phono Input

There is a Precision Phono Preamplifier for Moving Magnet Cartridges.

• Built-in Dolby True HD and DTS-HD Master Decoders

The MX121 also provides built-in decoding of the Dolby Pro Logic IIz, Dolby Pro Logic IIx, Dolby Digital EX, DTS Neo6 and DTS-ES Sound Tracks.

• Internet Streaming

The MX121 when connected to a network, offers Internet Radio, with music and photo streaming.

• On-Screen and Multifunction Fluorescent Displays

A comprehensive On-Screen Display capability makes it easy to perform setup and operational adjustments using the Remote Control. The front panel display indicates input selection, volume levels, and other operating functions.

• LED Channel Status Indicators

The MX121 includes twenty-five LEDs on the front panel to indicate what type of operating signals are being received, signal processing mode and the output format chosen.

• Audyssey DSX®

Audyssey DSX is a scalable system that adds new speakers to improve surround impression. Audyssey DSX first adds Wide channels for the biggest impact on envelopment and then creates Height channels to reproduce the next most important acoustical and perceptual cues. Surround Envelopment Processing is used to enhance the blend between the front and surround channels.

• Digitally Controlled Volume and Tone Controls

A Precision Tracking Volume Control adjusts all

twelve channels with tracking accuracy better than 0.5dB. The Bass and Treble circuits provide a wide range of tone shaping with no loss in traditional McIntosh sonic excellence.

• Triple Zones

The MX121 has the built-in ability to control a separate remote audio/video zone (Zone 2) with program selection independent of Main Zone, using a dedicated power amplifier and speakers. There is also a third Zone (Zone 3) providing a separate audio only source to another room.

• Fiber Optic Solid State Front Panel Illumination

The Illumination of the Glass Front Panel is accomplished by the combination of custom designed Fiber Optic Light Diffusers and extra long life Light Emitting Diodes (LEDs). This provides even Front Panel Illumination and is designed to ensure the pristine beauty of the MX121 will be retained for many years.

• Power Control, Triggers and Full Function Remote Control

The Power Control and Triggers provide convenient Turn-On/Off of components connected to the MX121. The Remote Control Push-buttons provide complete control of the MX121 operating functions.

• Machined Side Panels

The sides of the MX121 are machined from thick aluminum panels with a smooth black finish.

• Special Power Supply

The Power Supply has Multiple Regulators to ensure stable noise free operation even though the power line varies.

¹ For TVs with ARC compatibly



Dimensions

The following dimensions can assist in determining the best location for your MX121.

Front View of the MX121

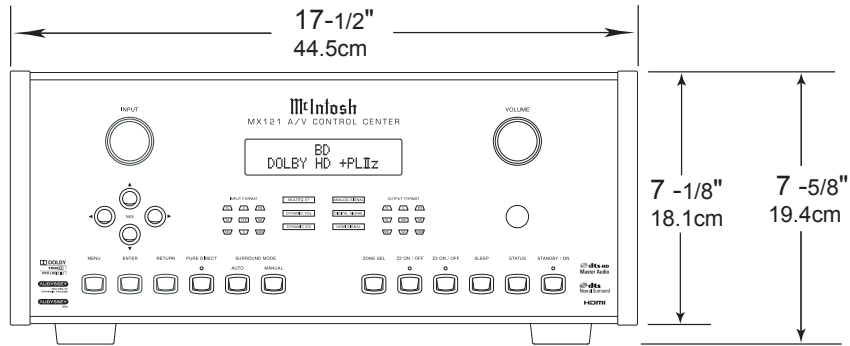

Rear View of the MX121

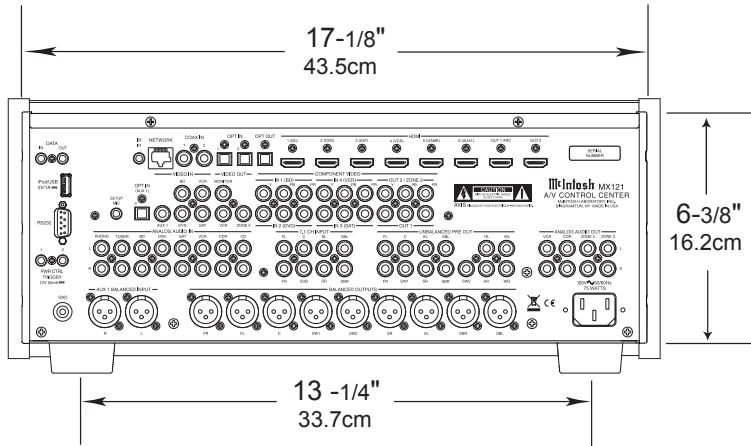

Side View of the MX121

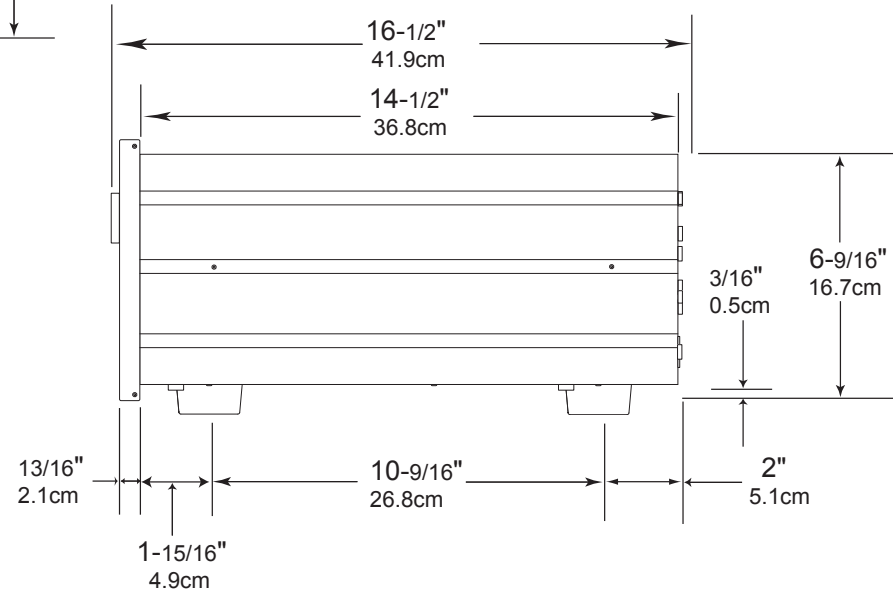

Installation

The MX121 can be placed upright on a table or shelf, standing on its four feet. It also can be custom installed in a piece of furniture or cabinet of your choice. The four feet may be removed from the bottom of the MX121 when it is custom installed as outlined below. The four feet together with the mounting screws should be retained for possible future use if the MX121 is removed from the custom installation and used free standing. The required panel cutout, ventilation cutout and unit dimensions are shown.

Always provide adequate ventilation for your MX121. Cool operation ensures the longest possible operating life for any electronic instrument. Do not install the MX121 directly above a heat generating component such as a high powered amplifier. If all the components are installed in a single cabinet, a quiet running ventilation fan can be a definite asset in maintaining all the system components at the coolest possible operating temperature.

When the MX121 is placed free-standing on a flat surface, allow at least 2 inches (5.08cm) above the top and 2 inches (5.08cm) on each side, so airflow is not obstructed. Allow 19-1/2 inches (49.53cm) depth behind the front panel. Allow 1-7/16 inch (3.66cm) in front of the mounting panel for knob clearance.

A custom cabinet installation should provide the minimum spacing dimensions for cool operation. Allow at least 2 inches (5.08cm) above the top, 2 inches (5.08cm) below the bottom and 2 inches (5.08cm) on each side, so airflow is not obstructed. The Custom Cabinet should be open backed and at least 12 inches (30.48cm) away from any surface such as a wall. Be sure to cut out a ventilation hole in the mounting shelf according to the dimensions in the drawing. Allow 1-7/16 inch (3.66cm) in front of the mounting panel for knob clearance.

**MX121 Front Panel
Custom Cabinet Cutout**

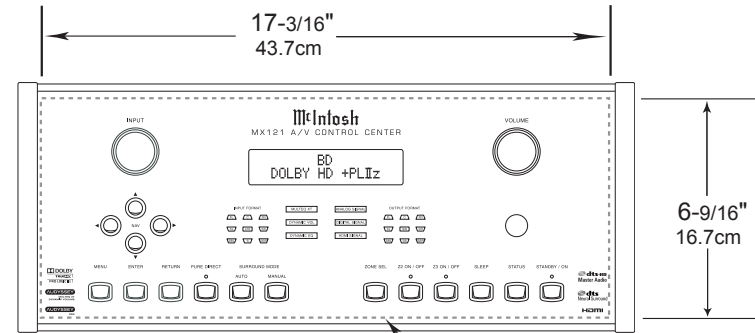

**MX121 Side View
in Custom Cabinet**

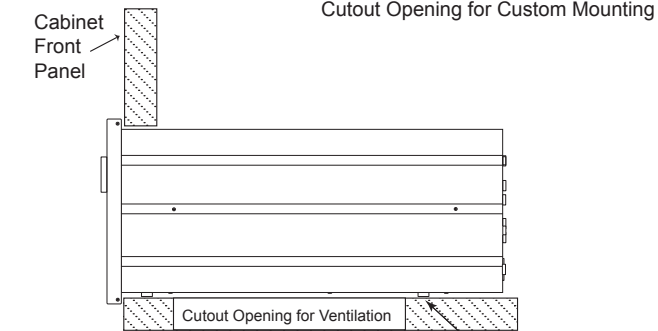

**MX121 Bottom View
in Custom Cabinet**

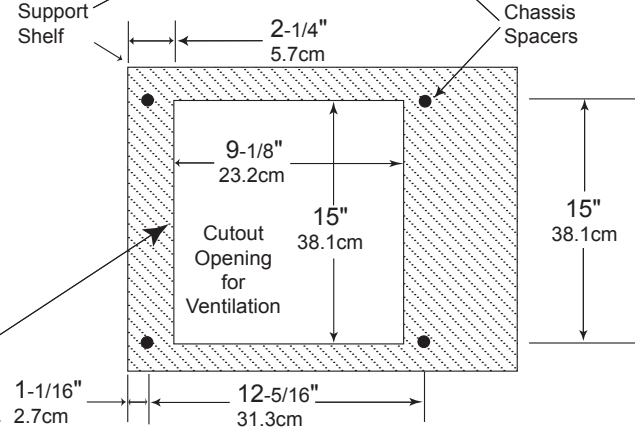

Note: Center the cutout horizontally on the unit. For purposes of clarity, the above illustration is not drawn to scale.



Rear Panel Connections

The identification of Rear Panel Connections for the MX121 A/V Control Center is located on a separate folded sheet contained in the Owner's Manual Packet. Refer to separate sheet "Mc1A" for the Rear Panel Connections.

MX121 A/V Control Center Rear Panel

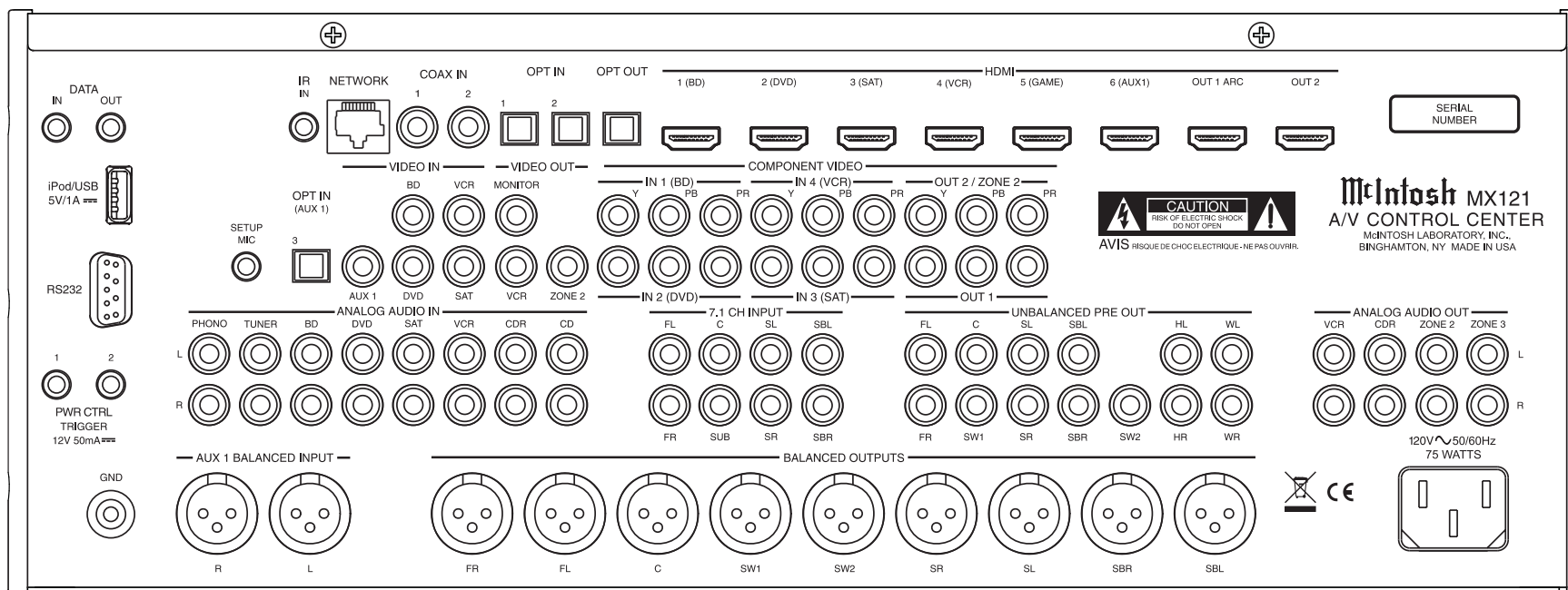

MX121 Main Zone Input Connections

The MX121 has the ability to automatically switch power On/Off to McIntosh Source Components via the Power Control/Trigger connections. The Data Port Connections allow for the remote operation of basic functions using the MX121 Remote Control. With an external sensor connected, remote control operation of the system is possible when the MX121 is located in a cabinet with the doors closed (Main Zone).

The Main Zone connection instructions below, together with the MX121 Input Connection Diagram located on the separate folded sheets “Mc2A”, is an example of a typical Home Theater System. Your system may vary from this, however the actual components would be connected in a similar manner. For additional information refer to “Connector and Cable Information” on page 6.

Note: The following source component and sensor connections made to the MX121 are using the default settings. Refer to page 24.

Power Control Connections:

1. Connect a Control Cable from the MX121 PWR CTRL TRIGGER 1 Jack to the Power Control Remote In on the Turntable.
2. Connect a Control Cable from the Turntable Power Control Remote Out jack to the AM/FM Tuner Power Control In Jack.
3. Connect a Control Cable from the AM/FM Tuner Power Control Out Jack to the Audio/Video Disc Player Power Control In Jack.
4. Connect any additional McIntosh Components in a similar manner, as outlined in steps 1 thru 3.
5. Connect a Control Cable from the Power Control Output Jack (from the last component a Power Control Input connection was made) onto the first Power Amplifier with a Power Control Input jack.

Data Control Connections:

6. Connect a Control Cable from the MX121 DATA OUT Jack to the AM/FM Tuner Data In Jack.

IR In Connections:

7. Optionally, connect the Control Cable from the Main Zone External Sensor (or external IR Connection Block) to the MX121 IR IN Jack.
Note: Refer to page 5 for information on compatible Sensors and page 6 for Cable/Connection information.

Analog Audio Connections:

8. Connect an Audio Cable from the MX121 ANALOG AUDIO IN TUNER Jacks to the Tuner unbalanced Analog Output Jacks.
9. Connect Balanced Cables from the MX121 AUX 1 BALANCED IN Jacks to the Audio/Video Disc Player Audio Outputs Balanced 2 Channel Jacks.
10. Connect an Audio Cable from the MX121 ANALOG AUDIO IN VCR Jacks to the VCR Analog Output Jacks.
11. Connect Audio Cables from the MX121 ANALOG AUDIO IN PHONO Jacks to the Turntable Out Jacks.

Digital Audio Connections:

12. Connect a Digital Coaxial Cable from the MX121 Digital COAX IN 2 Jack to the Satellite Receiver Digital Coaxial Output Jack.

Analog Video Connections:

13. Connect a Video Cable from the MX121 COMPONENT VIDEO IN 2 Jacks to the Satellite Receiver Component Video Output Jacks, making sure to match the “Y”, “PB” and “PR” connections at both ends of the cable.

HDMI Connections:

14. Connect a HDMI Cable from the MX121 HDMI IN 1 Connector to the Audio/Video Disc Player HDMI Out Connector.

Ground Connections:

15. Connect a Ground Cable from the MX121 GND Binding Post to the Turntable GND Binding Post.

Proceed to Main Zone Output Connections on the next page.



MX121 Main Zone Output Connections

The MX121 has the ability to automatically switch power On/Off to a McIntosh Power Amplifier via the Power Control/Trigger connection.

The connection instructions below, together with the MX121 Main Zone Output Connection Diagram located on the separate folded sheet “Mc2B”, is an example of a typical Home Theater System. Your system may vary from this, however the actual components would be connected in a similar manner. For additional information refer to “Connector and Cable Information” on page 6.

Note: The following component connections made to the MX121 are using the default settings. To make changes to the default settings proceed to Setup Mode starting on page 16.

Power Control Connections:

1. From the last component a Power Control Input connection was made to, connect the Control Cable to the Power Control In on Main Zone Power Amplifier One.
Note: If no source component(s) is connected for Power Control from the MX121, then connect a Control Cable from the PWR CTRL/TRIGGER Jack on the MX121 to the Power Control In on Main Zone Power Amplifier One.
2. Connect a Control Cable from Main Zone Power Amplifier One Power Control Out to Main Zone Power Amplifier Two Power Control In Jack.
3. Connect a Control Cable from Main Zone Power Amplifier Two Power Control Out to Main Zone Power Amplifier Three Power Control In Jack.
4. Connect a Control Cable from Main Zone Power Amplifier Three Power Control Out to the Powered Subwoofer Power Control In Jack.
5. Connect any additional McIntosh Components in a similar manner, as outlined in steps 1 thru 4.

Analog Audio Connections:

6. Connect Balanced Audio Cables from the MX121 BALANCED OUTPUTS (Main Zone) - FL (Front Left Channel), C (Front Center Channel) and FR (Front Right Channel) to Main Zone Power Amplifier One Inputs 1, 2 and 3 respectively.

Note: Unbalanced Audio Connections may be used in place of the Balanced Connections.

7. Connect Balanced Audio Cables from the MX121 BALANCED OUTPUTS (Main Zone) - SL (Surround Left Channel) and SR (Surround Right Channel) to Main Zone Power Amplifier Two, Inputs Left and Right respectively.
8. Connect Balanced Audio Cables from the MX121 BALANCED OUTPUTS (Main Zone) - SBL (Surround Left Back Channel) and SBR (Surround Right Back Channel) to Main Zone Power Amplifier Three, Inputs Left and Right respectively.
9. Connect a Balanced Audio Cable from the MX121 BALANCED OUTPUTS (Main Zone) - SW1 (Subwoofer) to the Powered Subwoofer MONO Input.

Note: Optionally Connect a second Subwoofer to the BALANCED OUTPUT (Main Zone) SW2 connection.

HDMI Connections:

10. Connect a HDMI Cable from the MX121 ZA HDMI OUT 1 ARC Connector to the Main Zone TV/Monitor HDMI Input Connector.

When Zone 2 (Audio/Video in another room) on the MX121 will be utilized, proceed to page 13 for information on making the needed additional connections. If Zone 2 will not be utilized at this time proceed to step 11 below.

AC Power Cords Connections:

11. Connect the MX121 and any remaining components' AC Power Cords to a live AC outlet.



MX121 Zone 2 Input Connections

In a typical MX121 two Zone Audio/Video System, Source Components can share the same Data Port Connections. The two Zones of the MX121 also share the same Analog Audio and Component Video Connections. The additional Analog Audio and Video Connections below are for Source Components connected to Main Zone via Digital Connections, as Zone 2 is Analog Audio/Video only.

The MX121 Zone 2 Input Connection Diagram (located on the separate folded sheet “**Mc3A** and **Mc3B**”) is an example of a typical Zone 2 Second Room System. Your system may vary from this, however the actual components would be connected in a similar manner. For additional information refer to “Connector and Cable Information” on page 6.

Note: The following connections made to the MX121 are using the default settings. To make changes to the default settings proceed to Setup Mode starting on page 16.

Sensor Connections:

1. Connect the Zone 2 Sensor to a external IR Connection Block and the output of the Connection Block to the MX121 IR IN Jack.

Note: If there is no external Sensor used for the Main Zone, a splitter is not needed. Connect the Zone 2 Sensor directly to the MX121 IR IN Jack.

Analog Audio Connections:

2. Connect an Audio Cable from the MX121 ANALOG INPUT IN TUNER Jacks to the AM/FM Tuner unbalanced Output Jacks.
3. Connect an Audio Cable from the MX121 ANALOG INPUT IN BD Jacks to the Audio/Video Disc Player Audio Outputs Unbalanced 2CH Jacks.
4. Connect an Audio Cable from the MX121 ANALOG INPUT IN SAT Jacks to the Satellite Analog Output Jacks.

Analog Video Connections:

5. Connect Component Video Cables from the MX121 COMPONENT VIDEO IN 1 Jacks to the Audio/Video Disc Player Component Video Output Jacks, making sure to match the “Y”, “PB” and “PR” connections at both ends.
6. Connect Component Video Cables from the MX121 COMPONENT VIDEO IN 3 Jacks to the Satellite Component Video Output Jacks, making sure to match the “Y”, “PB” and “PR” connections at both ends.

MX121 Zone 2 Output Connections

The MX121 has the ability to automatically switch power On/Off to McIntosh Power Amplifiers via the Power Control/Trigger connections.

The following connection instructions, together with the MX121 Zone 2 Output Connection Diagram located on the separate folded sheet “**Mc3B**”, is an example of a typical Zone 2 Second Room System. Your system may vary from this, however the actual components would be connected in a similar manner. For additional information refer to “Connector and Cable Information” on page 6.

Note: The following component connections made to the MX121 are using the default settings.

Power Control Connections:

1. Connect a Control Cable from the MX121 PWR CTRL/TRIGGER (Power Control) 2 Jack to the Power Control In on Zone 2 Power Amplifier.
2. Connect any additional McIntosh Components in a similar manner, as outlined in step 1.

Analog Audio Connections:

3. Connect Audio Cables from the MX121 ANALOG AUDIO OUT Zone 2 OUT Jacks - L (Left Channel) and R (Right Channel) to Zone 2 Power Amplifier Left and Right respectively.

Analog Video Connections:

4. Connect Component Video Cables from the MX121 COMPONENT VIDEO OUT 2/ZONE 2 Jacks to the Zone 2 TV/Monitor Video Input Jacks, making sure to match the “Y”, “PB” and “PR” connections at both ends.

AC Power Cords Connections:

5. Connect the MX121 and any remaining components’ AC Power Cords to a live AC outlet.



Front Panel Display, Controls, and Push-buttons

The identification of the MX121 A/V Control Center Front Panel Display, Controls, and Push-buttons is located on a separate folded sheet contained in the Owner's Manual Packet. Refer to separate sheet "Mc1B".

MX121 A/V Control Center Front Panel

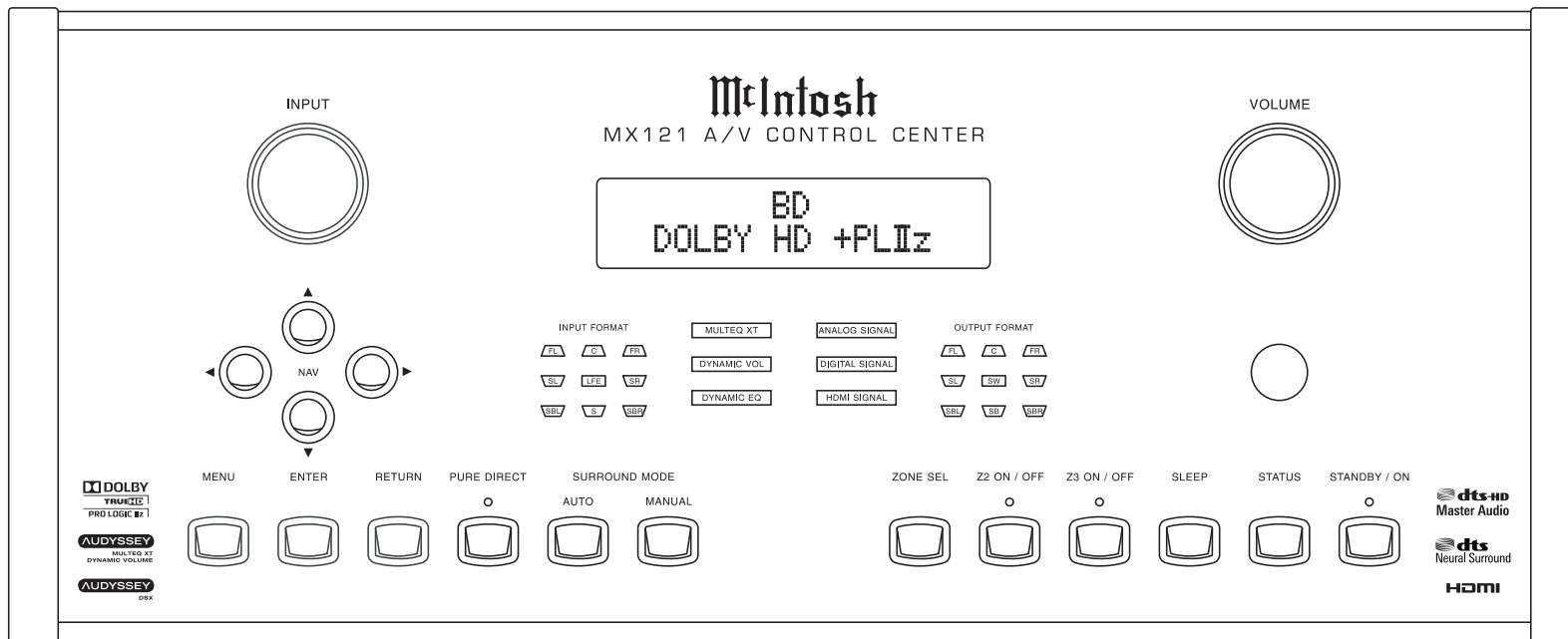

Remote Control Push-Buttons

The identification of Remote Control Push-Buttons for the MX121 A/V Control Center is located on a separate folded sheet contained in the Owner's Manual Packet.

Refer to separate sheet "Mc4A and Mc4B" for Push-buttons identification.

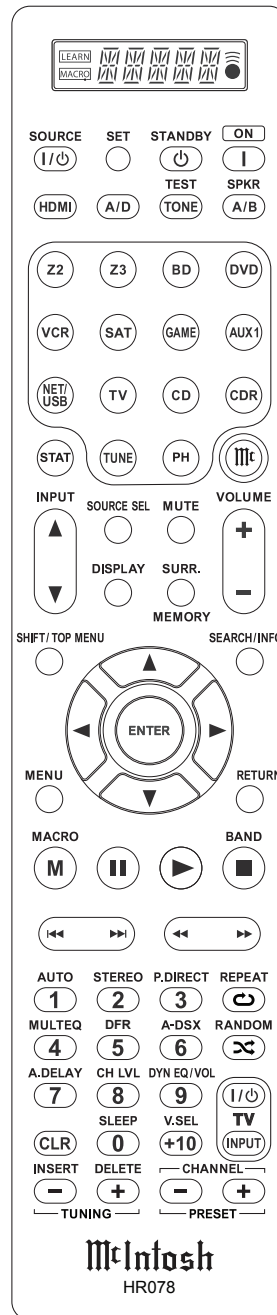

Introduction to the MX121 Setup Mode

Your McIntosh MX121 has been factory configured with default operating settings allowing for immediate use. Changes to the default settings are accomplished with the built-in Setup Feature using On Screen Menus.

To assist in navigating the various On Screen Menus please refer to the set of MX121 Menu separate folded sheets "MX121-Menu-1 thru Menu-7"; and to separate sheets "Mc4A thru Mc4B" for Push-button identifications. These separate sheets are contained in the Owner's Manual Packet.

Follow the sequence of SETUP Adjustments as they appear in this Owner's Manual, as they are interactive. Some of these adjustments and whether or not some choices even appear On-Screen are based on the components connected to the MX121, Source Input selected and previous settings made.

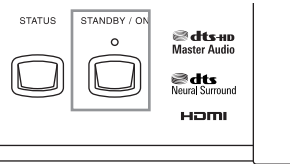

Figure 1

1. Press the STANDBY/ON Push-button on the Front Panel or press the ON (Power) Push-button on the Remote Control to switch On the MX121. Refer to figures 1 and 3. The Front Panel Information Display will first indicate "MX121 A/V Control Center" and then the last source selected "BD Stereo" and volume level setting of "M.VOL. ---.dB".
2. Press the Push-button, then press the MENU Push-button to enter the Setup Mode. The words "*MENU A/V Adjust ►" will appear on the Front Panel Information Display and the On-Screen "MENU" (Main Menu) will appear on the Monitor/TV Screen. Refer to figure 2.

Notes: 1. While Setup adjustments can be accomplished using the Front Panel Informa-

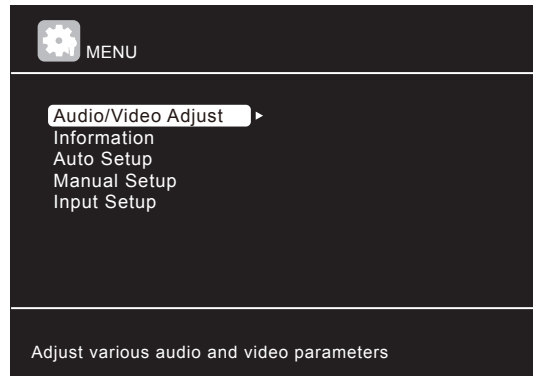

Figure 2

tion Display, the On-Screen Display on a Monitor/TV connected to the HDMI or Component Video output allows more information to be visible at the same time, making it easier to navigate through the choices.

2. When there is a HDMI Output Connection between the MX121 and a TV/Monitor, the On-Screen Overlays including Menus, will only appear on the HDMI Output.
3. Navigating thru and making changes to the Setup Menus is performed by using the HR078 Remote Control directional Up▲ or Down▼, Left◀ or Right▶, ENTER and the MENU Push-buttons. The Front Panel NAV ▲(up), ▼(down), ◀(left) or ▶(right) Push-buttons may also be used.
4. Access the desired Setup Menu or Device Management (Menu) by pressing the Up▲ or Down▼ left ◀ or right ▶ directional push-buttons. Pressing the ENTER Push-button will then activate the highlighted Menu Item.
5. Return to the Main Menu by pressing the RETURN Push-button on the Remote Control. To exit the SETUP Mode press the RETURN Push-button again.

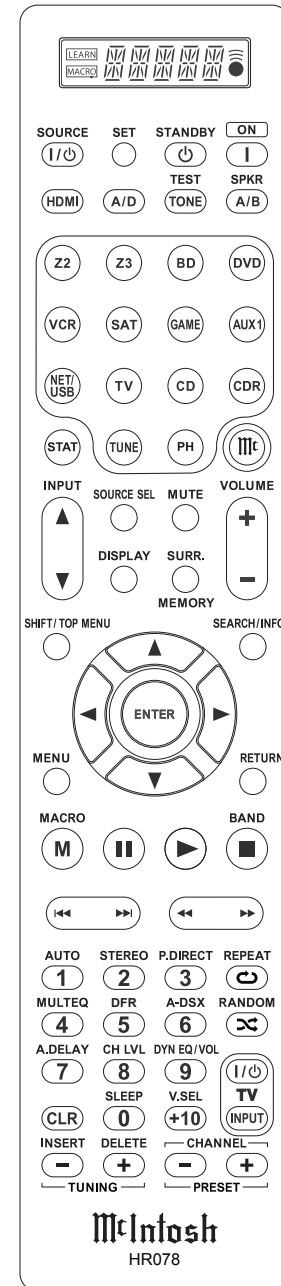

Figure 3

Audyssey® Auto Setup Information

The acoustic characteristics of the connected speakers and listening room are measured and the optimum settings are made automatically.

Assemble the supplied setup microphone and stand, then place it in the main listening position. Refer to the adjacent figure.

Keep the following things in mind during the Audyssey procedure:

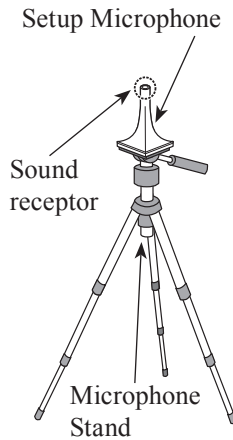

1. When placing the setup microphone, adjust the height of the sound receptor to the level of the listener's ear.
2. When performing Audyssey Auto Setup, MultEQ® XT/ Audyssey Dynamic EQ®/ Audyssey Dynamic Volume® functions become active.
3. Make the room as quiet as possible. Background noise can disrupt the room measurements. Close windows, silence cell phones, televisions, radios, air conditioners, fluorescent lights, home appliances, light dimmers, or other devices as measurements may be affected by these sounds.
4. Cell phones should be placed away from all audio electronics during the measurement process as Radio Frequency Interference (RFI) may cause measurement disruptions (even if the cell phone is not in use).
5. Do not unplug the setup microphone from the main unit until Audyssey Auto Setup is completed.
6. Do not stand between the speakers and setup microphone or allow obstacles in the path while the measurements are being made. This will cause inaccurate readings.
7. Loud test sounds may be played during Audyssey Auto setup. This is part of normal operation. If there is background noise in the room, these test signals will increase in volume.

8. Do not adjust Volume during the measurements as this will cancel the measurements.
9. Measurement cannot be performed when headphones are connected.
10. Do not hold the setup microphone in your hand during measurements.
11. Avoid placing the setup microphone close to a seat back or wall as sound reflections may give inaccurate results.

Measurements will be performed by placing the setup microphone successively at multiple positions throughout the entire listening area. For best results, we recommend you measure in six or more positions, as shown in the illustration (up to eight positions) about the main listening position (*M).

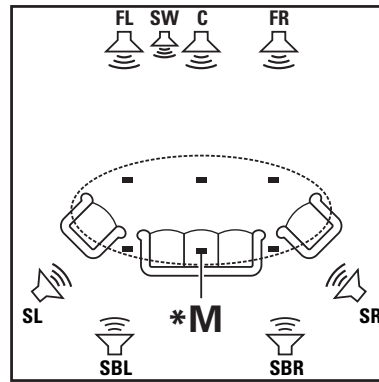

FL	Front speaker (L)	SL	Surround speaker (L)
FR	Front speaker (R)	SR	Surround speaker (R)
C	Center speaker	SBL	Surround back speaker (L)
SW	Subwoofer	SBR	Surround back speaker (R)

The main listening position is the position where listeners would normally sit or where one would normally sit alone within the listening environment. The ideal Loudspeaker Placement in a room for the best sonic effect is in the Side View Illustration:

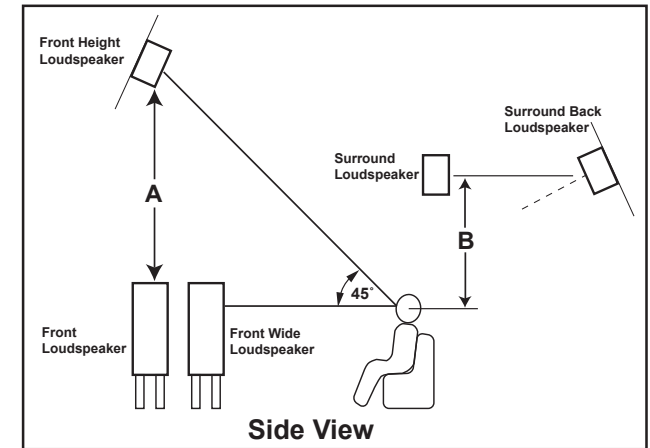

Both the Front Height and Surround Back Loudspeakers should be pointed slightly downward. Dolby recommends the **A** dimension be at least 3.3ft (1m). The **B** dimension should be between 2-3ft (60-90 cm). Before starting Audyssey Auto Setup, place the setup microphone in the main listening position. Audyssey MultEQ® XT uses the measurements from this position to calculate speaker distance, level, polarity, and the optimum crossover value.

When using a Powered Subwoofer(s) adjust the controls on the Subwoofer for neutral settings, as Audyssey will be making the adjustments of volume, crossover frequency, etc. Refer to the Subwoofer Owners Manual for additional information.

Proceed to "Audyssey Auto Setup Procedure" on the next page.



Audyssey® Auto Setup Procedure

With the MX121 connected to a TV/Monitor, the supplied microphone connected to the SETUP MIC Jack on the Rear Panel and placed in the "Main Listening location" perform the following steps along with the instructions appearing On-Screen:

1. Press the  Push-button, then press the MENU Push-button.
2. Using the Remote Control Directional Push-buttons select first "Auto Setup" followed by "Audyssey Auto Setup". Refer to the illustration below.

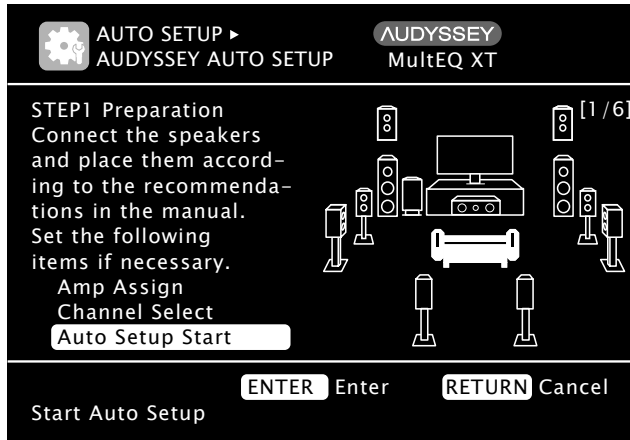

Note: If your system contains less than 7.1 channels please refer to "Amp Assign" on page 24 before proceeding.

3. Press the ENTER Push-button to start the Audyssey Auto Setup Process. A test tone will be sent to all channels, one at a time to identify the channels making up your system.

Notes: 1. Depending on the number of channels in your system the illustrations in this Owner's Manual might differ from the actual On-Screen Graphics.

2. During the setup process On-Screen error messages may appear, if they do refer to page 20 for assistance.

4. With the word "Measure" highlighted On-Screen press the ENTER Push-button to start the Measurement Process. A special audio test signal will be sent to all previously detected channels, one at a time. Refer to the illustration below.

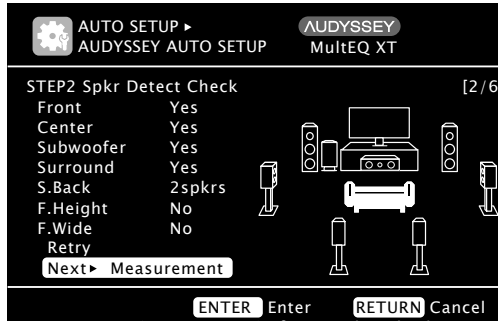

Audyssey System will take measurements from eight different locations in the room to achieve the best possible sonic results. The additional measurement locations are indicated by the small bars "—" in the room illustration, placed around the sitting area and the Main sitting position is indicated by an asterisk/letter m "*M". Refer to page 17.

5. Following the On-Screen instructions place the microphone in the 2nd listening position and then press the ENTER Push-Button to select highlight "Measurement". Refer to the illustration below.

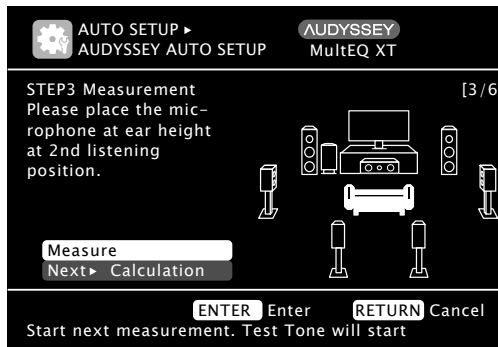

6. Continue following the On-Screen instructions repeat the measurement process as outlined in step 5 until all eight listening positions have been measured. The On-Screen message will now indicate the measurements are finished. Refer to the illustration below:

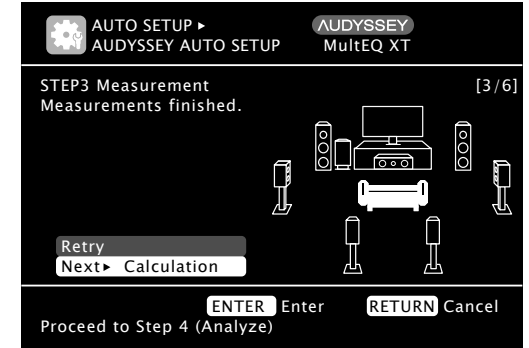

7. Using the Remote Control Directional Push-Button select "Next▶ Calculation" then press the ENTER Push-button. Refer to the Illustration below:

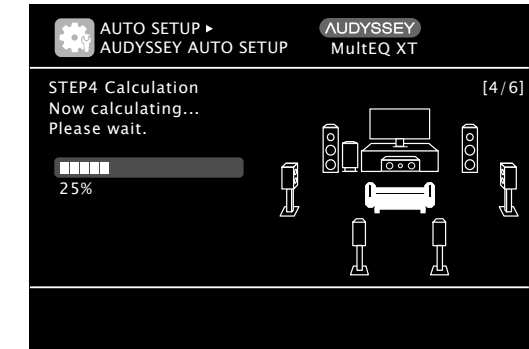

It will now take some time to process all the measurements made and arrive at the corrections necessary for each of the connected speakers to achieve the best possible sonic results.

Refer to the illustration below:

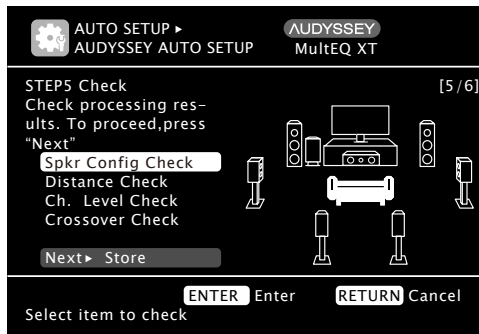

8. With "Next▶ Store" highlighted press the ENTER Push-button. Refer to the illustration below:

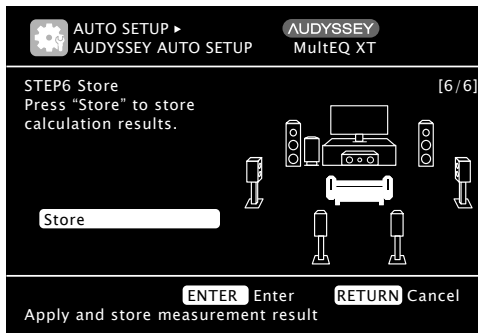

Note: If the measuring results are not to be saved, press the RETURN Push-button and a message "Cancel Auto Setup?" will be displayed. Press ◀, then select "Yes". All the measured Audyssey Auto Setup data will be erased.

9. With "Store" highlighted again, press the ENTER Push-button. Saving the results requires about 10 seconds. Refer to the illustration below:



10. Referring to the illustration below with "No" highlighted, press the ENTER Push-button. For more information about Audyssey Dynamic Volume® together with other Audyssey Operational Functions refer to page 37 in the "How to Operate" section of this Owner's Manual.

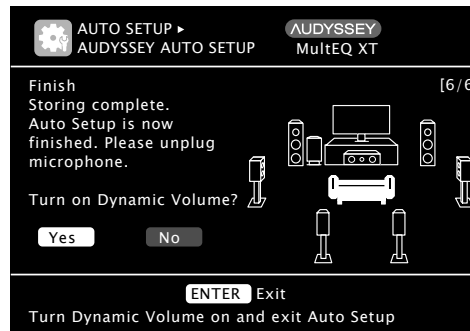

Note: Audyssey Auto Setup procedure will need to be performed again, when changes are made to the number of Loudspeakers, their replacement in the room or changes to the Subwoofer(s) Operational Controls.

Audyssey® Parameter Check

Once the Setup Process has been completed, the Parameter Check Function becomes available. From the On-Screen Main menu first select "Auto Setup" followed by "Parameter Check". Refer to the illustration below:

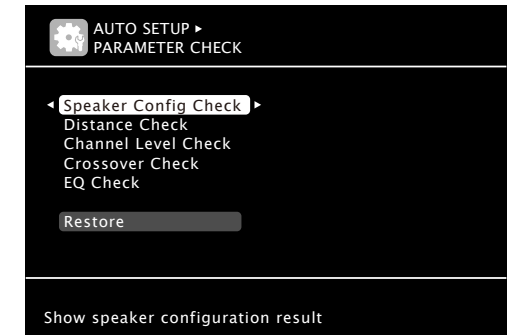

1. Using the Remote Control Directional Push-buttons, select the desired Parameter and follow the On-Screen Instructions.



Audyssey® Parameter Check

An error message is displayed if the Audyssey Auto Setup could not be completed due to speaker placement, the measurement environment, etc. If this happens, check the relevant items, make any necessary corrective measures, then perform Audyssey Auto Setup over again.

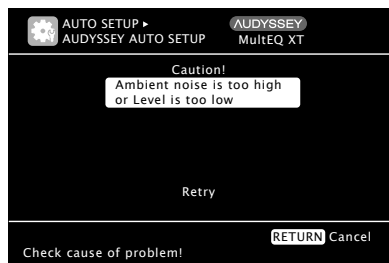
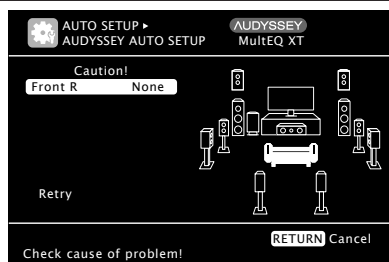
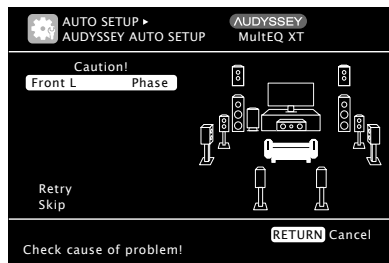
On-Screen Display	Error Details	Corrective Measures
	<p>The connected setup microphone is broken, or a device other than the supplied setup microphone is connected.</p> <p>Not all speakers could be detected. The front L speaker was not properly detected.</p>	<p>Connect the included setup microphone to the SETUP MIC jack of this unit.</p> <p>Check the speaker connections.</p>
	<p>There is too much noise in the room for accurate measurements to be made.</p> <p>Speaker or subwoofer sound is too low for accurate measurements to be made.</p>	<p>Either turn off any device generating noise or move it away.</p> <p>Perform again when the surroundings are quieter.</p> <p>Check the speaker installation and the direction in which the speakers are facing.</p> <p>Adjust the subwoofer's volume.</p>
	<p>The displayed speaker could not be detected.</p>	<p>Turn off the power before checking speaker connections.</p> <p>Check the connections of the displayed speaker.</p>
	<p>The displayed speaker is connected with the polarities reversed.</p>	<p>Check the polarities of the displayed speaker.</p> <p>For some speakers, this error message may be displayed even if the speaker is properly connected. If you are sure the connection is correct, press ▲ ▼ to select "Skip", then press ENTER.</p>

Network Settings and Functions

An example of a typical home network connected to the MX121 for access to the internet, your system might vary from this. Refer to figure below.

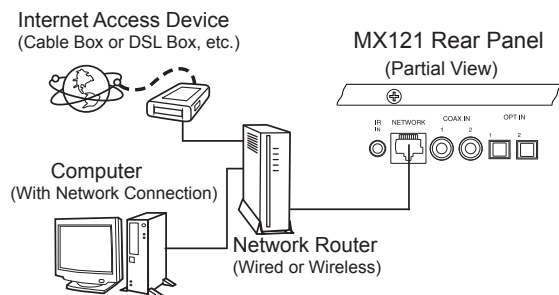

For additional information about PC Internet WEB Browser Programs, Computers, PC Network Connections and Settings, please refer to the documentation supplied with your computer and network hardware.

Broadband Internet and Network Connection Requirements

Modem:

Device that connects to the broadband circuit and conducts communications on the Internet. Routers with an integrated modem are also available.

Router:

With the MX121 we recommend using a router equipped with the following functions:

Built-in DHCP server - This function automatically assigns IP addresses on the LAN.

Built-in 100BASE-TX switch - When connecting multiple devices, we recommend a switching hub with a speed of 100 Mbps or greater.

Ethernet cable: (CAT-5 or greater recommended)

Use only shielded STP or ScTP LAN cable which is available at retailer. Some flat type Ethernet cables

are easily affected by noise. We recommend using a normal type cable.

- Notes:*
1. With the MX121, it is possible to use the DHCP and Auto IP functions to make the network settings automatically.
 2. When using the MX121 with the broadband router's DHCP function enabled, this unit automatically performs the IP address setting and other settings.

Network Automatic Functioning

When the MX121 is connected to a network consisting of DHCP compliant devices and the internet service provider is also DHCP compliant, no user manual settings in the MX121 need to be made for normal operations.

Network Manual Settings

When the MX121 is connected to a network with no DHCP Functions the following settings for the IP address, etc., will need to be made:

1. Connect the LAN cable then switch On the MX121.
2. Press the MENU Push-button, then select "Manual Setup", "Network Setup", "Network Connecting".
3. Using the Directional Push-buttons highlight the "Detail" Push-button then press the ENTER Push-button. Refer to figure 10.
4. With DHCP highlighted use the Directional Push-buttons to select OFF. Refer to figure 11.
5. Using the Directional Push-buttons to select "IP Address" followed by the IP Address entry field. Enter the number IP Address Number then press the ENTER Push-button.

IP Address: Set the IP address within the ranges shown below. The Network Audio

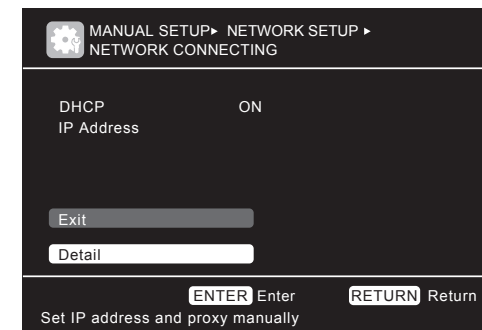

Figure 10

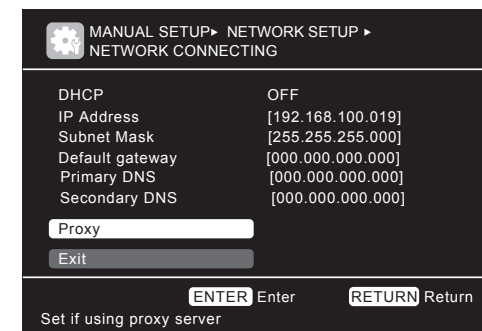

Figure 11

function cannot be used if other IP addresses are set.

CLASS A: 10.0.0.0 – 10.255.255.255

CLASS B: 172.16.0.0 – 172.31.255.255

CLASS C: 192.168.0.0 – 192.168.255.255

6. If the Subnet Mask, Default gateway, Primary DNS, and/or Secondary DNS settings need to be changed at this time enter them like the IP Address was entered.

Subnet Mask: When connecting an xDSL modem or terminal adapter directly to this unit, input the subnet mask indicated in the documentation supplied by your provider. Normally input 255.255.255.0.

Default Gateway: When connected to a gateway (router), input its IP address.



Network Settings and Functions, con't

Primary DNS and Secondary DNS: If there is only one DNS address indicated in the documentation supplied by your provider, input it at "Primary DNS". If there are two or more DNS addresses, input the first one at "Primary DNS".

Network Proxy Settings

When the MX121 is to be connected to the Internet via a proxy server perform the following:

1. Press the MENU Push-button, then select "Manual Setup", "Network Setup", "Network Connecting".
2. Using the Directional Push-buttons highlight the "Detail" Push-button then press the ENTER Push-button.
3. With DHCP highlighted use the Directional Push-buttons to select OFF. Then select "Proxy" and press the ENTER Push-button. Refer to figure 11.
4. Select Proxy "ON" by using the Directional Push-buttons. Refer to figure 12.
5. Using the Directional Push-buttons to select "Address" and then the "Name" and enter the information.
6. Enter the Proxy Server Port Number.
7. Select "EXIT" and then press the ENTER push-button.

Other Network Settings

Refer to figure 13 to make additional settings:

Network Standby:

Allows the MX121 to continue a Network Connection with a compatible controller when in the Standby Mode.

PC Language:

Allows the MX121 computer environment to be displayed in the desired language.

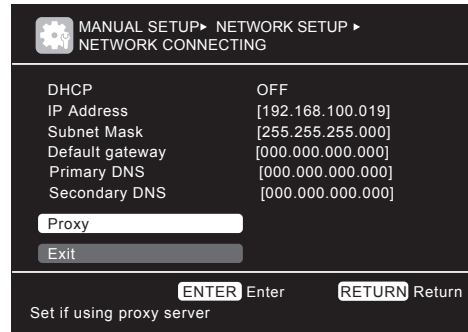

Figure 11

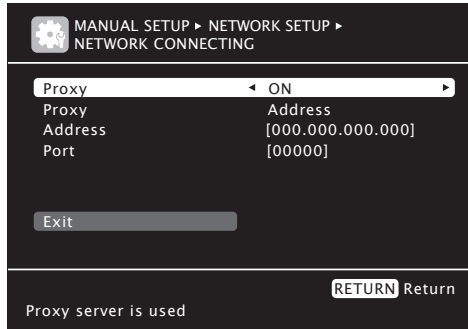

Figure 12

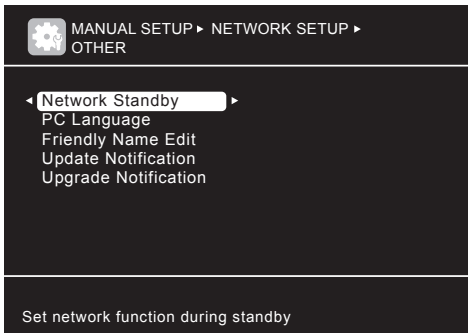

Figure 13

Friendly Name Edit:

Allows the renaming of "McIntosh MX121" as the name appears on the computer network.

Update Notification:

Allows the MX121 to display (default setting) "Firmware Update" on the Front Panel Information Display for about 20 seconds when first switched On.

Update Notification:

Allows the MX121 to display (default setting) "Add New Feature" on the Front Panel Information Display for about 20 seconds when first switched On.

Computer Control of the MX121 via the Network

From the Network Information Menu-Screen note the IP Address for the MX121. Enter the IP number on the URL Address Line in the Web Browser after "http://". Then press the Computer Keyboard "Enter" Key, figure 14 should appear several moments later.

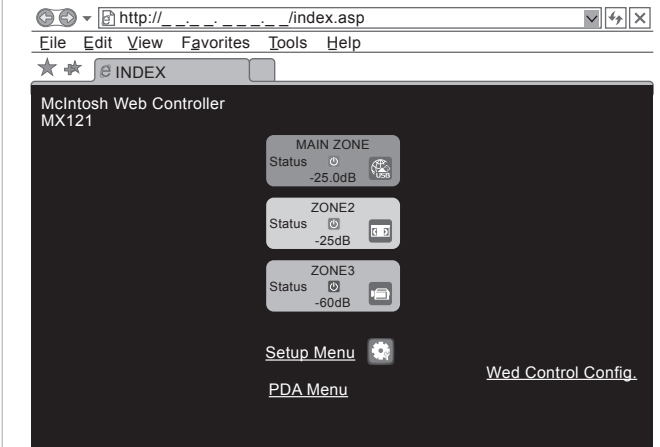

Figure 14

From this point forward, the MX121 Setup Functions will be carried out using the computer. Any Monitor/TV connected to a Video Output Connector the MX121 will only display the "McIntosh Logo".

Click on the "Setup menu" on the computer screen and the Main Setup On-Screen Menu will appear. Refer to figure 15.



Figure 15

Then click on "Source Select" and figure 16 will appear indicating the current settings for the DVD Input. Any input can be selected by clicking on the Source Box Field pull-down indicator.

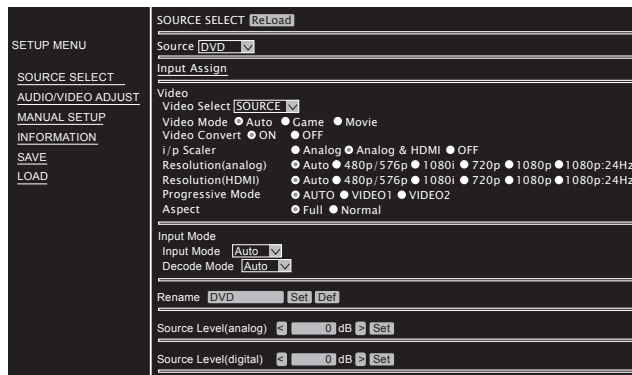

Figure 16

To end Computer Control of the MX121 switch to another URL Address or close down the Web Browser.

Trigger (Power Control) Settings

The MX121 has two Trigger/PWR CTRL (Power Control) Output Connections. They can be set to provide On (+12V) / Off (0V) Signal when the MX121 is On/Off (Main Zone, Zone 2 or Zone 3), when a specific Input Source is selected or when a TV/Monitor connected via HDMI to the MX121 switches On/Off. These signals are used to control Source Components, Power Amplifiers, or TV/Monitors connected to the HDMI Outputs, etc.

To change from the default setting of Triggers 1&2 On when any Zone (Main, Zone 2 or Zone 3) is switched On, perform the following:

1. Press the MENU Push-button, then select "Manual Setup", "Other Setup", "Trigger Out".
2. Use the Directional Push-buttons to select Trigger 1 or Trigger 2.
3. Then select either a given Zone, a given Input Source or HDMI Output 1 or 2 to activated the previously selected trigger.

Note: To return the Triggers to the default setting select the On-Screen "DEFAULT".

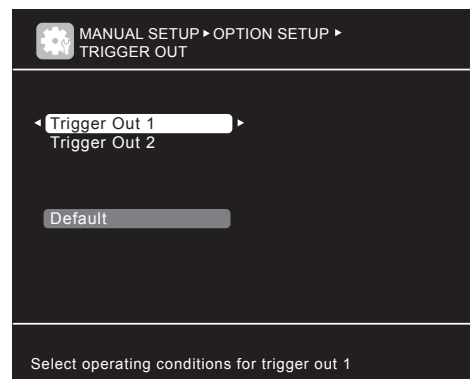

Figure 17

Option Settings

The MX121 has various options affecting the display of sound and visual information. Perform the following to make changes from the default settings:

1. Press the MENU Push-button, select "Manual Setup", then "Other Setup".
2. Use the directional push-buttons to affect changes.

VOLUME CONTROL:

- Relative --- Display indicates set in dBs from -80.5 to +18.
- Absolute --- Display indicates 0(min)-99.
- Volume Limit --- Off, -20dB, -10dB and 0dB.
- Power On Level --- Last (volume setting), 0 (muted) or -80dB to -18dB (1-99).
- Mute Level --- Full mute (no sound), -40dB or -20dB.
- Source Delete --- Remove from selections a given Input(s).

GUI:

- Screen Saver --- Blanks the On-Screen display approximately 3 minutes after user activity stops when viewing the Setup Menu or NET/USB/iPod source is selected. Other choice is Screen Saver disabled.
- Wall Paper --- Display the McIntosh Logo (picture) or blank (black background).

Text --- ON, indicates details of the selected Input and Surround Mode, etc. OFF, the information is not displayed.

Master Volume --- Displays the volume information at bottom or top of the screen, or not at all.

NET/USB --- Selects the duration of the displayed information (always, 30 seconds, 10 seconds or Off) when the NET/USB Input is first selected.

iPod --- Selects the duration of the displayed information (always, 30 seconds, 10 seconds or Off) when the iPod Input is first selected.

Component 2 Output --- Select the video output between the Main Zone or Zone 2.

Zone Rename --- Allow renaming of the Zones (up to ten characters long).



Default Input Connection Assignments

The MX121 has the most commonly used Inputs preassigned to HDMI, Digital Coaxial/Optical and Component Video (Analog) connections. There are also permanently assigned Analog Audio and Video connections. Please refer to the MX121 Menu separate folded sheet "**Menu-7**".

Default Input Connection Assignment			
Input Name	HDMI (Video/Audio)	Audio (Digital)	Video (Analog)
BD	HDMI-1	-	Component-1
DVD	HDMI-2	Coaxial-1	Component-2
VCR	HDMI-4	-	Component-4
SAT	HDMI-3	Coaxial-2	Component-3
GAME	HDMI-5	-	-
AUX1	HDMI-6	Optical-3	-
NET/USB	-	-	-
TV	-	Optical-1	-
CD	-	Optical-2	-
CDR	-	-	-
PHONO			
TUNER			

If there is a desire to reassign input connections proceed to "Input Connection Re-Assignment". Input names may also be changed, refer to Renaming Inputs on this page.

Input Connection Re-Assignment

The HDMI, Digital Coaxial/Optical and Component Video (Analog) Input Connections can be reassigned to match up with the components in your A/V System. To speed up the reassignment process make a list of the desired changes. A blank reassignment chart has been provide on the MX121 Menu separate folded sheet "**Menu-7**" for this purpose.

Notes: 1. The PHONO, TUNER and NET/USB Inputs by their nature do not require HDMI, Digital

Audio or Video Connections and therefore are not re-assignable.

- 2. A given connection type/number can only be assigned to one Input Name.*
- 3. First switch a given connection type/number to "NONE" before re-assigning it to a different Input Name.*

Make assignment changes by performing the following:

1. Press the MENU Push-button, then select "Input Setup" and then "Input Assign". Refer to figure 18.

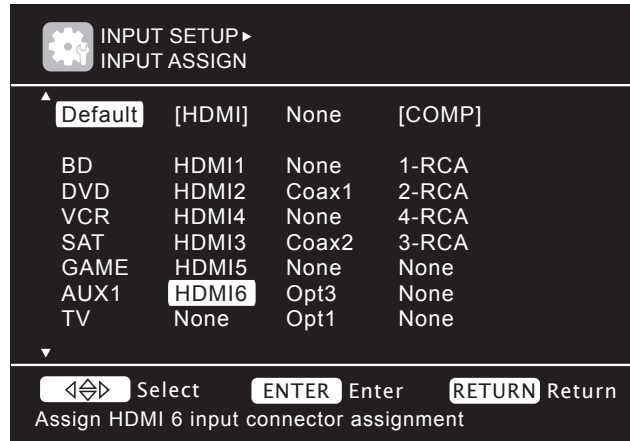

Figure 18

2. Use the Directional Push-buttons to select and the ENTER Push-button to change the current setting.
3. First select the Input to be changed.
4. Then select the HDMI, DIGITAL or COMP column.
5. Press the ENTER Push-button and then select from one of the available connections.
6. Press the ENTER Push-button to make the change.
7. In a similar manner make any additional changes.

Input Re-Naming

The MX121 default Input Names may be changed as desired. The new Input Name(s) will appear on the MX121 Front Panel Information Display and on the TV/Monitor.

To change the Input Name perform the following:

1. Press the MENU Push-button, then select "Input Setup" and then "Rename". Refer to the MX121 Menu separate folded sheet "**Menu-7**".
2. Use the Directional Push-buttons to select the Input.
3. Using the On-Screen Keyboard, enter the new name and press the ENTER Push-button.

The Front Panel Input Control, the INPUT ▲ ▼ on the Remote Control and the On-Screen Incon Control all allow selection of the Renamed Input.

Amplifier Assignment

The MX121 Amplifier Assignment allows the use of the Balanced Surround Back Channel Outputs to be used instead as Balanced Audio Outputs for Zone 2 or Zone 3. They can be used for Bi-Amp (spkr-c mode) of the Front Left and Right Channels. The Front L&R are Low Pass Outputs and the Surround Back Channels are Hi Pass Outputs for the Front Right and Left Channels.

To change the Amp Assign perform the following:

1. Press the MENU Push-button, then select "Manual Setup", "Speaker Setup" and then "Amp Assign".
2. Use the Directional Push-buttons to select "Zone2, Zone3 or SPKR-C".
3. Press the RETURN Push-button for the change to occur.
4. Switch the MX121 OFF and connect the Power Amplifier(s) to the MX121 to reflect the changes made.

Manual Speaker Setup

The MX121 with built-in Audyssey® automatically performs all the necessary speaker settings and corrects for the undesirable room acoustic. Refer to page 17. If for some reason you desire to manually enter all the speaker settings perform the following:

1. Press the MENU Push-button, then select "Manual Setup", "Speaker Setup" and then "Speaker Config". Refer to figure 19.

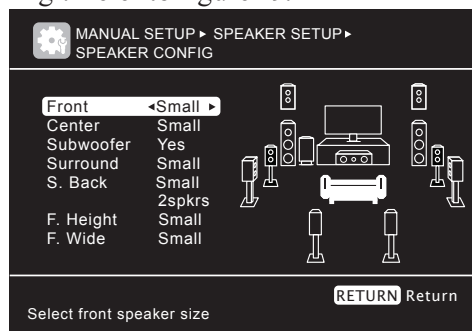

Figure 19

2. Following the instruction On-Screen, use the Directional Push-buttons to enter the speaker config information.

Note: Loudspeaker are consider "Large" when response goes down to at least 40Hz (-3dB). Loudspeakers not capable of response down to 40Hz (-3dB) are consider "Small".

3. Press the RETURN Push-button and then select "Bass Setting". Refer to figure 20.

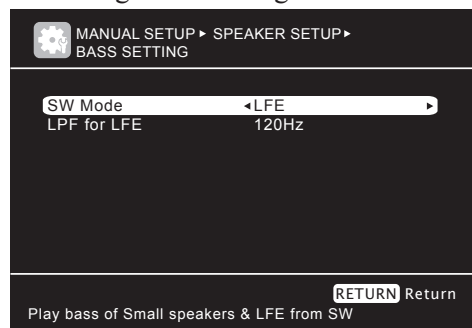

Figure 20

When the Front Speakers are Large, the Low Frequency Audio Signal is reproduced just by the Front Loudspeakers. The Subwoofer reproduces the LFE (Low Frequency Effect) Signal plus any Low Frequency Signals not reproduced by Small Speakers in the System. When the Bass Setting is set to "LFE + Main" the Low Frequencies reproduced by the Front Speakers will also be reproduced by the Subwoofer.

4. Set the SW Mode to the desired setting.
5. Select the "LPF for LFE" and set the LPF to the Highest Frequency Signal reproduced by the Front Large Speakers and is also sent to the Subwoofer.
6. Press the RETURN Push-button and then select "Distance" Setting. Refer to figure 21.

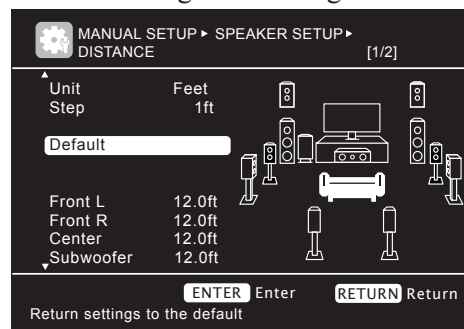

Figure 21

7. Measure and enter the distance from the main listening/viewing to each of the speakers.
 8. Press the RETURN Push-button and then select "Channel Level" Setting. Refer to figure 22.
 9. Using an accurate Sound Pressure Meter, measure the test signal coming from the speakers and make adjustments to achieve the same level for each of the speakers.
 10. Press the RETURN Push-button and then select "Crossover Frequency" Setting. Refer to figure 23.
- If there are speakers in the system considered small and they have the same Low Frequency Response

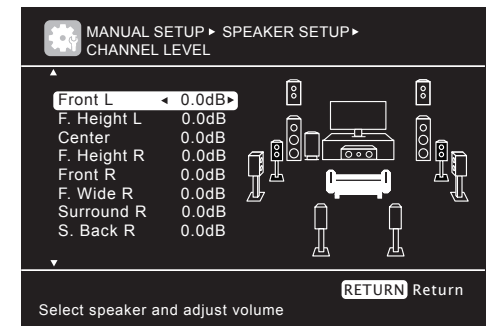

Figure 22

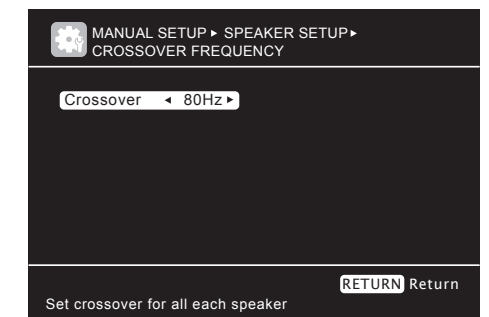

Figure 23

(-3dB point) then set the "Crossover __ _Hz" setting to that frequency. When there are speaker(s) with different Low Frequency Responses, select the "Crossover Advanced" setting. Then set the crossover frequency accordingly. Refer to figure 24.

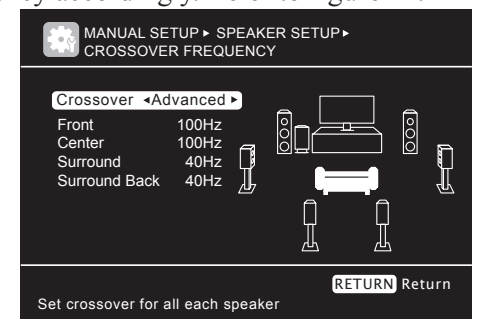

Figure 24

11. Press the MENU Push-button to exit Setup Mode.



HDMI Setup

The MX121 HDMI Setup allows the changing of various settings. To make changes to the default settings perform the following:

1. Press the MENU Push-button, then select "Manual Setup" and then "HDMI Setup". Refer to figure 25.

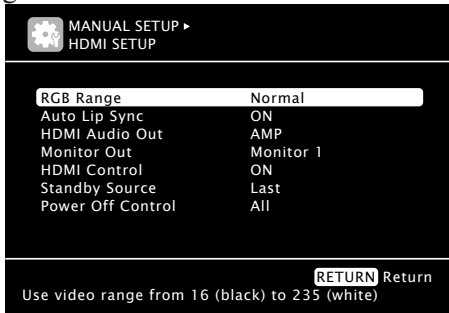

Figure 25

2. Use the Directional Push-buttons to select the desired HDMI Function and the Setting to be changed.

RGB Range --- The NORMAL Setting will produce a video range from 16 (black) to 235 (white). The ENHANCED Setting will produce a wider video range from 0 (black) to 255 (white).

Auto Lip Sync --- Makes automatic compensation for timing shift in audio and video output. The choices are ON and OFF.

HDMI Audio Out --- The AMP setting allows the audio to play through the MX121 System. The TV setting allows the Audio to play through the TV's Audio System.

Monitor Out --- Selects HDMI Output Monitor 1 or 2 as connected to the Main TV/Monitor.

HDMI Control --- Activates the ARC (Audio Return Channel) when connected to a compatible TV. The ARC allows the sound from the TV to be processed by the

MX121 without the need for an additional cable connection. Also when the HDMI Control is set to ON the MX121 will pass on through the HDMI Cable Control Functions. The default setting is OFF, the ON setting activates the control function when there is a HDMI cable connected between the MX121 HDMI OUT 1 ARC and the TV.

Note: The MX121 Input needs to be set to TV, in order for the ARC to function. Depending on the capability of the TV the Control Functions might include Power ON/OFF, adjust the MX121 volume, select MX121 Inputs, etc. Refer to the TV Owner's Manuals for details.

Standby Source --- The MX121 has a HDMI pass-thru mode when the HDMI Control is set to ON and the TV HDMI Control is also set ON. This allows the MX121 selected HDMI Input Source Component to pass its Video/Audio Signal directly to the TV when the MX121 is in the standby mode. The default setting of LAST is the HDMI Input Signal last selected on the MX121 before it goes into standby. The other option is to select a given HDMI Input as the pass-thru choice.

Power Control Off --- With Power Control Off active and HDMI Control set to ON, the MX121 will switch OFF when the TV is switched Off. The settings for Power Control Off include ALL (regardless of the MX121 input selected); VIDEO (when the MX121 Input Selected is BD, DVD, VCR, SAT, GAME,

AUX1 or TV); or OFF the MX121 will not switch Off automatically when the TV does.

Zone 2 and 3 Setup

The Zone Setup allows audio settings to be made for Zones 2 and 3 of the MX121. To make changes to the default settings perform the following:

1. Press the MENU Push-button, then select "Manual Setup" and then "Zone Setup". Refer to figure 26.

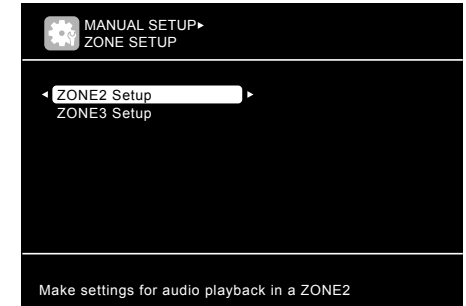

Figure 26

2. Use the Directional Push-buttons to select the desired setting to be changed.

Bass --- Adjust volume level of the Low Frequencies -10 dB to +10dB (default setting is 0dB)

Treble --- Adjust volume level of the High Frequencies -10 dB to +10dB (default setting is 0dB)

HPF --- The default setting is OFF, when set to ON the Low Frequency Response is reduced to prevent speakers with limited Low Frequency Response capability from being overdriven.

Level Lch --- With the CHANNEL set to Stereo, the Left Channel volume can be set from -12dB to +12dB (default setting is 0dB)

Level Rch --- With the CHANNEL set to Stereo, the Right Channel volume can be set from -12dB to +12dB (default setting is 0dB)

Channel --- Select the Mode STEREO default setting or MONO.

Volume Level --- The Zone 2 and Zone 3 outputs can be set to Variable Level Adjustment, default settings. They can also be set to a fixed Output Level at -40dB or 0dB.

Volume Limit --- Establishes the volume level when a Zone is switched ON. The choices include LAST, the volume setting at the time the Zone was switched Off; ___ (0) no sound; fixed volume level setting from -80dB to -18dB.

Mute Level --- The volume level when the MUTE Function is activated in Zone 2 or 3. The FULL setting totally mutes the all sound; -40dB reduces the current listening volume level by 40 decibels; -20dB reduces the current listening volume level by 20 decibels.

Picture Adjust Settings

The MX121 provides standard video adjustments for Sources having Video Signals associated with them, such as BD, DVD and SAT. Video settings are stored separately in memory for each of those inputs. Perform the following to adjust the picture:

1. Select the Audio/Video Input Source to be adjusted.
2. Press the MENU Push-button, then select "Audio/Video Adjust" and then "Picture Adjust" using the Directional Push-buttons. Refer to figure 27.
3. Select the Video Setting to be adjusted.
4. With the video from the selected source on the TV/Monitor Screen, make the desired adjustment.



Figure 27

5. Press the RETURN Push-button to select another video adjustment or press the MENU push-button to exit Setup Mode.

Contrast --- The default Setting is 0. The range of adjustment is from -6 to +6.

Brightness --- The default Setting is 0. The range of adjustment is from 0 to +12.

Chroma Level --- The default Setting is 0. The range of adjustment is from -6 to +6.

Hue --- The default Setting is 0. The range of adjustment is from -6 to +6.

DNR --- The default Setting is OFF. The DNR (Dynamic Noise Reduction) has settings of Low, Mid, High and affects the HDMI Inputs. Select the setting producing the best looking picture.

Enhancer --- The default Setting is 0. The range of adjustment is from 0 to +12. The Enhancer emphasizes contours in the picture on the HDMI Inputs. Select the setting producing the best looking picture.

IR Sensor Setting

The MX121 has a Front Panel IR Sensor along with provisions for also connecting an external sensor. With both sensors in the same room, possible interference can occur between the signals from both of them. To prevent possible operational problems it is necessary to disable the MX121 Front Panel Sensor. Perform the following steps to disable the sensor:

1. With the MX121 in STANDBY MODE press and hold down the ENTER and STATUS Push-buttons while pressing the STANDBY/ON Push-button. Refer to figure 28.
2. Release the three push-buttons.
3. The MX121 will go through its normal start up and then the Front Panel Information Display will briefly indicate "Remote Lock: ON".
4. To reactivate the Front Panel Sensor when the external sensor is disconnected, repeat steps 1 and 2.



Figure 28

Video Input Setup

Video Input Setup allows individual settings for each Input Source. These settings include the following:

- | | |
|------------------|---------------------|
| A. Video Select | E. Resolution |
| B. Video Mode | F. Progressive Mode |
| C. Video Convert | G. Aspect |
| D. i/p Scaler | |

Perform the following steps to make the settings:

1. Select the desired Source.
2. Press the MENU Push-button, then select "Input Setup", "Video" and then press the ENTER Push-button. Refer to figure 29.

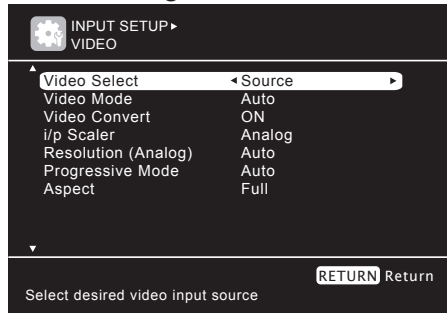

Figure 29

Video Select --- Select the Video Signal from another Input Source. Example listen to the TUNER Input while the TV/Monitor is displaying the video from the SAT Input. The video signal is from the Component Video or Composite Video connections only. Does include HDMI connections.

Video Mode --- Process Video Signal based HDMI Content (Auto Setting), Normal Video Processing (Movie Setting) or processing appropriate for displaying Game Content (Game Setting).

I/P Scaler --- Converts the resolution of the incoming Video Signal to the "RESOLUTION SETTING". The I/P setting include ANALOG for analog video signals, ANALOG &

HDMI for when the Input is assigned to both component video & HDMI. HDMI setting for digital video signal. OFF switches the I/P Scaling off.

Resolution --- AUTO, the default setting will select the resolution based on the native resolution of the TV/Monitor. The other available manual settings include from 480p through 1080p:24Hz. When a given MX121 Input has both HDMI and Component Video Connections assigned to it, the resolution of the HDMI connection can be set differently than the Component Video connection. Video Signals based on 50Hz can not be set to 1080p/24Hz.

Progressive Mode --- Sets the appropriate progressive video conversion to the selected video source signal. The setting choices include AUTO the progressive video conversion is set automatically, VIDEO1 is better suited for movie film based material or VIDEO2 is better suited for video 30 and 60 frame based material.

Aspect --- Sets the Aspect Ratio of the video output signal. The choices are FULL (the default setting) produces an aspect ratio of 16:9 or NORMAL produces a aspect ratio of 4:3.

Input Mode Setup

Input Mode Setup allows for establishing default audio settings for MX121 Inputs including selection of the audio connections types (HDMI, Coaxial/Optical Digital or Analog) and the type of Audio Signal Processing applied. Perform the following steps to make the settings:

1. Select the desired Source.
2. Press the MENU Push-button, then select "Input Setup", "Input Mode" and then press the ENTER Push-button. Refer to figure 30.

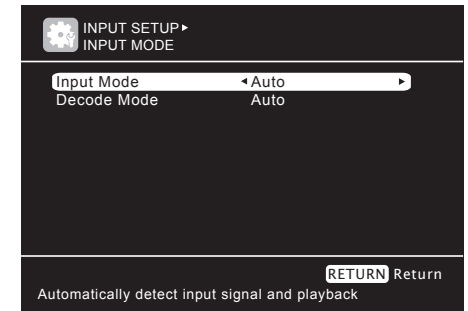

Figure 30

Input Mode --- Default setting is AUTO which selects from the available Audio Connections with signal present, starting with the highest resolution signal (HDMI) to the lowest resolution signal (Analog- 7.1CH-IN or Stereo RCA). The manual choices included HDMI, Digital, Analog or 7.1CH IN (Analog).

Decode Mode --- The default setting is AUTO which will automatically detect the digital signal format and play accordingly. The other two settings include PCM and DTS. When a digital signal matches either one of those two settings the signal will be decoded and sound will be heard.

Input Source Level

Input Source Level allows for setting volume levels for each of the Inputs. This helps to prevent an abrupt change in the volume when switching between different inputs. When a Source Input is assigned with both analog and digital input connections there are separate adjustments for each of them. Perform the following steps to make the settings:

1. Select the desired Source.
2. Press the MENU Push-button, then select "Input Setup", "Source Level" and then press the ENTER Push-button. Refer to figure 31.

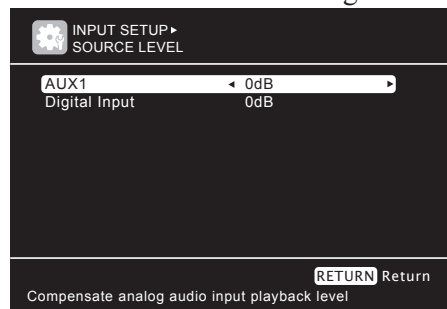

Figure 31

2. Use the Directional Push-buttons to select and make changes. The range of level adjustment is ± 12 dB.

Audio Setup

Audio Setup allows setting the 7.1 Channel Analog Input Subwoofer Level. There are also settings for not indicating all Audyssey® Settings on the MX121 Front Panel Information when the MULTEQ Push-button is pressed. Perform the following steps to make the settings:

1. Press the MENU Push-button, then select "Manual Setup", "Audio Setup" using the directional Push-buttons. Refer to figure 32.

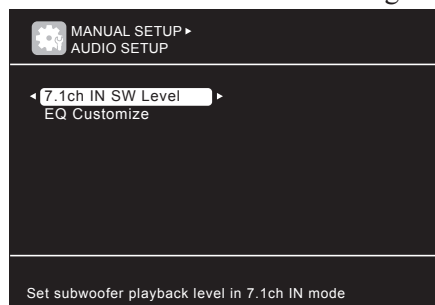

Figure 31

2. Use the Directional Push-buttons to select "7.1 ch in SW Level". The default setting for the MX121 is +10dB of which is the proper level for most DVD/Blu-ray players with 7.1 channel outputs. If after performing the players internal setup and the Subwoofer Output is either too low or too high in level to match the other channels, choose the MX121 other setting of +15dB, +5dB or 0dB.
3. To prevent certain Audyssey® Settings from being displayed and acted on, selecting one or more of the following:
 - Audyssey Byp. L/R --- Choices include USED (default setting) and NOT USED.
 - Audyssey Flat --- Choices include USED (default setting) and NOT USED.
 - Manual --- Choices include USED (default setting) and NOT USED.

Manual Equalization

The MX121 allows Corrective Equalization to be performed manually. Make sure the EQ Customize Settings under Audio Setup (previous column) are set to "used". Perform the following steps to make the settings:

1. Referring to the MX121 Front Panel Display, press the MULTEQ Push-button several times while watching the display until "MULTEQ XT MANUAL" appears.
2. Press the MENU Push-button, select "Audio/Video Adjust" then "Audio Adjust" using the directional Push-buttons. Refer to figure 32.

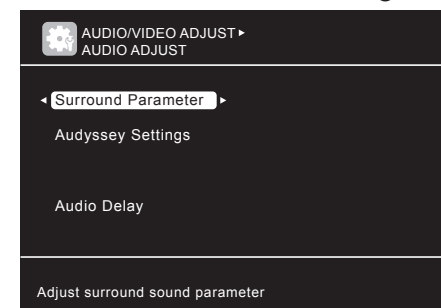

Figure 32

3. Select "Manual EQ" the press the ENTER Push-button. Refer to figure 33.

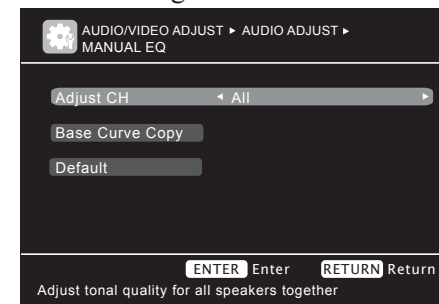

Figure 33

Manual Equalization, con't

- Using the directional push-buttons select from "All", "L/R" or "Each"; then press the ENTER Push-button. Refer to figure 34.

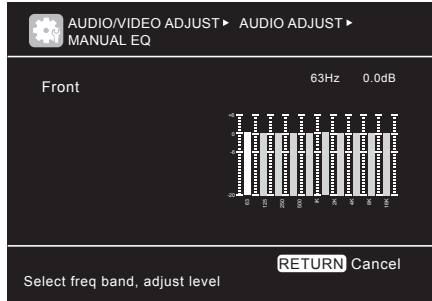

Figure 34

- Depending on the previous choice select a specific speaker and/or proceed to select a frequency band and make the desired increase or decrease in levels using the Directional Push-buttons.

The "Base Copy Curve" copies the Audyssey MultEQ flat response curve to provide a starting place for performing Manual Equalization. The "Default" setting returns all channels to 0dB.

Surround Parameter

The MX121 has additional Surround Processing Options depending upon the type of Input Signal (e.g. Dolby Digital, Dolby True HD, DTS, etc.). Perform the following steps to make changes to the default settings:

- Start Playback of the desired Source.
- Press the MENU Push-button, select "Audio/Video Adjust", "Audio Adjust" then "Surround Parameter" using the directional Push-buttons. Refer to figure 35.

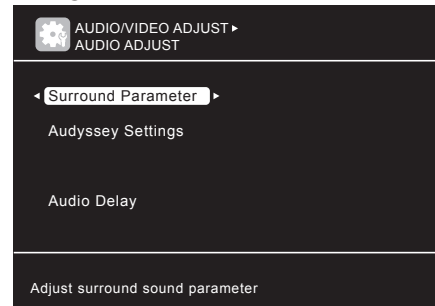

Figure 35

- Referring to figure 36 select the Surround Parameter to be changed.

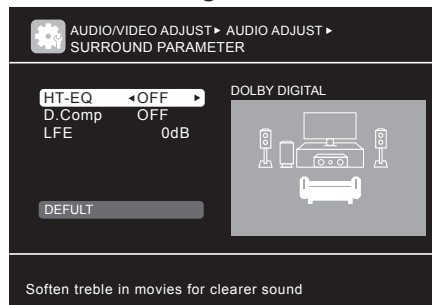

Figure 36

HT-EQ --- Softens the High Frequencies for better understanding.

DRC --- Reduces the dynamic range from loud to soft passages with Dolby True HD sound tracks.

The default setting is AUTO which will automatically adjust depending on the signal. LOW/MID/HIGH are manual settings.

OFF allows full dynamic range of the signal.

D.Comp --- Reduces the dynamic range from loud to soft passages. LOW/MID/HIGH are manual settings. OFF allows full dynamic range of the signal.

LFE --- Adjust the Low Frequency Effects level. Default setting is 0dB and other choice is -10dB.

C.Image --- Produces a wider Center Channel Image by sending some of the Center Channel information to the Front Left and Right Channels. Default setting is 0.3 and the range of adjustment is from 0.0 to 1.0.

Panorama --- Default setting is OFF, the ON setting sends some of the Front Left and Right information to the surround speakers.

Dimension --- Default setting is 3 with a range from 0 to 6. Shifts the sound image between Front and Rear speakers.

C. Width --- Default setting is 3 with a range from 0 to 7. Copies the Center Channel information and sends it the Front Left and Right speakers.

Height Gain --- When Front Height Speakers are in the system, there are three to choose from. The default setting is MID which sets a level to match the other channels. The other Settings are LOWER and HIGHER than the MID setting.

Default --- Returns all the Surround Parameter adjustment to their default settings.

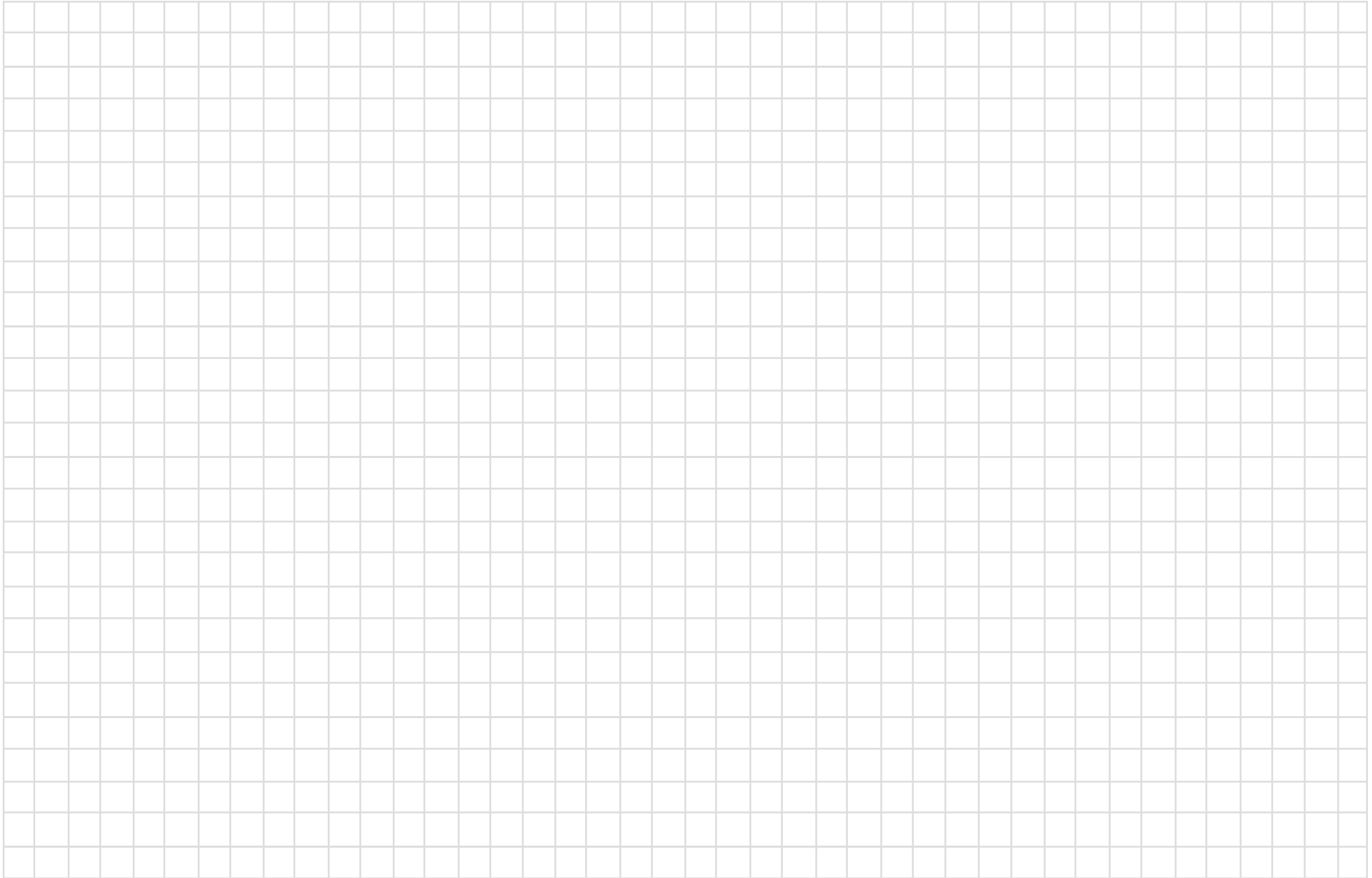



How to Operate the MX121

The McIntosh MX121 has been factory configured for default operating settings, allowing for immediate enjoyment of superb video and high fidelity audio without the need for further adjustments. If you wish to make changes to the factory default settings, refer to the SETUP Section of this Owner's Manual starting on page 16.

Notes: 1. It is advisable to perform "Audyssey Auto Setup" starting on page 17, to ensure the best audio performance.

2. In order for some of the Remote Control Push-Button Commands to be implemented by the MX121, such as activating the MENU SETUP Function, the LCD Display on the Remote Control needs to indicate "Mc". If the LCD Display does not indicate "Mc", press the  Push-button first before pressing the MENU Push-button.



Power On and Off

Press the STANDBY/ON Push-button on the Front Panel or press the ON Push-button on the Remote Control. The LED located above the STANDBY Push-button indicates when the MX121 is connected to AC Power. When the Initialization process is over, the display will indicate "BD" with a volume level of "M.VOL.---.dB", which is the factory default setting. The next time the MX121 is switched On, the last source selected at the desired volume will be active.

Note: If the MX121 A/V Control Center is not going to be used for an extended period of time, please remove the AC Power Cord from the AC Outlet.

Input Selection

The INPUT Control selects the desired source and is indicated on the top line of the Front Panel Information Display. Refer to figure 40. The selection of the

sources may also be accomplished by pressing the appropriate push-button twice on the Remote Control. Refer to figure 44. Using the MX121 INPUT Control, any one of the Inputs (CD, Tuner, DVD-Blu-ray, etc.) may be selected along with one Multichannel Analog Input. The Remote Control has twelve dedicated direct access push-buttons along with  INPUT  Push-buttons.

Note: To access the 7.1 Analog Multichannel Input use the A/D Push-button.

Volume Control

Adjust the VOLUME Control to select the desired listening level. The Volume Control adjusts all eight channels simultaneously, and level is indicated from ---.dB to (+)15.0dB 0 to 99% on the bottom line of the Front Panel Information Display. The Remote Control may also be used to adjust the listening level by using the VOLUME +/- Push-button.

During the time VOLUME Control is rotated or the Remote Control VOL +/- Push-button is depressed, an On-Screen Display Overlay will appear showing the Volume Level. When the MUTE Push-button is pressed, the Front Panel Information Display will indicate the word "Mute On" in place of the volume indication. Pressing the MUTE Push-button a second time, the listening volume level will be restored and the displays will again indicate the Volume Setting.

Front Panel Status

The three sets of Front Panel LEDs indicate the status of Input Format, Operating/Decoding Modes and the Output Format.

Note: If a Digital Input is selected and the Digital Source Component is not producing an output signal, none of the Front Panel Status LEDs will

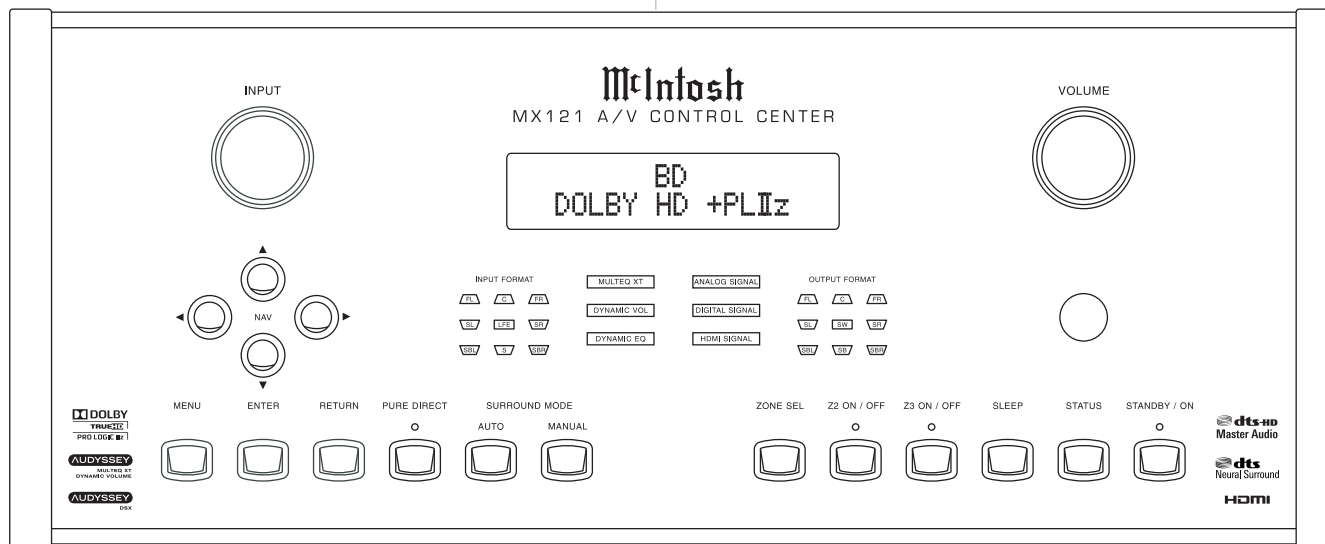

Figure 40

illuminate.

Input Format:

- A. If the input signal source is Eight Channel, the front panel INPUT FORMAT LEDs FL, C, FR, SR, SBR, SBL, SL and LFE will illuminate. Refer to figure 41.

- B. If a Digital Input Signal Source is 2 Channel Surround Encoded, the front panel INPUT FORMAT LEDs FL, FR and S will illuminate.

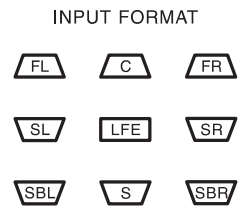

Figure 41

Note: The "S" indicator will only illuminate on some surround encoded program material.

- C. If the Analog Input Signal Source is Stereo, the INPUT FORMAT LEDs FL and FR will illuminate.
- D. If an Analog Input Signal Source is Mono, both channels will be receiving the mono signal and the INPUT FORMAT LEDs FL and FR will illuminate.

Operating Mode Displays:

- E. The ANALOG SIGNAL Display will illuminate when the audio input signal is analog. Refer to figure 42.
- F. The DIGITAL SIGNAL Display will illuminate when the audio input signal is Digital.
- G. The HDMI SIGNAL Display will illuminate when the audio input signal is Digital High Definition such as Dolby True HD or DTS Master HD.
- H. The MULTEQ XT Display will illuminate when Audyssey Room Correction Circuitry is Active.

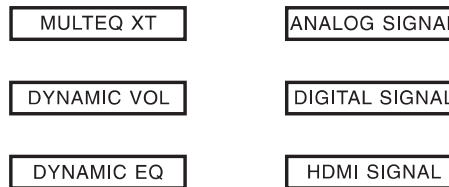

Figure 42

- I. The DYNAMIC VOL Display will illuminate when Audyssey Dynamic Volume Circuitry is Active.
- J. The DYNAMIC EQ Display will illuminate when Audyssey Dynamic Equalization Circuitry is Active.

Output Format:

- K. The OUTPUT FORMAT LEDs indicate the SURROUND MODE selected and the active audio channels. Refer to figure 43.

Note: The following example of the illuminated LED is based upon a 7.1 channel system. If your system is configured as something other than 7.1 (e.g. no Center Loudspeaker or a single Surround Back Loudspeaker) then the number of LEDs illuminated will be different.

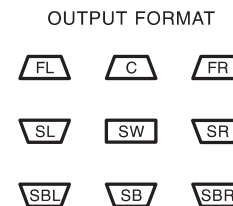

Figure 43

- L. NO PROCESSING mode for a two channel (Stereo) Input will cause the FL, FR and SUB LEDs to illuminate.

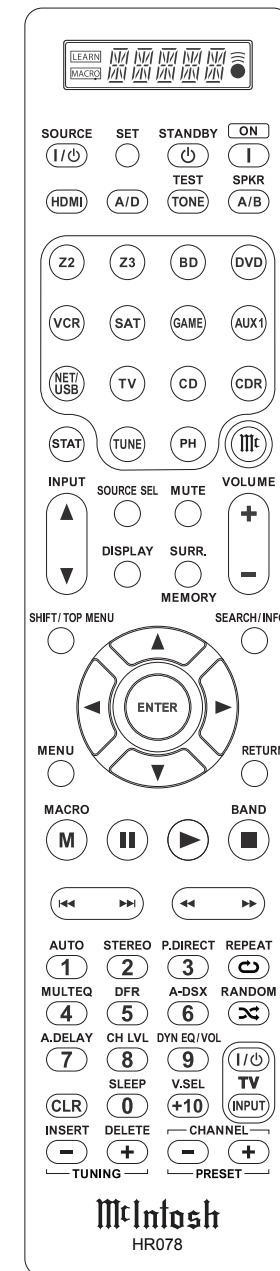

Figure 44



How to Operate the MX121, con't

- M. DPLIIx (MOVIE) or NEO: 6 (CINEMA) mode will cause the FL, C, FR, RS, SBR, SBL, SL and SUB to illuminate.
- N. DPLIIx (MUSIC) mode will cause the FL, C, FR, SR, SBR, SBL, SL and SUB to illuminate.
- O. DPLIIx (GAME) mode will cause the FL, C, FR, SR, SBR, SBL, SL and SUB to illuminate.

Menu

Pressing the MENU Push-button activates the MX121 SETUP Mode for making changes to the System settings.

Return

When the MX121 is in Setup Mode it is used for returning to a previous Menu Screen.

Enter

When the MX121 is in the Setup Mode it is used to select the highlighted option.

Navigate

The NAV ◀ (Left) and ▶ (Right) ▼ (Down) and ▲ (Up) Push-buttons move Left, Right, Down or Up through Menu Options.

Pure Direct

Bypasses the internal processing circuitry when not needed. An example could be when the analog audio output from a CD Player is connected to the MX121 and the CD player is playing a stereo CD disc. The settings include AUTO (default setting, the MX121 chooses the best signal processing), DIRECT (bypasses Back Surround and Front Height Channel processing) and PURE DIRECT (bypasses all digital processing).

Note: When switching between the three modes the sound is momentary muted.

Surround Mode

Press the AUTO Push-button to allow the MX121

processing circuitry to determine what is the best Surround Mode for the incoming audio signal. Repeated pressing the MANUAL Push-button allows the user to decide the desired Surround Processing Mode for the incoming audio signal.

Zone Select

With Zone 2 and/or Zone 3 On, the MX121 Front Panel Input Control, Volume Control and Information Display can be used temporarily to control the selected Zone.

Zone 2

Press the Z2 ON/OFF Push-button to switch Zone 2 On or Off.

Zone 3

Press the Z3 ON/OFF Push-button to switch Zone 3 On or Off.

Sleep

Repeated presses of the SLEEP Push-button will step through increments of 10 mins from OFF to 120 minutes at which time the MX121 will switch Off.

Status

Repeated presses of the STATUS Push-button will step through the type of incoming Audio Signal, the selected Input (along with type A/V Connection) and audio processing mode.

Main Zone Tone Adjustment

Please refer to the MX121 Menu separate folded sheet "Menu-2" for On-Screen Images. Using the Remote Control press the MENU Push-button and then using

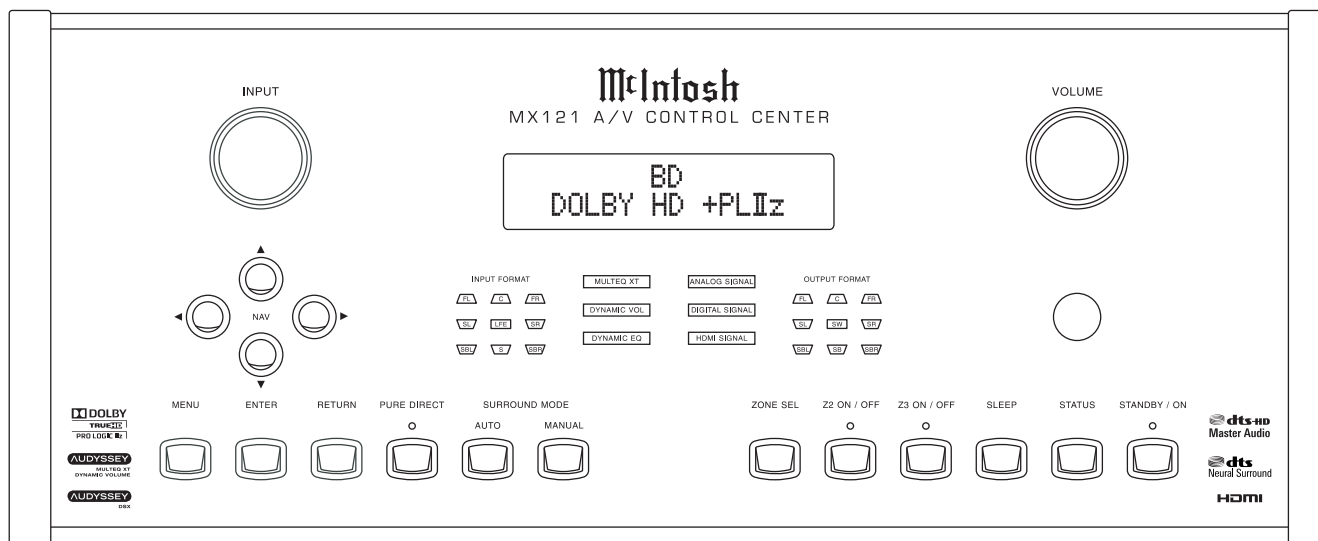

Figure 40

the Directional Push-buttons select "Audio/Video Adjust", "Audio Adjust" and then "Tone" followed by pressing the ENTER Push-button. First select "Tone Control" ON, then select "BASS" or "TREBLE". The range of tone adjustment is from -6dB to +6dB by using the Directional Push-buttons.

Audio Delay

The MX121 has built in Auto Lip Sync. Occasionally when viewing a specific Digital Audio/Video Program the Lip Sync might not be correct. To correct the problem press the A.DELAY Push-button on the Remote Control and then use the Directional Push-buttons to find a setting to bring into sync the image and sound.

DFR

When listening to audio program material that has been compressed such as the MP3 Sound Format, improvements in the sound quality can be made by using the built in DFR Circuitry. There are four DFR settings (OFF[default], LOW, MID and HIGH). Step through the settings by repeated pressing of the DFR (5) Push-button on the Remote Control. Refer to the Front Panel Information Display.

Note: The DFR Circuitry works with Analog and Digital PCM (44.1/48kHz) signals.

Analog/Digital Function

By repeated pressing of the A/D Push-button on the Remote Control, various Audio Input Connection Options appear on the MX121 Front Panel Information Display. Depending on the Input Source Name (and the connection assignment) the choices could include Auto, HDMI, Digital, Analog and/or 7.1CH IN. This allows listening to audio from other than the assigned Audio

Input Connection.

Note: For additional information refer to "Input Connection Assignment/re-assignment on page 24. When the A/D Function is set to "Auto" the MX121 will select the Audio Connection Type with signal present starting with HDMI (highest possible resolution) down through to Analog (lowest possible resolution).

On-Screen Source Select

Pressing the SOURCE SELECT Push-button on the Remote Control and the On-Screen Display will indicate the most recently selected Input Sources and for quick selection of another Input Source by use the Directional and Enter push-buttons. Refer to figure 45.

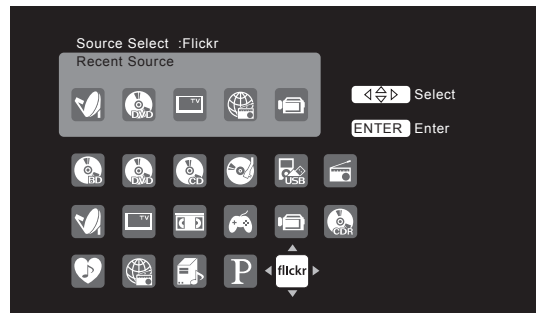

Figure 45

Speakers A and B Switching

When the Front Wide Channels as part of a 7.1 plus Home Theater System are not used, they can be used to drive an additional power amplifier (from the WL and WR unbalanced output connections) and a second pair of Front Left and Front Right Loudspeakers. Repeated presses of the SPKR A/B Push-button on the Remote Control steps through Speakers A, B or A+B.

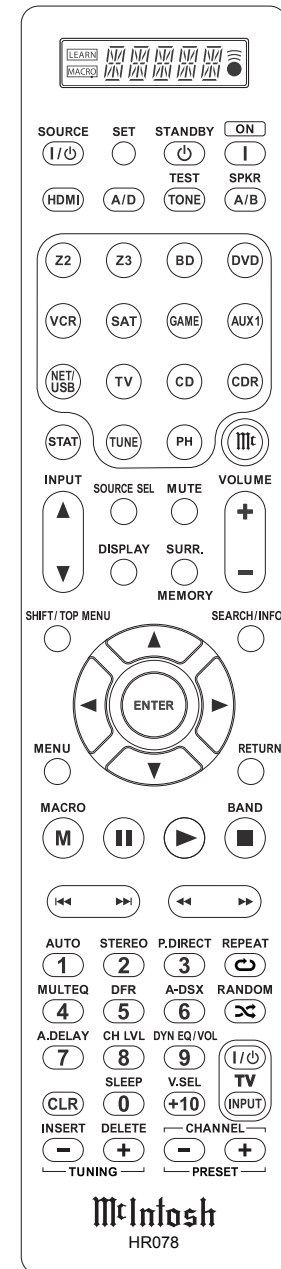

Figure 44

How to Operate the MX121, con't

Channel Level

Press the CH LVL Push-button on the Remote Channel and refer to figure 46. The Channel Level settings and the Fader adjustment allow for volume level changes to be made on the basis of playback of a specific movie/broadcast sound track.

Note: The settings are retained in memory until they are changed.

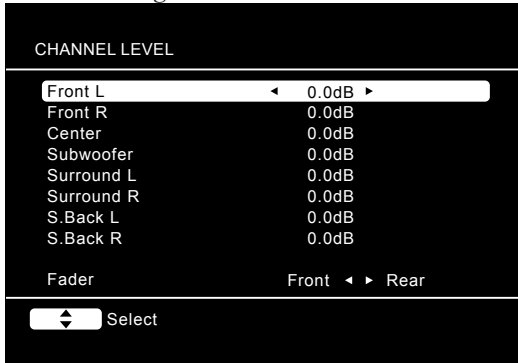

Figure 46

Remote Control Zone Operation

Using the Remote Control press the Z2 Push-button followed by the ON push-button to activate Zone 2. The Remote Control will indicate "ZONE2" on the LCD Display. Use the INPUT ▼ (Down) and ▲ (Up) Push-buttons to select the desired listening/viewing source. To switch OFF Zone 2 press the Z2 Push-button (unless the Remote Control LCD Display is indicating "ZONE2") followed by pressing the STANDBY Push-button.

Note: 1. The direct access push-buttons on the Remote Control are for selecting Source Inputs for the Main Zone only.

2. The operation of Zone 3 is similar to Zone 2 except Zone 3 is Audio only.

Playback of Music and Photo Files

When the MX121 is connected to a computer network including a computer, network storage device or a dedicated Network Server, the files stored on those devices become available for playback through the MX121 Audio/Video System. The network devices need to be setup for sharing of those files, refer to documentation supplied with the network devices on sharing files.

1. Press the NET/USB Push-button twice.
2. Using the directional push-buttons select from the On-Screen list of the devices located on the network containing the sharable music and/or photo files.
3. Locate the desired file to be played back and press the ENTER Push-button.



Audyssey® Adjustments

There are several additional functions Audyssey provides to further enhance the listening experience after it has first corrected for the acoustic imperfection caused by the listening room environment. Refer to page 17 to perform Audyssey Auto Setup for additional information.

To assist in navigating the various On Screen Menus please refer to the set of MX121 Menu separate folded sheets "MX121-Menu-1 thru Menu-7"; and to separate sheet "Mc4A/Mc4B" for Push-buttons identification. These separate sheets are contained in the Owner's Manual Packet.

Follow the sequence of SETUP Adjustments as they appear in this Owner's Manual, as they are interactive. Some of these adjustments and whether or not some choices even appear On-Screen are based on the components connected to the MX121 and previous settings made.

MultEQ® XT

MultEQ XT corrects both time and frequency response problems in the listening area based on Audyssey Auto Setup calibration. We recommend "Audyssey" MultEQ XT as the prerequisite function for Audyssey Dynamic EQ® and Audyssey Dynamic Volume®. Additional settings include Reference Level Offset and A-DSX Soundstage (when Front Height and/or Wide Loudspeakers are incorporated into the MX121 A/V System).

Viewing the Front Panel Information Display or On-Screen TV/Monitor Display, press MULTEQ Push-button repeatedly to select one equalizer mode from four available choices:

Audyssey: Optimize the frequency response of all speakers.

Audyssey Byp.L/R: Optimize frequency response of speakers except front L and R speakers.

Audyssey Flat: Optimize frequency response of all speakers to flat response.

Manual: Apply frequency response set with "Manual EQ".

OFF: Switches the "MultEQ XT" equalizer off.

Dynamic EQ and Dynamic Volume

Dynamic EQ solves the problem of deteriorating sound quality as volume is decreased by taking into account human perception and room acoustics and activates MultEQ XT.

Dynamic Volume solves the problem of large variations in volume level between TV, movies and other content (between quiet passages and loud passages, etc.) by automatically adjusting to the user's preferred volume setting.

Heavy: Most adjustment to softest and loudest sounds.

Medium: Medium adjustment to loudest and softest sound.

Light: Least adjustment to loudest and softest sounds.

OFF: Do not use "Dynamic Volume".

Viewing the Front Panel Information Display or On-Screen TV/Monitor Display, press the DYN EQ/VOL Push-button repeatedly to select the desired mode from five available choices:

1. Dynamic EQ: OFF
Dynamic Volume: OFF
2. Dynamic EQ: ON
Dynamic Volume: Heavy
3. Dynamic EQ: ON
Dynamic Volume: Medium

4. Dynamic EQ: ON
Dynamic Volume: Light
5. Dynamic EQ: ON
Dynamic Volume: OFF

Access to the settings of Reference Level Offset and/or A-DSX Soundstage is via the On-Screen Menus. Press the MENU Push-button, then select "Audio/Video Adjust", then "Audio Adjust", followed by "Audyssey Settings". Refer to the illustration below:

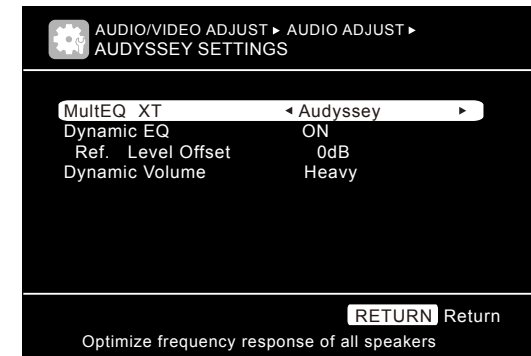

Reference Level Offset

Audyssey Dynamic EQ is referenced to the standard film mix level. It makes adjustments to maintain the reference response and surround envelopment when the volume is turned down from 0 dB. However, film reference level is not always used in music or other non-film content. Dynamic EQ Reference Level Offset provides three offsets from the film level reference (5 dB, 10 dB, and 15 dB) that can be selected when the mix level of the content is not within the standard.

- 0dB : This is the default setting and should be used when listening to movies (Film Ref).
- 5dB : Select this setting for content that has a very wide dynamic range, such as classical music.
- 10dB : Select this setting for jazz or other music that has a wider dynamic range. This setting should also be selected for TV content as that is usually



Audyssey® Adjustments, con't

mixed at 10 dB below film reference.

15dB : Select this setting for pop/rock music or other program material that is mixed at very high listening levels and has a compressed dynamic range.

Audyssey DSX® Setting

When the Front Height and/or Wide channels are present in the system, additional Audyssey DSX processing can be added to expand the sound stage. Viewing the Front Panel Information Display or On-Screen TV/Monitor Display, press A-DSX Push-button repeatedly to select the desired mode from three available choices:

1. ON-Height: Turn on A-DSX processing for height expansion.
2. ON-Wide: Turn on A-DSX processing for wide expansion.
3. OFF: Switch Off A-DSX processing.

Audyssey DSX Setting

When the Front Height and/or Wide channels are present in the system, additional Audyssey settings become available.

About Audyssey Dynamic Surround Expansion (A-DSX)

Audyssey DSX is a scalable surround expansion system that adds new channels to improve the surround impression. Based on research in human hearing Audyssey DSX adds a pair of Wide channels in the front because that information is critical in the rendering of a realistic soundstage.

Audyssey DSX then adds a pair of Height channels above the main front channels to reproduce the next most important acoustical and perceptual cues related to soundstage depth. In addition to creating these new channels, Audyssey DSX applies Surround Envelopment Processing to enhance the blend between the front and side/back surround channels. The result is a much more seamless and enveloping home theater experience.

iPod® Playback

Connect the iPod to the MX121 Rear Panel iPod/USB Connector using the cable supplied with the iPod. To playback music from the iPod through the MX121 perform the following steps:

1. Press the NET/USB Push-button twice on the Remote Control. Refer to figure 50.



Figure 50

2. Select "iPod" then press the ENTER Push-button. Refer to figure 51.

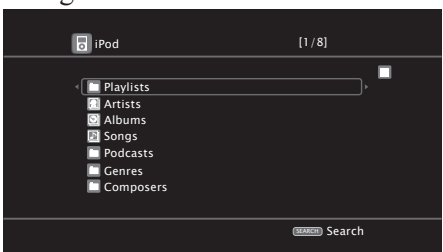

Figure 51

There are two modes for displaying the contents recorded on the iPod.

Remote Mode:

Display iPod information on the TV screen.

- A. The unit display shows single-byte alphanumeric characters and some symbols only. "." is displayed in place of incompatible characters.
- B. In "Remote mode", the iPod displays. Refer to figure 52.



Figure 52

Direct Mode:

Display iPod information on the iPod screen.

- C. "Direct iPod" is displayed on the display of this unit.

Display Mode		Remote Mode	Direct Mode
Playable files	Music File	Yes	Yes
	Video File	-	Only the Sound is Played
Active buttons	Remote Control Unit (This Unit)	Yes	Yes
	iPod®	-	Yes

3. Press and hold the SEARCH/INFO Push-button for at least 2 seconds to select the display mode.
4. Use the Directional Push-buttons to select the item, then press the ENTER Push-button to select the file to be played.
5. Press the ENTER Push-Button to start playback.
6. When in Remote mode, press STATUS during playback to check the title name, artist name, and album name.

AirPlay®

Before proceeding, download and install the latest version of iTunes (version 10 or later) on the computer connected to the same network as the MX121. Also update your iPhone, iPod touch or iPad to OS 4.2.1 or later, for streaming capabilities.

Use the Apple Remote App for iPhone, iPod touch and iPad to control iTunes from any room in your home. The app is available as a free download from the App Store.

1. Switch On the MX121.
2. Activate the SETUP Mode and set "Network Standby" to ON. Refer to page 16 and the set of MX121 Menu separate folded sheets "MX121-Menu-1 thru Menu-7".



Figure 55

3. Launch iTunes and click the AirPlay icon displayed in the lower right of the window and then select the MX121 from the list. Refer to figure 55.
4. Choose a song and click play in iTunes. The music will stream to the MX121.

Streaming music from iTunes

To steam music from iTunes on your computer to the MX121 perform the following:

5. Click the AirPlay Icon in iTunes and then select "Multiple Speakers from the list. Refer to figure 55.

6. From the list appearing in iTunes select McIntosh:[MX121]. Refer to figure 56.

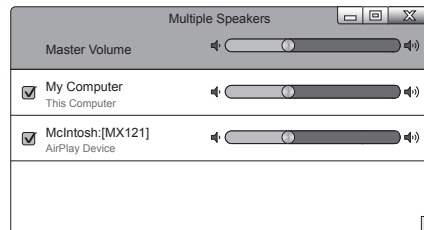

Figure 56

Streaming music from iPhone, iPod touch or iPad

To stream music stored on your iPhone, iPod touch or iPad directly to the MX121 perform the following:

7. Tap the AirPlay Icon on the iPhone, iPod touch or iPad. Refer to figure 57.

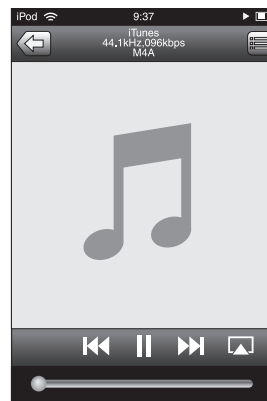

Figure 57

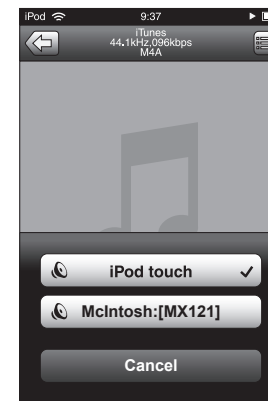

Figure 58

8. From the list appearing on the iPhone, iPod touch or iPad select McIntosh:[MX121]. Refer to figure 58.

Remote Operation

To use the McIntosh MX121 Remote Control to play and pause iTunes, as well as skip to next and previous tracks, perform the following:

9. With iTunes running, select "Edit", then "Preferences". Refer to figure 59.

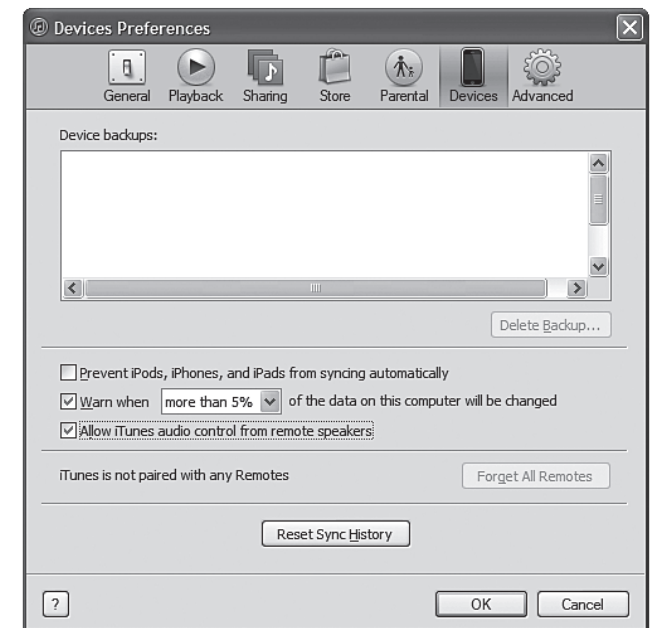

Figure 59

10. Select the "Devices" icon, then check "Allow iTunes audio control from remote speakers".

- Notes:*
1. Source input will be switched to "NET/USB" when AirPlay playback is started.
 2. Stop AirPlay playback by pressing the ◀ button or choosing another Input Source.
 3. To see song and artist names together, press the STATUS Push-button.
 4. The screen may differ depending on the OS and software versions.
 5. For information about how to use iTunes, click on Help.



USB Drive Playback

Connect the USB Memory Device directly to the MX121 Rear Panel iPod/USB Connector. To playback music and still images from the USB Memory Device through the MX121 perform the following steps:

1. Press the NET/USB Push-button twice on the Remote Control.
2. Select "USB" then press the ENTER Push-button. Refer to figure 53.

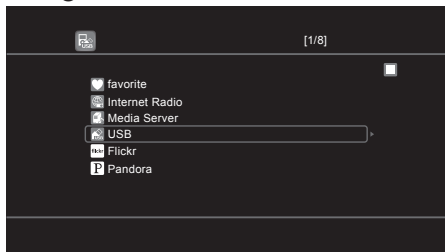

Figure 53

3. Using the Direction Push-buttons select the desired music track or picture. Refer to figure 54.

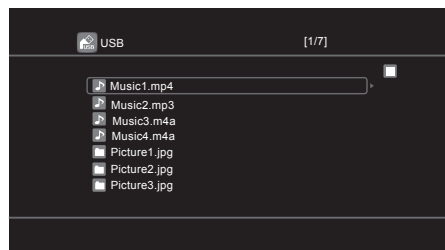

Figure 54

4. Then press the ENTER Push-button to start playback of music or still image.

Note: The default setting for the duration of still images displayed On-Screen is 30 seconds. The setting may be changed. Refer to the Setup section of this manual along with separate folded sheet "MX121-Menu-6".

When using the USB Memory Device the following are important things to keep in mind:

1. If the USB memory device is divided into multiple partitions, only the top partition can be selected.
2. The MX121 is compatible with MP3 files conforming to "MPEG-1 Audio Layer-3" standards.
3. Only USB memory devices conforming to mass storage class and MTP (Media Transfer Protocol) standards can be played on the MX121.
4. The MX121 is compatible with USB memory devices in "FAT16" or "FAT32" format.
5. The MX121 plays back image (JPEG) files in the orientation in which they are stored in the folder.
6. It is not possible to connect and use a computer via the USB port of this unit using a USB cable.

Compatible Formats	USB Memory Devices (A thru C)
WMA (Windows Media Audio)	Yes (D)
MP3 (MPEG-1 Audio Layer-3)	Yes
WAV	Yes
MPEG-4 AAC	Yes (E)
FLAC (Free Lossless Audio Codec)	Yes
JPEG	Yes

- A. This unit is compatible with MP3 ID3-Tag (Ver. 2) standard.
- B. This unit can show the artwork that was embedded by using MP3 ID3-Tag Ver. 2.3 or 2.4.
- C. This unit is compatible with WMA META tags. WAV format Quantization bit rate: 16 bits. FLAC format Quantization bit rate: 16/24 bits.
- D. Copyright-protected files can be played on certain portable players compatible with MTP.
- E. Only files that are not protected by copyright can be played on this unit. Content downloaded from pay sites on the Internet are copyright protected. Also, files encoded in WMA format when ripped from a CD, etc. on a

computer may be copyright protected, depending on the computer's settings.

Compatible Formats	Sampling Frequency	Bit Rate	Extension
WMA (Windows Media Audio)	32/44.1/48kHz	48-192 kbps	.wma
MP3 (MPEG-1 Audio Layer-3)	32/44.1/48kHz	32-320 kbps	.mp3
WAV	32/44.1/48kHz	-	.wav
MPEG-4 AAC	32/44.1/48kHz	16-320 kbps	.aac/ .m4a/ .mp4
FLAC (Free Lossless Audio Codec)	32/44.1/48k/ 88.2/96kHz	-	.flac



Accessing the Internet

Your McIntosh MX121 has been factory pre-configured for accessing several Internet Media Streaming Sites. The pre-configured sites vary depending upon the location where the MX121 will be used. McIntosh's own special site (via vTuner) is available for all locations.

The Internet Sites can provide Streaming Music (also known as Internet Radio) and Streaming Photographs available thru the MX121. For more information about this refer to sources such as http://en.wikipedia.org/wiki/Internet_radio via your computer or mobile device and a WEB Browser.

An example of a typical home network connected to the MX121 for access to the internet, your system might vary from this. Refer to figure 70.

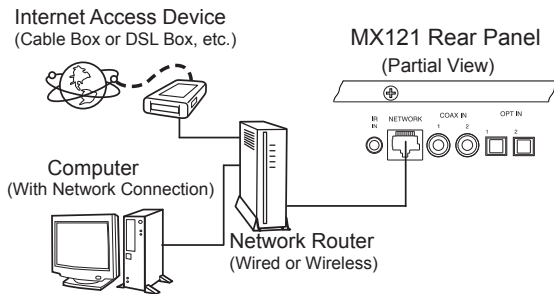

Figure 70

For additional information about PC Internet WEB Browser Programs, Computers, PC Network Connections and Settings, please refer to the documentation supplied with your computer and network hardware.

A computer is not needed for Media Streaming, however it is required to Register/Login In/Sign In for some Internet Media Streamers including McIntosh's own special site. In return for registering, the Internet Media Streamers usually provide easier use, access to other information or additional functioning.

Before registering at the McIntosh (vTuner) Site,

please look up the MAC Address (unique Identification Number [ID] for each MX121) as it will be entered in the "ID" field as part of the registering process. Refer to the "Setup Section" on page 16 in the "Setup Section" for how to navigate thru the On-Screen Menu System. The following is the path to the MAC Address location:

1. Press the MENU Push-button.
2. Select menu item "Manual Setup"
3. Select menu item "Network Setup"
4. Select menu item "Network information"

The On-Screen Display Indicates the MAC Address. Below is the URL Addresses for McIntosh (vTuner) and is accessible via your computer using an Internet Web Browser: <http://www.radiomcintosh.com>.

Provide the necessary information and spend a few minutes selecting the type of music you are interested in hearing. The McIntosh vTuner Site stores your selections and that information will now be available to the MX121 when NET/USB input is selected. Perform the following steps to access the McIntosh Site:

1. Press the NET/USB Push-button twice and then select "Internet Radio". Refer to figure 71.
2. Select "radiomcintosh.com", followed by selecting "Favorites". Refer to figures 72 and 73.

While at the radiomcintosh.com (vTuner) site a new Favorite Folder was created and named "My Favorites 1". Refer to figure 74. Also at the same time three Streaming Selections were added including "101.nu Pop Classical Music". Refer to figure 75.

3. Select "My Favorites 1" followed by selecting "101.nu Pop Classical Music". Refer to figure 76. Within about ten seconds music from "101.nu Pop Classical Music" Internet Radio should start Streaming. The MX121 has the ability store into Preset



Figure 71



Figure 72

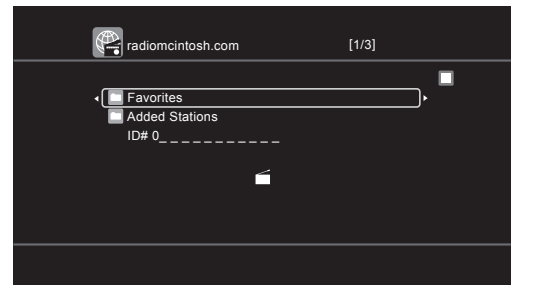

Figure 73

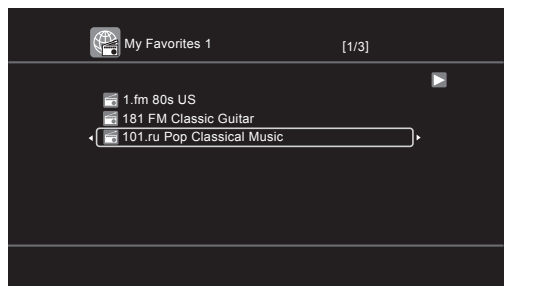

Figure 74

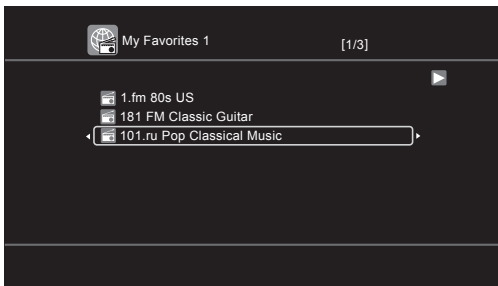

Figure 75

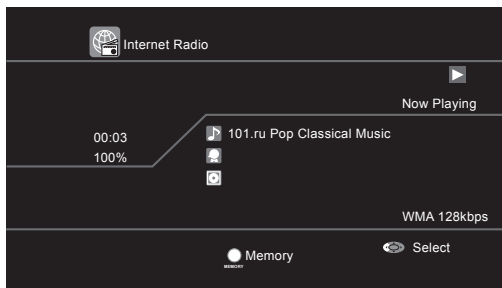

Figure 76

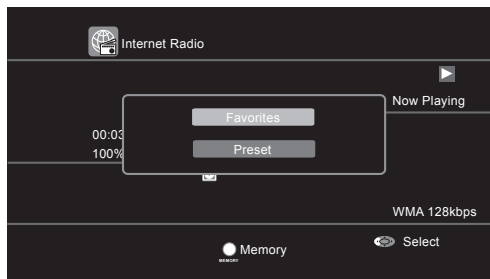

Figure 77

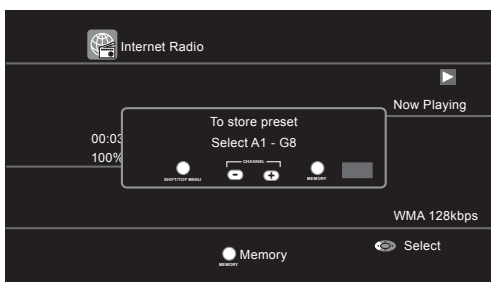

Figure 78

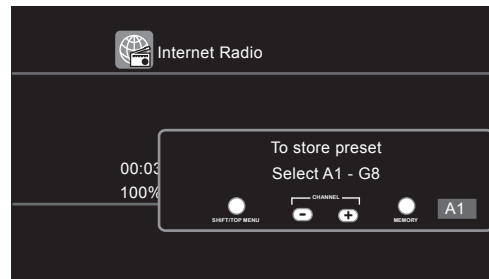

Figure 79

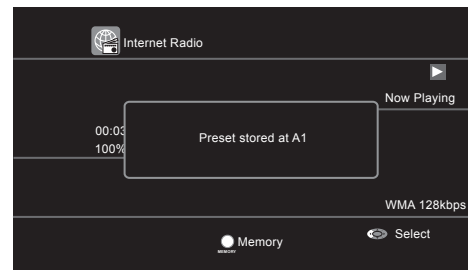

Figure 80

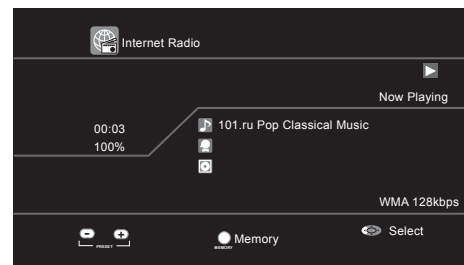

Figure 81

Memory up to 56 Internet Radio Stations for quick recall. To enter a Internet Radio Station perform the following steps:

4. Press the MEMORY Push-button. Refer to figure 77. Then select “Preset”. Refer to figure 78.
5. Using the SHIFT Push-button to select the desired Preset Group (A thru G) followed by CHANNEL + and - Push-button to select the Preset Number desired within the Group (1 thru 8). Referring to figure 79, notice the Preset Group selected is “A” and the Preset Number is “1” for an indication of A1.
6. Press the MEMORY push-button to enter the desired Internet Radio Station Preset. Refer to figure 80.

Once Presets have been entered into memory they can be recalled by using the PRESET + and - Push-buttons. Refer to figure 81.

Accessing the Internet, con't

Pandora® Internet Radio

Pandora® is free personalized internet radio that helps you discover new music you'll love mixed in with music you already know. You can instantly listen to your own personalized radio stations that are created by simply entering a favorite artist, song, comedian or genre. When you first listen to Pandora®, it is necessary to subscribe to a Pandora® account at the Pandora® homepage on your PC and register this machine. See the Pandora® website for details. Pandora® radio is not available in all countries.

Note: Only the MX121s sold in North America are pre-setup to access Pandora® and will synchronize with your music selection list previously entered at the Pandora® Web Site by using your computer.

Setting up access to Pandora® Internet Radio is similar to the method previously used to set up the McIntosh (vTuner) Site. To access Pandora® using the MX121 perform the following steps:

1. Press the NET/USB Push-button twice on the Remote Control. The Front Panel Information Display will now indicate NET/USB and the TV/Monitor will now display the NET/USB the first navigation page. Refer to figure 71.
2. Using the Remote Control first select "Pandora" followed by pressing the ENTER Push-button. Refer to figure 82.
3. Select "I am new to Pandora" and press the ENTER Push-button. Write down the "activation code" as it will be used in the next step to setup a new Pandora® Account. Refer to figure 83.
4. Using your computer go to the Pandora®/McIntosh web site: Below is the URL Address and is accessible via your computer using an Internet Web Browser: <http://www.pandora.com/mcintosh>.

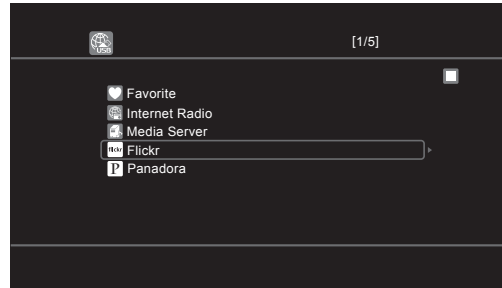

Figure 71

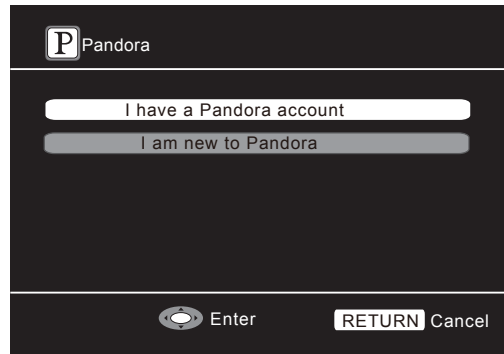

Figure 82

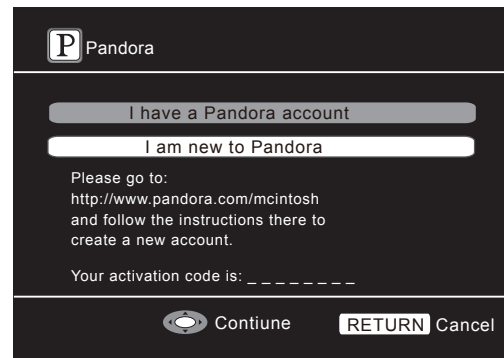

Figure 83

5. Follow the instructions to set up a new account with Pandora® using the previously obtained activation code. Also write down the E-mail Address and Password as it will be needed in step 8.
6. Referring to figure 83 select "I have a Pandora account" then press the ENTER Push-button.
7. Referring to figure 84 press the ENTER Push-button SEARCH/INFO Push-Button to bring up the On-Screen Key Board. Refer to figure 85.
8. Enter the E-mail Address and Password previously entered at Pandora® Web Site. Then select OK.
9. After a few moments an On-Screen Window similar to figure 87 will appear and music will start to play based on your initial choice made when the Pandora® Account was setup.

To create a new radio station perform the following:

10. Select "New Station". Refer to figure 86.
- Note: The word "Radio" is added to the end of a file name and your original radio station is created.*

To search for a Song or Artist perform the following:

11. Enter the Song/Artist Name using the keypad or use the Directional Push-buttons to search for the desired Song or Artist.

Note: If an exact match is not found, music with a similar rhythm or sound will start to play.

To listen randomly to stations perform the following:

12. Using the directional Push-buttons to highlight "Quick Mix" then press the ENTER Push-button.

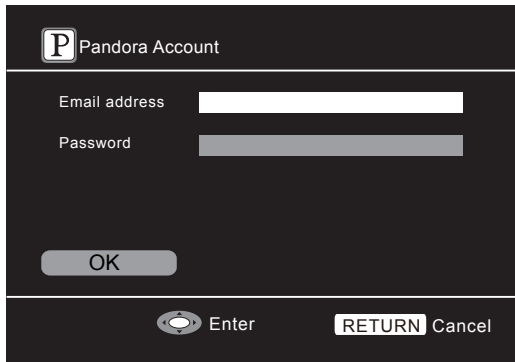

Figure 84



Figure 85

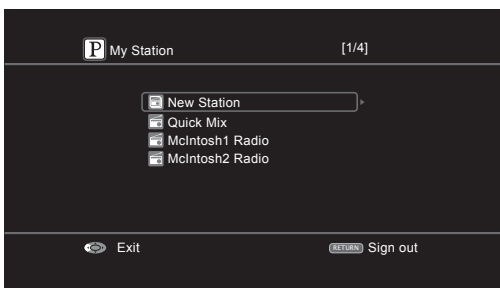

Figure 86

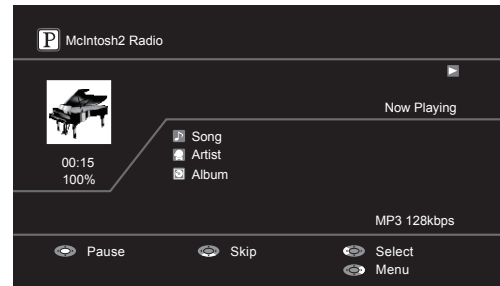

Figure 87

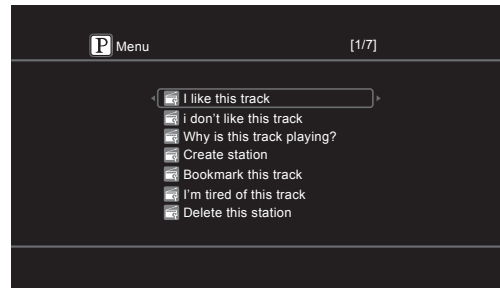



Figure 88

During playback of a song, a Menu/Help can be displayed allowing various additional options by pressing the ► Directional Push-button. Refer to figure 88.

I like this track

Press when you like the track that is being played. It will return to the Play Screen. And  (Thumbs up) icon is displayed.

I don't like this track

Press when you don't like the track that is being played. It will return to the Play Screen. And  (Thumbs down) icon is displayed and Pandora® will skip to the next track.

Why is this track playing?

Displays the reason why Pandora® selected this track.

Create station

Creates a Station for the Track or Artist being played.

Bookmark this track

Bookmarks the track currently being played. You can check your bookmarks at Pandora.com. For details, see the Pandora® FAQ at <http://blog.pandora.com/faq/>.

I'm tired of this track

Press when you don't like the track that is being played. The track will not be played for 1 month.

Delete this station

Press when you want to delete the station that is being played.

Note: You can Skip up to 6 Tracks per Station, per hour. Even if you run out of Skips, you can give a Track a "thumbs down". The track will keep playing, but Pandora® will still use feedback to personalize your radio station. You can create up to 100 New Stations (radio stations).

Accessing the Internet, con't

Last.fm

Last.fm learns what you love and it's a great way to discover new music. With the MX121 you can create a free Last.fm profile keeping track of all the songs you hear. When at the Last.fm web site you can see your top music charts, view thousands of reviews, biographies and artwork, and get recommendations for local performances you won't want to miss.

With an affordable subscription you can enjoy an endless choice of personalized ad-free radio stations. Check out www.last.fm/subscribe today for more details. Your subscription also gives you access to Last.fm radio on a great range of music products.

Last.fm radio is not available in all countries. Please check www.last.fm/hardware for more information. You'll also need a subscription. Get one today at www.last.fm/subscribe.

Note: Only the MX121s sold in Europe are pre-setup to access Last.fm and will synchronize with your music selection list previously entered at the Last.fm Web Site by using your computer.

To access Last.fm using the MX121 perform the following steps:

1. Press the Push-button twice.
2. Press the MENU Push-button, then select "Manual Setup" followed by selecting "Network Setup". Refer to the MX121 Menu separate folded sheet "MX121-Menu-6" and figure 89.
3. Select "Last.fm Display" and then change the setting from "Hidden" to "Display". Refer to figure 90.
4. Press the MENU Push-button to exit the Setup Menu.
5. Press the NET/USB Push-button twice.
6. Referring to figure 92 select Last.fm.
7. Repeat Step 2.

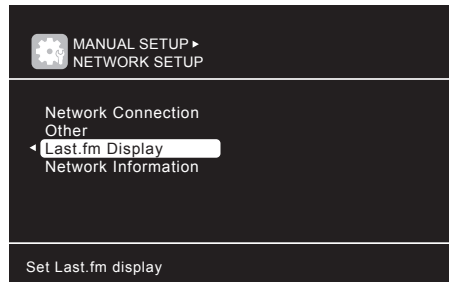

Figure 89

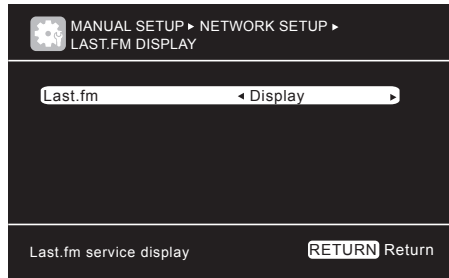

Figure 90

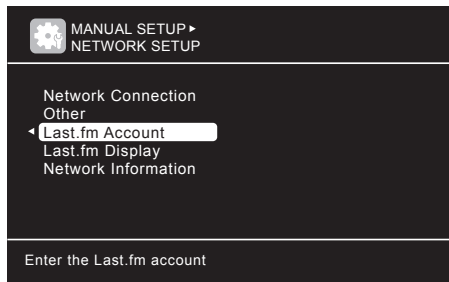

Figure 91

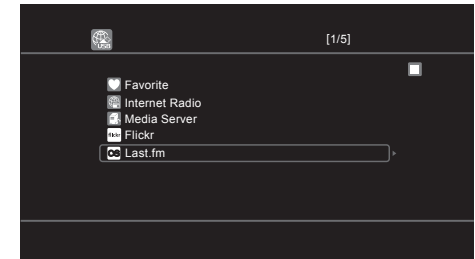

Figure 92

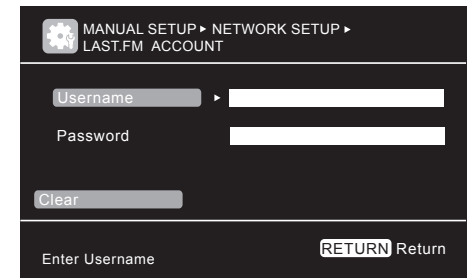

Figure 93



Figure 94

8. Select Last.fm account and press the ENTER Push-button. Refer to figure 91.
9. Referring to figure 93 enter a Username and Password, then highlight OK and press the ENTER Push-button.
10. Press the MENU Push-button to exit the Setup Menu.
11. Press the NET/USB Push-button twice.
12. Select Last.fm and press the ENTER Push-button.
13. Select a Station and press the ENTER Push-button to start Playback. Refer to figure 95.

During playback of a song, a Menu can be displayed allowing various additional options by pressing the ► Directional Push-button. Refer to figure 96.

Love this track

Loving tracks improves your Last.fm recommendations, and you can optionally share them on popular social networks.

Ban this track

If you ban a track, we won't play it again. You can undo this on the Last.fm website.

Scrobbling

Scrobbling sends the tracks you played to your Last.fm account. You can see charts of the music you've been listening to, get recommendations for new music and events in your area and share your listening tastes with your friends. You can turn this service on or off using this option. The more you scrobble, the better your recommendations will become.

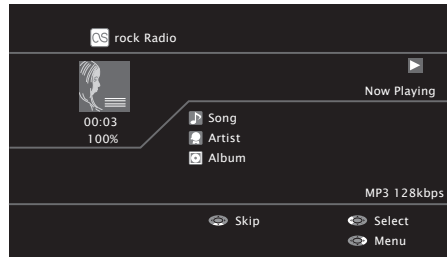

Figure 95

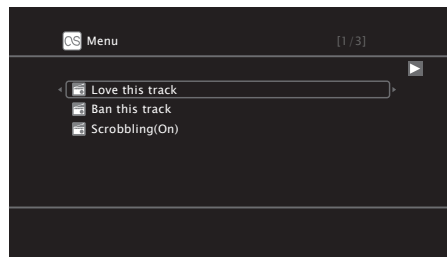
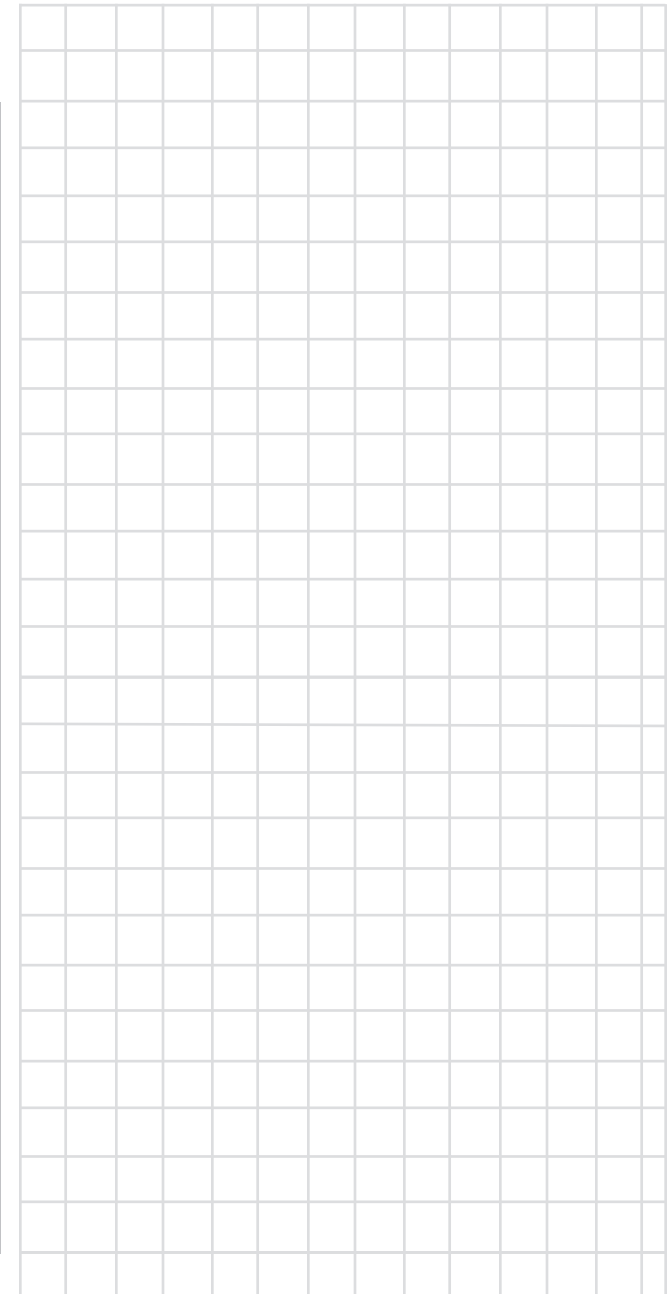

Figure 96



Accessing the Internet, con't

Flickr

The Flickr Web Site allows the viewing of photographs shared by particular users, or all of the photographs shared on Flickr.

To access Flickr using the MX121 perform the following steps:

1. Press the NET/USB Push-button twice on the Remote Control. The Front Panel Information Display will now indicate NET/USB and the TV/Monitor will now display the NET/USB the first navigation page. Refer to figure 97.



Figure 97

2. Using the Remote Control first select “Flickr” followed by pressing the ENTER Push-button. Refer to figure 98.

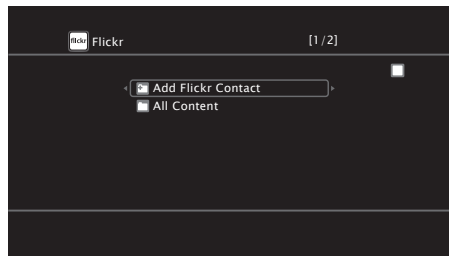

Figure 98

3. Select “Add Flickr Contact” and press the ENTER Push-button.
4. Press the SEARCH Push-button and enter a user name. Select the user name just entered and press the ENTER Push-Button. Refer to figure to 99.

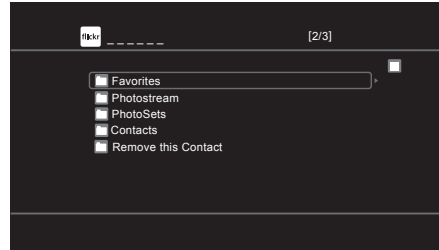

Figure 99

Select from the available choices On-Screen:

Favorites

Displays the favorite photographs of the specified user.

Photostream

Displays a list of shared photographs.

PhotoSets

Displays the folder (photograph album) list.

Contacts

Displays a Username registered for Flickr Contact by a particular user.

Remove this Contact

Deletes a user from Flickr Contact.

To view all the Photos on the Flickr Web Site perform the following steps:

5. Select “All Content” followed by pressing the ENTER Push-button. Refer to figure 100.

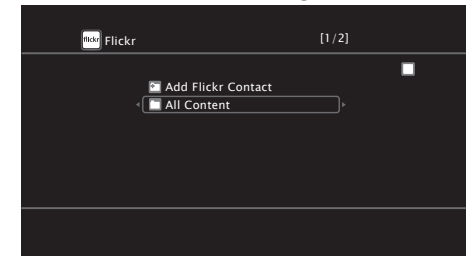

Figure 100

6. Select the desired category and press the Enter Push-Button. Then use the ▲ or ▼ Directional Push-button to select the next available photo.

Resetting the Microprocessors

In the highly unlikely event the Controls and/or Push-buttons on the MX121 become non-response, it may become necessary to reset the microprocessors in the MX121. Perform the following steps to take corrective action:

REMOVE POWER:

1. Remove the AC Power Cord from the Rear Panel of the MX121.
2. Having waited at least 15 to 20 seconds after removing AC Power, now reattach the AC Power Cord to the Rear Panel of the MX121.

SAVING USER PREFERENCE SETTINGS:

Before resetting the Microprocessors the next two steps will first save all the user preference settings.

Note: If it is desired to return the MX121 to factory default settings, skip steps 3, 4 and 6.

3. Press the STANDY/BY Push-button.
4. After the MX121 has gone through the normal startup process, press and hold in the ENTER and SLEEP Push-buttons for at least 5 seconds. Refer to figure 101.



Figure 101

During the time the two push-buttons are pressed the MX121 Front Panel Display should first indicate "MEMORY SAVING" followed by "Complete".

RESETTING THE MICROPROCESSORS:

With having first saved the user preference settings it's now time to reset the Microprocessors.

5. Referring to figure 102, Press and hold in the



Figure 102

STANDY/BY Push-button along with the Surround Mode AUTO and MANUAL Push-buttons.

The MX121 Front Panel Information should have all of the display segments illuminated and after the entire display flashes ON and OFF several times release the three push-buttons. The MX121 should now go through its normal startup, it might be necessary to press the STANDBY/BY Push-button to start up the MX121.

It's now time to restore the previously saved user preference settings. Perform the following steps:

6. Referring to figure 103, press and hold in the



Figure 103

MENU and SLEEP Push-buttons for at least 5 seconds.

During the time the two push-buttons are pressed the MX121 Front Panel Display should first indicate "MEMORY LOAD" followed by "Complete".

Updating the MX121 Firmware

Occasionally, McIntosh might make available Firmware Updates for the MX121. These Updates would be from the McIntosh Computer Server via the MX121 Network Connection.

It would be advisable to have your McIntosh Dealer perform the MX121 Update for you. It is important the network connection be a direct cable connection-between the MX121 and the Network Router with Internet access. This will help to insure a successful Firmware Update. Do not use a WIFI wireless type of connection. Perform the following steps:

1. Press the MENU Push-button, select "Manual Setup", "Options" and then "Firmware Update". Refer to figure 104.

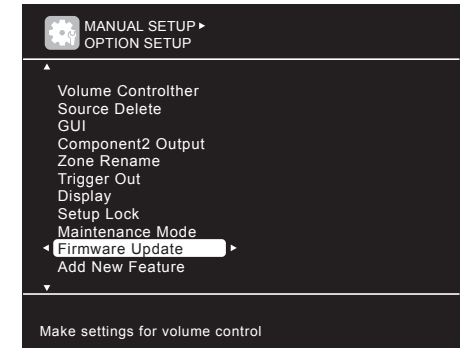

Figure 104

2. Select "Check for Update" and press the "ENTER" Push-button. Refer to figure 105.

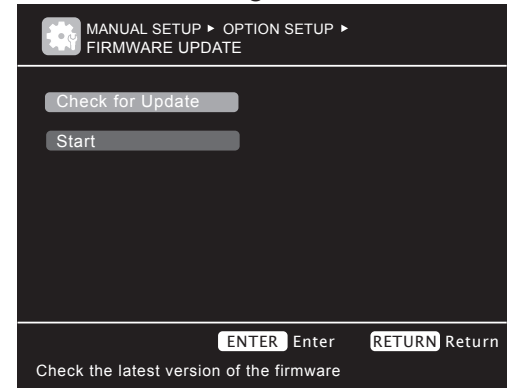

Figure 105

If there is a Firmware Update available, please keep in mind the Update Process might take a hour or longer to perform, depending on the speed of the network connection.

3. If there is an Update available select "Start" and press "ENTER" and follow the On-Screen Instruction. **DO NOT SWITCH POWER OFF TO THE MX121 OR ATTEMPT TO OPERATE IT DURING THE UPDATE PROCESS UNLESS INSTRUCTED TO DO SO.**
4. After the update process is completed verify normal operation.



Audio Specifications

Unless otherwise noted, the below MX121 Specifications were taken with Audyssey bypassed and manual Tone/EQ set to flat setting.

Frequency Response

±0.5dB from 20Hz-20,000Hz

Total Harmonic Distortion

0.005% maximum from 20Hz to 20,000Hz at rated output

Signal To Noise Ratio

Phono: 86dB below 10mV input (A Weighted)
High Level: 96dB below rated output (A Weighted)

Rated Output Voltage

2.5V Unbalanced Outputs (Main Zone)
5.0V Balanced Outputs (Main Zone)

Maximum Voltage Output

6V Unbalanced
12V Balanced

Output Impedance

220 ohms

Input Impedance

Phono: 47k Ohms, 65pf
High Level: 20k Ohms Unbalanced and Balanced

Sensitivity for Rated Output

Phono: 4.5mV
High Level: 450mV Unbalanced
900mV Balanced

Maximum Input Signal

Phono: 50mV
High Level: 4.5V Unbalanced and Balanced

Tone Controls

Bass Control: ±6dB at 30Hz
Treble Control: ±6dB at 10,000Hz

Video Specifications

Signal System

NTSC/PAL

HDMI

Version 1.4 (includes support for Deep Color, x.v.Color, Auto Lipsync, Audio Return Channel and HDMI Component Control)

Scaling

Analog Video Inputs scaled to a 1080P Digital Signal

Component Video Output Level

Y Output Level 1.0Vp-p (75 OHM)
 P_B/C_B Output Level 0.7Vp-p (75 OHM)
 P_R/C_R Output Level 0.7Vp-p (75 OHM)

Composite Video Output Level

1Vp-p (75 OHM)

General Specifications

Power Requirements

Field AC Voltage conversion of the MX121 is not possible. The MX121 is factory configured for one of the following AC Voltages:

100 Volts, 50/60Hz at 75 watts
110 Volts, 50/60Hz at 75 watts
120 Volts, 50/60Hz at 75 watts
220 Volts, 50/60Hz at 75 watts
230 Volts, 50/60Hz at 75 watts
240 Volts, 50/60Hz at 75 watts
Standby, less than 0.5 watt

Note: Refer to the rear panel of the MX121 for the correct voltage.

Overall Dimensions

Width is 17-1/2 inches (44.45cm)
Height is 7-5/8 inches (19.37cm) including feet
Depth is 19-1/2 inches (49.53cm) including the Front Panel, Knobs, Rear Panel Connections and USB Drive

Weight

30 pounds (13.6Kg) net, 54 pounds (24.5Kg) in shipping carton

Shipping Carton Dimensions

Width is 25 inches (63.5cm)
Height is 18-3/8 inches (46.67cm)
Depth is 28 inches (71.12cm)

Packing Instructions

In the event it is necessary to repack the equipment for shipment, the equipment must be packed exactly as shown below. It is very important that the four plastic feet are attached to the bottom of the equipment.

This will ensure the proper equipment location on the bottom pad. Failure to do this will result in shipping damage.

Use the original shipping carton and interior parts only if they are all in good serviceable condition. If a shipping carton or any of the interior part(s) are needed, please call or write Customer Service Department of McIntosh Laboratory. Refer to page 4. Please see the Part List for the correct part numbers.

Quantity	Part Number	Description
1	034256	Shipping carton only
4	033887	End cap
2	034493	Spacer pad
1	033697	Inside carton only
1	033725	Inner carton top pad
1	034301	Bottom pad
2	034446	Foam plug
4	017937	Plastic foot
4	400159	#10-32 x 3/4" screw
4	404080	#10 Flat washer
1	034499	Accessory Box
1	034486	Slotted foam
1	034487	Divider foam

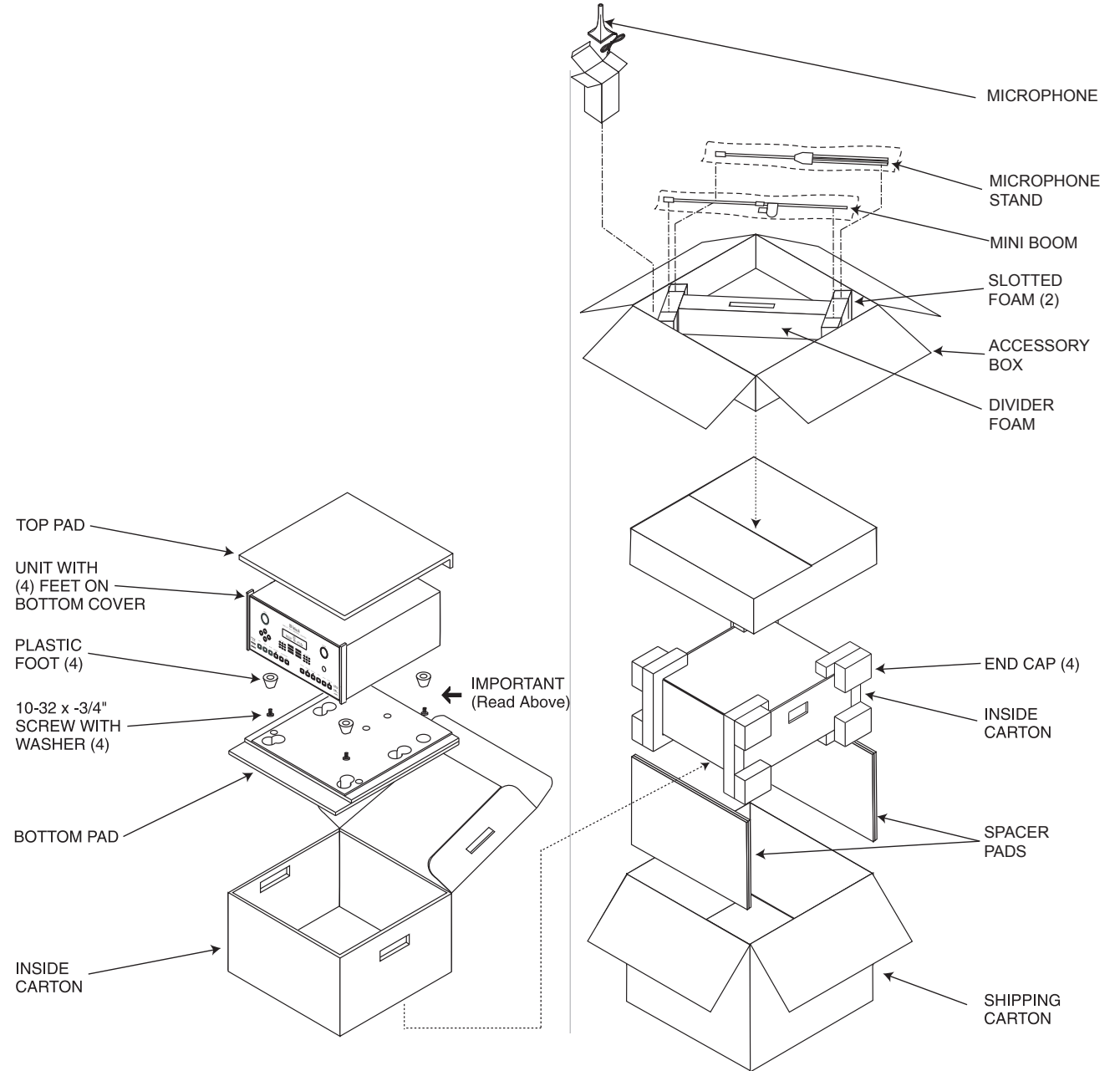



McIntosh Laboratory, Inc.
2 Chambers Street
Binghamton, NY 13903
www.mcintoshlabs.com

The continuous improvement of its products is
the policy of McIntosh Laboratory Incorporated
who reserve the right to improve design without
notice.

Printed in the U.S.A.