



P-Channel Enhancement Mode Power MOSFET

Description

The MX2301A uses advanced trench technology to provide excellent $R_{DS(ON)}$, low gate charge and operation with gate voltages as low as 1.8V.

This device is suitable for use as a load switch or in PWM applications.

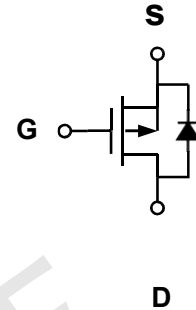

General Features

- $V_{DS} = -20V$, $I_D = -3A$
- @ $V_{GS} = -2.5V$ $R_{DS(ON)}(Typ.) = 110m\Omega$
- @ $V_{GS} = -4.5V$ $R_{DS(ON)}(Typ.) = 85m\Omega$

- High power and current handling capability
- Lead free product is acquired
- Surface mount package

Schematic diagram

Application

- PWM applications
- Load switch

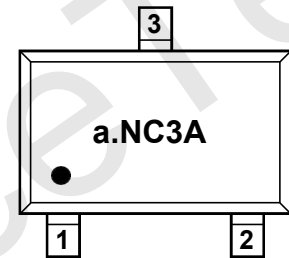

Marking and pin assignment SOT-23 (TOP VIEW)

Ordering Information

Part Number	Marking	Storage Temperature	Package	Devices Per Reel
MX2301A	a.NC3A	-55°C to +150°C	SOT-23	3000

Absolute Maximum Ratings (TA=25°C unless otherwise noted)

Parameter	Symbol	Limit	Unit
Drain-Source Voltage	V_{DS}	-20	V
Gate-Source Voltage	V_{GS}	± 12	V
Drain Current-Continuous	I_D	-3	A
Drain Current -Pulsed (Note 1)	I_{DM}	-10	A
Maximum Power Dissipation	P_D	1	W
Operating Junction and Storage Temperature Range	T_J, T_{STG}	-55 To 150	°C



Electrical Characteristics (TA=25°C unless otherwise noted)

Parameter	Symbol	Condition	Min	Typ	Max	Unit
OFF Characteristics						
Drain-source breakdown voltage	BV_{DSS}	$V_{GS}=0V, I_D=-250\mu A$	-20	-	-	V
Zero gate voltage drain current	I_{DSS}	$V_{DS}=-20V, V_{GS}=0V$	-	-	-1	μA
Gate-body leakage	I_{GSS}	$V_{DS}=0V, V_{GS}=\pm 12V$	-	-	± 100	nA
ON Characteristics						
Gate threshold voltage	$V_{GS(th)}$	$V_{DS}=V_{GS}, I_D=-250\mu A$	-0.45	-0.7	-1.0	V
Drain-source on-state resistance	$R_{DS(ON)}$	$V_{GS}=-4.5V, I_D=-2.5A$	-	85	110	m Ω
		$V_{GS}=-2.5V, I_D=-2A$	-	110	140	
Forward transconductance	g_{fs}	$V_{GS}=-5V, I_D=-2.8A$	-	-9.5	-	V
Dynamic Characteristics						
Input capacitance	C_{ISS}	$V_{DS}=-10V, V_{GS}=0V$ $f=1.0MHz$	-	405	-	pF
Output capacitance	C_{OSS}		-	75	-	
Reverse transfer capacitance	C_{RSS}		-	55	-	
Switching Characteristics						
Turn-on delay time	$t_{D(ON)}$	$V_{DD}=-10V$ $I_D=-1A$ $V_{GS}=-4.5V$ $R_{GEN}=10oh$ m	-	11	-	ns
Rise time	t_r		-	35	-	
Turn-off delay time	$t_{D(OFF)}$		-	30	-	
Fall time	t_f		-	10	-	
Total gate charge	Q_g	$V_{DS}=-10V, I_D=-3A$ $V_{GS}=-2.5V$	-	3.3	-	nC
Gate-source charge	Q_{gs}		-	0.7	-	
Gate-drain charge	Q_{gd}		-	1.3	-	
DRAIN-SOURCE DIODE CHARACTERISTICS						
Diode forward voltage	V_{SD}	$V_{GS}=0V, I_s=-4.2A$	-	-	-1.2	V

Notes:

1. Repetitive Rating: Pulse width limited by maximum junction temperature.
2. Surface Mounted on FR4 Board, $t \leq 10$ sec.
3. Pulse Test: Pulse Width $\leq 300\mu s$, Duty Cycle $\leq 2\%$.
4. Guaranteed by design, not subject to production

Thermal Characteristics

Thermal Resistance junction-to ambient	$R_{th JA}$	125	$^{\circ}C/W$
--	-------------	-----	---------------



TYPICAL ELECTRICAL AND THERMAL CHARACTERISTICS

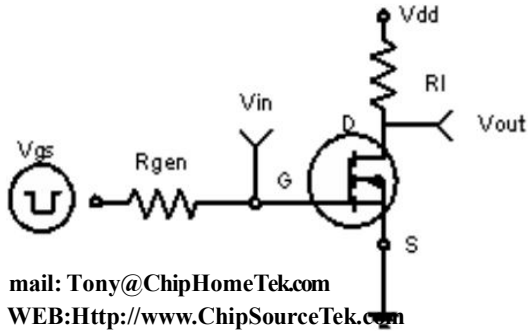

mail: Tony@ChipHomeTek.com
WEB: [Http://www.ChipSourceTek.com](http://www.ChipSourceTek.com)

Figure 1: Switching Test Circuit

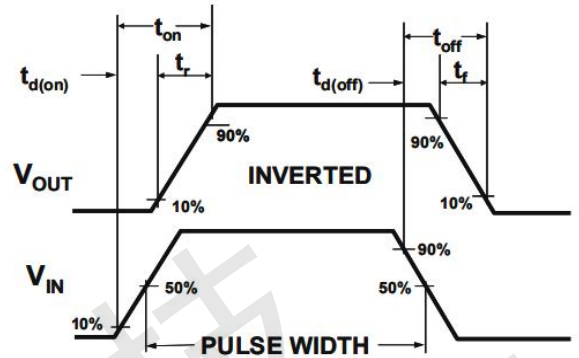

Figure 2: Switching Waveforms

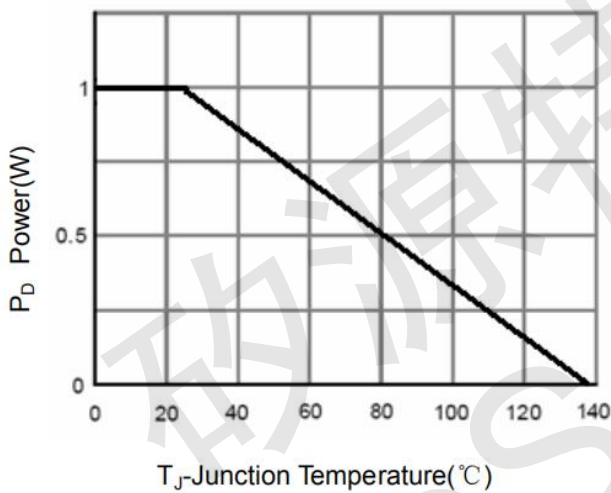

Figure 3 Power Dissipation

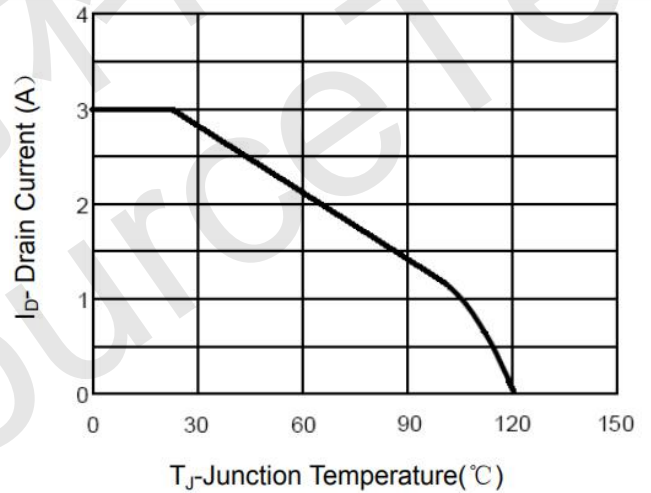

Figure 4 Drain Current

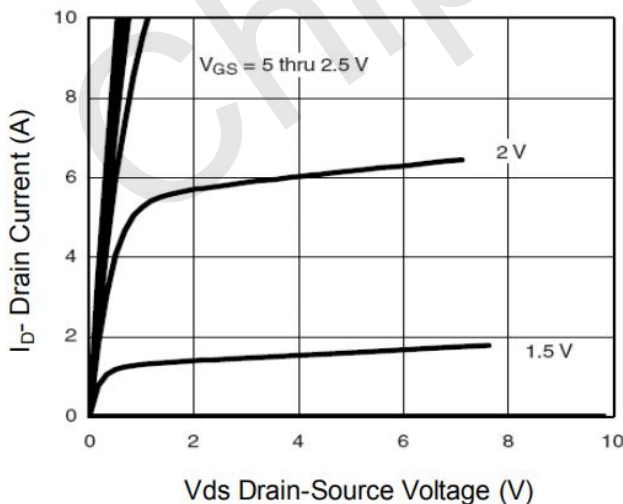

Figure 5 Output CHARACTERISTICS

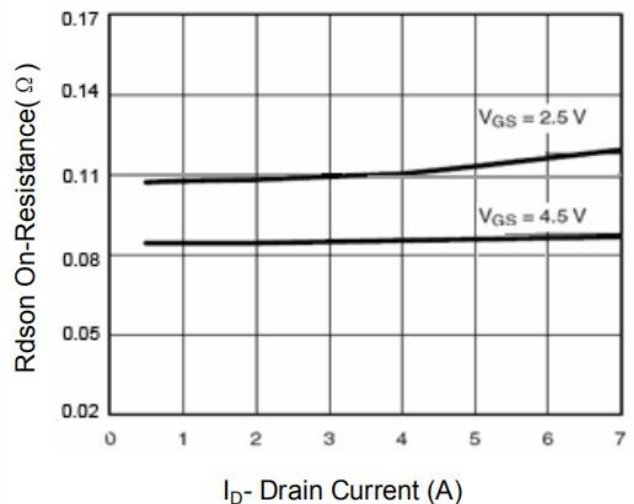
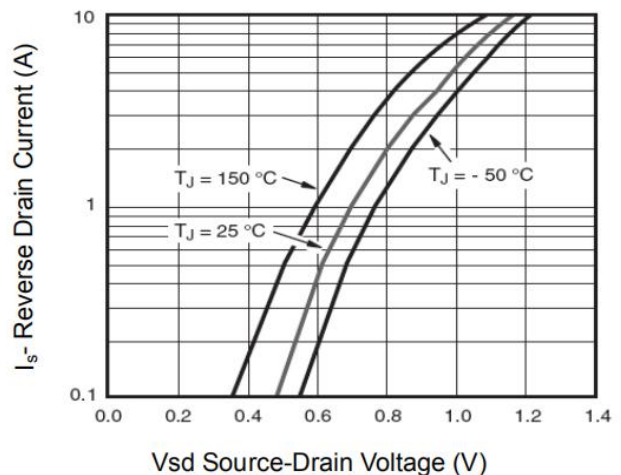
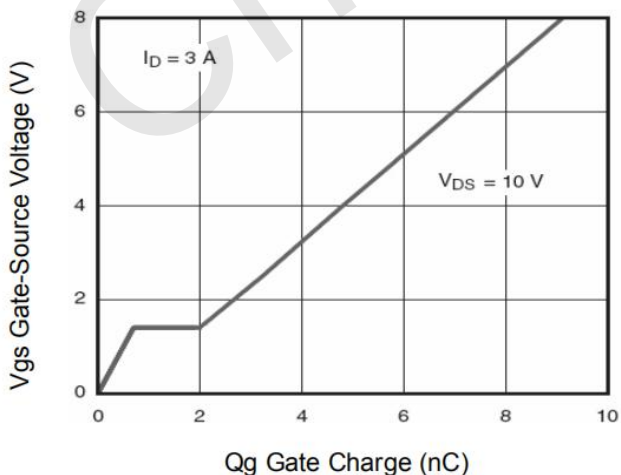
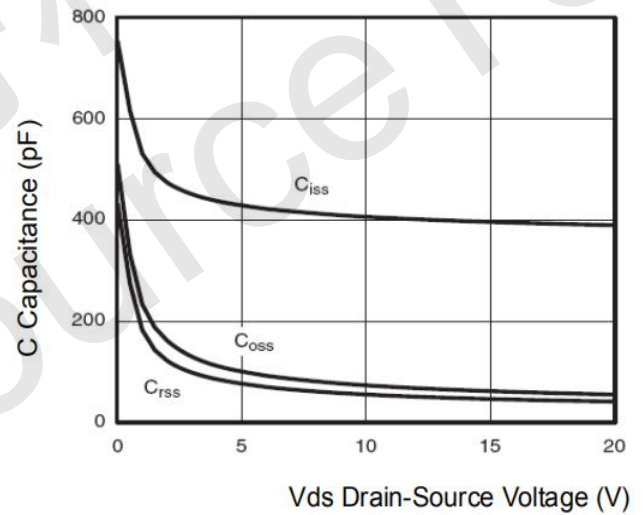
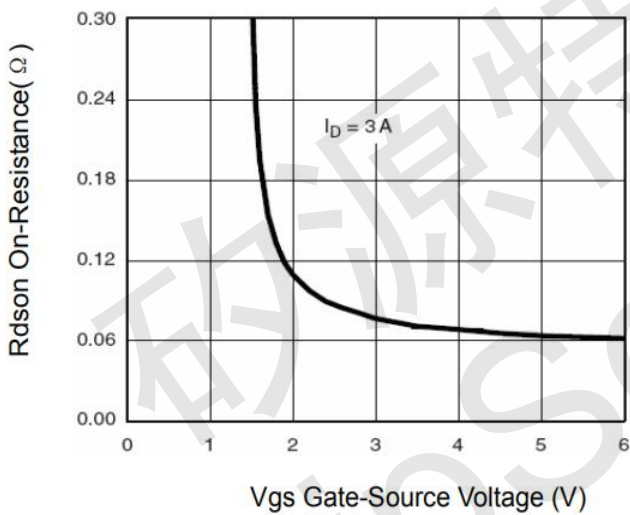
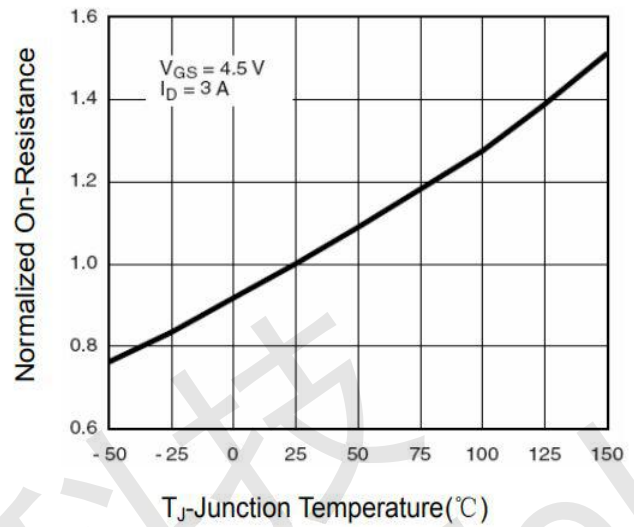
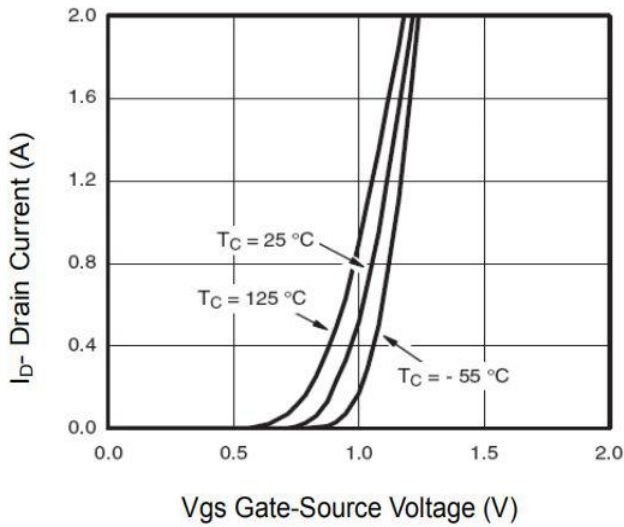

Figure 6 Drain-Source On-Resistance



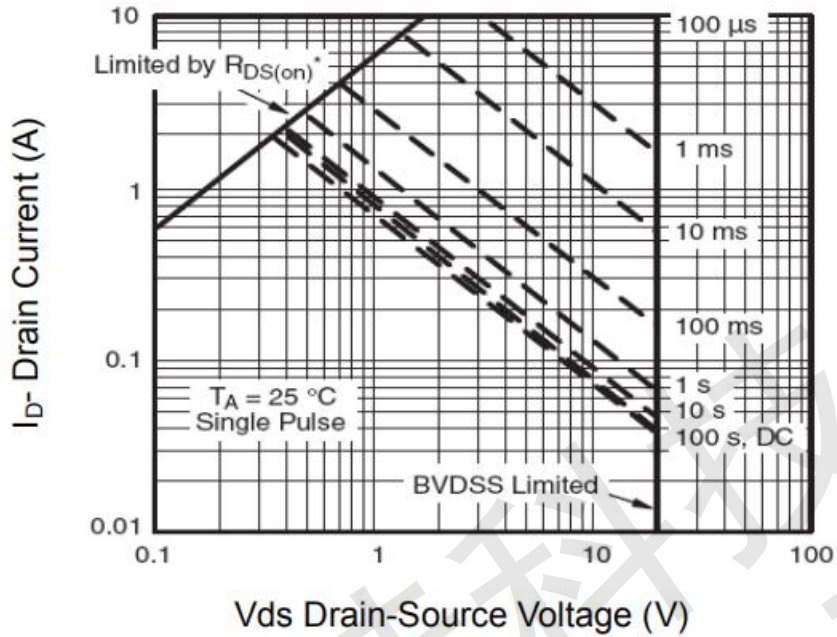

Figure 13 Safe Operation Area

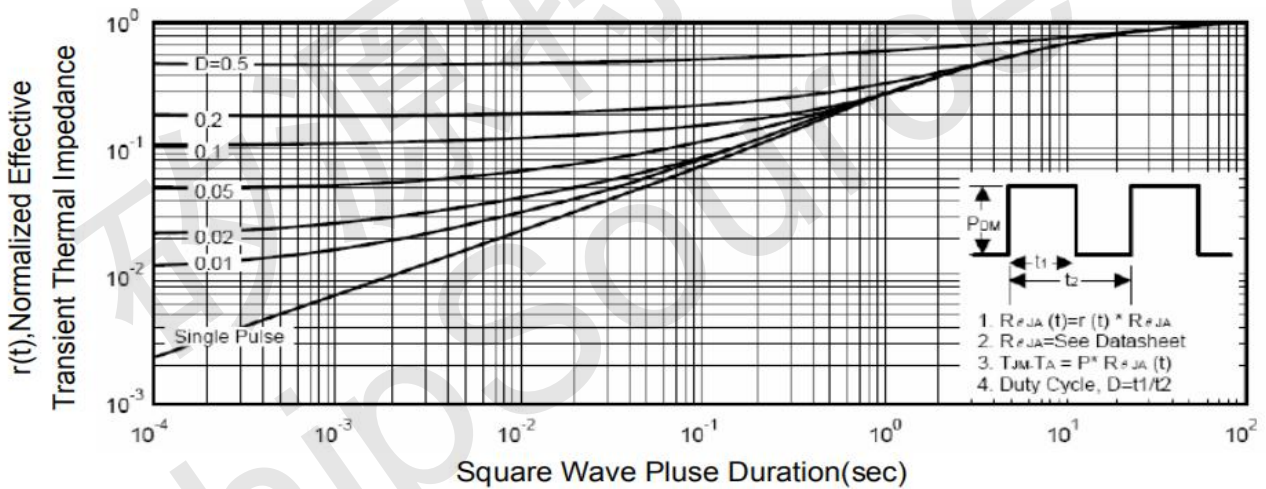

Figure 14 Normalized Maximum Transient Thermal Impedance



Package Information

SOT-23

Dimensions in Millimeters (UNIT:mm)

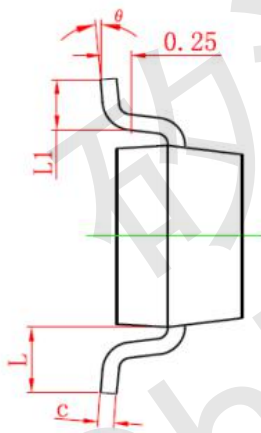
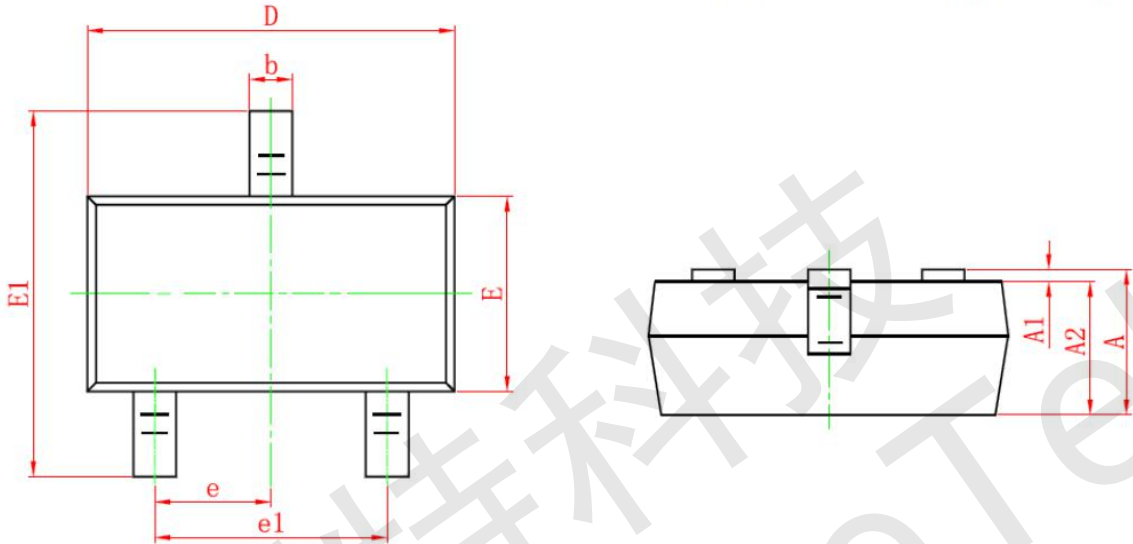

Symbol	Dimensions in Millimeters	
	MIN.	MAX.
A	0.900	1.150
A1	0.000	0.100
A2	0.900	1.050
b	0.300	0.500
c	0.080	0.150
D	2.800	3.000
E	1.200	1.400
E1	2.250	2.550
e	0.950TYP	
e1	1.800	2.000
L	0.550REF	
L1	0.300	0.500
θ	0°	8°

NOTES

1. All dimensions are in millimeters.
2. Tolerance $\pm 0.10\text{mm}$ (4 mil) unless otherwise specified
3. Package body sizes exclude mold flash and gate burrs. Mold flash at the non-lead sides should be less than 5 mils.
4. Dimension L is measured in gauge plane.
5. Controlling dimension is millimeter, converted inch dimensions are not necessarily exact.