



N-Channel Enhancement Mode Power MOSFET **MXD6888**

DESCRIPTION

The MXD6888 is N-channel MOS Field Effect Transistor designed for high current switching applications. Rugged E_{AS} capability and ultra low $R_{DS(ON)}$ is suitable for PWM, load switching especially for E-Bike controller applications.

GENERAL FEATURES

- $V_{DS}=60V$, $I_D=80A$
 $R_{DS(ON)}(Typ.)=6.8m\Omega$ @ $V_{GS}=10V$
- Special Designed for E-Bike Controller Application
- Ultra Low On-Resistance
- High UIS and UIS 100% Test

APPLICATION

- Power Switching Application
- Hard Switched and High Frequency Circuits
- Uninterruptible Power Supply

PINOUT

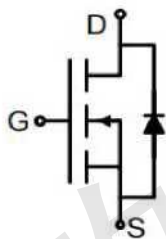

Schematic diagram

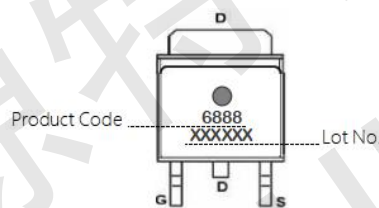

Marking and pin Assignment

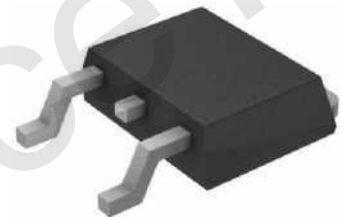

TO-252-2L top view

KEY PERFORMANCE PARAMETERS

Parameter	Value	Unit
V_{DS} @ $T_A=25^\circ C$	60	V
$R_{DS(ON)}(Typ.)$ @ $V_{GS}=10V$	6.8	$m\Omega$
$Q_g(Typ.)$	56	nC
I_D @ $T_A=25^\circ C$	80	A
P_D @ $T_A=25^\circ C$	75	W
T_J, T_{STG}	-55 to 175	$^\circ C$

PACKAGE INFORMATION

Package	TO-252-2L
---------	-----------

**ABSOLUTE MAXIMUM RATINGS(TA=25°C unless otherwise noted)**

Parameter	Symbol	Limit	Unit
Drain-Source Voltage (V _{GS} =0V)	V _{DS}	60	V
Gate-Source Voltage (V _{DS} =0V)	V _{GS}	±20	V
Drain Current (DC) at T _C =25°C	I _{D(DC)}	80	A
Drain Current (DC) at T _C =100°C	I _{D(DC)}	65	A
Drain Current-Continuous@ Current-Pulsed (Note1)	I _{DM(pluse)}	260	A
Peak Diode Recovery Voltage	dv/dt	8	V/ns
Maximum Power Dissipation(T _C =25°C)	P _D	75	W
Derating Factor		0.5	W/°C
Single Pulse Avalanche Energy (Note 2)	E _{AS}	300	mJ
Operating Junction and Storage Temperature Range	T _J , T _{STG}	-55 to 175	°C

Notes 1 . Repetitive Rating: Pulse width limited by maximum junction temperature

2. E_{AS} condition: T_J=25°C, V_{DD}=33V, V_G=10V

**THERMAL RESISTANCE**

Parameter	Symbol	Max.	Unit
Thermal Resistance, Junction-to-Case	R _{θJC}	2.34	°C/W



ELECTRICAL CHARACTERISTICS (TA=25°C unless otherwise noted)

Parameter	Symbol	Condition	Min	Typ	Max	Unit
-----------	--------	-----------	-----	-----	-----	------

On/Off Characteristics

Drain-Source Breakdown Voltage	BV_{DSS}	$V_{GS}=0V, I_D=-250\mu A$	60	-	-	V
Zero Gate Voltage Drain Current	I_{DSS}	$V_{DS}=60V, V_{GS}=0V$	-	-	1	μA
Gate-Body Leakage Current	I_{GSS}	$V_{GS}=\pm 20V, V_{DS}=0V$	-	-	± 100	nA
Gate Threshold Voltage	$V_{GS(th)}$	$V_{DS}=V_{GS}, I_D=250\mu A$	2	-	4	V
Drain-Source On-State Resistance	$R_{DS(ON)}$	$V_{GS}=10V, I_D=40A$	-	6.8	8.2	m Ω

Dynamic Characteristics

Forward Transconductance	g_{FS}	$V_{DS}=10V, I_D=15A$	15	-	-	S
Input Capacitance	C_{iss}	$V_{DS}=25V, V_{GS}=0V,$ $F=1.0MHz$	-	2873	-	pF
Output Capacitance	C_{oss}		-	252	-	pF
Reverse Transfer Capacitance	C_{rss}		-	205	-	pF
Total Gate Charge	Q_g	$V_{DS}=50V, I_D=40A,$ $V_{GS}=10V$	-	56	-	nC
Gate-Source Charge	Q_{gs}		-	10	-	nC
Gate-Drain Charge	Q_{gd}		-	16	-	nC

Switching Characteristics

Turn-on Delay Time	$t_{d(on)}$	$V_{DD}=30V, I_D=2A,$ $R_L=15\Omega$ $V_{GS}=10V, R_{GEN}=2.5\Omega$	-	14.5	-	nS
Turn-on Rise Time	t_r		-	24	-	nS
Turn-Off Delay Time	$t_{d(off)}$		-	45	-	nS
Turn-Off Fall Time	t_f		-	22	-	nS

Source-Drain Diode Characteristics

Diode Forward Voltage	V_{SD}	$T_J=25^\circ C, V_{GS}=0V,$ $I_S=40A$	-	0.89	0.99	V
Diode Forward Current	I_{DS}		-	-	60	A
Reverse Recovery Time	t_{rr}	$T_J=25^\circ C, I_F=75A,$	-	22	-	nS
Reverse Recovery Charge	Q_{rr}	$di/dt=100A/\mu s$	-	27	-	nC
Forward Turn-On Time	t_{on}	Intrinsic turn-on time is negligible (turn-on is dominated by L_S+L_D)				



TYPICAL PERFORMANCE CHARACTERISTICS

1) E_{AS} Test Circuits

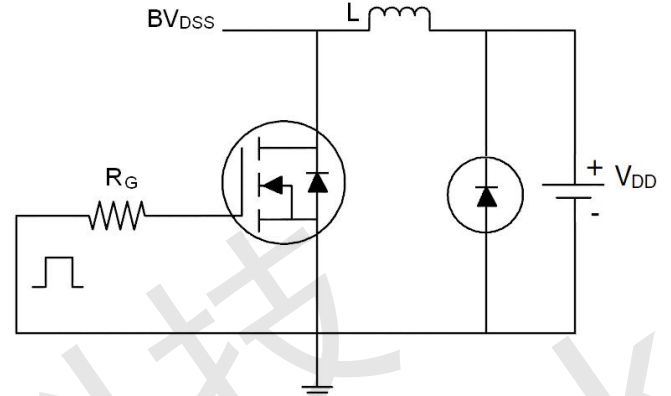
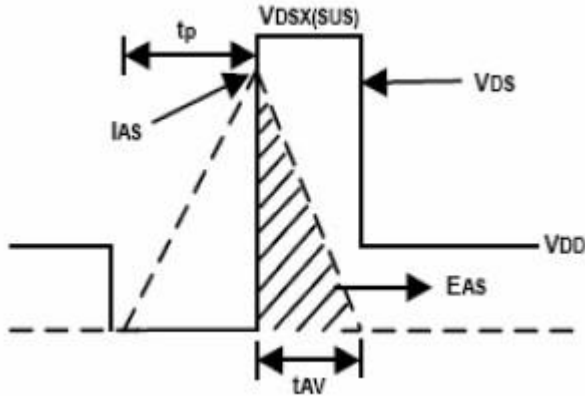

2) Gate Charge Test Circuit:

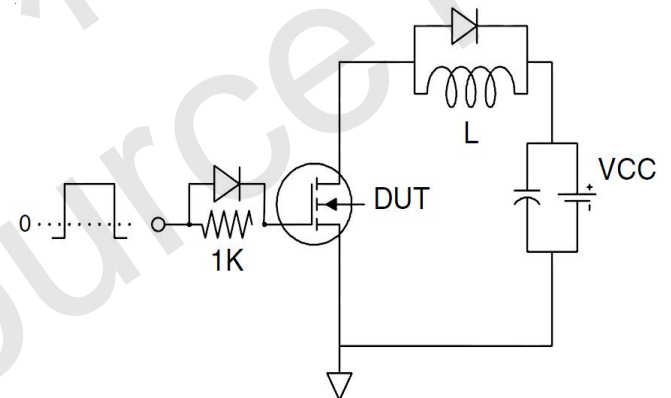
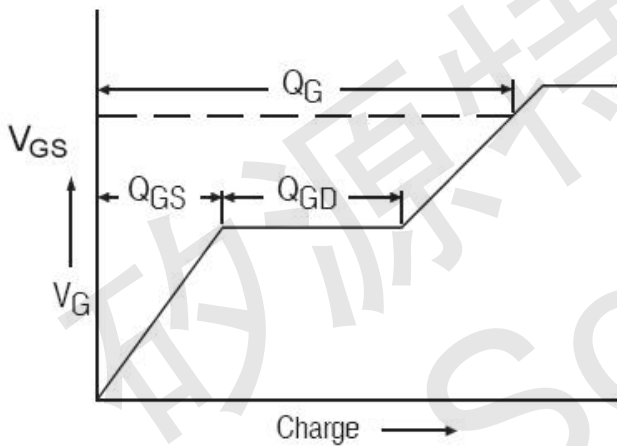

3) Switch Time Test Circuit:

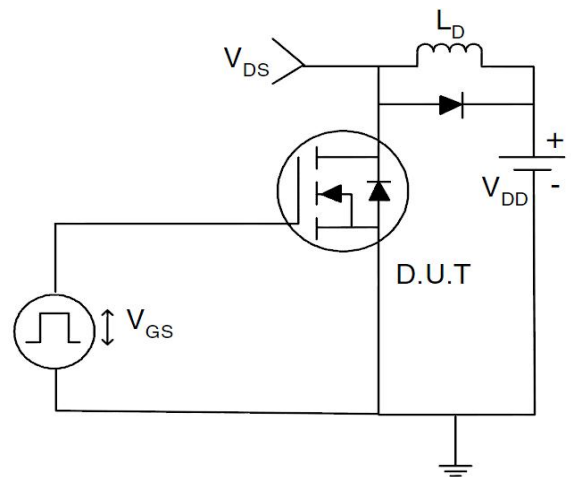
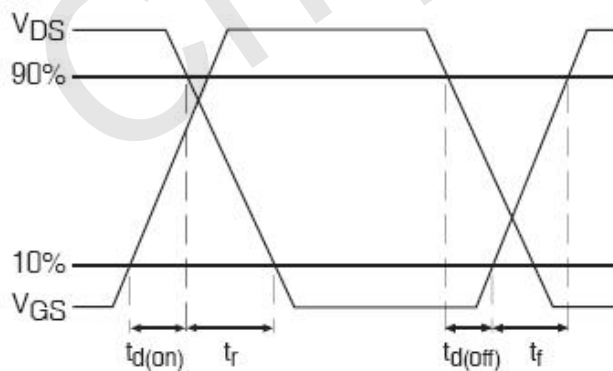



TYPICAL PERFORMANCE CHARACTERISTICS

Figure1. Output Characteristics

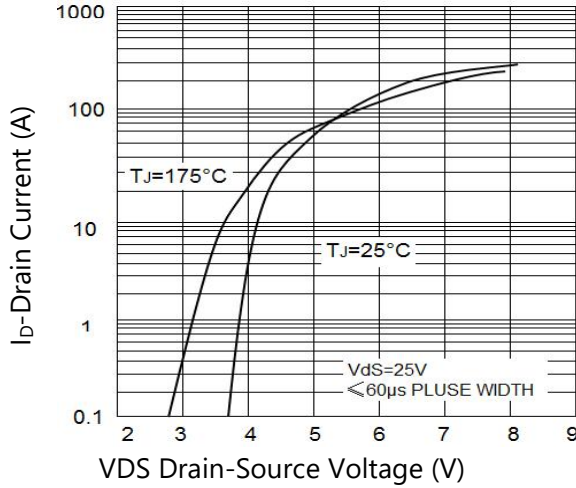

Figure2. Transfer Characteristics

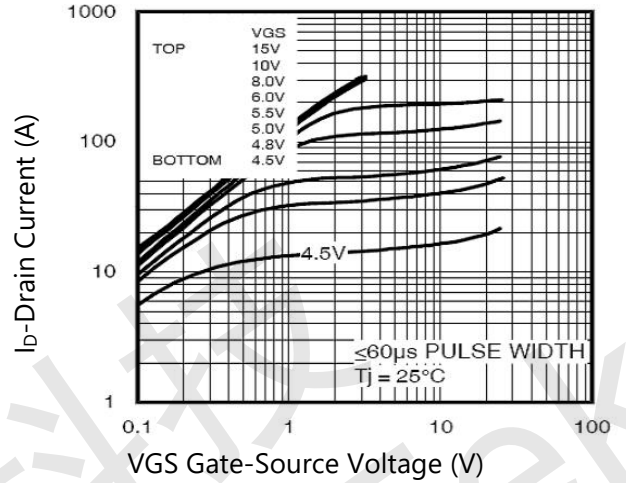

Figure3. BV_{DSS} vs Junction Temperature

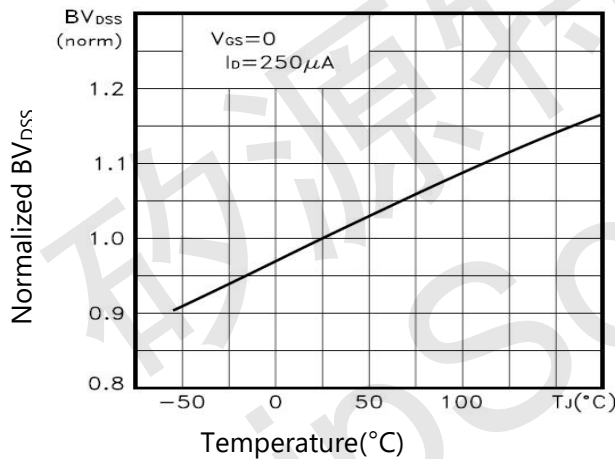

Figure4. I_D vs Junction Temperature

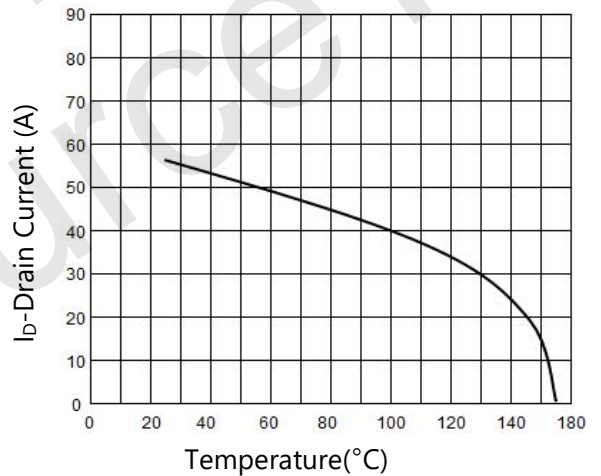

Figure5. $V_{GS(th)}$ vs Junction Temperature

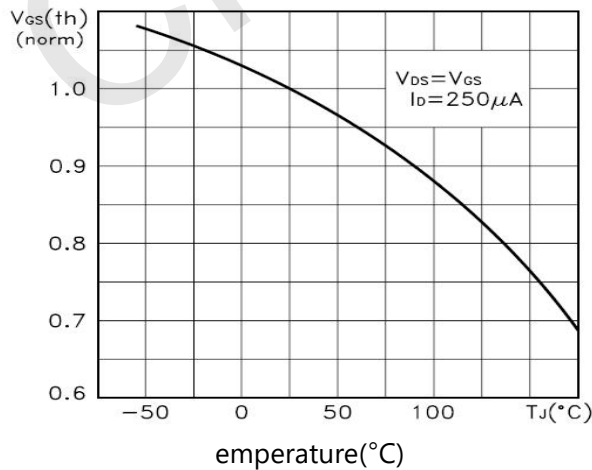
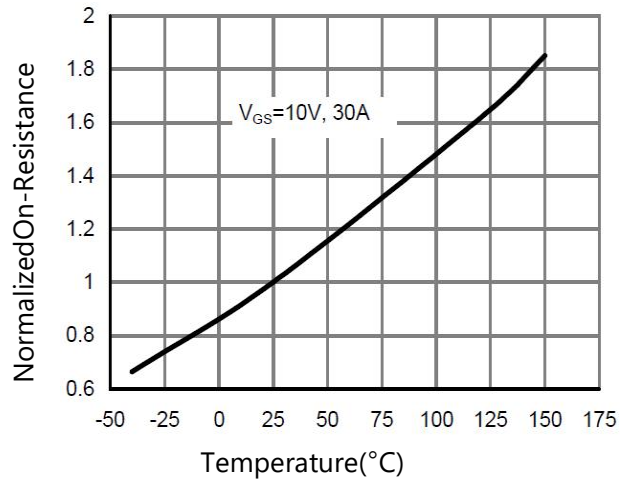

Figure6. R_{dson} Vs Junction Temperature





TYPICAL PERFORMANCE CHARACTERISTICS

Figure7. Gate Charge

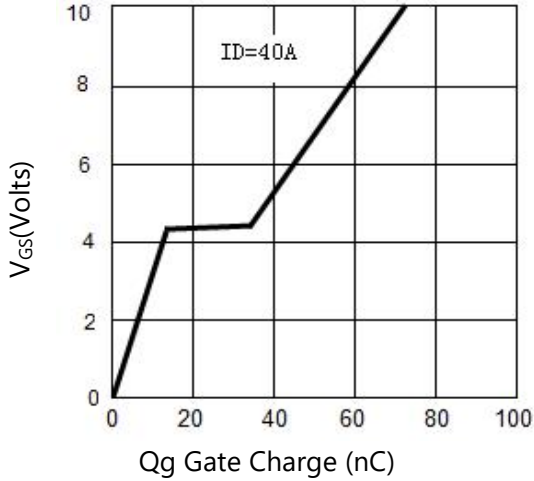

Figure8. Capacitance vs VDS

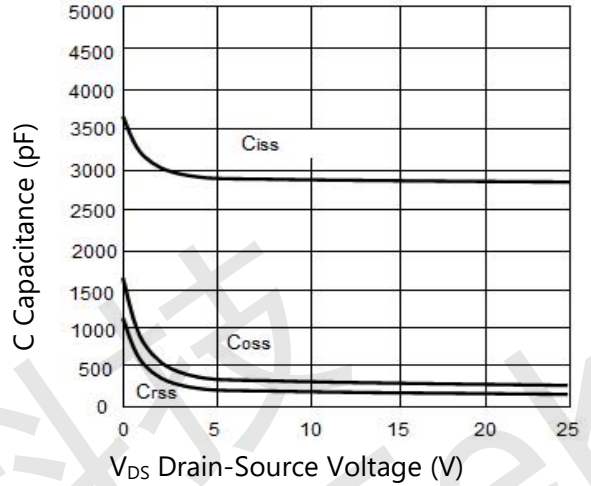

Figure9. Source-Drain Diode Forward

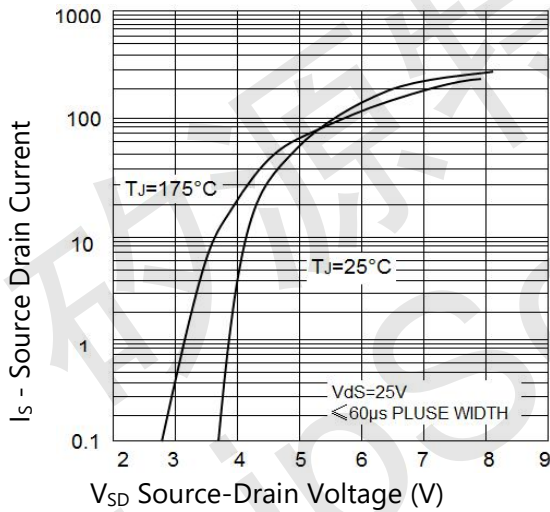

Figure10. Safe Operation Area

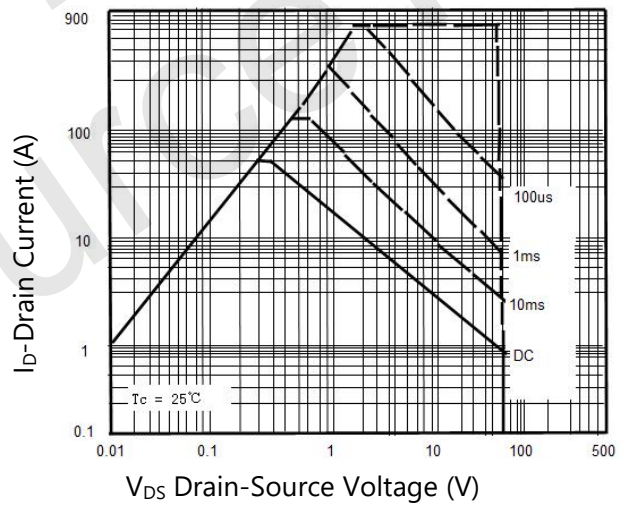
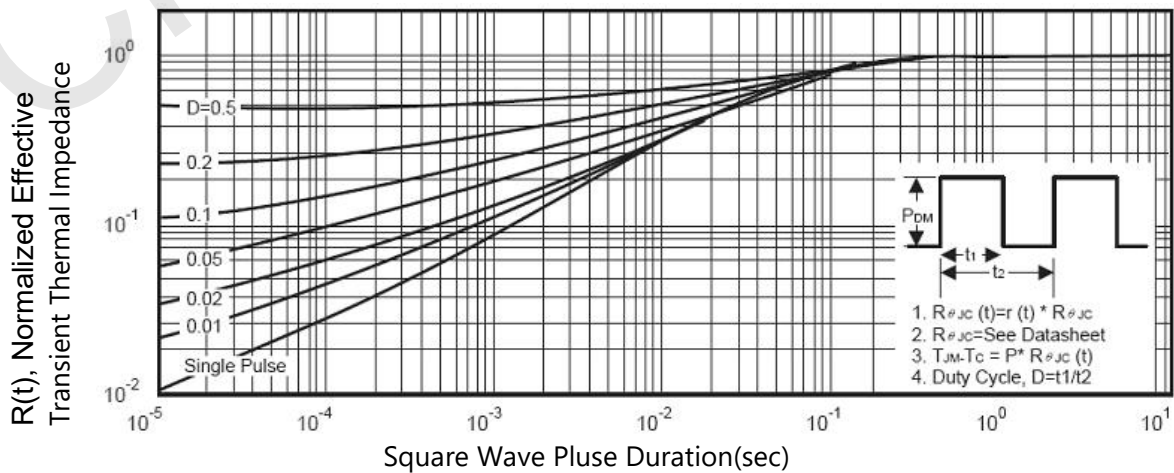

Figure11. Normalized Maximum Transient Thermal Impedance





PACKAGE INFORMATION

TO-252-2L

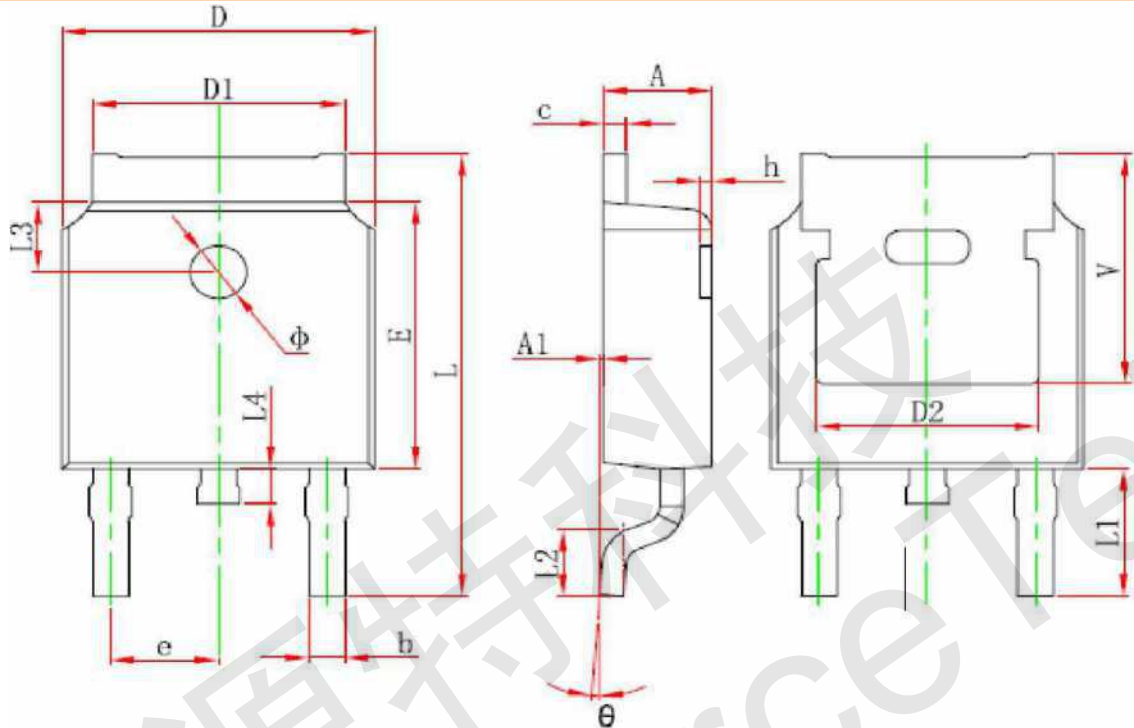

Symbol	Dimensions In Millimeters		Dimensions In Inches	
	Min.	Max.	Min.	Max.
A	2.200	2.400	0.087	0.094
A1	0.000	0.127	0.000	0.005
b	0.660	0.860	0.026	0.034
c	0.460	0.580	0.018	0.023
D	6.500	6.700	0.256	0.264
D1	5.100	5.460	0.201	0.215
D2	4.830 REF.		0.190 REF.	
E	6.000	6.200	0.236	0.244
e	2.186	2.386	0.086	0.094
L	9.800	10.400	0.386	0.409
L1	2.900 REF.		0.114	REF.
L2	1.400	1.700	0.055	0.067
L3	1.600 REF.		0.063 REF.	
L4	0.600	1.000	0.024	0.039
0	1.100	1.300	0.043	0.051
e	0°	8°	0°	8°
h	0.000	0.300	0.000	0.012
V	5.350 REF.		0.211 REF.	