

MINIATURE RELAY

1 POLE—1 to 2 A (FOR SIGNAL SWITCHING)

MZ SERIES

■ FEATURES

- Subminiature size
- Standard and high sensitivity types available
- UL, CSA recognized
- FCC rules and regulations part 68
—Dielectric strength 1,500 V between coil and contacts
- High reliability-bifurcated contacts available
- DIL pitch terminals
- Plastic sealed type

■ ORDERING INFORMATION

[Example] $\frac{MZ}{(a)} \frac{F}{(b)} - \frac{12}{(c)} \frac{W}{(d)} \frac{HG}{(e)} - \frac{K}{(f)} - \frac{U}{(g)}$



(a)	Series Name	MZ : MZ Series
(b)	Dielectric Function	Nil : Standard type F : High dielectric strength type
(c)	Nominal Voltage	Refer to the COIL DATA CHART
(d)	Contact	Nil : 1 A single D : 2 A single (without MZF) W : 1 A bifurcated type
(e)	Coil Type	HG : Standard type (without MZ-D) HS : High sensitivity type (without MZF/MZ-D)
(f)	Enclosure	Nil : Flux free type K : Plastic sealed type
(g)	UL, CSA Standard	Nil : Non UL, • CSA approved type U : UL • CSA approved type

Note: For movable and stationary contact with gold overlay type, add suffix “-OH”.

■ SAFETY STANDARD AND FILE NUMBERS

UL478, 508 (File No. E45026)

C22.2 No. 14 (File No. LR35579)

Please request when the approval markings are required on the cover.

Nominal voltage	Contact rating
1.5 to 48 VDC	0.5 A 120 VAC, 1 A 24 VDC resistive
	1 A 120 VDC, 2 A 30 VDC resistive

MZ SERIES

■ SPECIFICATIONS

Item		Standard			High Sensitivity Type	
		Single		Bifurcated	Single	Bifurcated
		MZ-() D	MZ-() HG	MZ-() WHG	MZ-() HS	MZ-() WHS
Contact	Arrangement	1 form C (SPDT)				
	Material	Gold-overlay silver-alloy	Gold overlay silver-palladium			
	Resistance (initial)	Maximum 100 mΩ (at 1 A 6 VDC)				
	Rating (resistive)	2 A 24 VDC 1 A 120 VAC	1 A 24 VDC 0.5 A 120 VAC			
	Maximum Carrying Current	2 A				
	Maximum Switching Power	120 VA/48 W	60 AV/24 W			
	Maximum Switching Voltage	120 VAC, 60 VDC				
	Maximum Switching Current	2 A	1 A			
	Minimum Switching Load*	1 mA 1 VDC		0.1 mA 100 mVDC	1 mA 1 VDC	0.1 mA 100 mVDC
	Capacitance (at 10 MHz)	Approximately 0.8 pF (between open contacts, adjacent contacts) Approximately 7.5 pF (between coil and contacts)				
Coil	Nominal Power (at 20°C)	0.45 to 0.50 W			0.19 to 0.27 W	
	Operate Power (at 20°C)	0.22 to 0.25 W			0.10 to 0.13 W	
	Operating Temperature	-30°C to +55°C (no frost) (refer to the CHARACTERISTIC DATA)				
Time Value	Operate (at nominal voltage)	Maximum 6 ms				
	Release (at nominal voltage)	Maximum 3 ms				
Insulation	Resistance (at 500 VDC)	Minimum 100 MΩ				
	Dielectric Strength	between open contacts	AC 500 V 1 minute (standard type) AC 1,000 V 1 minute (high dielectric strength type, MZF)			
		between coil and contacts	AC 500 V 1 minute (standard type) AC 1,500 V 1 minute (high dielectric strength type, MZF)			
Surge Strength	1,500 V (between coil and contacts)					
Life	Mechanical	2 × 10 ⁷ operations minimum				
	Electrical (at rating)	1 A 120 VAC 1 × 10 ⁵ ops. min. 2 A 24 VDC 2 × 10 ⁵ ops. min.		0.5 A 120 VAC 2 × 10 ⁵ operations minimum 1 A 24 VAC 5 × 10 ⁵ operations minimum		
Other	Vibration Resistance	Misoperation	10 to 55 Hz (double amplitude of 3.28 mm)			
		Endurance	10 to 55 Hz (double amplitude of 3.28 mm)			
	Shock Resistance	Misoperation	100 m/s ² (11±1 ms)			
		Endurance	1,000 m/s ² (6±1 ms)			
Weight	Approximately 3.5 g					

*1 Minimum switching loads mentioned above are reference values. Please perform the confirmation test with the actual load before production since reference values may vary according to switching frequencies, environmental conditions and expected reliability levels.

MZ SERIES

■ COIL DATA CHART

	MODEL			Nominal voltage	Coil resistance (±10%)	Must operate voltage	Must release voltage	Nominal power
	Single		Bifurcated					
	2 A Type	1 A Type	1 A Type					
Standard Type	MZ-1.5D-(K)	MZ (F)-1.5HG-(K)	MZ-1.5WHG-(K)	1.5 VDC	5 Ω	1.05 VDC	0.08 VDC	450 mW
	MZ- 3 D-(K)	MZ (F)- 3 HG-(K)	MZ- 3 WHG-(K)	3 VDC	20 Ω	2.1 VDC	0.15 VDC	450 mW
	MZ-4.5D-(K)	MZ (F)-4.5HG-(K)	MZ-4.5WHG-(K)	4.5 VDC	45 Ω	3.15 VDC	0.23 VDC	450 mW
	MZ- 5 D-(K)	MZ (F)- 5 HG-(K)	MZ- 5 WHG-(K)	5 VDC	56 Ω	3.5 VDC	0.25 VDC	450 mW
	MZ- 6 D-(K)	MZ (F)- 6 HG-(K)	MZ- 6 WHG-(K)	6 VDC	80 Ω	4.2 VDC	0.3 VDC	450 mW
	MZ- 9 D-(K)	MZ (F)- 9 HG-(K)	MZ- 9 WHG-(K)	9 VDC	180 Ω	6.3 VDC	0.45 VDC	450 mW
	MZ-12 D-(K)	MZ (F)-12 HG-(K)	MZ-12 WHG-(K)	12 VDC	320 Ω	8.4 VDC	0.6 VDC	450 mW
	MZ-18 D-(K)	MZ (F)-18 HG-(K)	MZ-18 WHG-(K)	18 VDC	720 Ω	12.6 VDC	0.9 VDC	450 mW
	MZ-24 D-(K)	MZ (F)-24 HG-(K)	MZ-24 WHG-(K)	24 VDC	1,280 Ω	16.8 VDC	1.2 VDC	450 mW
	MZ-48 D-(K)	MZ (F)-48 HG-(K)	MZ-48 WHG-(K)	48 VDC	4,600 Ω	33.6 VDC	2.4 VDC	500 mW
High Sensitivity Type	MZ-1.5HS-(K)	MZ-1.5WHS-(K)		1.5 VDC	12 Ω	1.05 VDC	0.08 VDC	190 mW
	MZ- 3 HS-(K)	MZ- 3 WHS-(K)		3 VDC	45 Ω	2.1 VDC	0.15 VDC	200 mW
	MZ-4.5HS-(K)	MZ-4.5WHS-(K)		4.5 VDC	100 Ω	3.15 VDC	0.23 VDC	200 mW
	MZ- 5 HS-(K)	MZ- 5 WHS-(K)		5 VDC	120 Ω	3.5 VDC	0.25 VDC	200 mW
	MZ- 6 HS-(K)	MZ- 6 WHS-(K)		6 VDC	180 Ω	4.2 VDC	0.3 VDC	200 mW
	MZ- 9 HS-(K)	MZ- 9 WHS-(K)		9 VDC	400 Ω	6.3 VDC	0.45 VDC	200 mW
	MZ-12 HS-(K)	MZ-12 WHS-(K)		12 VDC	700 Ω	8.4 VDC	0.6 VDC	200 mW
	MZ-15 HS-(K)	MZ-15 WHS-(K)		15 VDC	1,100 Ω	10.5 VDC	0.75 VDC	200 mW
	MZ-18 HS-(K)	MZ-18 WHS-(K)		18 VDC	1,600 Ω	12.6 VDC	0.9 VDC	200 mW
	MZ-24 HS-(K)	MZ-24 WHS-(K)		24 VDC	2,800 Ω	16.8 VDC	1.2 VDC	200 mW
MZ-48 HS-(K)	MZ-48 WHS-(K)		48 VDC	8,500 Ω	33.6 VDC	2.4 VDC	270 mW	

Note: All values in the table are measured at 20°C.

MZ SERIES

CHARACTERISTIC DATA

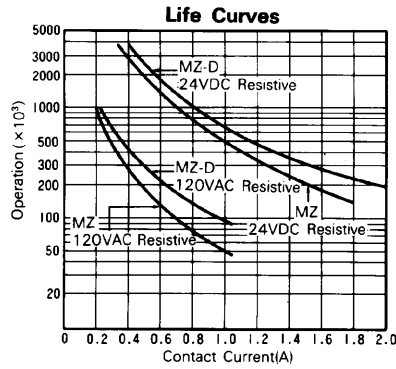
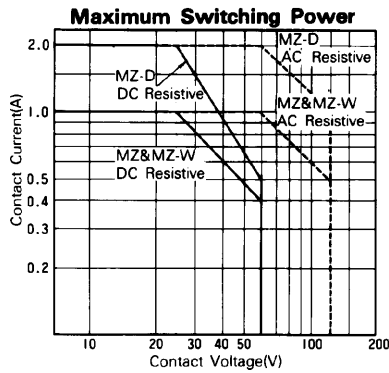
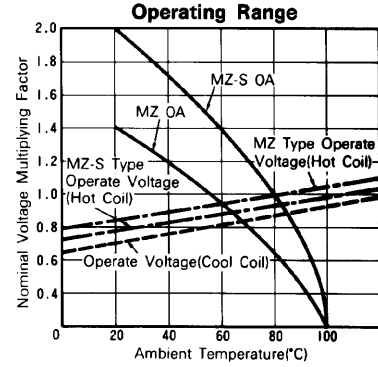
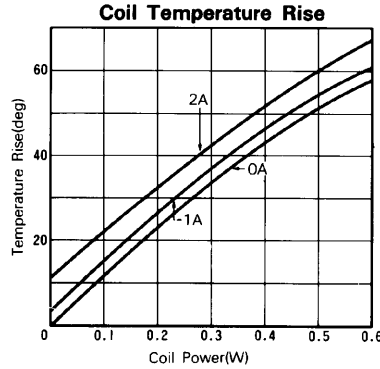
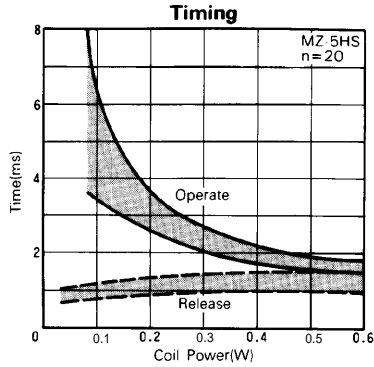

REFERENCE DATA

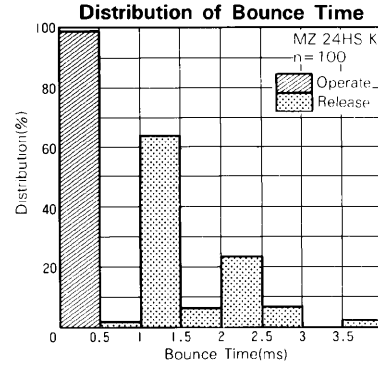
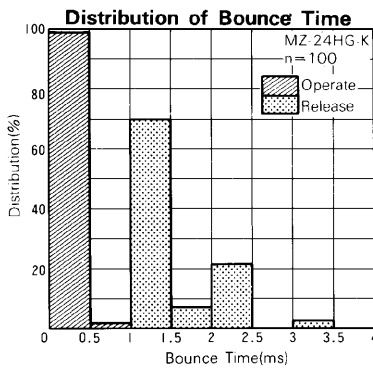
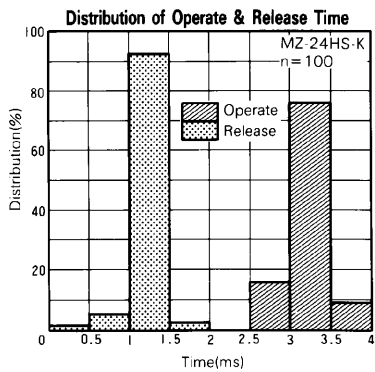
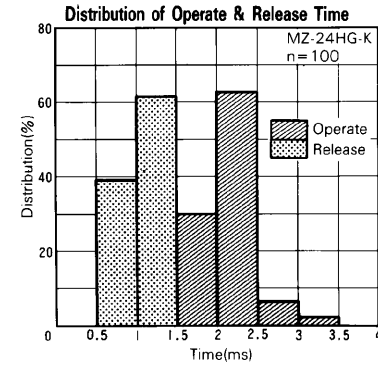
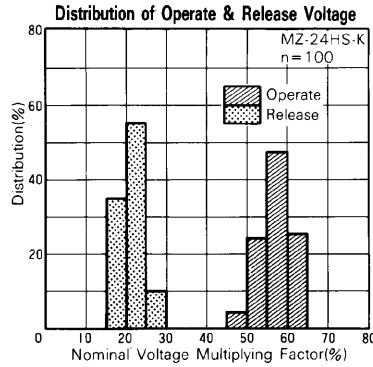
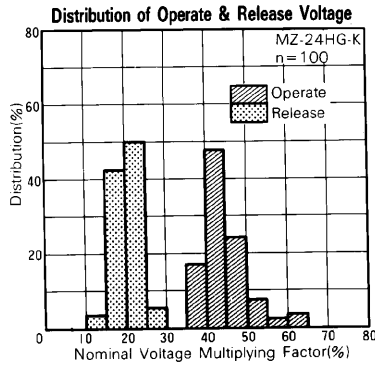

MZ SERIES

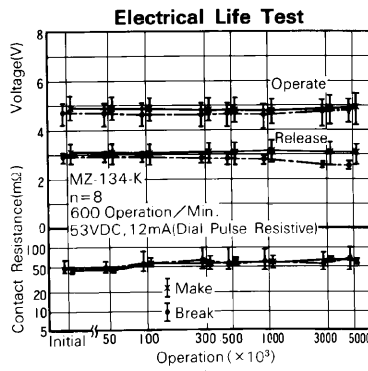
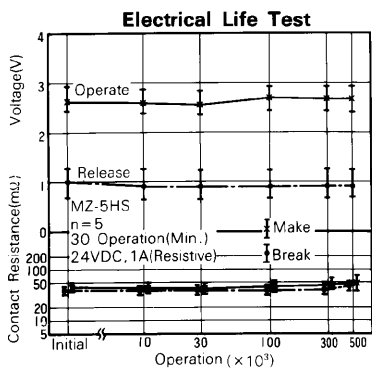
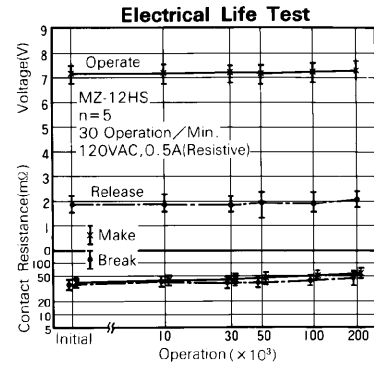
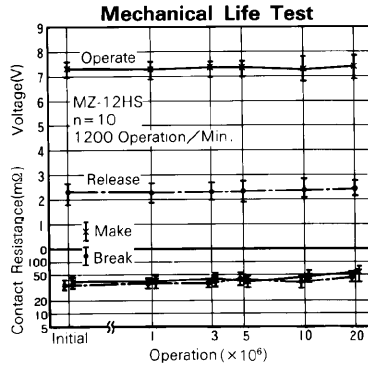
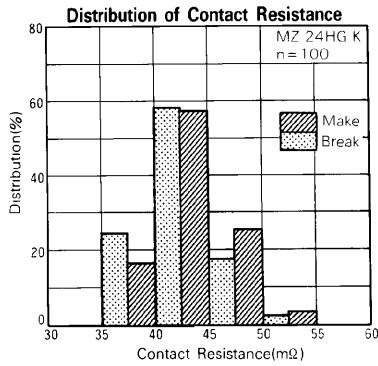

■ DIMENSIONS

● Dimensions

MZ (F) type (Flux free type)

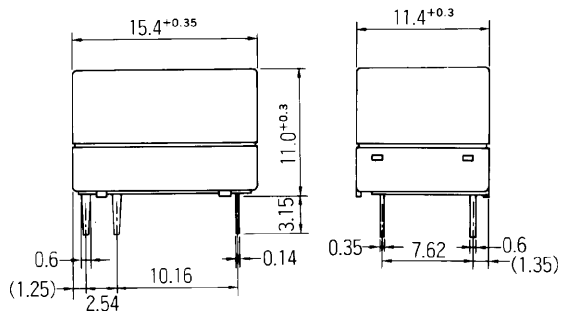

● Schematics (Bottom View)

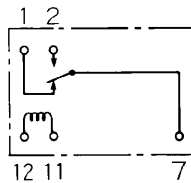

● PC board mounting hole layout (Bottom View)

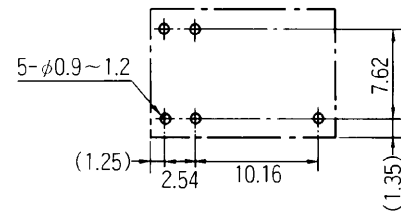

MZ (F)-K type (Plastic sealed type)

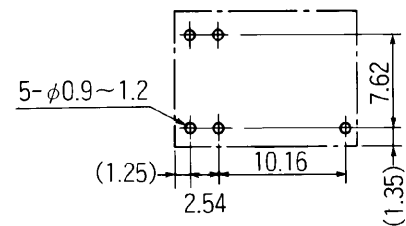
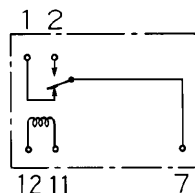
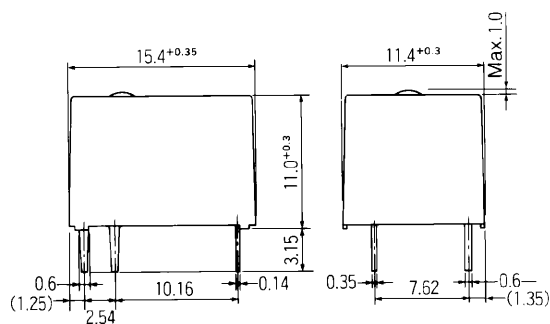

Unit: mm

Fujitsu Components International Headquarter Offices

Japan

Fujitsu Component Limited
Gotanda-Chuo Building
3-5, Higashigotanda 2-chome, Shinagawa-ku
Tokyo 141, Japan
Tel: (81-3) 5449-7010
Fax: (81-3) 5449-2626
Email: promothq@ft.ed.fujitsu.com
Web: www.fcl.fujitsu.com

North and South America

Fujitsu Components America, Inc.
250 E. Caribbean Drive
Sunnyvale, CA 94089 U.S.A.
Tel: (1-408) 745-4900
Fax: (1-408) 745-4970
Email: marcom@fcai.fujitsu.com
Web: www.fcai.fujitsu.com

Europe

Fujitsu Components Europe B.V.
Diamantlaan 25
2132 WV Hoofddorp
Netherlands
Tel: (31-23) 5560910
Fax: (31-23) 5560950
Email: info@fceu.fujitsu.com
Web: www.fceu.fujitsu.com

Asia Pacific

Fujitsu Components Asia Ltd.
102E Pasir Panjang Road
#04-01 Citilink Warehouse Complex
Singapore 118529
Tel: (65) 6375-8560
Fax: (65) 6273-3021
Email: fcal@fcal.fujitsu.com
www.fcal.fujitsu.com

© 2003 Fujitsu Components America, Inc. All company and product names are trademarks or registered trademarks of their respective owners. Rev. 02/12/2003