

Phase Control Thyristor Stud Types N0290SX120 to N0290SX160

The data sheet on the subsequent pages of this document is a scanned copy of existing data for this product.
(Rating Report 86TR10 Issue 1)

This data reflects the old part number for this product which is: N170PH02-15.
This part number must **NOT** be used for ordering purposes – please use the ordering particulars detailed below.

The limitations of this data are as follows:
Only SC outline drawing (W18) in datasheet
No reverse recovery information available
Device no longer available for grades 02 to 10 (200V to 1000V V_{RRM}/V_{DRM})

The following links will direct you to the appropriate outline drawings
[Outline W18](#) – 3/4" Ceramic stud
[Outline W25](#) – 3/4" Ceramic stud removed



Where any information on the product matrix page differs from that in the following data, the product matrix must be considered correct

An electronic data sheet for this product is presently in preparation.

For further information on this product, please contact your local ASM or distributor.

Alternatively, please contact Westcode as detailed below.

Ordering Particulars			
N0290	SX	◆◆	0
Fixed Type Code	SC – 3/4" Ceramic stud SD – 3/4" Ceramic stud removed	Voltage code $V_{RRM}/100$ 12-16	Fixed Code
Typical Order Code: N0290SD140, 3/4" Ceramic stud removed, 1400V V_{RRM}/V_{DRM}			

<p>IXYS Semiconductor GmbH Edisonstraße 15 D-68623 Lampertheim Tel: +49 6206 503-0 Fax: +49 6206 503-627 E-mail: marcom@ixys.de</p>	 <p style="font-size: small;">An  IXYS Company</p>	<p>Westcode Semiconductors Ltd Langley Park Way, Langley Park, Chippenham, Wiltshire, SN15 1GE. Tel: +44 (0)1249 444524 Fax: +44 (0)1249 659448 E-mail: WSL.sales@westcode.com</p>	
<p>IXYS Corporation 3540 Bassett Street Santa Clara CA 95054 USA Tel: +1 (408) 982 0700 Fax: +1 (408) 496 0670 E-mail: sales@ixys.net</p>	<p>www.westcode.com</p> <p>www.ixys.com</p>	<p>Westcode Semiconductors Inc 3270 Cherry Avenue Long Beach CA 90807 USA Tel: +1 (562) 595 6971 Fax: +1 (562) 595 8182 E-mail: WSI.sales@westcode.com</p>	
<p>The information contained herein is confidential and is protected by Copyright. The information may not be used or disclosed except with the written permission of and in the manner permitted by the proprietors Westcode Semiconductors Ltd.</p> <p>In the interest of product improvement, Westcode reserves the right to change specifications at any time without prior notice.</p> <p>Devices with a suffix code (2-letter, 3-letter or letter/digit/letter combination) added to their generic code are not necessarily subject to the conditions and limits contained in this report.</p>			<p>© Westcode Semiconductors Ltd.</p>

QUALITY EVALUATION LABORATORY

Rating Report: 86TR10
Origin:

Date : 3rd July, 1986
Pages : 12

Thyristor Type N170PH02-H15

Written: *M.W. Dunlop*

Checked: *M.W. Dunlop*

Approved: *[Signature]*

The thyristor consists of a diffused silicon slice of 24 mm diameter mounted under spring pressure in a stud base, top hat housing with flexible lead. This Report supersedes Rating Report No. 79TR26 (Issue 2)

Ratings

Voltage Grades	:	H02-H15
V_{DSM}	:	200-1500V
V_{RSM}	:	300-1600V
V_{DRM}, V_{RRM}	:	200-1500V
I_T (AV) : Single phase : 50 Hz, 180° sinewave $T_{CASE} = 85^\circ C$:	196A
I_T (rms) max.	:	355A
I_T d.c. max.	:	355A
$I_{TSM} : t = 10ms$ half sinewave; T_J (initial) = 125°C: $V_{RM} = 0.6V_{RRM}$ (MAX)	:	4200A
$I_{TSM} : t = 10ms$ half sinewave; T_J (initial) = 125°C: $V_{RM} \leq 10V$:	4620A
$I^2t : t = 10 ms$; T_J (initial) = 125°C : $V_{RM} = 0.6V_{RRM}$ (MAX)	:	$88.2 \times 10^3 A^2S$
$I^2t : t = 10 ms$; T_J (initial) = 125°C : $V_{RM} \leq 10V$:	$106.7 \times 10^3 A^2S$
$I^2t : t = 3 ms$; T_J (initial) = 125°C : $V_{RM} \leq 10V$:	$79.4 \times 10^3 A^2S$
di/dt : (Repetitive) $T_J = 125^\circ C$ Gate: 20V $20 \mu s$ Rise time 1μS	:	500A/μS
I_{FGM} : Anode positive with respect to cathode	:	20A
V_{FGM} : " " " " " "	:	18V
V_{RGM} :	:	5V
P_G (AV) :	:	2W
P_{GM} :	:	100W
V_{GD} :	:	0.25V
T_C operating range	:	-40 to 125°C
T_{stg} Non-operating	:	-40 to 150°C

Characteristics

(maximum values unless stated otherwise)

$I_{GT} : T_J = 25^{\circ}C$)					:	150mA
$I_H : T_J = 25^{\circ}C$)	$V_A = 6V$;	$I_A = 1A$:	600mA
$V_{GT} : T_J = 25^{\circ}C$)					:	3V
$V_O : T_J = 125^{\circ}C$:	1.08V
$r_T : T_J = 125^{\circ}C$:	1.3mohms
$V_{TM} : I_{TM} = 616A$		$T_{VJ} = 125^{\circ}C$:	1.88V
$R_{th} (J/C)$:	0.12°C/W
dV/dt	:	Linear ramp to $0.8V_{DRM(max)}$,	$T_J = 125^{\circ}C$:	Gate O/C; repetitive :	$200V/\mu S^*$
$I_{DRM} : T_J = 125^{\circ}C$		$V_{DM} = V_{DRM(max)}$:	20mA
$I_{RRM} : T_J = 125^{\circ}C$		$V_{RM} = V_{RRM(max)}$:	20mA
$Q_{RR} : I_{TM} =$		dI/dt		$A/\mu S$,		50% chord value
		$V_{RM} :$		$T_{VJ} = 125^{\circ}C$:	
$tq : I_{TM}$		dI/dt		$A/\mu S$;	$T_J = 125^{\circ}C$	$V_{RM} = 50V$
		$dV/dt = 200V/\mu S$		to $0.8V_{DRM}$:	
		When specified, $20V/\mu S$		to $0.8V_{DRM}$:	Typical
Outline drawing						:	101A225
$R_{th} (C-H.S.)$:	0.04°C/W
Mounting torque						:	2.5 - 2.77Kg.m
Outline (JEDEC NO.)						:	

*Repetitive dv/dt

Higher dv/dt selections are available up to 1000V/uS on request.

CONTENTS

	<u>Page</u>
Ratings	1
Characteristics	2
Contents	3
Voltage Ratings	4
Dissipation and Heatsink Temperature vs Mean Current	5, 6
Limit On-state Characteristics	7
Transient Thermal Impedance Characteristic	8
Gate Characteristics and Gate Trigger Limits	9, 10
Surge Current and I^2t vs Duration of Surge	11
Outline Drawing	12

Changes to 79TR26 (Issue 2)

- p1: V_{DWM} , V_{RWM} deleted
 I_{FGM} increased to 20A
 T_{HS} operating range MIN decreased to -40°C
- p2: $I_L (=200\text{mA})$ changed to I_H at 6V, $1A = 600\text{mA}$
Note 1 deleted; replaced by dV/dt note.
- p7: $I_T - V_T$, Z_{th-t} now on separate pages
- New p9: $V_G - I_G$: I_{FGM} increased to 20A
- New p10: $I_{GT} - V_{GT}$: axes interchanged

Voltage Ratings

Voltage Grade 'H'	V_{DSM} V_{DRM} V_{RRM} V	V_{RSM} V	V_D V_R DC
02	200	300	140
03	300	400	210
04	400	500	260
06	600	700	420
08	800	900	560
10	1000	1100	700
12	1200	1300	810
14	1400	1500	930
15	1500	1600	980

Extension of Voltage Grades

This report is applicable to other and higher voltage grades when supply has been agreed by Sales/Production.

SINE WAVE
= conduction angle (degrees)

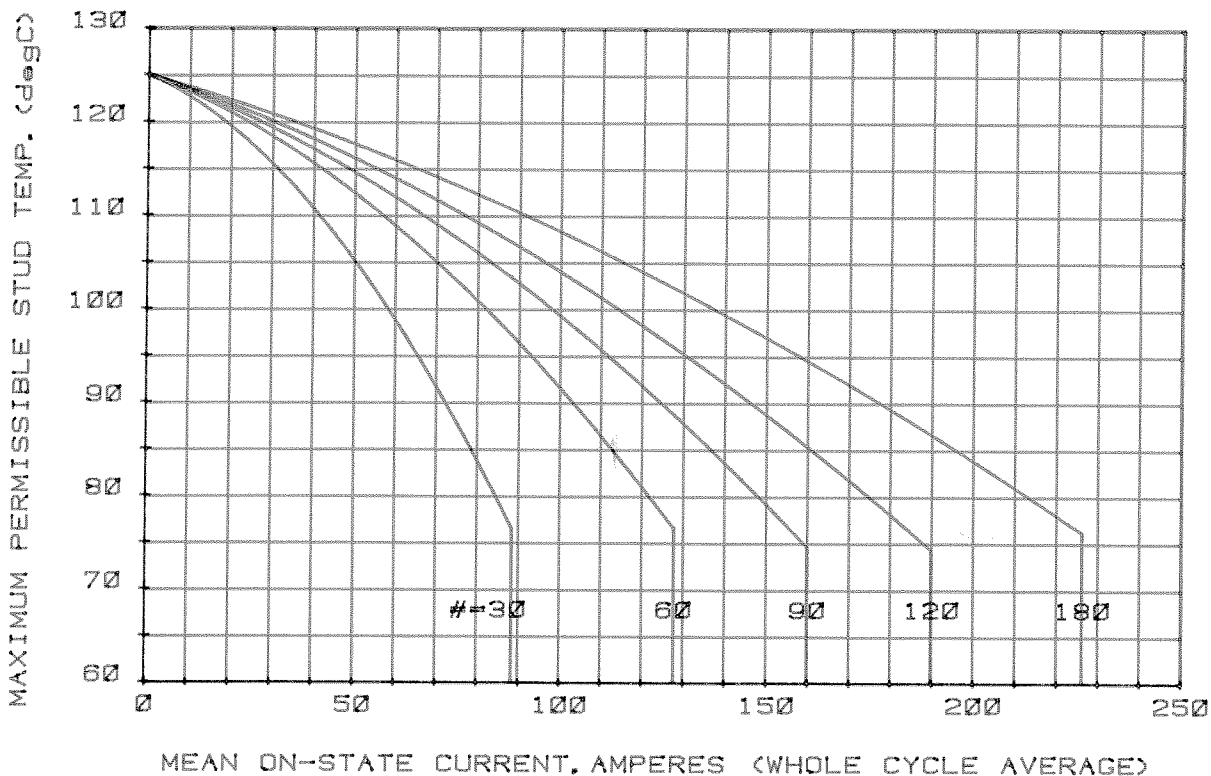
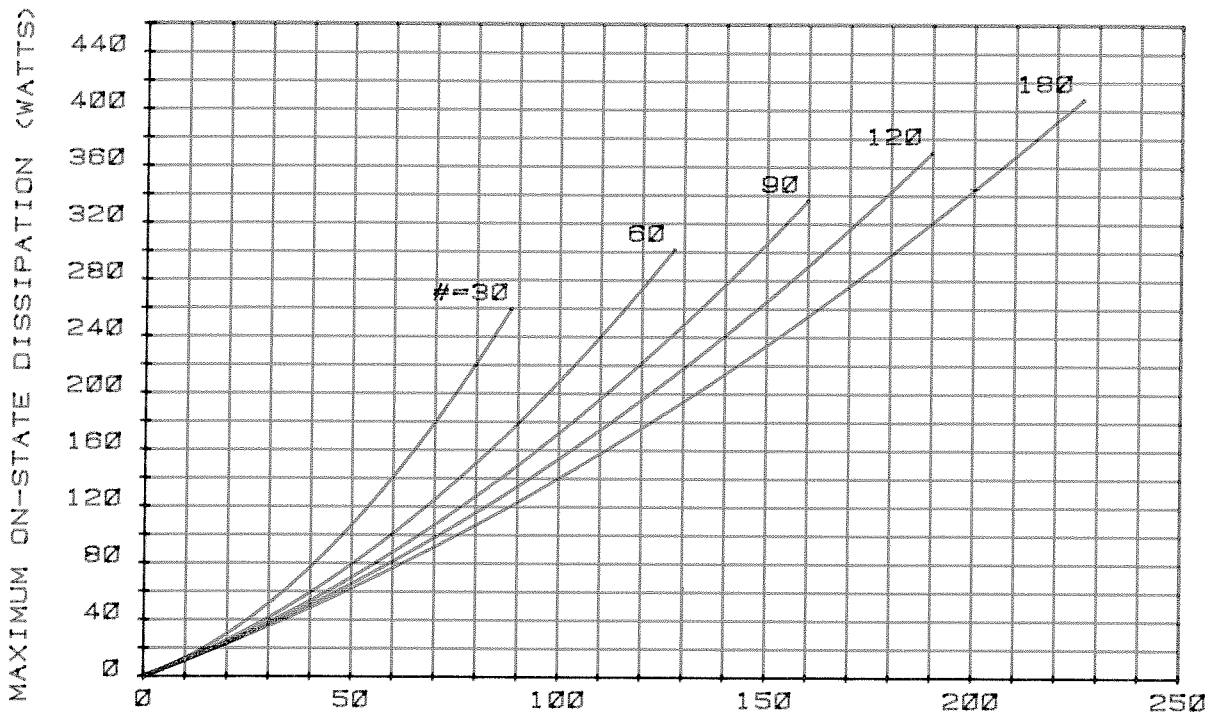

SQUARE WAVE

= conduction angle (degrees)

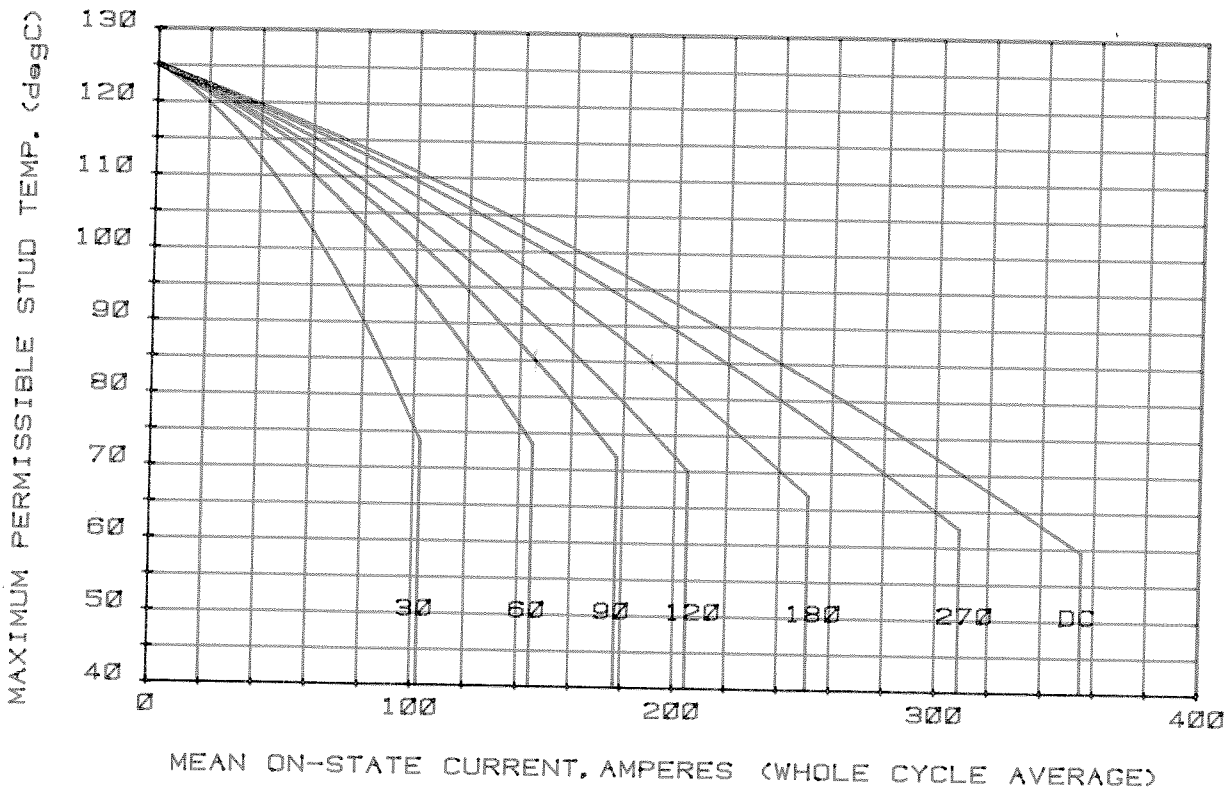
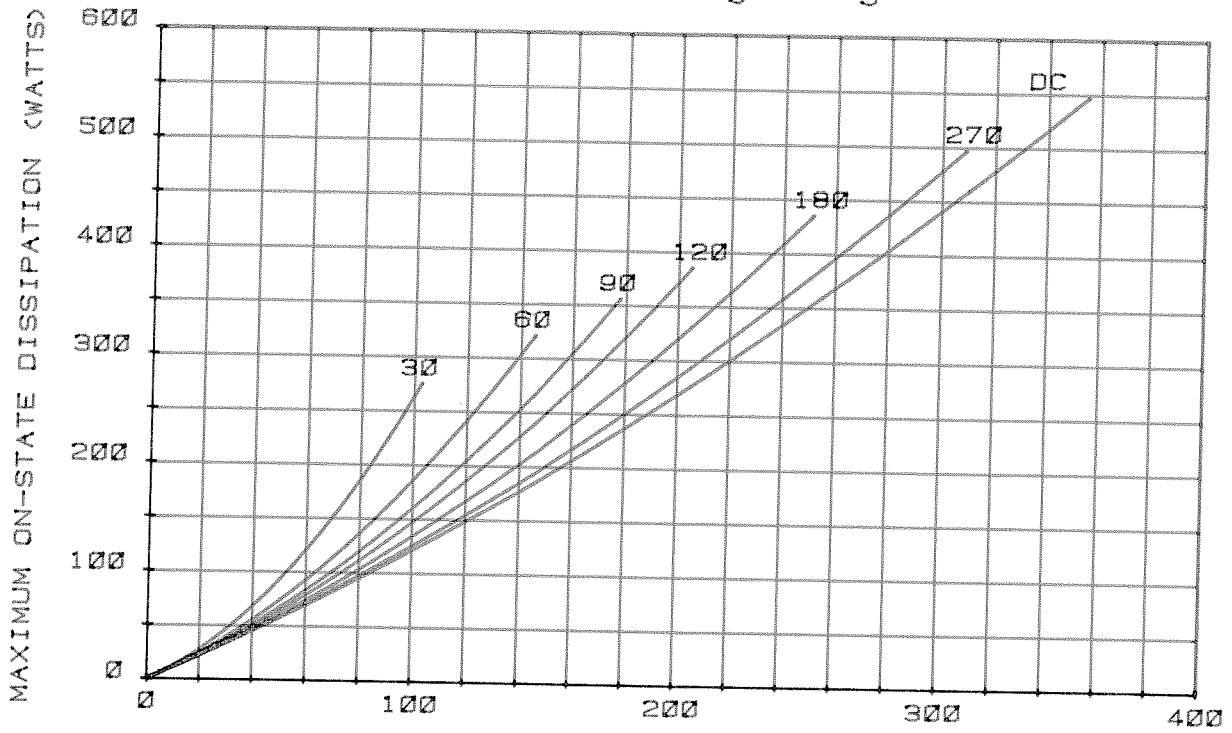

ON-STATE CHARACTERISTIC OF LIMIT DEVICE

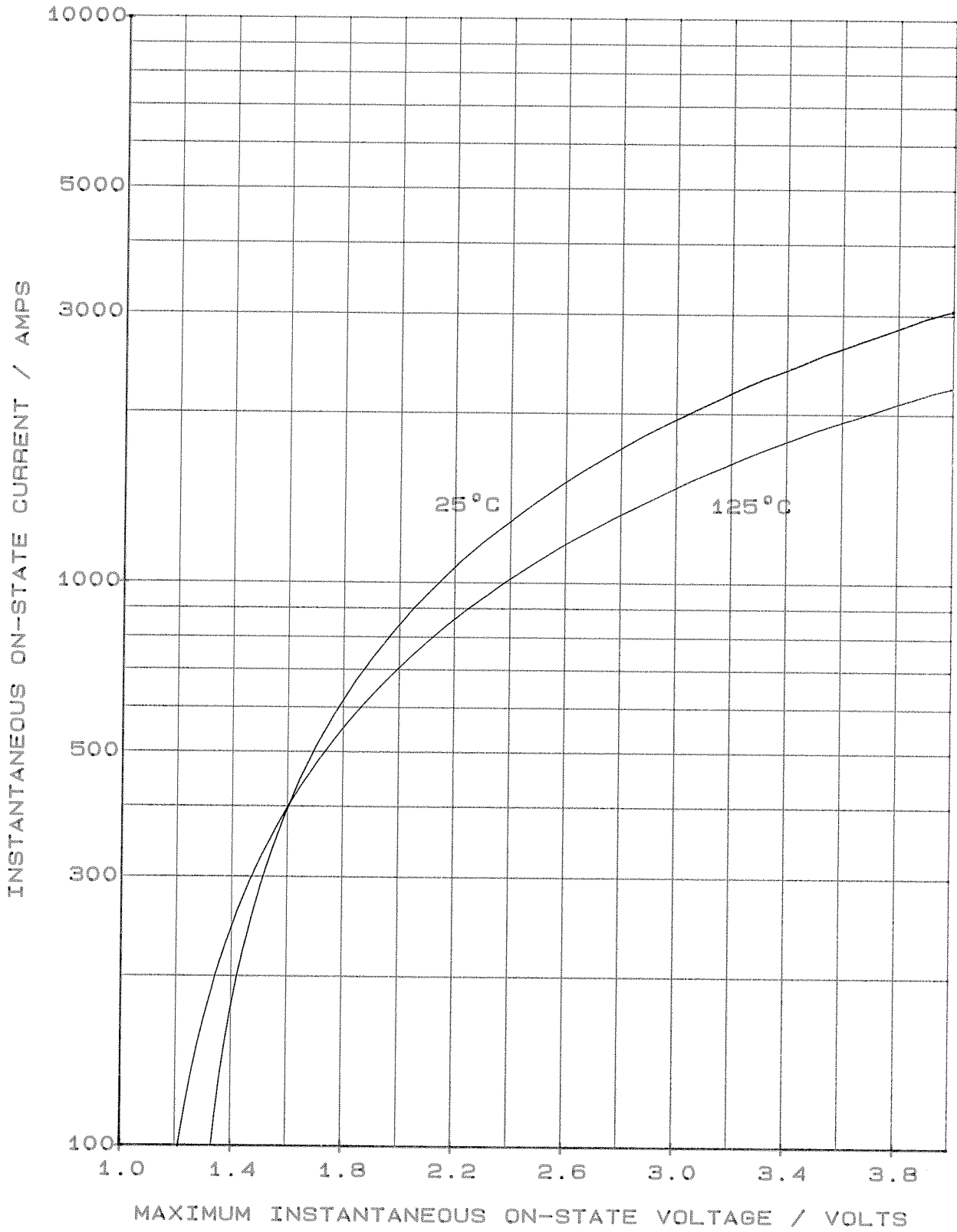

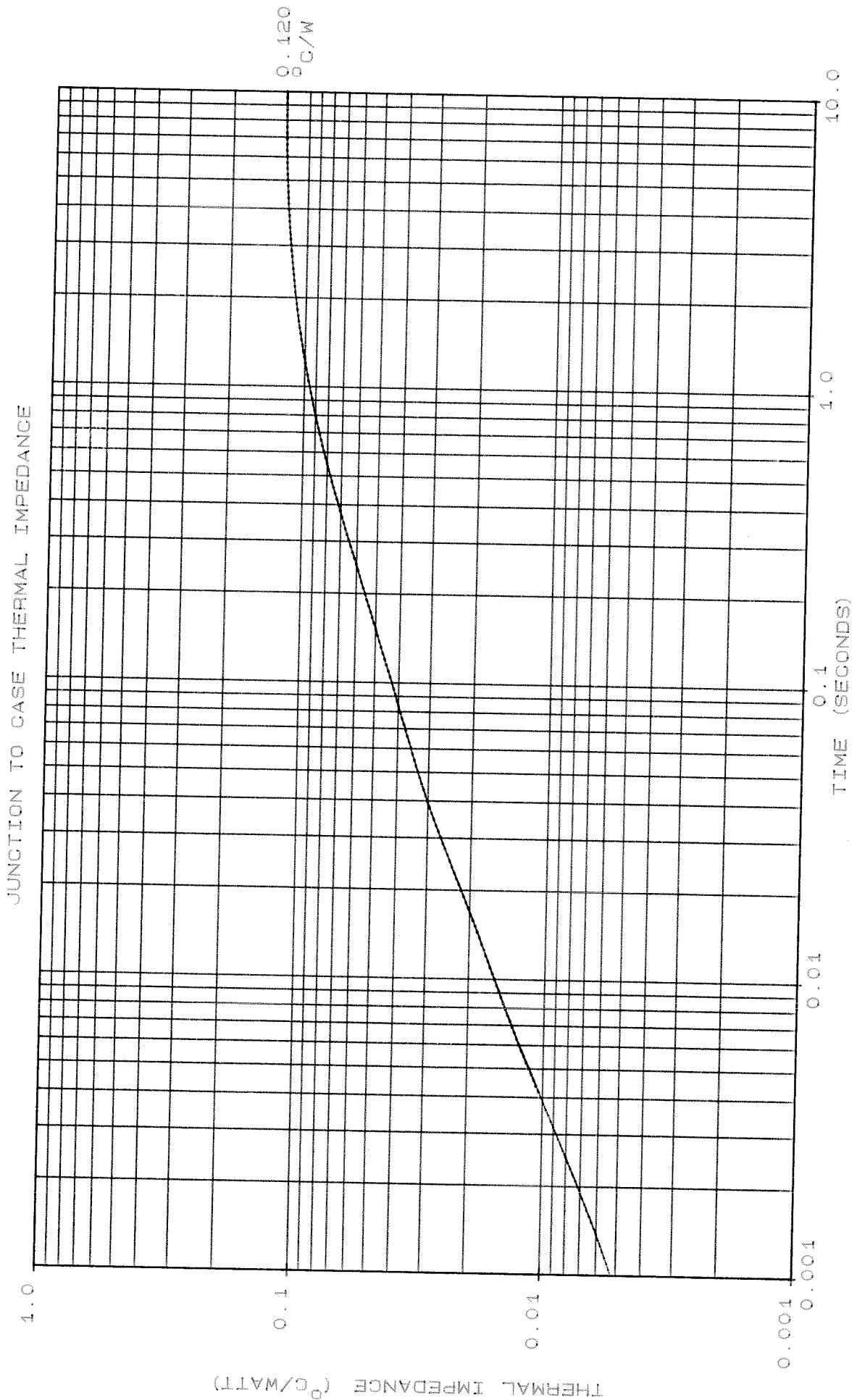

GATE CHARACTERISTICS AT 25°C JUNCTION TEMPERATURE

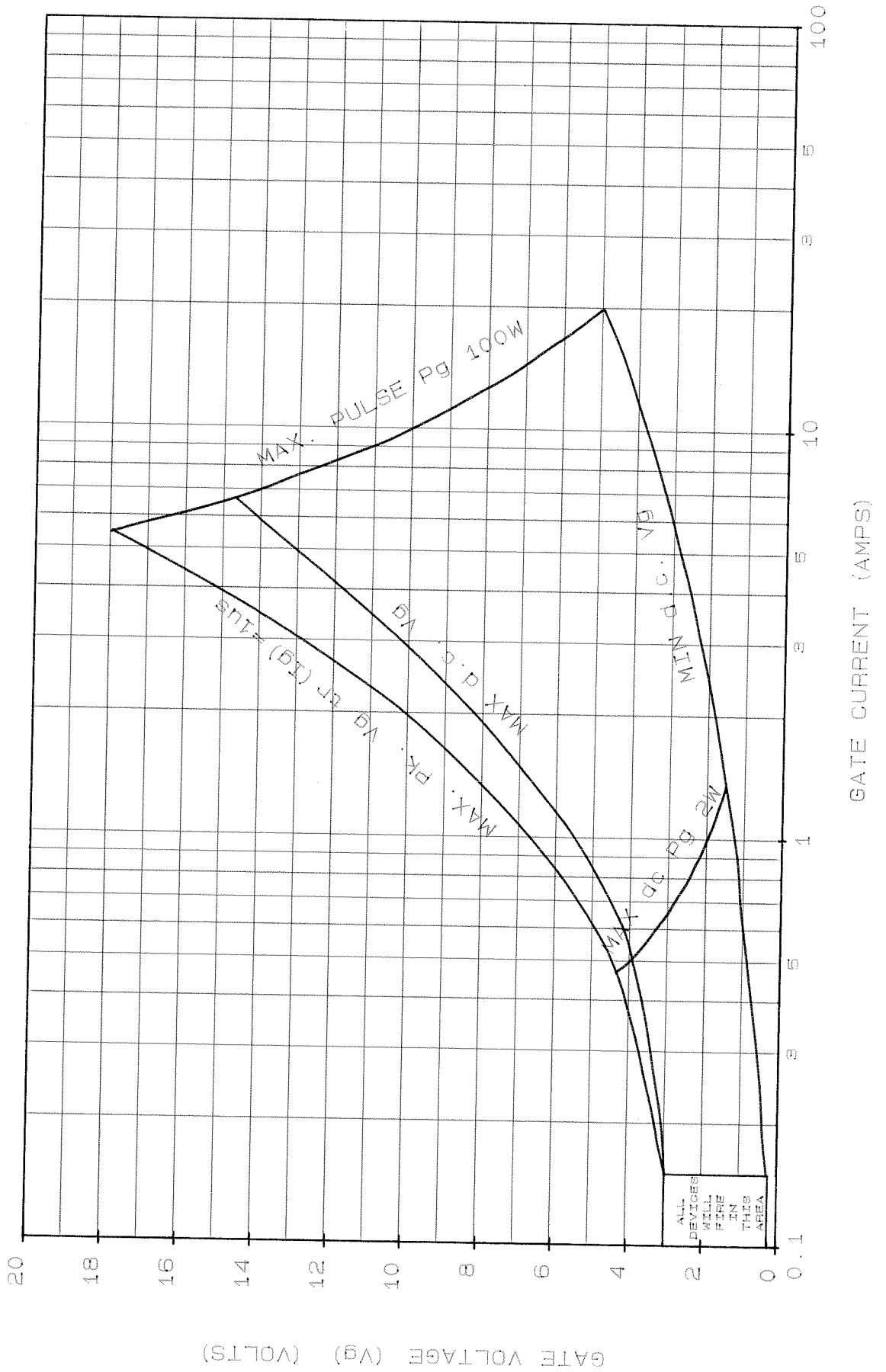

GATE TRIGGERING CHARACTERISTICS
(TRIGGER POINTS OF ALL THYRISTORS LIE IN THE AREAS SHOWN)

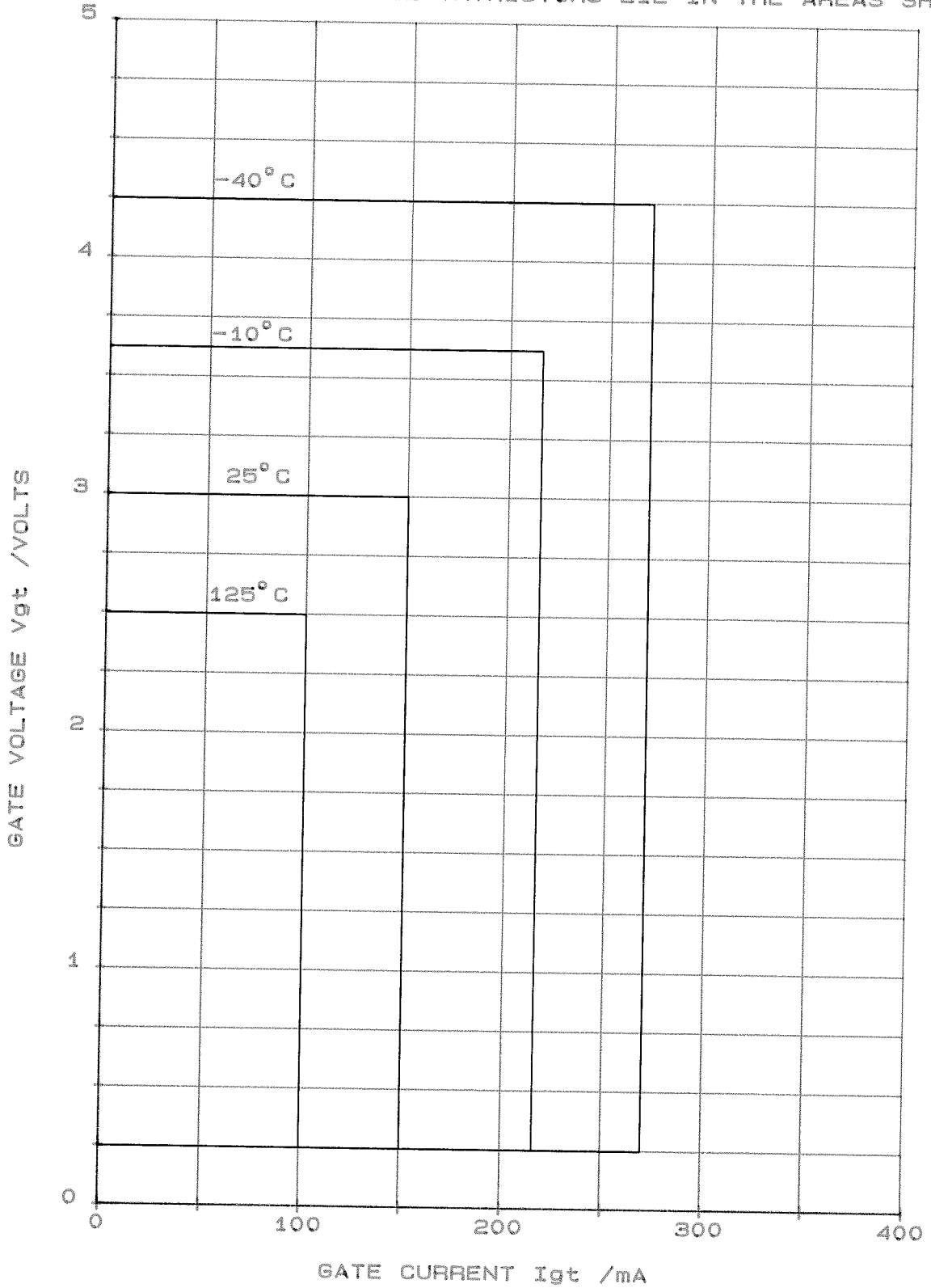

MAXIMUM NON REPETITIVE SURGE CURRENT AT INITIAL JUNCTION TEMPERATURE 125°C
 (GATE MAY TEMPORARILY LOSE CONTROL OF CONDUCTION ANGLE)

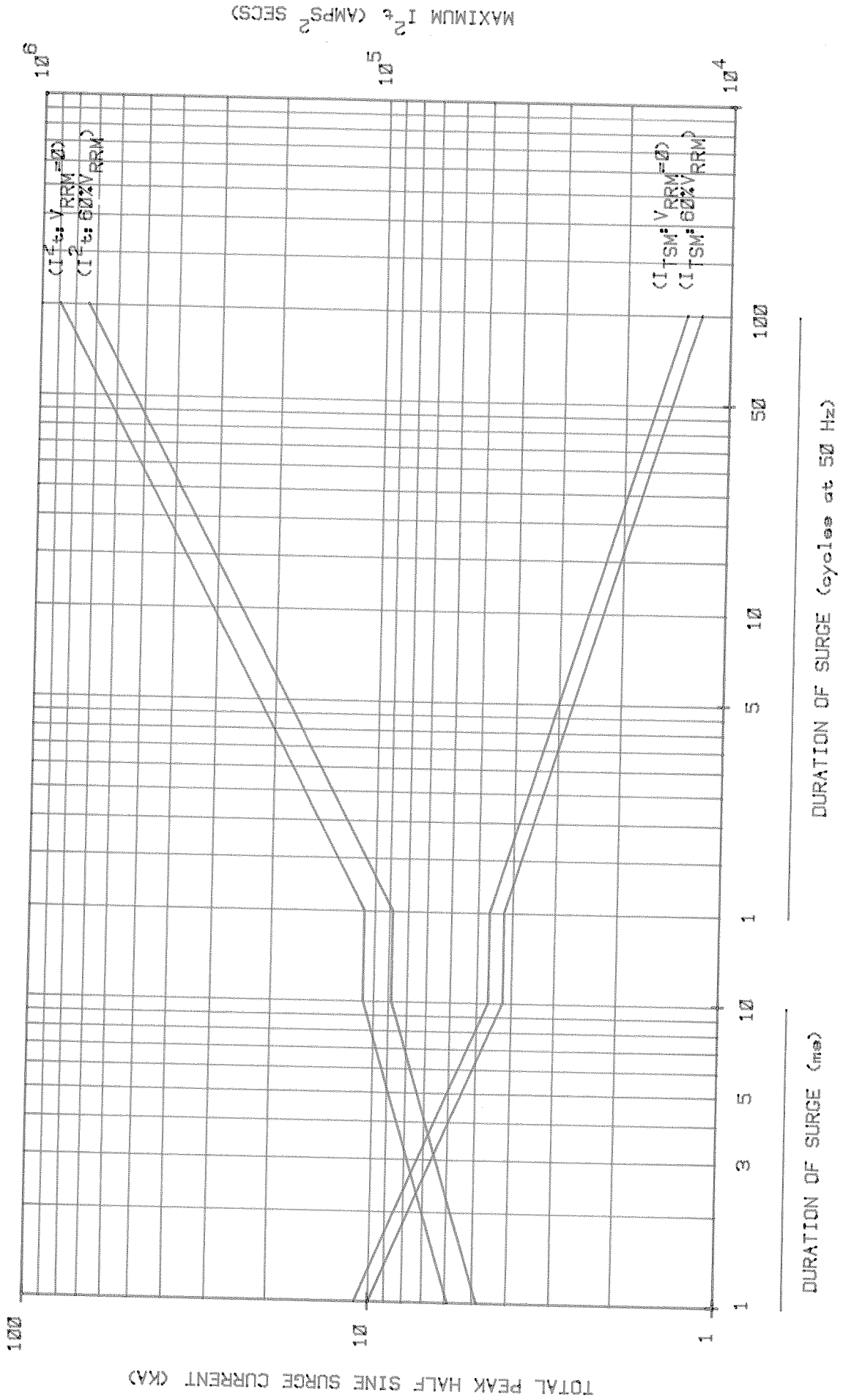

TOTAL PEAK HALF SINE SURGE CURRENT (KA)

DURATION OF SURGE (ms)

DURATION OF SURGE (cycles at 50 Hz)

SCALE	1/1
DRN	1/1
CHKD	1/1
APPD	
S	NI

INTERNATIONAL OUTLINE No.
 WEIGHT. 280 GRAMS APPX.
 FINISH. BRIGHT NICKEL PLATE.
 DEVICE MARKING INCLUDES MONOGRAM, TYPE No., SPEC.
 No. AND POLARITY SYMBOL.
 DEVICE MOUNTING: MOUNTING TORQUE
 27-24.5 Nm (2.77-2.5 kgf-m).
 THREAD MUST NOT BE LUBRICATED.

TYPE NUMBER	
N170P	P200P
N195P	P202P
N275P	P204P
	P205P
	P214P
	P215P
	P270P

NOTES.

G.A. DRG. No. 103A162

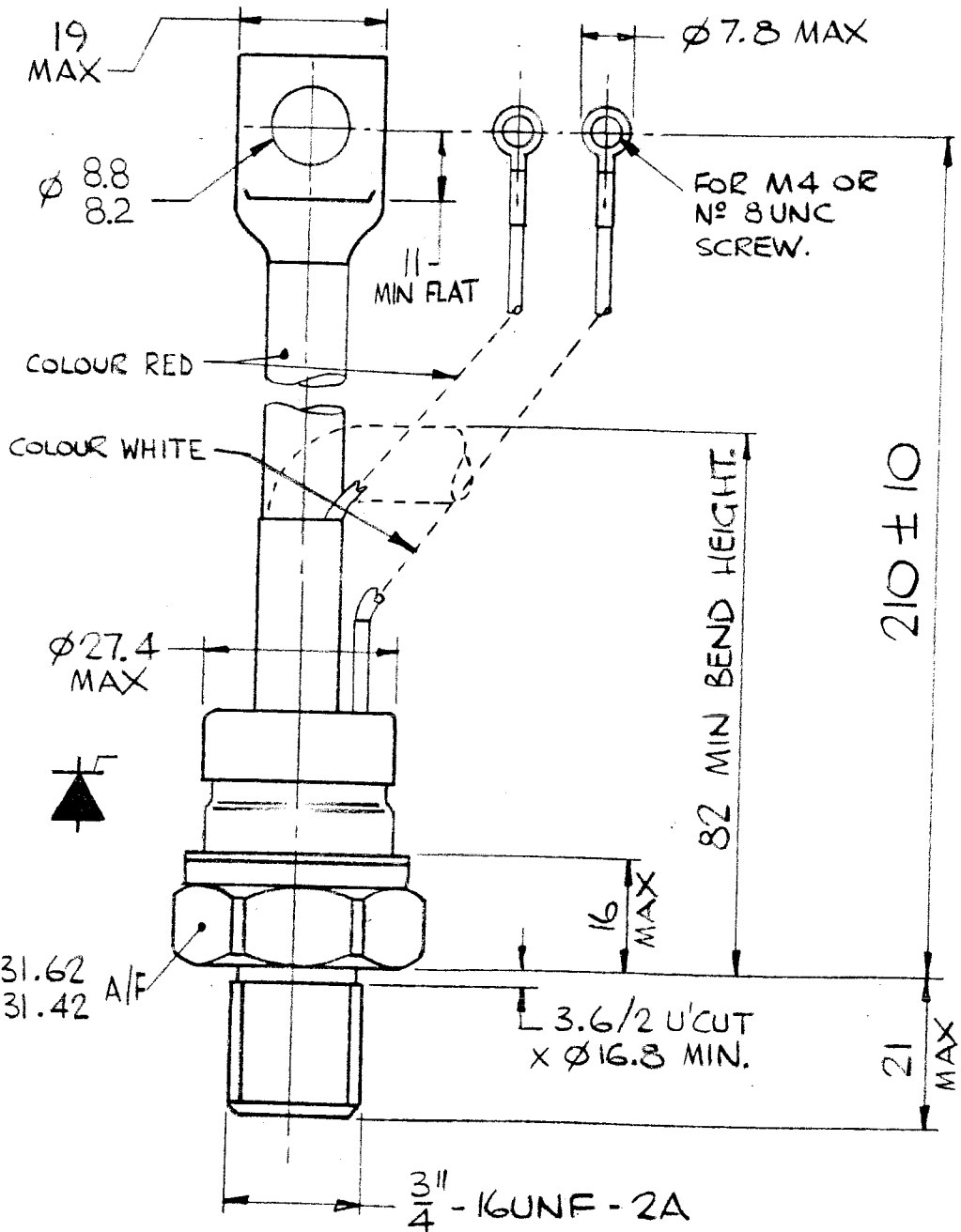

THE INFORMATION CONTAINED IN THIS DRAWING IS SUPPLIED IN CONFIDENCE AND IS PROTECTED BY COPYRIGHT. THE INFORMATION MAY NOT BE DISCLOSED EXCEPT WITH THE WRITTEN PERMISSION OF AND IN MANNER PERMITTED BY THE PROPRIETORS, WESTINGHOUSE BRAKE AND SIGNAL CO. LTD.

WESTINGHOUSE BRAKE AND SIGNAL CO. LTD.
 CHIPPENHAM, WILTSHIRE, SN15 1JD, ENGLAND.



WESTCODE®
 SEMICONDUCTORS

THIRD ANGLE PROJECTION

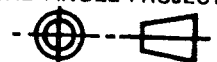

DIMNS. IN MILLIMETRES

DRG. No.

101A225

ISS	REVISIONS
1	19.9.78
2	17.11.78 M670 TYPE N° ADDED
3	ϕ 8.8/8.2 HOLE WAS 10.7/10.2
4	17.12.79 M817 19 WAS 21.4
5	27.11.84 M1218 FIN WAS ET.
6	10.10.88 RED & WHITE WERE VIOLET & ORANGE