



InfoVision Optoelectronics (Kunshan) Co.,LTD.

	Document Name	N1251 R0 Module Product Information			Page 2 of 28	
	Document No.	E-M125NWN1-R0	Made/Revised Date	2012/08/03	Ver.	00

CONTENTS

1.0	GENERAL DESCRIPTIONS	3
2.0	ABSOLUTE MAXIMUM RATINGS.....	5
3.0	PIXEL FORMAT IMAGE.....	7
4.0	OPTICAL CHARACTERISTICS	8
5.0	BACKLIGHT CHARACTERISTICS.....	11
6.0	ELECTRICAL CHARACTERISTICS	12
7.0	INTERFACE TIMINGS	17
8.0	POWER CONSUMPTION.....	18
9.0	POWER ON/OFF SEQUENCE.....	19
10.0	MECHANICAL CHARACTERISTICS	20
11.0	PACKAGE SPECIFICATION	24
12.0	LOT MARK.....	24
13.0	GENERAL PRECAUTION.....	25
14.0	EDID DATA STRUCTURE	27

InfoVision Optoelectronics (Kunshan) Co.,LTD.

	Document Name	N1251 R0 Module Product Information			Page 3 of 28	
	Document No.	E-M125NWN1-R0	Made/Revised Date	2012/08/03	Ver.	00

1.0 General Descriptions

1.1 Introduction

The M125NWN1 R0 is a color active matrix thin film transistor (TFT) liquid crystal display (LCD) that uses amorphous silicon TFT as a switching device. It is composed of a TFT LCD panel, a timing controller, voltage reference, common voltage, column driver, and row driver circuit. This TFT LCD has a 12.5-inch diagonally measured active display area with HD resolution (1,366 horizontal by 768 vertical pixel array).

1.2 Features

- 12.5" TFT-LCD Panel
- LED Backlight System
- Supported HD Resolution (1,366x768 pixels)
- Compatible With ROHS Standard
- Supported eDP1.2 Electrical Interface

1.3 Product Summary

Items	Specifications	Unit	Remark
Screen Diagonal	12.5"	inch	-
Active Area	276.615 (H) x 155.52(V)	mm	-
Pixels(H x V)	1,366 (RGB)x 768	-	-
Pixel Pitch	0.2025 (H) × 0.2025 (V)	mm	-
Pixel Arrangement	R.G.B. Vertical Stripe	-	-
Display Mode	Normally White (TN)	-	-
White Luminance	200(Typ) 170 (Min)	cd / m ²	5 Points Average
Contrast Ratio	500 (Typ) 400 (Min)	-	-
Response Time	(8) (Typ)	ms	-
Input Voltage	3.3	V	-
Power Consumption	(3.3)(Max)	Watt	Black Pattern
Module Weight	(250)(Max)	g	-
Outline Dimension(H x V x D)	290.5(Typ.)x181.4(Typ.)x3.0(Max)	mm	-
Electrical Interface (Logic)	eDP1.2	-	-
Support Color	262 K	-	-
NTSC	(45)(Typ.)	%	-
Optimum Viewing Direction	6 o'clock	-	-
Surface Treatment	Anti-Glare +HC(3H)	-	-

	Document Name	N1251 R0 Module Product Information			Page 4 of 28	
	Document No.	E-M125NWN1-R0	Made/Revised Date	2012/08/03	Ver.	00

1.4 Functional Block Diagram

Figure 1 shows the functional block diagram of the LCD module.

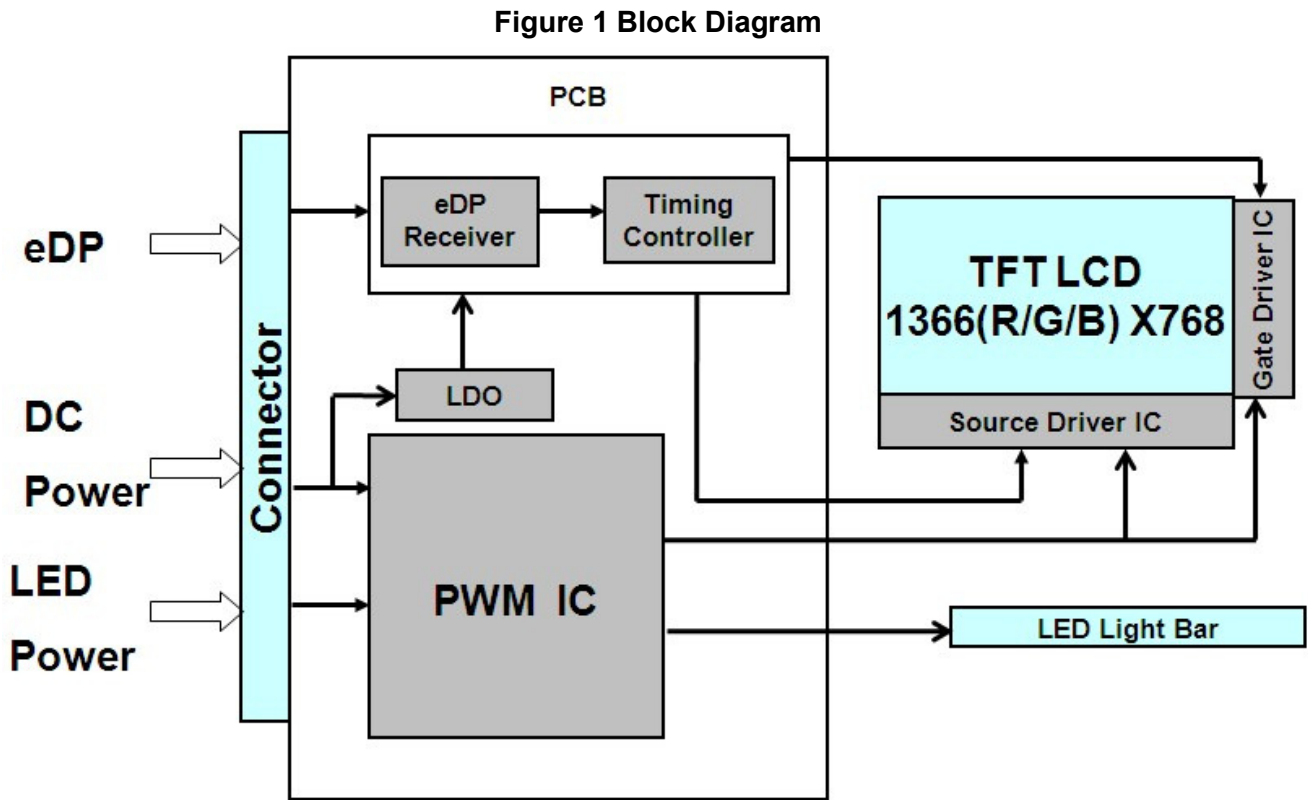

InfoVision Optoelectronics (Kunshan) Co.,LTD.

	Document Name	N1251 R0 Module Product Information			Page 5 of 28	
	Document No.	E-M125NWN1-R0	Made/Revised Date	2012/08/03	Ver.	00

2.0 Absolute Maximum Ratings

Table 1 Electrical Absolute Rating

Item	Symbol	Min.	Max.	Unit	Note
Logic Supply Voltage	V_{DD}	-0.3	4.0	V	(1),(2)
Supply V_{LED} Voltage	V_{LED}	6	21	V	
LED Reverse Voltage	V_R	-	(5)	V	
LED Forward Current	I_F	-	(30)	mA	

Note (1) Permanent damage may occur to the LCD module if beyond this specification. Functional operation should be restricted to the conditions described under normal operating conditions.

(2) Operating temperature 25 °C , humidity 55%.

Table 2 Absolute Ratings of Environment

Item	Symbol	Min.	Max.	Unit	Conditions
Operating Temperature	TOP	0	50	°C	(1),(2),(3)
Operating Humidity	HOP	10	(95)	%RH	
Storage Temperature	TST	-20	60	°C	
Storage Humidity	HST	10	(95)	%RH	
Vibration(non-operating)	Vnop	-	1.5	G	(4)
Shock(non-operating)	Snop	-	210G	G	(5)

Note (1) Maximum Wet-Bulb temperature should be 39 °C . No condensation of water.

(2) When you apply the LCD module for OA system. Please make sure to keep the temperature of LCD module is less than 60 °C .

(3) Storage /Operating temperature:

InfoVision Optoelectronics (Kunshan) Co.,LTD.



	Document Name	N1251 R0 Module Product Information			Page 6 of 28	
	Document No.	E-M125NWN1-R0	Made/Revised Date	2012/08/03	Ver.	00

Figure 2 Absolute Ratings of Environment of the LCD Module

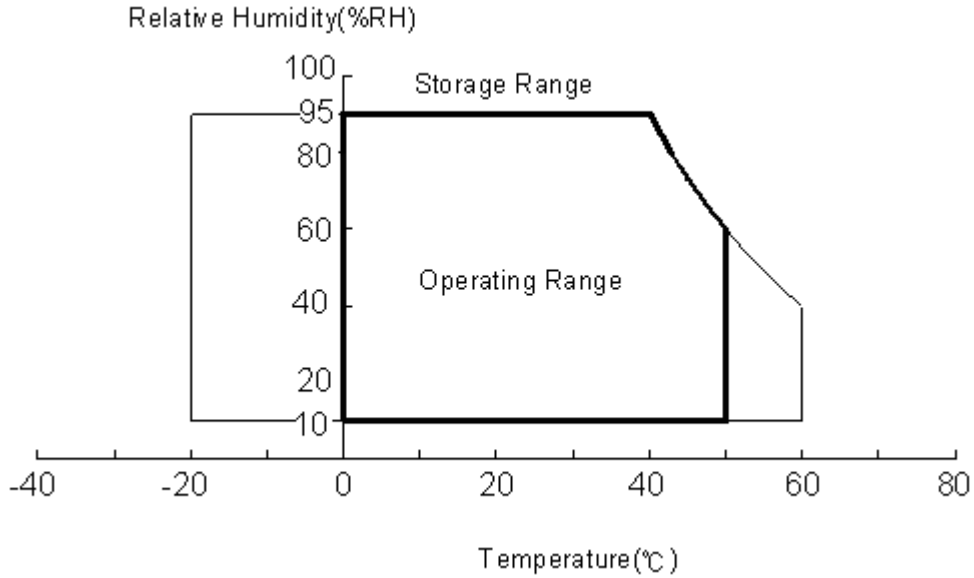

(4) 10-200Hz, random vibration, 30min for X, Y, Z axis.

(5) 3ms, half sine wave, one time for $\pm X$, $\pm Y$, $\pm Z$ axis.

	Document Name	N1251 R0 Module Product Information			Page 7 of 28	
	Document No.	E-M125NWN1-R0	Made/Revised Date	2012/08/03	Ver.	00

3.0 Pixel Format Image

Figure 3 shows the relationship of the input signals and LCD pixel format image.

Figure 3 Pixel Format

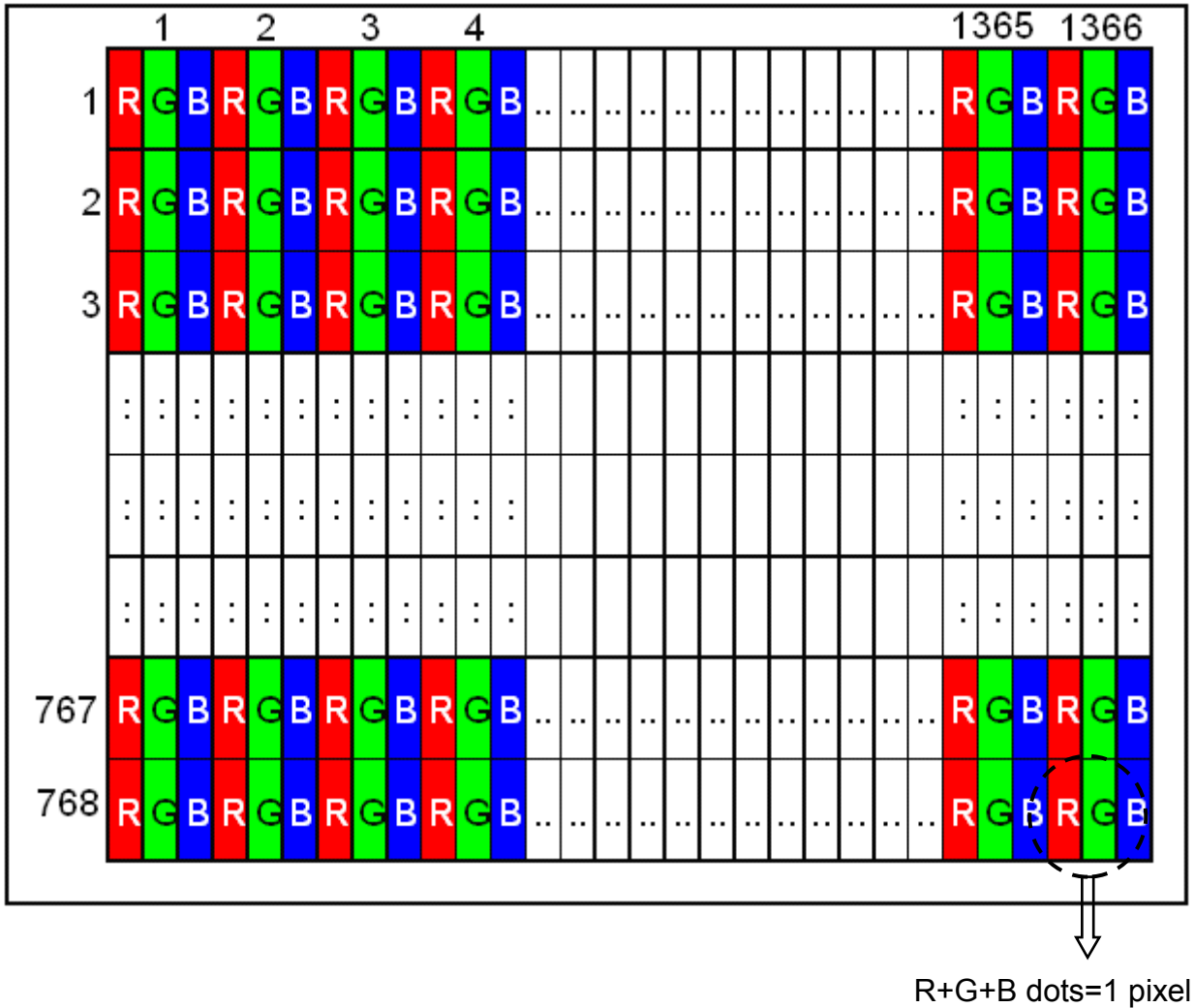

InfoVision Optoelectronics (Kunshan) Co.,LTD.

	Document Name	N1251 R0 Module Product Information			Page 8 of 28	
	Document No.	E-M125NWN1-R0	Made/Revised Date	2012/08/03	Ver.	00

4.0 Optical Characteristics

The optical characteristics are measured under stable conditions as following notes.

Table 3 Optical Characteristics

Item	Conditions		Min.	Typ.	Max.	Unit	Note		
Viewing Angle (CR>10)	Horizontal	θ_L	-	45	-	degree	(1),(2),(3)		
		θ_R	-	45	-				
	Vertical	θ_T	-	15	-				
		θ_B	-	35	-				
Contrast Ratio	Center		(400)	(500)	-	-	(1),(2),(4)		
Response Time	Rising	T_R	-	(3)	-	ms	(1),(2),(5)		
	Falling	T_F	-	(5)	-	ms			
	Rising + Falling		-	(8)	16	ms			
Color Chromaticity (CIE1931)	Red	x	Typ. -(0.03)	TBD	Typ. +(0.03)	-	(1),(2)		
	Red	y		TBD		-			
	Green	x		TBD		-			
	Green	y		TBD		-			
	Blue	x		TBD		-			
	Blue	y		TBD		-			
	White	x		(0.288)		0.313		(0.338)	-
	White	y		(0.304)		0.329		(0.354)	-
White Luminance	-		170	200	-	cd/m ²	(1),(2),(6)		
Luminance Uniformity	5Points		80.0	-	-	%	(1),(2),(7)		
	13Points		60.0	-	-				

Note (1) Measurement Setup:

The LCD module should be stabilized at given temperature(25℃) for 15 minutes to avoid abrupt temperature change during measuring. In order to stabilize the luminance, the measurement should be executed after lighting backlight for 15 minutes in a windless room.

	Document Name	N1251 R0 Module Product Information			Page 9 of 28	
	Document No.	E-M125NWN1-R0	Made/Revised Date	2012/08/03	Ver.	00

Figure 4 Measurement Setup



Note (2) The LED input parameter setting as:

V_LED: 12V ($\pm 0.1\text{V}$)

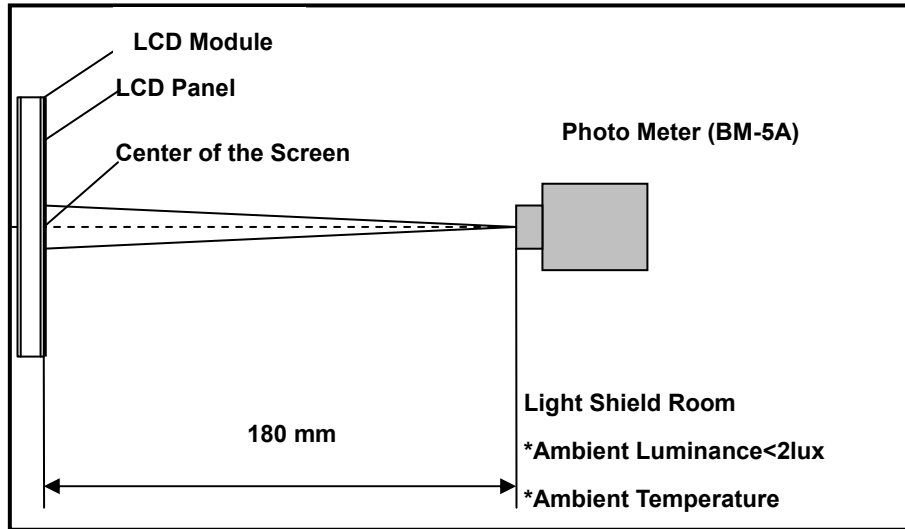
PWM_LED: Duty 100 %

Note (3) Definition of Viewing Angle

Figure 5 Definition of Viewing Angle

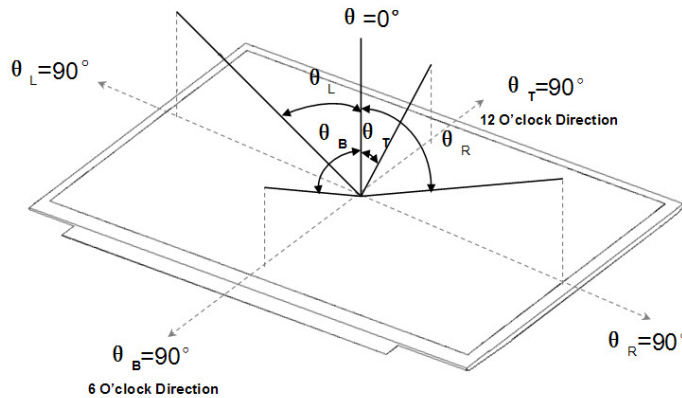

Note (4) Definition Of Contrast Ratio (CR)

The contrast ratio can be calculated by the following expression

$$\text{Contrast Ratio (CR)} = L_{63} / L_0$$

L63: Luminance of gray level 63, L0: Luminance of gray level 0

Note (5) Definition Of Response Time (T_R , T_F)

	Document Name	N1251 R0 Module Product Information			Page 10 of 28	
	Document No.	E-M125NWN1-R0	Made/Revised Date	2012/08/03	Ver.	00

Figure 6 Definition of Response Time



Note (6) Definition Of Luminance White

Measure the luminance of gray level 63 at center point (Ref: Active area)

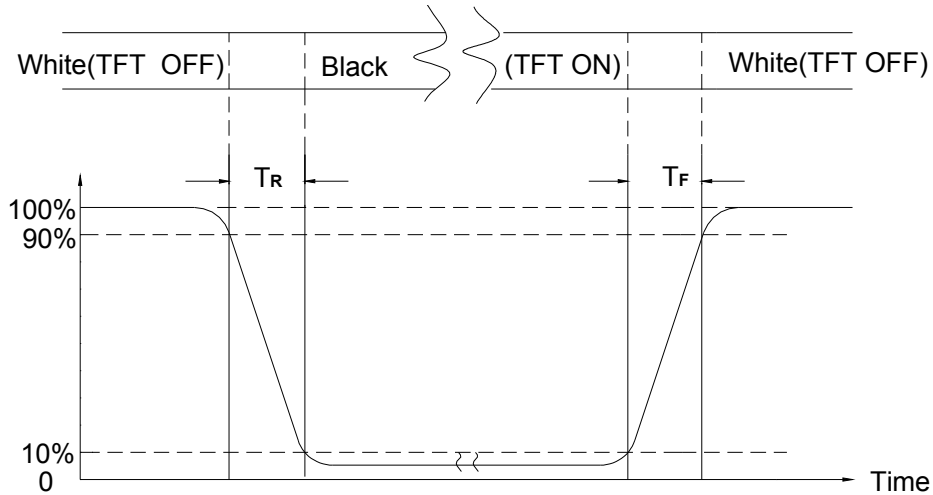
Display Luminance=(L1+L2+L3+L4+L5) / 5

H-Active area length V-Active area width L-Luminance

Figure 7 Measurement Locations of 5 Points

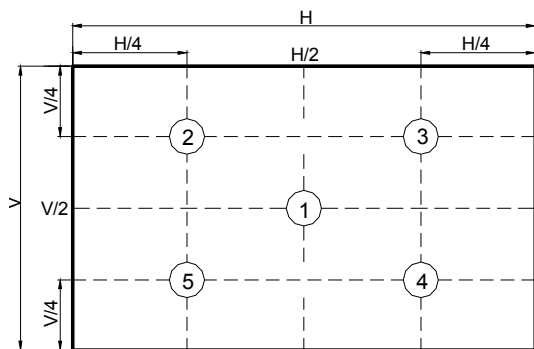
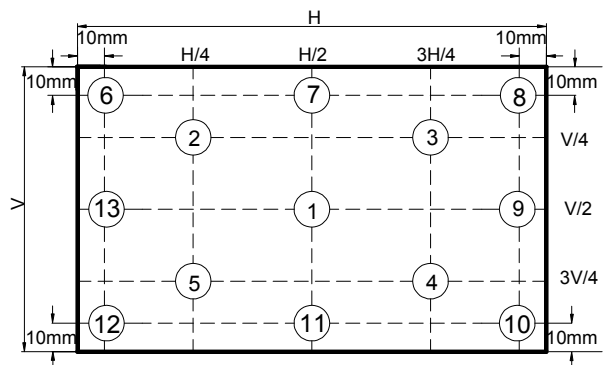

Figure 8 Measurement Locations of 13 Points



Note (7) Definition Of Luminance Uniformity (Ref: Active Area)

Measure the luminance of gray level 63 at 5points and 13 points.

$$UNF(5\text{ pts}) = \frac{\text{Min}(L1, L2, \Lambda L5)}{\text{Max}(L1, L2, \Lambda L5)} \% \quad UNF(13\text{pts}) = \frac{\text{Min}(L1, L2, \Lambda L13)}{\text{Max}(L1, L2, \Lambda L13)} \%$$

InfoVision Optoelectronics (Kunshan) Co.,LTD.

	Document Name	N1251 R0 Module Product Information			Page 11 of 28	
	Document No.	E-M125NWN1-R0	Made/Revised Date	2012/08/03	Ver.	00

5.0 Backlight Characteristics

5.1 Parameter Guideline Of LED Backlight

Table 4 Parameter Guideline for LED Backlight

Item	Symbol	Min.	Typ.	Max.	Units	Note	
LED Input Voltage	V_{LED}	6	12	21	V	(2)	
LED Forward Voltage	V_F	(2.8)	(3.0)	(3.4)	V	(2)	
LED Forward Current	I_F	-	(20)	-	mA		
PWM Signal Voltage	V_{PWM_EN}	High	2.0	3.3	3.6		V
		Low	0	-	0.5		
LED Enable Voltage	V_{LED_EN}	High	2.0	3.3	3.6		V
		Low	0	-	0.5		
Input PWM Frequency	FPWM	200	-	1,000	Hz		
LED Life Time	LT	15,000	-	-	Hours	(1)(2)	
Duty Ratio	PWM	(1)	-	100	%	(2)	

Note (1) The LED life time define as the estimated time to 50% degradation of initial luminous.

Note (2) Operating temperature 25°C , humidity 55%.

InfoVision Optoelectronics (Kunshan) Co.,LTD.

	Document Name	N1251 R0 Module Product Specification			Page 12 of 28	
	Document No.	E-M125NWN1-R0	Made/Revised Date	2012/08/03	Ver.	00
	Made By	杨丹丹	Department	DQA	Factory Code	00

6.0 Electrical Characteristics

6.1 Interface Connector

Table 5 Connector Name / Designation

Manufacturer	Starconn
Type / Part Number	300E30-0010RA-G3
Mating Receptacle/Part Number	111B30-1210TA-G3

Table 6 Signal Pin Assignment

Pin	Signal Name	Description	Remarks
1	NC-Reserved	Reserved for LCD manufacture's use	-
2	H_GND	High Speed Ground	-
3	Lane 1_N	Complement Signal Link Lane 1	-
4	Lane 1_P	True Signal Line 1	-
5	H_GND	High Speed Ground	-
6	Lane 0_N	Complement Signal Link Lane 0	-
7	Lane 0_P	True Signal Line 0	-
8	H_GND	High Speed Ground	-
9	AUX_CH_P	True Signal Auxiliary Ch.	-
10	AUX_CH_N	Complement Signal Auxiliary Ch.	-
11	H_GND	High Speed Ground	-
12	LCD_VCC	LCD Logic and Driver Power	+3.3V
13	LCD_VCC	LCD Logic and Driver Power	+3.3V
14	LCD_Self Test or NC	LCD Panel Self-Test Enable(optional)	-
15	LCD_GND	LCD logic and driver ground	-
16	LCD_GND	LCD logic and driver ground	-
17	HPD	HPD Signal Pin	-
18	BL_GND	Backlight ground	-
19	BL_GND	Backlight ground	-
20	BL_GND	Backlight ground	-
21	BL_GND	Backlight ground	-
22	BL_ENABLE	Backlight On/Off	-
23	BL_PWM_DIM	System PWM Signal Input for Dimming	-
24	NC	Not connected	-
25	NC	Not connected	-
26	BL_PWR	Backlight Power	+12V

InfoVision Optoelectronics (Kunshan) Co.,LTD.

	Document Name	N1251 R0 Module Product Specification			Page 13 of 28	
	Document No.	E-M125NWN1-R0	Made/Revised Date	2012/08/03	Ver.	00
	Made By	杨丹丹	Department	DQA	Factory Code	00

27	BL_PWR	Backlight Power	+12V
28	BL_PWR	Backlight Power	+12V
29	BL_PWR	Backlight Power	+12V
30	NC_RESERVED	Reserved for LCD manufacture's use	-

Note : All input signals shall be low or Hi- resistance state when VDD is off.

6.2 Signal Electrical Characteristics

Input signals shall be low or High-impedance state when VDD is off.

It is recommended to refer the specifications of VESA Display Port Standard V1.1a in detail.

Table 7 Display Port Main Link

Parameter	Description	Min.	Typ.	Max.	Unit
V_{CM}	Differentia Common Mode Voltage	0	-	2.0	V
$V_{DIFF P-P}$ Level 1	Differential Peak to Peak Voltage Level 1	0.34	0.40	0.46	V
$V_{DIFF P-P}$ Level 2	Differential Peak to Peak Voltage Level 2	0.51	0.60	0.68	V
$V_{DIFF P-P}$ Level 3	Differential Peak to Peak Voltage Level 3	0.69	0.80	0.92	V
$V_{DIFF P-P}$ Level 4	Differential Peak to Peak Voltage Level 4	1.02	1.20	1.38	V

Note: Follow as VESA display port standard V1.1a at both 1.62 and 2.7Gbps link rates

Figure 9 Display Port Main Link Signal

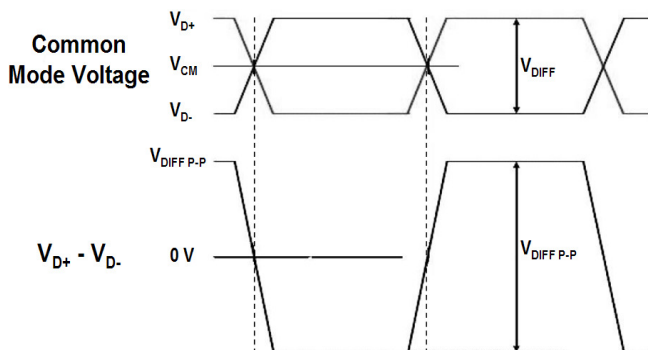
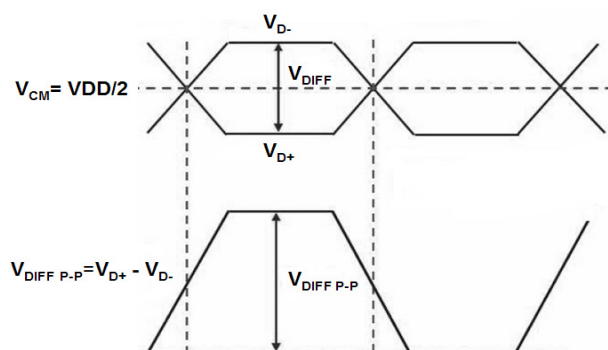

Figure 10 Display Port AUX_CH Signal



InfoVision Optoelectronics (Kunshan) Co.,LTD.

	Document Name	N1251 R0 Module Product Specification			Page 14 of 28	
	Document No.	E-M125NWN1-R0	Made/Revised Date	2012/08/03	Ver.	00
	Made By	杨丹丹	Department	DQA	Factory Code	00

Table 8 Display Port AUX_CH

Parameter	Description	Min.	Typ.	Max.	Unit
V_{CM}	Differentia Common Mode Voltage	0	VDD/2	2	V
$V_{Diff P-P}$	Differential Peak to Peak Voltage	0.39	-	1.38	V

Note: Follow as VESA display port standard V1.1a

Table 9 Display Port V_{HPD}

Parameter	Description	Min.	Typ.	Max.	Unit
V_{HPD}	HPD Voltage	2.25	-	3.60	V

Note: Follow as VESA display port standard V1.1a

Figure 11 Display Port Interface Power Up/Down Sequence, Normal System Operation (Reference)

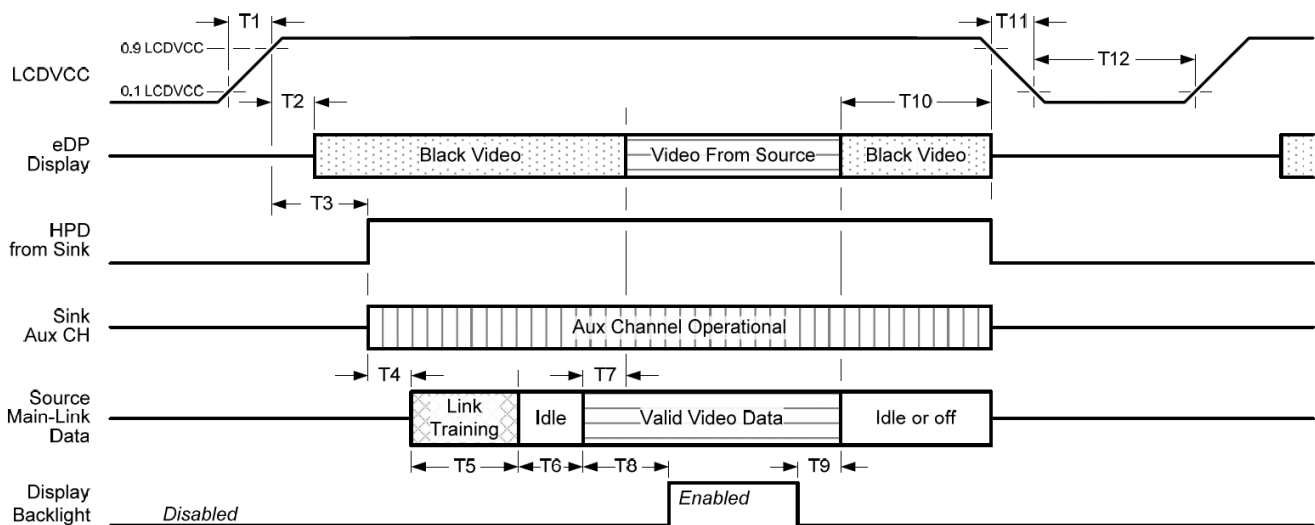

InfoVision Optoelectronics (Kunshan) Co.,LTD.

	Document Name	N1251 R0 Module Product Specification			Page 15 of 28	
	Document No.	E-M125NWN1-R0	Made/Revised Date	2012/08/03	Ver.	00
	Made By	杨丹丹	Department	DQA	Factory Code	00

Figure 12 Display Port Interface Power Up/Down Sequence, Aux Channel Transaction Only (Reference)



InfoVision Optoelectronics (Kunshan) Co.,LTD.

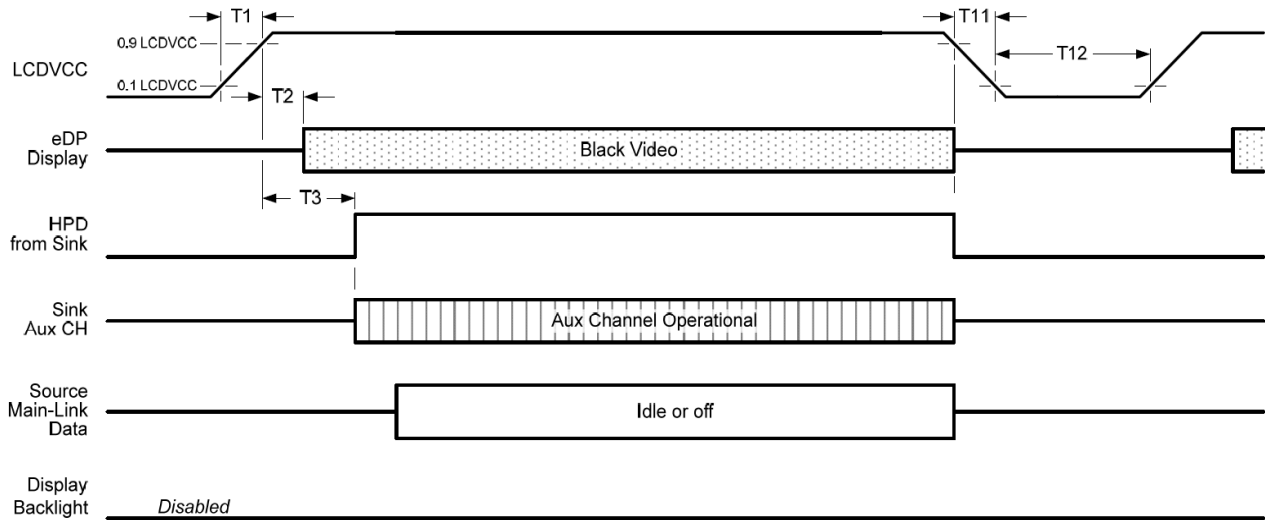

	Document Name	N1251 R0 Module Product Specification			Page 16 of 28	
	Document No.	E-M125NWN1-R0	Made/Revised Date	2012/08/03	Ver.	00
	Made By	杨丹丹	Department	DQA	Factory Code	00

Table 10 eDP Panel Power Sequence Timing Parameters (Reference)

Timing Parameter	Description	Reqd. By	Limits		Notes
			Min.	Max.	
T1	Power rail rise time, 10% to 90%	Source	0.5ms	10ms	-
T2	Delay from LCD VCC to black video generation	Sink	0ms	200ms	Prevents display noise until valid video data is received from the Source.(see note 1 below)
T3	Delay from LCD VCC to HPD high	Sink	0ms	200ms	Sink Aux Channel must be operational upon HPD high.
T4	Delay from HPD high to link training initialization	Source	-	-	Allows for Source to read Link capability and initialize.
T5	Link training duration	Source	-	-	Dependant on Source link training protocol.
T6	Link idle	Source	-	-	Min accounts for required BS-Idle pattern. Max allows for Source frame synchronization.
T7	Delay from valid video data from Source to video on display	Sink	0ms	50ms	Max allows Sink validate video data and timing.
T8	Delay from valid video from Source to backlight enable	Source	-	-	Source must assure display video is stable.
T9	Delay from backlight disable to end of valid video data	Source	-	-	Source must assure backlight is no longer illuminated.(see note 1 below)
T10	Delay from end of valid video data from Source to power off	Source	0ms	500ms	-
T11	Power rail fall time, 90% to 10%	Source	-	10ms	-

InfoVision Optoelectronics (Kunshan) Co.,LTD.

	Document Name	N1251 R0 Module Product Specification			Page 17 of 28	
	Document No.	E-M125NWN1-R0	Made/Revised Date	2012/08/03	Ver.	00
	Made By	杨丹丹	Department	DQA	Factory Code	00

T12	Power off time	Source	500ms	-	-
-----	----------------	--------	-------	---	---

Note (1): The Sink must include the ability to generate black video autonomously. The Sink must automatically enable black video under the following conditions:

- Upon LCDVCC power-on (within T2 max)
- When the “NoVideoStream_Flag” (VB-ID Bit 3) is received from the Source (at the end of T9)
- When no Main Link data, or invalid video data, is received from the Source. Black video must be displayed within 50ms (max) from the start of either condition. Video data can be deemed invalid based on MSA and timing information, for example.

Note (2): The Sink may implement the ability to disable the black video function, as described in Notes (1)above, for system development and debugging purposes.

Note (3): The Sink must support Aux Channel polling by the Source immediately following LCDVCC power-on without causing damage to the Sink device (the Source can re-try if the Sink is not ready). The Sink must be able to respond to an Aux Channel transaction with the time specified within T3 max.

InfoVision Optoelectronics (Kunshan) Co.,LTD.

	Document Name	N1251 R0 Module Product Specification			Page 18 of 28	
	Document No.	E-M125NWN1-R0	Made/Revised Date	2012/08/03	Ver.	00
	Made By	杨丹丹	Department	DQA	Factory Code	00

7.0 Interface Timings

Basically, interface timings should match the 1366 x 768 /60Hz manufacturing guide line timing.

Table 11 Interface Timings

Parameter	Symbol	Unit	Min.	Typ.	Max.
Pixel Clock Frequency	f_{dck}	MHz	(70.44)	(77)	(80)
H Total Time	T_{hp}	clocks	(1520)	(1560)	(1606)
H Active Time	HA	clocks	1366		
H Blanking	T_{hfp}	clocks	-	(194)	-
H Frequency	f_h	kHz	45.21	(49.32)	(53.43)
V Total Time	T_{vp}	lines	(778)	(822)	(830)
V Active Time	VA	lines	768		
V Blanking	T_{vfp}	lines	-	(54)	-
Frame Rate	V_{sync}	Hz	(55)	60	(65)

Note:SDRRS Support (40HZ)

InfoVision Optoelectronics (Kunshan) Co.,LTD.

	Document Name	N1251 R0 Module Product Specification			Page 19 of 28	
	Document No.	E-M125NWN1-R0	Made/Revised Date	2012/08/03	Ver.	00
	Made By	杨丹丹	Department	DQA	Factory Code	00

8.0 Power Consumption

Input power specifications are as follows.

Table 12 Power Consumption

Item	Symbol	Min.	Typ.	Max.	Units	Note	
Logic/LCD Drive Voltage	VDD	3.0	3.3	3.6	V	(2), (4)	
VDD Current	Black Pattern	IDD _{Black}	-	TBD	(0.243)	A	(3),(4)
VDD Power Consumption	PDD _{Black}	-	-	(0.8)	W		
LED Power Consumption	P _{LED}	-	-	(2.5)	W		
Rush Current	Inrush	-	-	1.5	A	(1),(4)	
Allowable Logic/LCD Drive Ripple Voltage	VDDrp	-	-	200	mV	(4)	

Note (1) Measure Condition

Figure 13 VDD Rising Time

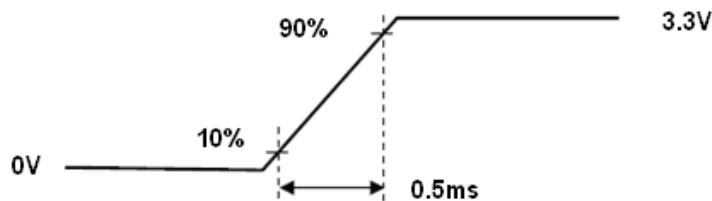

Note (2) VDD Power Dip Condition

Figure 14 VDD Power Dip

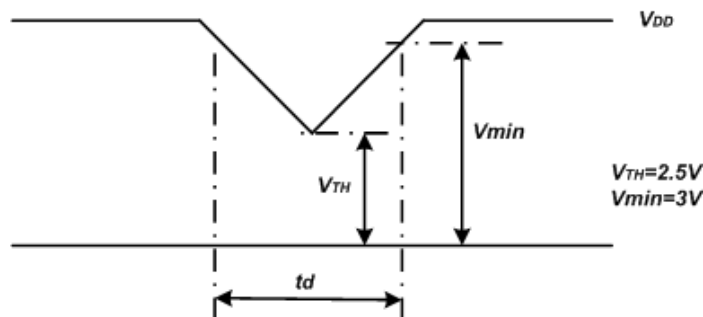

If $V_{TH} < V_{DD} \leq V_{min}$, then $t_d \leq 10ms$; when the voltage return to normal our panel must revive automatically.

Note (3) $f_v=60Hz$, $V_{DD}=3.3V$, DC Current.

Note (4) Operating temperature $25^\circ C$, humidity 55%.

	Document Name	N1251 R0 Module Product Specification			Page 20 of 28	
	Document No.	E-M125NWN1-R0	Made/Revised Date	2012/08/03	Ver.	00
	Made By	杨丹丹	Department	DQA	Factory Code	00

9.0 Power ON/OFF Sequence

VDD power on/off sequence is as follows. Interface signals are also shown in the chart. Signals from any system shall be Hi- resistance state or low level when VDD is off.

Figure 15 Power Sequence

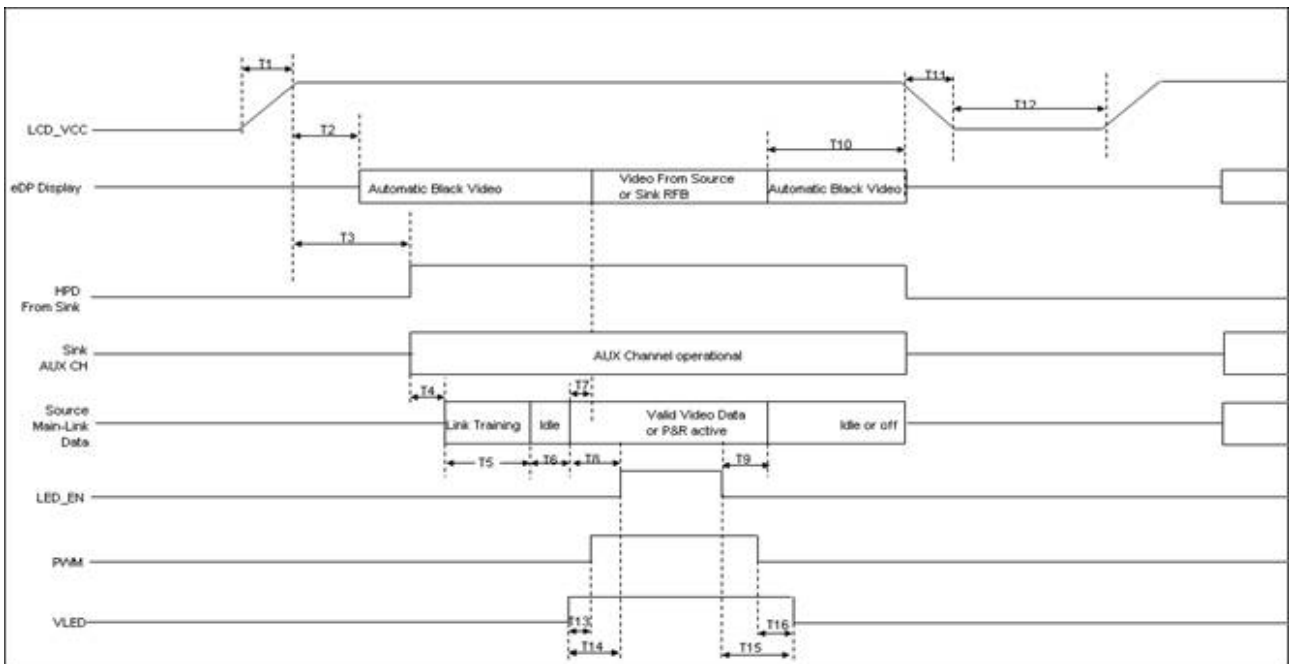



Table 13 Power Sequencing Requirements

Parameter	Unit	Min.	Max.
T1	ms	0.5	10
T2	ms	0	200
T3	ms	0	200
T7	ms	0	50
T10	ms	0	500
T11	ms	0	10
T12	ms	150	-
T13	ms	0	-
T14	ms	0	-
T15	ms	0	-
T16	ms	0	-

InfoVision Optoelectronics (Kunshan) Co.,LTD.

	Document Name	N1251 R0 Module Product Specification			Page 21 of 28	
	Document No.	E-M125NWN1-R0	Made/Revised Date	2012/08/03	Ver.	00
	Made By	杨丹丹	Department	DQA	Factory Code	00

10.0 Mechanical Characteristics

10.1 Outline Drawing

Figure 16 Reference Outline Drawing (Front Side)

TBD

InfoVision Optoelectronics (Kunshan) Co.,LTD.



	Document Name	N1251 R0 Module Product Specification			Page 22 of 28	
	Document No.	E-M125NWN1-R0	Made/Revised Date	2012/08/03	Ver.	00
	Made By	杨丹丹	Department	DQA	Factory Code	00

Figure 17 Reference Outline Drawing (Back Side)

TBD

InfoVision Optoelectronics (Kunshan) Co.,LTD.

	Document Name	N1251 R0 Module Product Specification			Page 23 of 28	
	Document No.	E-M125NWN1-R0	Made/Revised Date	2012/08/03	Ver.	00
	Made By	杨丹丹	Department	DQA	Factory Code	00

10.2 Dimension Specifications

Table 14 Module Dimension Specifications

Item	Min.	Typ.	Max.	Units
Width	(290.00)	290.50	(291.00)	mm
Height	(180.90)	181.40	(181.90)	mm
Thickness	-	-	(3.0)	mm
Weight	TBD	TBD	(250)	g

Measure Instrument: Vernier Caliper

InfoVision Optoelectronics (Kunshan) Co.,LTD.

	Document Name	N1251 R0 Module Product Specification			Page 24 of 28	
	Document No.	E-M125NWN1-R0	Made/Revised Date	2012/08/03	Ver.	00
	Made By	杨丹丹	Department	DQA	Factory Code	00

11.0 Package Specification

Figure 18 Packing Method

TBD

InfoVision Optoelectronics (Kunshan) Co.,LTD.

	Document Name	N1251 R0 Module Product Specification			Page 25 of 28	
	Document No.	E-M125NWN1-R0	Made/Revised Date	2012/08/03	Ver.	00
	Made By	杨丹丹	Department	DQA	Factory Code	00

12.0 Lot Mark

TBD

12.1 Lot Mark

1	2	3	4	5	6	7	8	9	10	11	12	13	14	15	16	17	18	19	20
---	---	---	---	---	---	---	---	---	----	----	----	----	----	----	----	----	----	----	----

code 1,2,4,5,6,7,8,9,10,11,16: IVO internal flow control code.

code 3: Production location.

code 12: Production year.

code 13: Production month.

code 14,15: Production date.

code 17,18,19,20: Serial number.

Note (1) Production Year

Year	2,006	2,007	2,008	2,009	2,010	2,011	2,012	2,013	2,014	2,015
Mark	6	7	8	9	A	B	C	D	E	F

Note (2) Production Month

Month	Jan.	Feb.	Mar.	Apr.	May.	Jun.	Jul.	Aug.	Sep.	Oct	Nov.	Dec.
Mark	1	2	3	4	5	6	7	8	9	A	B	C

12.2 22 Product Barcode

1	2	3	4	5	6	7	8	9	10	11	12	13	14	15	16	17	18	19	20	21	22	23
---	---	---	---	---	---	---	---	---	----	----	----	----	----	----	----	----	----	----	----	----	----	----

Code 1,2,3: Customer Code

Code 4,5,6,7,8,9,10: Lenovo Parts Number

Code 11: Customer Code

Code 12,13,14,15,16: Lenovo H/C

Code 17,18,19,20,21,22 : Serial Number

InfoVision Optoelectronics (Kunshan) Co.,LTD.

	Document Name	N1251 R0 Module Product Specification			Page 26 of 28	
	Document No.	E-M125NWN1-R0	Made/Revised Date	2012/08/03	Ver.	00
	Made By	杨丹丹	Department	DQA	Factory Code	00

13.0 General Precaution

13.1 Use Restriction

This product is not authorized for use in life supporting systems, aircraft navigation control systems, military systems and any other application where performance failure could be life-threatening or otherwise catastrophic.

13.2 Handling Precaution

- (1) Please mount LCD module by using mounting holes arranged in four corners tightly.
- (2) Do not disassemble or modify the module. It may damage sensitive parts inside LCD module, and may cause scratches or dust on the display. IVO does not warrant the module, if customers disassemble or modify the module.
- (3) If LCD panel is broken and liquid crystal spills out, do not ingest or inhale liquid Crystal, and do not contact liquid crystal with skin. If liquid crystal contacts mouth or eyes, rinse out with water immediately. If liquid crystal contacts skin or cloths, wash it off immediately with alcohol and Rinse thoroughly with water.
- (4) Disconnect power supply before handling LCD module
- (5) Refrain from strong mechanical shock and /or any force to the module.
- (6) Do not exceed the absolute maximum rating values, such as the supply voltage variation, input voltage variation, variation in parts' parameters, environmental temperature; etc otherwise LCD module may be damaged. It's recommended employing protection circuit for power supply.
- (7) Do not touch, push or rub the polarizer with anything harder than HB pencil lead. Use fingerstalls of soft gloves in order to keep clean display quality, when Persons handle the LCD module for incoming inspection or assembly.
- (8) When the surface is dusty, please wipe gently with absorbent cotton or other soft Material. When cleaning the adhesives, please use absorbent cotton wetted with a little Petroleum benzene or other adequate solvent.
- (9) Wipe off saliva or water drops as soon as possible. If saliva or water drops Contact with polarizer for a long time, they may causes deformation or color Fading.
- (10) Protection film must remove very slowly from the surface of LCD module to Prevent from electrostatic occurrence.
- (11) Because LCD module uses CMOS-IC on circuit board and TFT-LCD panel, it is Very weak to electrostatic discharge, Please be careful with electrostatic Discharge .Persons who handle the module should be grounded through adequate methods.
- (12) Do not adjust the variable resistor located on the module.

13.3 Storage Precaution

- (1) Please do not leave LCD module in the environment of high humidity and high temperature for a long time.
- (2) The module shall not be exposed under strong light such as direct sunlight. Otherwise, Display characteristics may be changed.
- (3) The module should be stored in a dark place. It is prohibited to apply sunlight or fluorescent light in storage.

13.4 Operation Precaution

- (1) Do not connect or disconnect the module in the "Power On" condition.
- (2) Power supply should always be turned on/off by "Power on/off sequence"
- (3) Module has high frequency circuits. Sufficient suppression to the electromagnetic

InfoVision Optoelectronics (Kunshan) Co.,LTD.

	Document Name	N1251 R0 Module Product Specification			Page 27 of 28	
	Document No.	E-M125NWN1-R0	Made/Revised Date	2012/08/03	Ver.	00
	Made By	杨丹丹	Department	DQA	Factory Code	00

interference should be done by system manufacturers. Grounding and shielding methods may be important to minimize the interference.

- (4) After installation of the TFT Module into an enclosure, do not twist nor bend the TFT Module even momentary. At designing the enclosure, it should be taken into consideration that no bending/twisting forces are applied to the TFT Module from outside. Otherwise the TFT Module may be damaged.

13.5 Others

- (1) Ultra-violet ray filter is necessary for outdoor operation.
- (2) Avoid condensation of water which may result in improper operation or disconnection of electrode.
- (3) If the module keeps displaying the same pattern for a long period of time, the image may be "Sticked" to the screen.
- (4) This module has its circuitry PCB's on the rear side and should be handled carefully in order not to be stressed.

13.6 Disposal

When disposing LCD module, obey the local environmental regulations.

InfoVision Optoelectronics (Kunshan) Co.,LTD.

	Document Name	N1251 R0 Module Product Specification			Page 28 of 28	
	Document No.	E-M125NWN1-R0	Made/Revised Date	2012/08/03	Ver.	00
	Made By	杨丹丹	Department	DQA	Factory Code	00

14.0 EDID Data Structure

Table 15 EDID Table Format

TBD