

CONTENTS

1. GENERAL DESCRIPTION	5
1.1 OVERVIEW	5
1.2 GENERAL SPECIFICATIONS	5
2. MECHANICAL SPECIFICATIONS	5
2.1 CONNECTOR TYPE	6
3. ABSOLUTE MAXIMUM RATINGS	6
3.1 ABSOLUTE RATINGS OF ENVIRONMENT	6
3.2 ELECTRICAL ABSOLUTE RATINGS	7
3.2.1 TFT LCD MODULE	7
4. ELECTRICAL SPECIFICATIONS.....	8
4.1 FUNCTION BLOCK DIAGRAM	8
4.2. INTERFACE CONNECTIONS	8
4.3 ELECTRICAL CHARACTERISTICS	10
4.3.1 LCD ELETRONICS SPECIFICATION	10
4.3.2 LED CONVERTER SPECIFICATION	12
4.3.3 BACKLIGHT UNIT	14
4.4 DISPLAY PORT INPUT SIGNAL TIMING SPECIFICATIONS	15
4.4.1 DISPLAY PORT INTERFACE	15
4.4.2 COLOR DATA INPUT ASSIGNMENT	16
4.5 DISPLAY TIMING SPECIFICATIONS	17
4.6 POWER ON/OFF SEQUENCE	18
5. OPTICAL CHARACTERISTICS	21
5.1 TEST CONDITIONS	21
5.2 OPTICAL SPECIFICATIONS	21
6. RELIABILITY TEST ITEM	24
7. PACKING	25
7.1 MODULE LABEL	25
7.2 CARTON	26
7.3 PALLET	27
7.4 UN-PACKAGING METHOD	28
8. PRECAUTIONS	29
8.1 HANDLING PRECAUTIONS	29
8.2 STORAGE PRECAUTIONS	29
8.3 OPERATION PRECAUTIONS	29
Appendix. EDID DATA STRUCTURE	30
Appendix. OUTLINE DRAWING	33
Appendix. SYSTEM COVER DESIGN GUIDANCE	35

Appendix. LCD MODULE HANDLING MANUAL..... 43

PRODUCT SPECIFICATION

REVISION HISTORY

Version	Date	Page	Description
3.0	Apr. 1, 2013	All	Approval Spec Ver.3.0 was first issued.
3.1	Apr. 4, 2014	P.5,P.12, P.14,P.21 ,P28,	Spec was modified due to "Brightness changes from 200nits to 220nits "
		P.5	Add " 2.MECHANICAL SPECIFICATIONS 'S Note (2) "
		P.35	Modify " Appendix. SYSTEM COVER DESIGN NOTICE"
		P.43	Add" Appendix. LCD MODULE HANDLING MANUAL"

1. GENERAL DESCRIPTION

1.1 OVERVIEW

N140BGE-E43 is a 14.0" (14.0" diagonal) TFT Liquid Crystal Display module with LED Backlight unit and 30 pins eDP interface. This module supports 1366 x 768 HD mode and can display 262,144 colors.

The optimum viewing angle is at 6 o'clock direction.

1.2 GENERAL SPECIFICATIONS

Item	Specification	Unit	Note
Screen Size	14.0" diagonal		
Driver Element	a-si TFT active matrix	-	-
Pixel Number	1366 x R.G.B. x 768	pixel	-
Pixel Pitch	0.2265 (H) x 0.2265 (V)	mm	-
Pixel Arrangement	RGB vertical stripe	-	-
Display Colors	262,144	color	-
Transmissive Mode	Normally white	-	-
Surface Treatment	Hard coating (3H), Glare	-	-
Luminance, White	220	Cd/m2	
Power Consumption	Total 3.12W (Max.)@cell 0.8 W (Max.), BL 2.32W(Max.)		(1)

Note (1) The specified power consumption (with converter efficiency) is under the conditions at VCCS = 3.3 V, fv = 60 Hz, LED_VCCS = Typ, fPWM = 200 Hz, Duty=100% and Ta = 25 ± 2 °C, whereas mosaic pattern is displayed.

2. MECHANICAL SPECIFICATIONS

Item		Min.	Typ.	Max.	Unit	Note
Module Size	Horizontal (H)	319.9	320.4	320.9	mm	(1) (2)
	Vertical (V)	186.6	187.1	187.6	mm	
	Vertical (V) with PCB & Bracket	204.6	205.1	205.6	mm	
	Thickness (T)	-	-	3.6	mm	
	Thickness (T) with PCB & Bracket	-	-	3.6	mm	Slim Bend
Polarizer Area	Horizontal	312.4	312.7	313.0	mm	
	Vertical	177.05	177.25	177.45	mm	
Active Area	Horizontal	309.299	309.399	309.499	mm	
	Vertical	173.852	173.952	174.052	mm	
Weight		-	310	320	g	

Note (1) Please refer to the attached drawings for more information of front and back outline dimensions.

Note (2) Dimensions are measured by caliper.

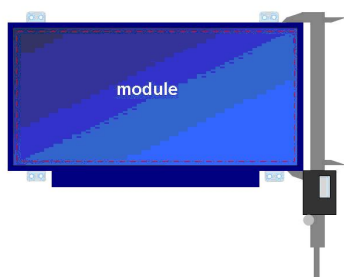

2.1 CONNECTOR TYPE

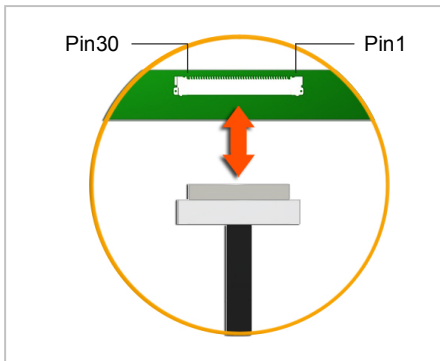

Please refer Appendix Outline Drawing for detail design.

Connector Part No.: IPEX-20455-030E-12

User's connector Part No: IPEX-20453-030T-01

3. ABSOLUTE MAXIMUM RATINGS

3.1 ABSOLUTE RATINGS OF ENVIRONMENT

Item	Symbol	Value		Unit	Note
		Min.	Max.		
Storage Temperature	T _{ST}	-20	+60	°C	(1)
Operating Ambient Temperature	T _{OP}	0	+50	°C	(1), (2)

Note (1) (a) 90 %RH Max. (Ta < 40 °C).

(b) Wet-bulb temperature should be 39 °C Max. (Ta < 40 °C).

(c) No condensation.

Note (2) The temperature of panel surface should be 0 °C min. and 60 °C max.

Relative Humidity (%RH)

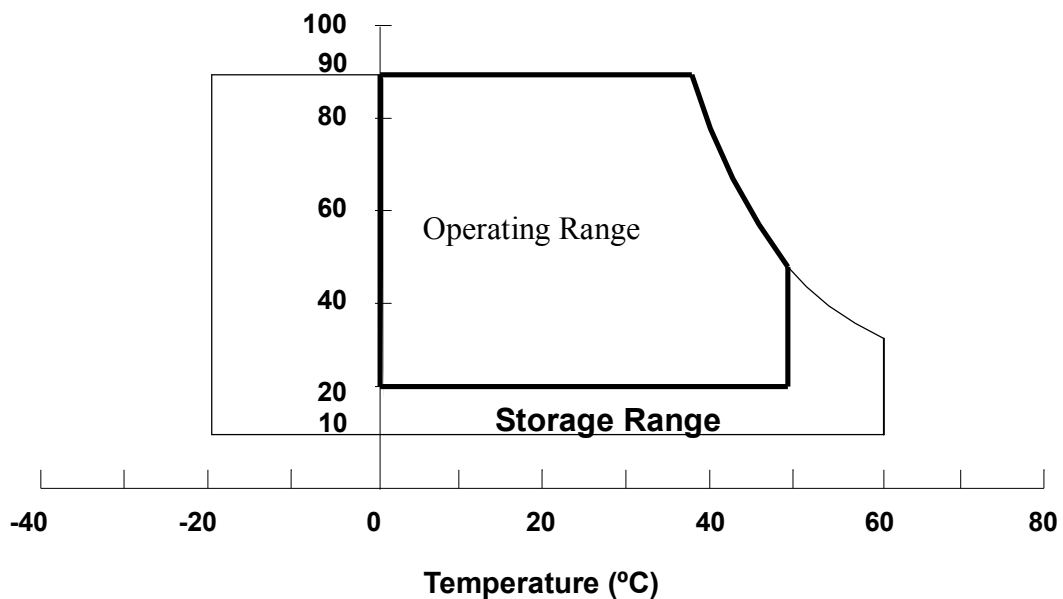

3.2 ELECTRICAL ABSOLUTE RATINGS

3.2.1 TFT LCD MODULE

Item	Symbol	Value		Unit	Note
		Min.	Max.		
Power Supply Voltage	VCCS	-0.3	+4.0	V	(1)
Logic Input Voltage	V _{IN}	-0.3	VCCS+0.3	V	
Converter Input Voltage	LED_VCCS	-0.3	26	V	(1)
Converter Control Signal Voltage	LED_PWM,	-0.3	5	V	(1)
Converter Control Signal Voltage	LED_EN	-0.3	5	V	(1)

Note (1) Stresses beyond those listed in above “ELECTRICAL ABSOLUTE RATINGS” may cause permanent damage to the device. Normal operation should be restricted to the conditions described in “ELECTRICAL CHARACTERISTICS”.

4. ELECTRICAL SPECIFICATIONS

4.1 FUNCTION BLOCK DIAGRAM

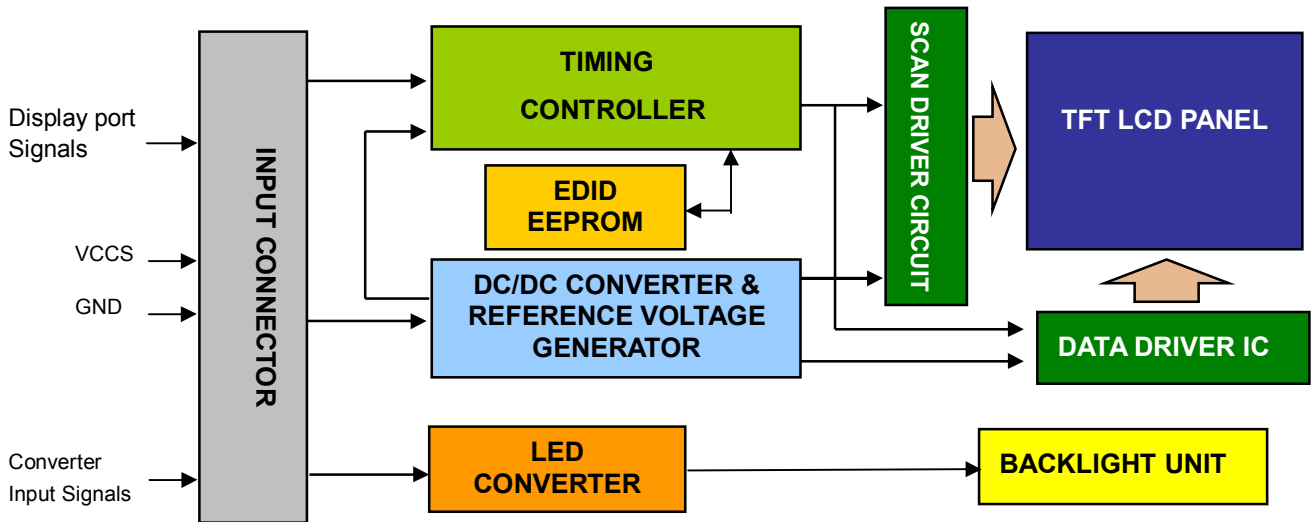

4.2. INTERFACE CONNECTIONS

PIN ASSIGNMENT

Pin	Symbol	Description	Remark
1	NC	No Connection (Reserved for LCD test)	
2	H_GND	High Speed Ground	
3	NC	No Connection (Reserved for LCD test)	
4	NC	No Connection (Reserved for LCD test)	
5	H_GND	High Speed Ground	
6	ML0-	Complement Signal-Lane 0	
7	ML0+	True Signal-Main Lane 0	
8	H_GND	High Speed Ground	
9	AUX+	True Signal-Auxiliary Channel	
10	AUX-	Complement Signal-Auxiliary Channel	
11	H_GND	High Speed Ground	
12	VCCS	Power Supply +3.3 V (typical)	
13	VCCS	Power Supply +3.3 V (typical)	
14	NC	No Connection (Reserved for LCD test)	
15	GND	Ground	
16	GND	Ground	
17	HPD	Hot Plug Detect	
18	BL_GND	BL Ground	
19	BL_GND	BL Ground	
20	BL_GND	BL Ground	
21	BL_GND	BL Ground	
22	LED_EN	BL_Enable Signal of LED Converter	
23	LED_PWM	PWM Dimming Control Signal of LED Converter	
24	NC	No Connection (Reserved for LCD test)	
25	NC	No Connection (Reserved for LCD test)	

PRODUCT SPECIFICATION

26	LED_VCCS	BL Power	
27	LED_VCCS	BL Power	
28	LED_VCCS	BL Power	
29	LED_VCCS	BL Power	
30	NC	No Connection (Reserved for LCD test)	

Note (1) The first pixel is odd as shown in the following figure.

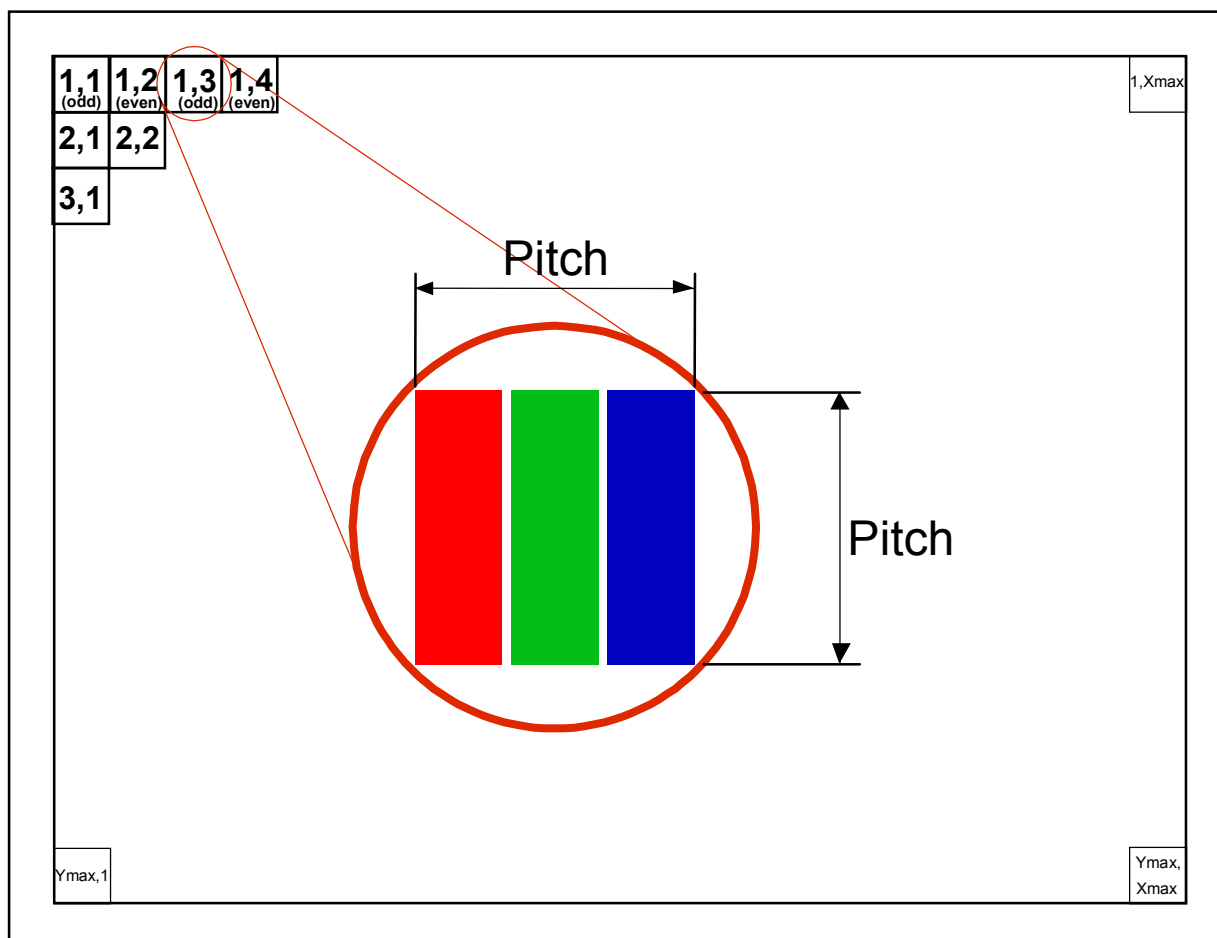

4.3 ELECTRICAL CHARACTERISTICS

4.3.1 LCD ELETRONICS SPECIFICATION

Parameter		Symbol	Value			Unit	Note
			Min.	Typ.	Max.		
Power Supply Voltage		VCCS	3.0	3.3	3.6	V	(1)
HPD	High Level		2.25	-	2.75	V	(4)
	Low Level		0	-	0.4	V	(4)
HPD Impedance		R _{HPD}	30K			ohm	(4)
Ripple Voltage		V _{RP}	-	50	-	mV	(1)
Inrush Current		I _{RUSH}	-	-	1.5	A	(1),(2)
Power Supply Current	Mosaic	I _{CC}		220	242	mA	(3)a
	Black			215	242	mA	(3)

Note (1) The ambient temperature is Ta = 25 ± 2 °C.

Note (2) I_{RUSH}: the maximum current when VCCS is rising

I_{IS}: the maximum current of the first 100ms after power-on

Measurement Conditions: Shown as the following figure. Test pattern: black.

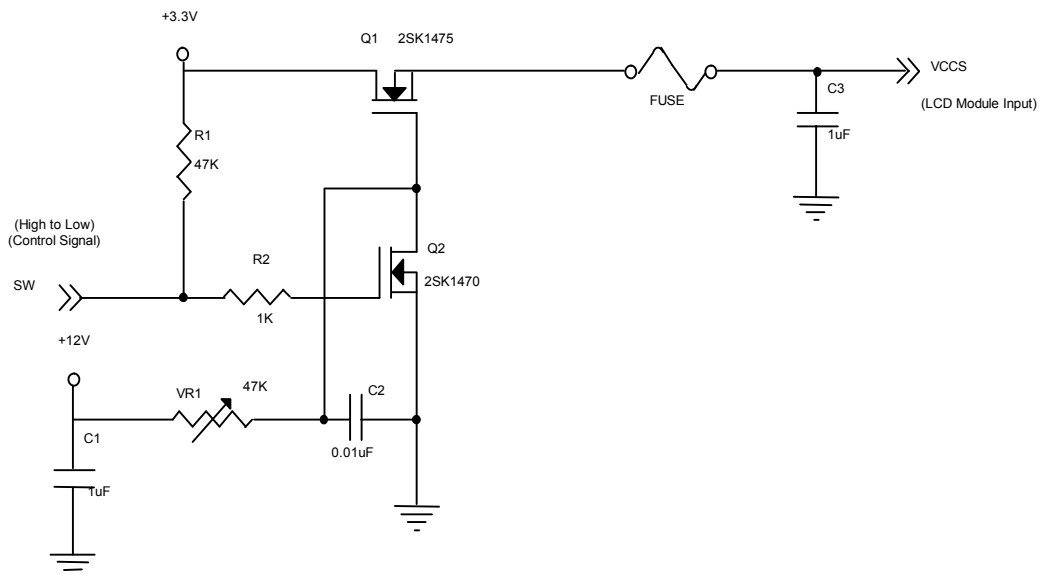

VCCS rising time is 0.5ms

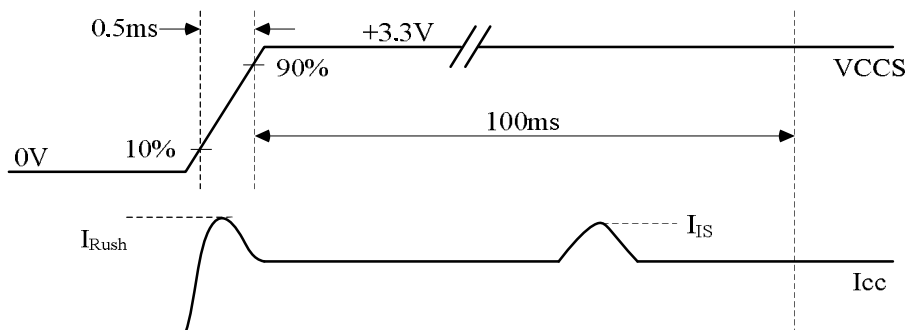

Note (3) The specified power supply current is under the conditions at $V_{CCS} = 3.3\text{ V}$, $T_a = 25 \pm 2\text{ }^\circ\text{C}$, DC Current and $f_v = 60\text{ Hz}$, whereas a power dissipation check pattern below is displayed.

a. Mosaic Pattern

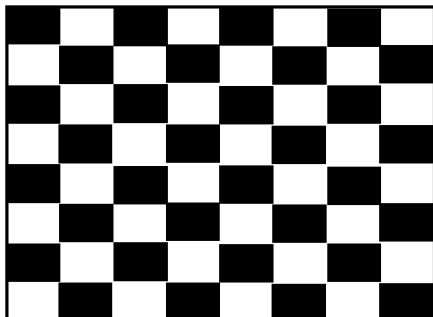

Active Area

Note (4) The specified signals have equivalent impedances pull down to ground in the LCD module respectively. Customers should keep the input signal level requirement with the load of LCD module. Please refer to Note (4) of 4.3.2 LED CONVERTER SPECIFICATION to obtain more information.

4.3.2 LED CONVERTER SPECIFICATION

Parameter		Symbol	Value			Unit	Note
			Min.	Typ.	Max.		
Converter Input Power Supply Voltage		LED_Vccs	5	12	21	V	
Converter Inrush Current		I _{LED_RUSH}	-	-	1.5	A	(1)
LED_EN Control Level	Backlight On		2.2	-	5	V	(4)
	Backlight Off		0	-	0.6	V	(4)
LED_EN Impedance		R _{LED_EN}	30K	-	-	ohm	(4)
PWM Control Level	PWM High Level		2.2	-	5	V	(4)
	PWM Low Level		0	-	0.6	V	(4)
PWM Impedance		R _{PWM}	30K	-	-	ohm	(4)
PWM Control Duty Ratio			5	-	100	%	
PWM Control Permissive Ripple Voltage		V _{PWM_pp}	-	-	100	mV	
PWM Control Frequency		f _{PWM}	190	-	2K	Hz	(2)
LED Power Current	LED_VCCS =Typ.	I _{LED}	157	184	193	mA	(3)

Note (1) I_{LED_RUSH}: the maximum current when LED_VCCS is rising,

I_{LED_IS}: the maximum current of the first 100ms after power-on,

Measurement Conditions: Shown as the following figure. LED_VCCS = Typ, Ta = 25 ± 2 °C, f_{PWM} = 200 Hz, Duty=100%.

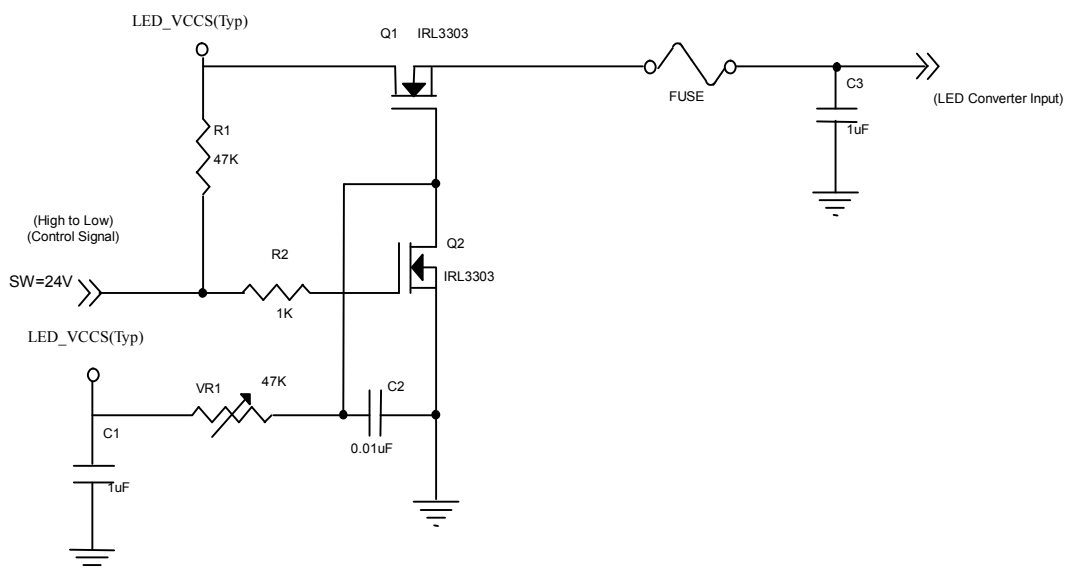

VLED rising time is 0.5ms

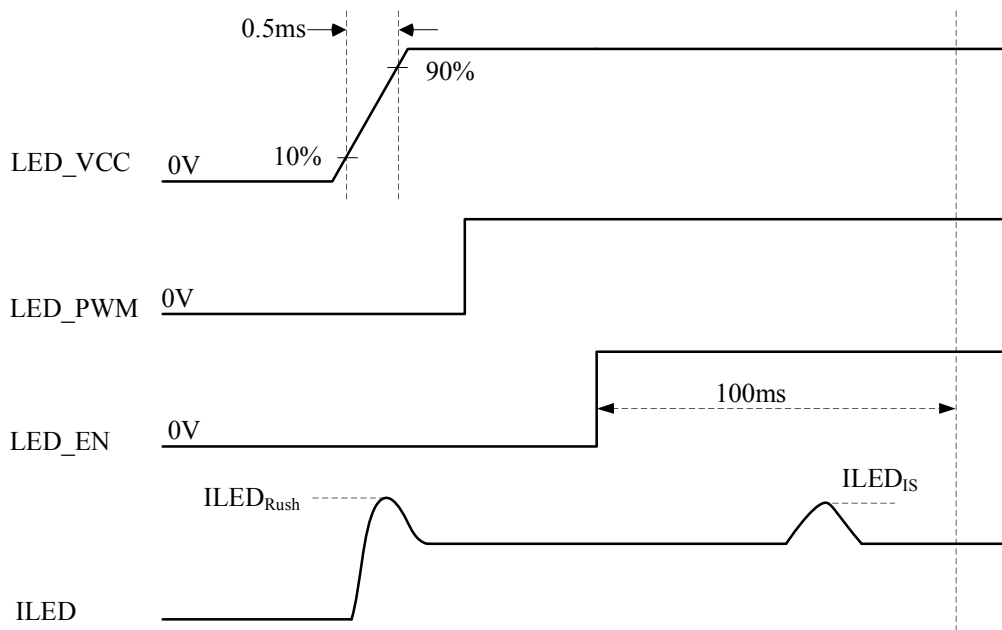

Note (2) If PWM control frequency is applied in the range less than 1KHz, the “waterfall” phenomenon on the screen may be found. To avoid the issue, it’s a suggestion that PWM control frequency should follow the criterion as below.

PWM control frequency f_{PWM} should be in the range

$$(N + 0.33) * f \leq f_{PWM} \leq (N + 0.66) * f$$

N : Integer ($N \geq 3$)

f : Frame rate

Note (3) The specified LED power supply current is under the conditions at “LED_VCCS = Typ.”, $T_a = 25 \pm 2 \text{ }^\circ\text{C}$, $f_{PWM} = 200 \text{ Hz}$, Duty=100%.

Note (4) The specified signals have equivalent impedances pull down to ground in the LCD module respectively. Customers should keep the input signal level requirement with the load of LCD module. For example, the figure below describes the equivalent pull down impedance of LED_EN (if it exists). The rest pull down impedances of other signals (eg. HPD, PWM ...) are in the same concept.

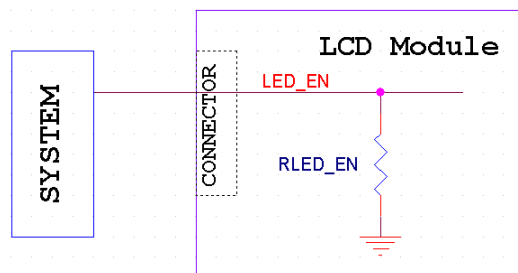

4.3.3 BACKLIGHT UNIT

Ta = 25 ± 2 °C

Parameter	Symbol	Value			Unit	Note
		Min.	Typ.	Max.		
LED Light Bar Power Supply Voltage	V _L	23.4	26.1	27	V	(1)(2)(Duty100%)
LED Light Bar Power Supply Current	I _L	-	69	-	mA	
Power Consumption	P _L	-	1.80	1.86	W	(3)
LED Life Time	L _{BL}	15000	-	-	Hrs	(4)

Note (1) LED current is measured by utilizing a high frequency current meter as shown below :

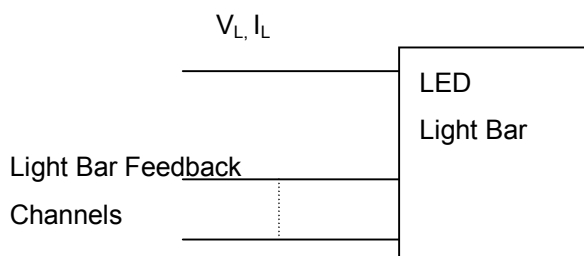

Note (2) For better LED light bar driving quality, it is recommended to utilize the adaptive boost converter with current balancing function to drive LED light-bar.

Note (3) $P_L = I_L \times V_L$ (Without LED converter transfer efficiency)

Note (4) The lifetime of LED is defined as the time when it continues to operate under the conditions at Ta = 25 ± 2 °C and I_L = 23 mA(Per EA) until the brightness becomes ≤ 50% of its original value.

4.4 DISPLAY PORT INPUT SIGNAL TIMING SPECIFICATIONS

4.4.1 DISPLAY PORT INTERFACE

Parameter	Symbol	Min.	Typ.	Max.	Unit	Notes
Differential Signal Common Mode Voltage(MainLink and AUX)	V _{CM}	0		2	V	(1)(3)
AUX AC Coupling Capacitor	C _{AUX}	75		200	nF	(2)

Note (1) Display port interface related AC coupled signals should follow VESA DisplayPort Standard Version1. Revision 1a and VESA Embedded DisplayPort™ Standard Version 1.2. There are many optional items described in eDP1.2. If some optional item is requested, please contact us.

(2) The AUX AC Coupling Capacitor should be placed on Source Devices.

(3)The source device should pass the test criteria described in DisplayPortCompliance Test Specification (CTS) 1.1

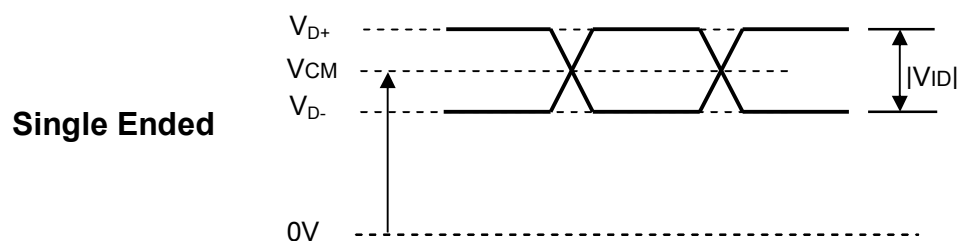

4.4.2 COLOR DATA INPUT ASSIGNMENT

The brightness of each primary color (red, green and blue) is based on the 6-bit gray scale data input for the color. The higher the binary input the brighter the color. The table below provides the assignment of color versus data input.

Color		Data Signal																	
		Red						Green						Blue					
		R5	R4	R3	R2	R1	R0	G5	G4	G3	G2	G1	G0	B5	B4	B3	B2	B1	B0
Basic Colors	Black	0	0	0	0	0	0	0	0	0	0	0	0	0	0	0	0	0	0
	Red	1	1	1	1	1	1	0	0	0	0	0	0	0	0	0	0	0	0
	Green	0	0	0	0	0	0	1	1	1	1	1	1	0	0	0	0	0	0
	Blue	0	0	0	0	0	0	0	0	0	0	0	0	1	1	1	1	1	1
	Cyan	0	0	0	0	0	0	1	1	1	1	1	1	1	1	1	1	1	1
	Magenta	1	1	1	1	1	1	0	0	0	0	0	0	1	1	1	1	1	1
	Yellow	1	1	1	1	1	1	1	1	1	1	1	1	0	0	0	0	0	0
	White	1	1	1	1	1	1	1	1	1	1	1	1	1	1	1	1	1	1
Gray Scale Of Red	Red(0)/Dark	0	0	0	0	0	0	0	0	0	0	0	0	0	0	0	0	0	
	Red(1)	0	0	0	0	0	1	0	0	0	0	0	0	0	0	0	0	0	
	Red(2)	0	0	0	0	1	0	0	0	0	0	0	0	0	0	0	0	0	
	:	:	:	:	:	:	:	:	:	:	:	:	:	:	:	:	:	:	
	:	:	:	:	:	:	:	:	:	:	:	:	:	:	:	:	:	:	
	Red(61)	1	1	1	1	0	1	0	0	0	0	0	0	0	0	0	0	0	
	Red(62)	1	1	1	1	1	0	0	0	0	0	0	0	0	0	0	0	0	
	Red(63)	1	1	1	1	1	1	0	0	0	0	0	0	0	0	0	0	0	
Gray Scale Of Green	Green(0)/Dark	0	0	0	0	0	0	0	0	0	0	0	0	0	0	0	0	0	
	Green(1)	0	0	0	0	0	0	0	0	0	0	0	1	0	0	0	0	0	
	Green(2)	0	0	0	0	0	0	0	0	0	0	1	0	0	0	0	0	0	
	:	:	:	:	:	:	:	:	:	:	:	:	:	:	:	:	:	:	
	:	:	:	:	:	:	:	:	:	:	:	:	:	:	:	:	:	:	
	Green(61)	0	0	0	0	0	0	1	1	1	1	0	1	0	0	0	0	0	
	Green(62)	0	0	0	0	0	0	1	1	1	1	1	0	0	0	0	0	0	
	Green(63)	0	0	0	0	0	0	1	1	1	1	1	1	0	0	0	0	0	
Gray Scale Of Blue	Blue(0)/Dark	0	0	0	0	0	0	0	0	0	0	0	0	0	0	0	0	0	
	Blue(1)	0	0	0	0	0	0	0	0	0	0	0	0	0	0	0	0	1	
	Blue(2)	0	0	0	0	0	0	0	0	0	0	0	0	0	0	0	1	0	
	:	:	:	:	:	:	:	:	:	:	:	:	:	:	:	:	:	:	
	:	:	:	:	:	:	:	:	:	:	:	:	:	:	:	:	:	:	
	Blue(61)	0	0	0	0	0	0	0	0	0	0	0	0	1	1	1	1	0	
	Blue(62)	0	0	0	0	0	0	0	0	0	0	0	0	1	1	1	1	0	
	Blue(63)	0	0	0	0	0	0	0	0	0	0	0	0	1	1	1	1	1	

Note (1) 0: Low Level Voltage, 1: High Level Voltage

4.5 DISPLAY TIMING SPECIFICATIONS

The input signal timing specifications are shown as the following table and timing diagram.

Refresh rate 60Hz

Signal	Item	Symbol	Min.	Typ.	Max.	Unit	Note
DCLK	Frequency	1/Tc	72.60	76.42	78.44	MHz	-
DE	Vertical Total Time	TV	792	800	810	TH	-
	Vertical Active Display Period	TVD	768	768	768	TH	-
	Vertical Active Blanking Period	TVB	TV-TVD	32	TV-TVD	TH	-
	Horizontal Total Time	TH	1582	1592	1614	Tc	-
	Horizontal Active Display Period	THD	1366	1366	1366	Tc	-
	Horizontal Active Blanking Period	THB	TH-THD	226	TH-THD	Tc	-

INPUT SIGNAL TIMING DIAGRAM

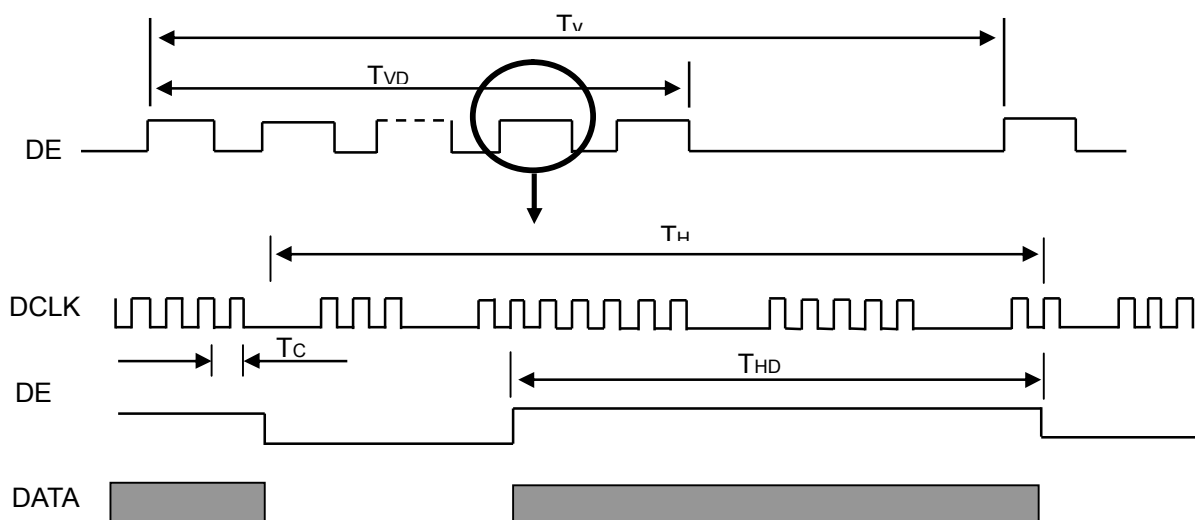

4.6 POWER ON/OFF SEQUENCE

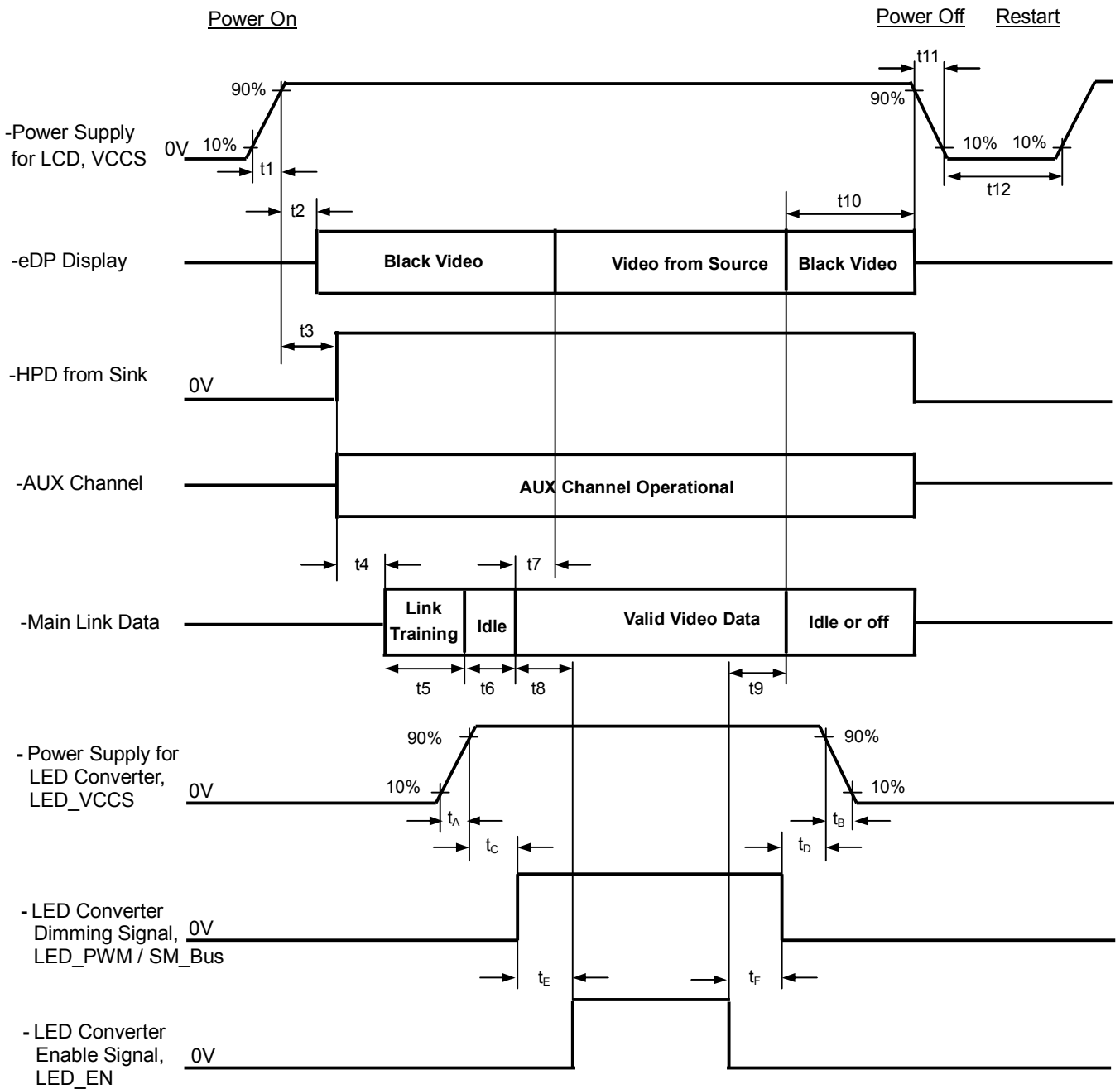

Timing Specifications:

Parameter	Description	Reqd. By	Value		Unit	Notes
			Min	Max		
t1	Power rail rise time, 10% to 90%	Source	0.5	10	ms	-
t2	Delay from LCD,VCCS to black video generation	Sink	0	200	ms	Automatic Black Video generation prevents display noise until valid video data is received from the Source (see Notes:2 and 3 below)
t3	Delay from LCD,VCCS to HPD high	Sink	0	200	ms	Sink AUX Channel must be operational upon HPD high (see Note:4 below)
t4	Delay from HPD high to link training initialization	Source	-	-	ms	Allows for Source to read Link capability and initialize
t5	Link training duration	Source	-	-	ms	Dependant on Source link training protocol
t6	Link idle	Source	-	-	ms	Min accounts for required BS-Idle pattern. Max allows for Source frame synchronization
t7	Delay from valid video data from Source to video on display	Sink	0	50	ms	Max value allows for Sink to validate video data and timing. At the end of T7, Sink will indicate the detection of valid video data by setting the SINK_STATUS bit to logic 1 (DPCD 00205h, bit 0), and Sink will no longer generate automatic Black Video
t8	Delay from valid video data from Source to backlight on	Source	-	-	ms	Source must assure display video is stable
t9	Delay from backlight off to end of valid video data	Source	-	-	ms	Source must assure backlight is no longer illuminated. At the end of T9, Sink will indicate the detection of no valid video data by setting the SINK_STATUS bit to logic 0 (DPCD 00205h, bit 0), and Sink will automatically display Black Video. (See Notes: 2 and 3 below)
t10	Delay from end of valid video data from Source to power off	Source	0	500	ms	Black video will be displayed after receiving idle or off signals from Source
t11	VCCS power rail fall time, 90% to 10%	Source	0.5	10	ms	-
t12	VCCS Power off time	Source	500	-	ms	-
t _A	LED power rail rise time, 10% to 90%	Source	0.5	10	ms	-
t _B	LED power rail fall time, 90% to 10%	Source	0	10	ms	-

t_c	Delay from LED power rising to LED dimming signal	Source	1	-	ms	-
t_D	Delay from LED dimming signal to LED power falling	Source	1	-	ms	-
t_E	Delay from LED dimming signal to LED enable signal	Source	1	-	ms	-
t_F	Delay from LED enable signal to LED dimming signal	Source	1	-	ms	-

Note (1) Please don't plug or unplug the interface cable when system is turned on.

Note (2) The Sink must include the ability to automatically generate Black Video autonomously. The Sink must automatically enable Black Video under the following conditions:

- Upon LCDVCC power-on (within T2 max)
- When the "NoVideoStream_Flag" (VB-ID Bit 3) is received from the Source (at the end of T9)

Note (3) The Sink may implement the ability to disable the automatic Black Video function, as described in Note (2), above, for system development and debugging purposes.

Note (4) The Sink must support AUX Channel polling by the Source immediately following LCDVCC power-on without causing damage to the Sink device (the Source can re-try if the Sink is not ready). The Sink must be able to response to an AUX Channel transaction with the time specified within T3 max.

5. OPTICAL CHARACTERISTICS

5.1 TEST CONDITIONS

Item	Symbol	Value	Unit
Ambient Temperature	T _a	25±2	°C
Ambient Humidity	H _a	50±10	%RH
Supply Voltage	V _{CC}	3.3	V
Input Signal	According to typical value in "3. ELECTRICAL CHARACTERISTICS"		
LED Light Bar Input Current	I _L	69	mA

The measurement methods of optical characteristics are shown in Section 5.2. The following items should be measured under the test conditions described in Section 5.1 and stable environment shown in Note (5).

5.2 OPTICAL SPECIFICATIONS

Item		Symbol	Condition	Min.	Typ.	Max.	Unit	Note	
Contrast Ratio		CR	$\theta_x=0^\circ, \theta_y=0^\circ$ Viewing Normal Angle	500	650	-	-	(2), (5),(7)	
Response Time		T _R		-	3	8	ms	(3),(7)	
		T _F		-	7	12	ms		
Average Luminance of White		L _{Ave}			187	220	-	cd/m ²	(4), (6),(7)
Color Chromaticity	Red	R _x		$\theta_x=0^\circ, \theta_y=0^\circ$ Viewing Normal Angle	Typ - 0.03	0.575	Typ + 0.03	-	(1),(7)
		R _y				0.335		-	
	Green	G _x				0.327		-	
		G _y				0.580		-	
	Blue	B _x				0.157		-	
		B _y				0.137		-	
	White	W _x	0.313			-			
		W _y	0.329			-			
Viewing Angle	Horizontal	θ_{x+}	CR≥10	40	45	-	Deg.	(1),(5), (7)	
		θ_{x-}		40	45	-			
	Vertical	θ_{y+}		15	20	-			
		θ_{y-}		40	45	-			
White Variation of 5 Points		δW_{5p}	$\theta_x=0^\circ, \theta_y=0^\circ$	80	-	-	%	(5),(6), (7)	

PRODUCT SPECIFICATION

Note (1) Definition of Viewing Angle (θ_x, θ_y):

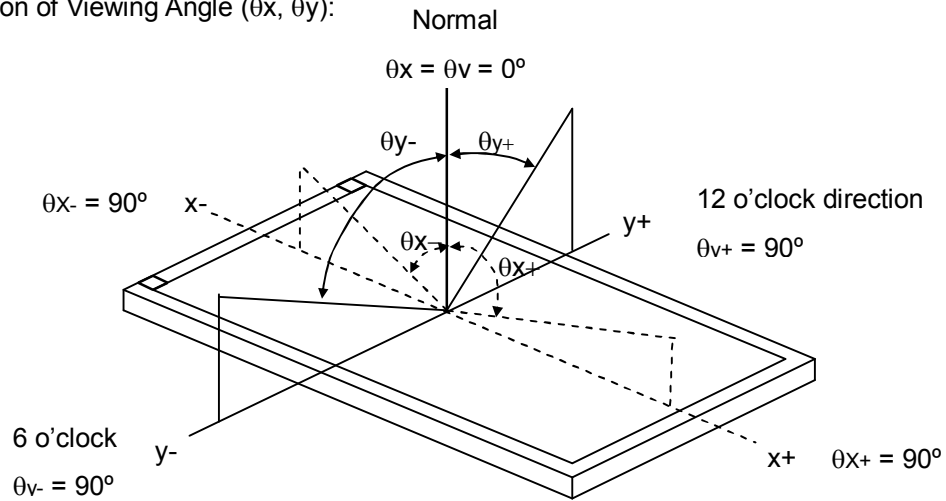

Note (2) Definition of Contrast Ratio (CR):

The contrast ratio can be calculated by the following expression.

$$\text{Contrast Ratio (CR)} = L_{63} / L_0$$

L63: Luminance of gray level 63

L 0: Luminance of gray level 0

$$\text{CR} = \text{CR} (1)$$

CR (X) is corresponding to the Contrast Ratio of the point X at Figure in Note (6).

Note (3) Definition of Response Time (T_R, T_F):

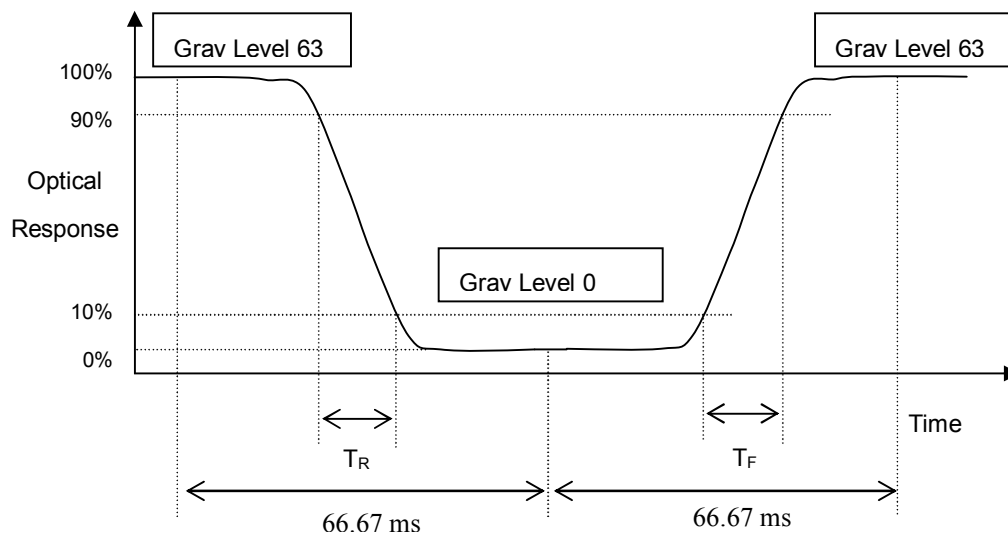

Note (4) Definition of Average Luminance of White (L_{AVE}):

Measure the luminance of White at 5 points

$$L_{AVE} = [L (1)+ L (2)+ L (3)+ L (4)+ L (5)] / 5$$

L (x) is corresponding to the luminance of the point X at Figure in Note (6)

PRODUCT SPECIFICATION

Note (5) Measurement Setup:

The LCD module should be stabilized at given temperature for 20 minutes to avoid abrupt temperature change during measuring. In order to stabilize the luminance, the measurement should be executed after lighting Backlight for 20 minutes in a windless room.

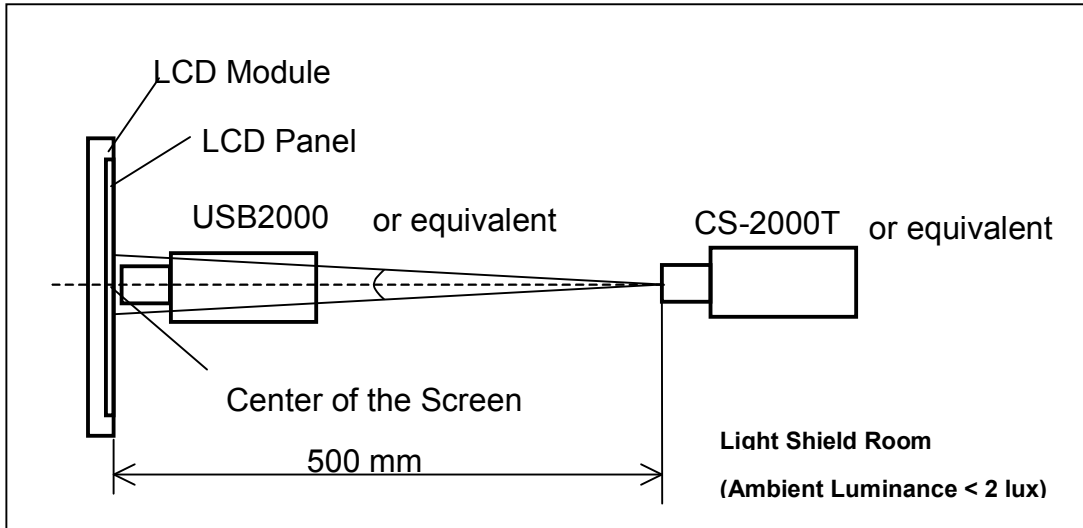

Note (6) Definition of White Variation (δW):

Measure the luminance of White at 5 points

$$\delta W_{5p} = \{ \text{Minimum} [L(1) \sim L(5)] / \text{Maximum} [L(1) \sim L(5)] \} * 100\%$$

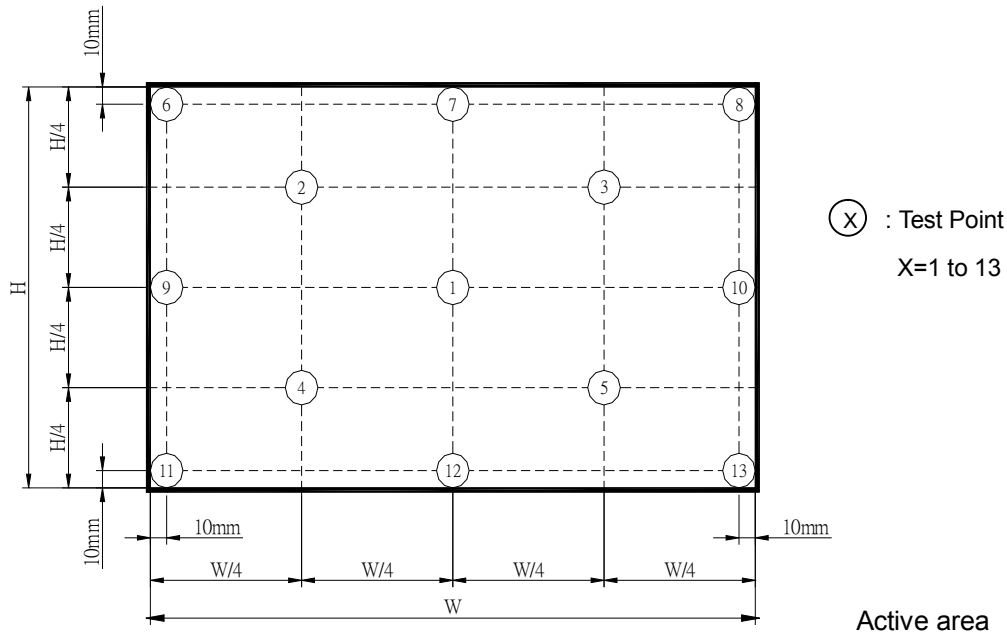

Note (7) The listed optical specifications refer to the initial value of manufacture, but the condition of the specifications after long-term operation will not be warranted.

6. RELIABILITY TEST ITEM

Test Item	Test Condition	Note
High Temperature Storage Test	60°C, 240 hours	(1) (2)
Low Temperature Storage Test	-20°C, 240 hours	
Thermal Shock Storage Test	-20°C, 0.5hour \longleftrightarrow 60°C, 0.5hour; 100cycles, 1hour/cycle	
High Temperature Operation Test	50°C, 240 hours	
Low Temperature Operation Test	0°C, 240 hours	
High Temperature & High Humidity Operation Test	50°C, 80% RH, 240 hours	
ESD Test (Operation)	150pF, 330 Ω , 1sec/cycle Condition 1 : Contact Discharge, \pm 8KV Condition 2 : Air Discharge, \pm 15KV	(1)
Shock (Non-Operating)	220G, 2ms, half sine wave, 1 time for each direction of \pm X, \pm Y, \pm Z	(1)(3)
Vibration (Non-Operating)	1.5G / 10-500 Hz, Sine wave, 30 min/cycle, 1cycle for each X, Y, Z	(1)(3)

Note (1) criteria : Normal display image with no obvious non-uniformity and no line defect.

Note (2) Evaluation should be tested after storage at room temperature for more than two hour

Note (3) At testing Vibration and Shock, the fixture in holding the module has to be hard and rigid enough so that the module would not be twisted or bent by the fixture.

7. PACKING

7.1 MODULE LABEL

The barcode nameplate is pasted on each module as illustration, and its definitions are as following explanation.



- (a) Model Name: N140BGE - E43
- (b) Revision: Rev. XX, for example: C1, C2 ...etc.
- (c) Serial ID: XXXXXXYMDLNNNN

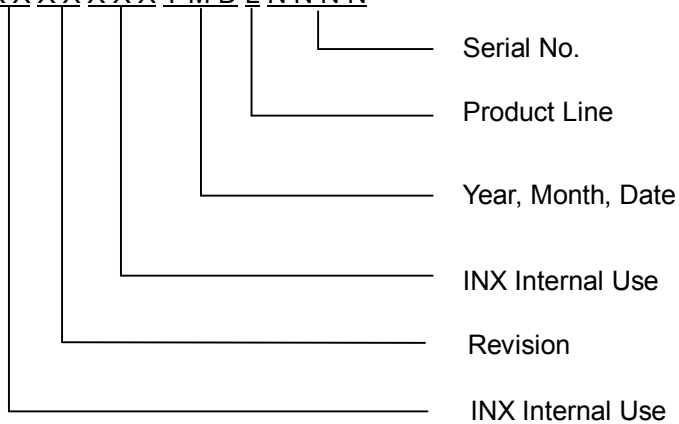

- (d) Production Location: MADE IN XXXX.
- (e) UL/CB logo: XXXX is UL factory ID.

Serial ID includes the information as below:

- (a) Manufactured Date: Year: 0~9, for 2010~2019
 Month: 1~9, A~C, for Jan. ~ Dec.
 Day: 1~9, A~Y, for 1st to 31st, exclude I, O and U
- (b) Revision Code: cover all the change
- (c) Serial No.: Manufacturing sequence of product
- (d) Product Line: 1 -> Line1, 2 -> Line 2, ...etc.

7.2 CARTON

(1) Box Dimensions : 435(L)*350(W)*275(H)
(2) 20 Modules/Carton

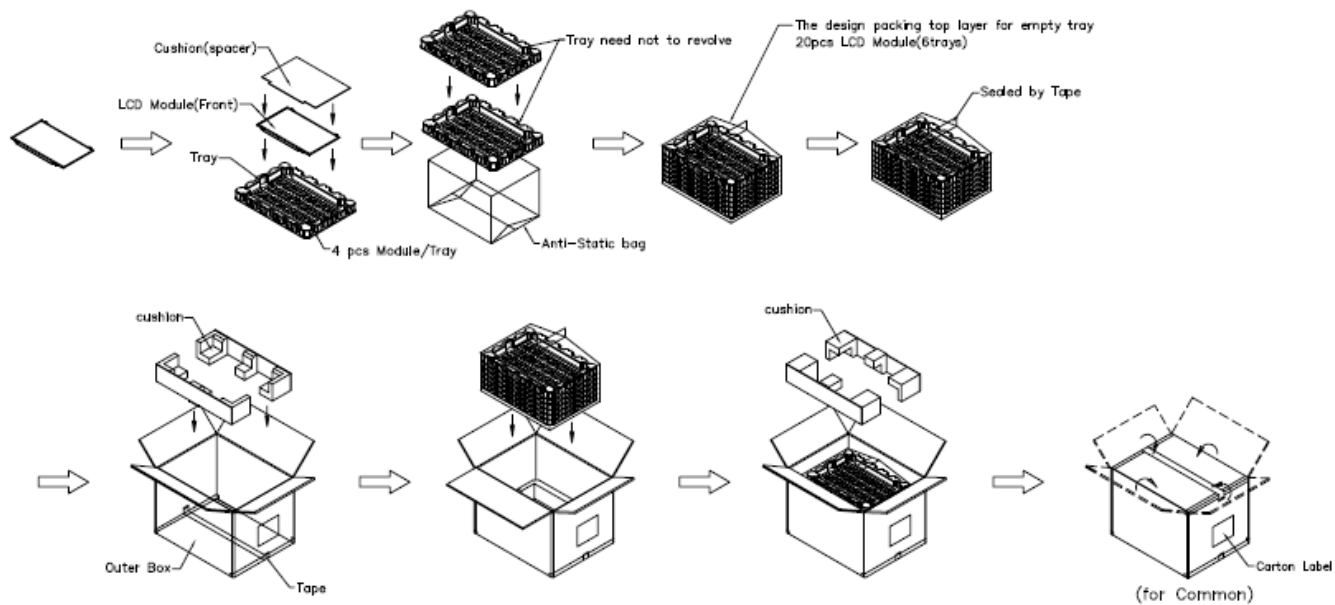

Figure. 7-1 Packing method

7.3 PALLET

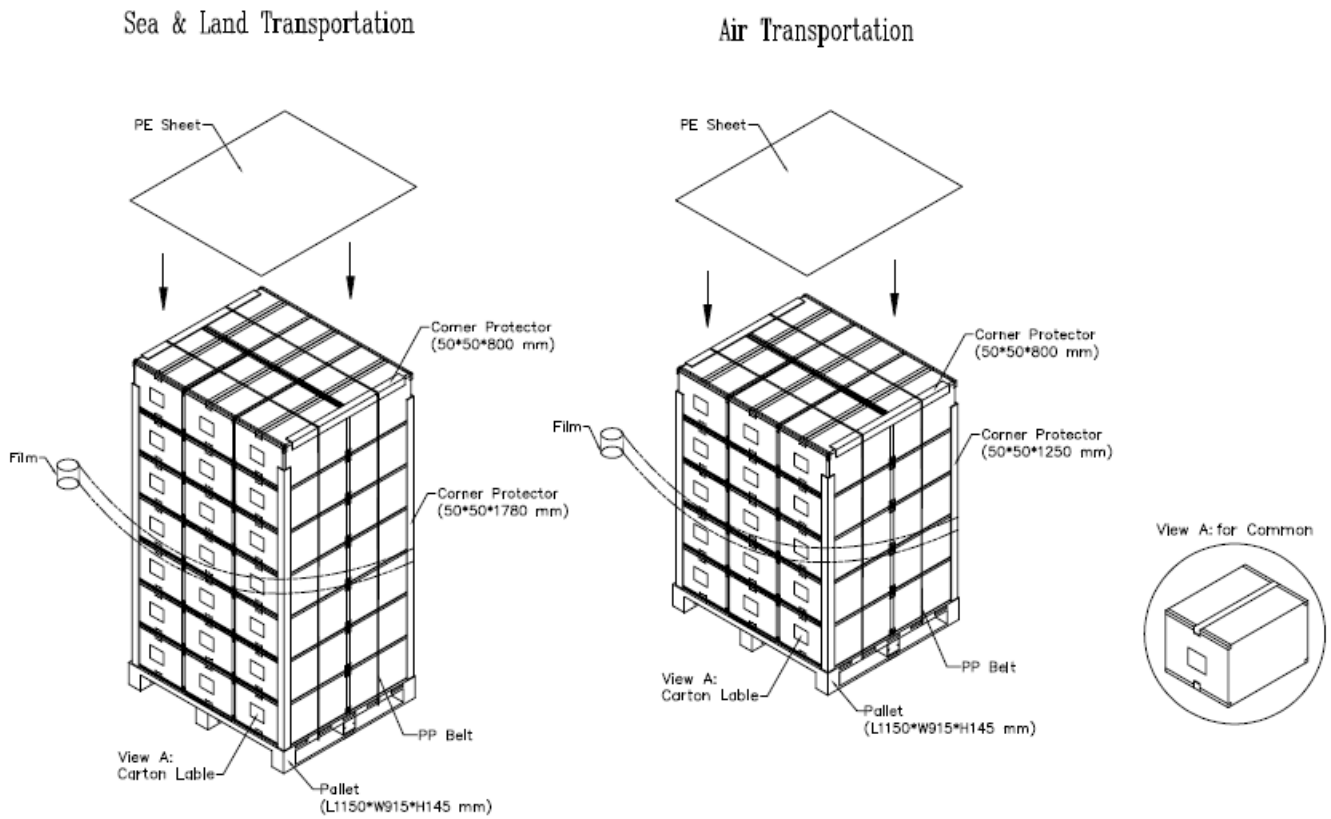

Figure. 7-2 Packing method

7.4 UN-PACKAGING METHOD

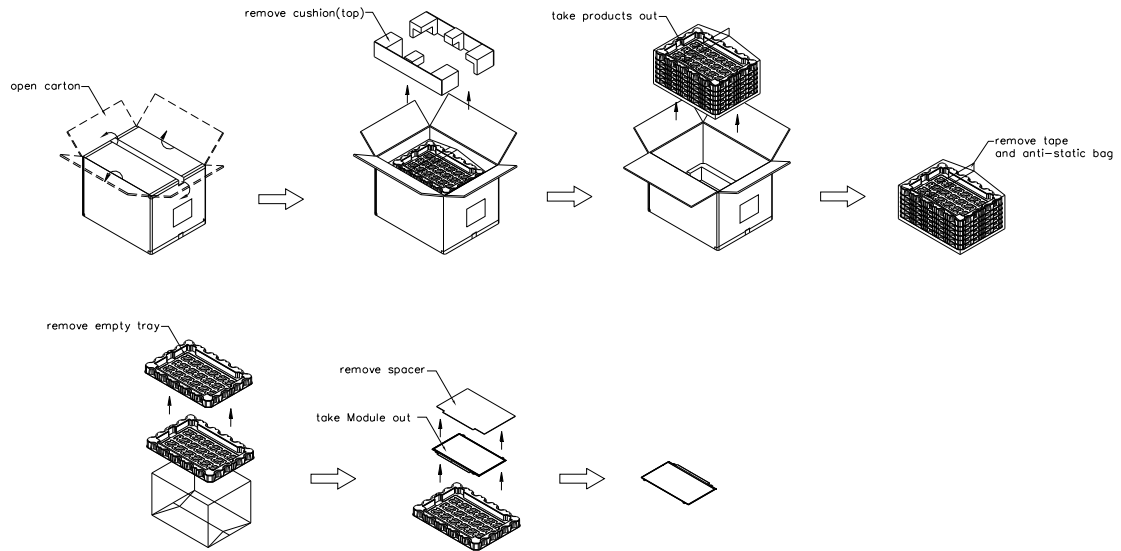

Figure. 7.3 un-packing method

8. PRECAUTIONS**8.1 HANDLING PRECAUTIONS**

- (1) The module should be assembled into the system firmly by using every mounting hole. Be careful not to twist or bend the module.
- (2) While assembling or installing modules, it can only be in the clean area. The dust and oil may cause electrical short or damage the polarizer.
- (3) Use fingerstalls or soft gloves in order to keep display clean during the incoming inspection and assembly process.
- (4) Do not press or scratch the surface harder than a HB pencil lead on the panel because the polarizer is very soft and easily scratched.
- (5) If the surface of the polarizer is dirty, please clean it by some absorbent cotton or soft cloth. Do not use Ketone type materials (ex. Acetone), Ethyl alcohol, Toluene, Ethyl acid or Methyl chloride. It might permanently damage the polarizer due to chemical reaction.
- (6) Wipe off water droplets or oil immediately. Staining and discoloration may occur if they left on panel for a long time.
- (7) If the liquid crystal material leaks from the panel, it should be kept away from the eyes or mouth. In case of contacting with hands, legs or clothes, it must be washed away thoroughly with soap.
- (8) Protect the module from static electricity, it may cause damage to the C-MOS Gate Array IC.
- (9) Do not disassemble the module.
- (10) Do not pull or fold the LED wire.
- (11) Pins of I/F connector should not be touched directly with bare hands.

8.2 STORAGE PRECAUTIONS

- (1) High temperature or humidity may reduce the performance of module. Please store LCD module within the specified storage conditions.
- (2) It is dangerous that moisture come into or contacted the LCD module, because the moisture may damage LCD module when it is operating.
- (3) It may reduce the display quality if the ambient temperature is lower than 10 °C. For example, the response time will become slowly, and the starting voltage of LED will be higher than the room temperature.

8.3 OPERATION PRECAUTIONS

- (1) Do not pull the I/F connector in or out while the module is operating.
- (2) Always follow the correct power on/off sequence when LCD module is connecting and operating. This can prevent the INXS LSI chips from damage during latch-up.
- (3) The startup voltage of Backlight is approximately 1000 Volts. It may cause electrical shock while assembling with converter. Do not disassemble the module or insert anything into the Backlight unit.

Appendix. EDID DATA STRUCTURE

The EDID (Extended Display Identification Data) data formats are to support displays as defined in the VESA Plug & Display and FPD standards.

Byte # (decimal)	Byte # (hex)	Field Name and Comments	Value (hex)	Value (binary)
0	00	Header	00	00000000
1	01	Header	FF	11111111
2	02	Header	FF	11111111
3	03	Header	FF	11111111
4	04	Header	FF	11111111
5	05	Header	FF	11111111
6	06	Header	FF	11111111
7	07	Header	00	00000000
8	08	ID system manufacturer name ("CMN")	0D	00001101
9	09	ID system manufacturer name	AE	10101110
10	0A	ID system Product Code (LSB)	93	10010011
11	0B	ID system Product Code (MSB)	14	00010100
12	0C	ID S/N (fixed "0")	00	00000000
13	0D	ID S/N (fixed "0")	00	00000000
14	0E	ID S/N (fixed "0")	00	00000000
15	0F	ID S/N (fixed "0")	00	00000000
16	10	Week of manufacture ("40")	28	00101000
17	11	Year of manufacture ("2013")	17	00010111
18	12	EDID structure version ("1")	01	00000001
19	13	EDID revision ("4")	04	00000100
20	14	Video I/P definition("Digital")	95	10010101
21	15	Active area horizontal ("30.9399cm")	1F	00011111
22	16	Active area vertical ("17.3952cm")	11	00010001
23	17	Display Gamma (Gamma = "2.2")	78	01111000
24	18	Feature support ("RGB, Non-continuous")	02	00000010
25	19	Rx1, Rx0, Ry1, Ry0, Gx1, Gx0, Gy1, Gy0	7E	01111110
26	1A	Bx1, Bx0, By1, By0, Wx1, Wx0, Wy1, Wy0	45	01000101
27	1B	Rx=0.575	93	10010011
28	1C	Ry=0.335	55	01010101
29	1D	Gx=0.327	53	01010011
30	1E	Gy=0.58	94	10010100
31	1F	Bx=0.157	28	00101000
32	20	By=0.137	23	00100011
33	21	Wx=0.313	50	01010000
34	22	Wy=0.329	54	01010100
35	23	Established timings 1	00	00000000
36	24	Established timings 2	00	00000000
37	25	Manufacturer's reserved timings	00	00000000
38	26	Standard timing ID # 1	01	00000001
39	27	Standard timing ID # 1	01	00000001
40	28	Standard timing ID # 2	01	00000001
41	29	Standard timing ID # 2	01	00000001

PRODUCT SPECIFICATION

42	2A	Standard timing ID # 3	01	00000001
43	2B	Standard timing ID # 3	01	00000001
44	2C	Standard timing ID # 4	01	00000001
45	2D	Standard timing ID # 4	01	00000001
46	2E	Standard timing ID # 5	01	00000001
47	2F	Standard timing ID # 5	01	00000001
48	30	Standard timing ID # 6	01	00000001
49	31	Standard timing ID # 6	01	00000001
50	32	Standard timing ID # 7	01	00000001
51	33	Standard timing ID # 7	01	00000001
52	34	Standard timing ID # 8	01	00000001
53	35	Standard timing ID # 8	01	00000001
54	36	Detailed timing description # 1 Pixel clock ("76.42MHz")	DA	11011010
55	37	# 1 Pixel clock (hex LSB first)	1D	00011101
56	38	# 1 H active ("1366")	56	01010110
57	39	# 1 H blank ("226")	E2	11100010
58	3A	# 1 H active : H blank	50	01010000
59	3B	# 1 V active ("768")	00	00000000
60	3C	# 1 V blank ("32")	20	00100000
61	3D	# 1 V active : V blank	30	00110000
62	3E	# 1 H sync offset ("68")	44	01000100
63	3F	# 1 H sync pulse width ("45")	2D	00101101
64	40	# 1 V sync offset : V sync pulse width ("4 : 7")	47	01000111
65	41	# 1 H sync offset : H sync pulse width : V sync offset : V sync width	00	00000000
66	42	# 1 H image size ("309 mm")	35	00110101
67	43	# 1 V image size ("173 mm")	AD	10101101
68	44	# 1 H image size : V image size	10	00010000
69	45	# 1 H boarder ("0")	00	00000000
70	46	# 1 V boarder ("0")	00	00000000
71	47	# 1 Non-interlaced, Normal, no stereo, Separate sync, H/V pol Negatives	18	00011000
72	48	Detailed timing description # 2	00	00000000
73	49	# 2 Flag	00	00000000
74	4A	# 2 Reserved	00	00000000
75	4B	# 2 ASCII string Model name	FE	11111110
76	4C	# 2 Flag	00	00000000
77	4D	# 2 Character of Model name ("N")	4E	01001110
78	4E	# 2 Character of Model name ("1")	31	00110001
79	4F	# 2 Character of Model name ("4")	34	00110100
80	50	# 2 Character of Model name ("0")	30	00110000
81	51	# 2 Character of Model name ("B")	42	01000010
82	52	# 2 Character of Model name ("G")	47	01000111
83	53	# 2 Character of Model name ("E")	45	01000101
84	54	# 2 Character of Model name ("-")	2D	00101101
85	55	# 2 Character of Model name ("E")	45	01000101
86	56	# 2 Character of Model name ("4")	34	00110100
87	57	# 2 Character of Model name ("3")	33	00110011

PRODUCT SPECIFICATION

88	58	# 2 New line character indicates end of ASCII string	0A	00001010
89	59	# 2 Padding with "Blank" character	20	00100000
90	5A	Detailed timing description # 3	00	00000000
91	5B	# 3 Flag	00	00000000
92	5C	# 3 Reserved	00	00000000
93	5D	# 3 ASCII string Vendor	FE	11111110
94	5E	# 3 Flag	00	00000000
95	5F	# 3 1st character of string ("C")	43	01000011
96	60	# 3 2nd character of string ("M")	4D	01001101
97	61	# 3 3rd character of string ("N")	4E	01001110
98	62	# 3 New line character indicates end of ASCII string	0A	00001010
99	63	# 3 Padding with "Blank" character	20	00100000
100	64	# 3 Padding with "Blank" character	20	00100000
101	65	# 3 Padding with "Blank" character	20	00100000
102	66	# 3 Padding with "Blank" character	20	00100000
103	67	# 3 Padding with "Blank" character	20	00100000
104	68	# 3 Padding with "Blank" character	20	00100000
105	69	# 3 Padding with "Blank" character	20	00100000
106	6A	# 3 Padding with "Blank" character	20	00100000
107	6B	# 3 Padding with "Blank" character	20	00100000
108	6C	Detailed timing description # 4	00	00000000
109	6D	# 4 Flag	00	00000000
110	6E	# 4 Reserved	00	00000000
111	6F	# 4 ASCII string Model Name	FE	11111110
112	70	# 4 Flag	00	00000000
113	71	# 4 Character of Model name ("N")	4E	01001110
114	72	# 4 Character of Model name ("1")	31	00110001
115	73	# 4 Character of Model name ("4")	34	00110100
116	74	# 4 Character of Model name ("0")	30	00110000
117	75	# 4 Character of Model name ("B")	42	01000010
118	76	# 4 Character of Model name ("G")	47	01000111
119	77	# 4 Character of Model name ("E")	45	01000101
120	78	# 4 Character of Model name ("-")	2D	00101101
121	79	# 4 Character of Model name ("E")	45	01000101
122	7A	# 4 Character of Model name ("4")	34	00110100
123	7B	# 4 Character of Model name ("3")	33	00110011
124	7C	# 4 New line character indicates end of ASCII string	0A	00001010
125	7D	# 4 Padding with "Blank" character	20	00100000
126	7E	Extension flag	00	00000000
127	7F	Checksum	95	10010101

Appendix. OUTLINE DRAWING

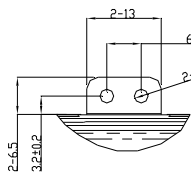
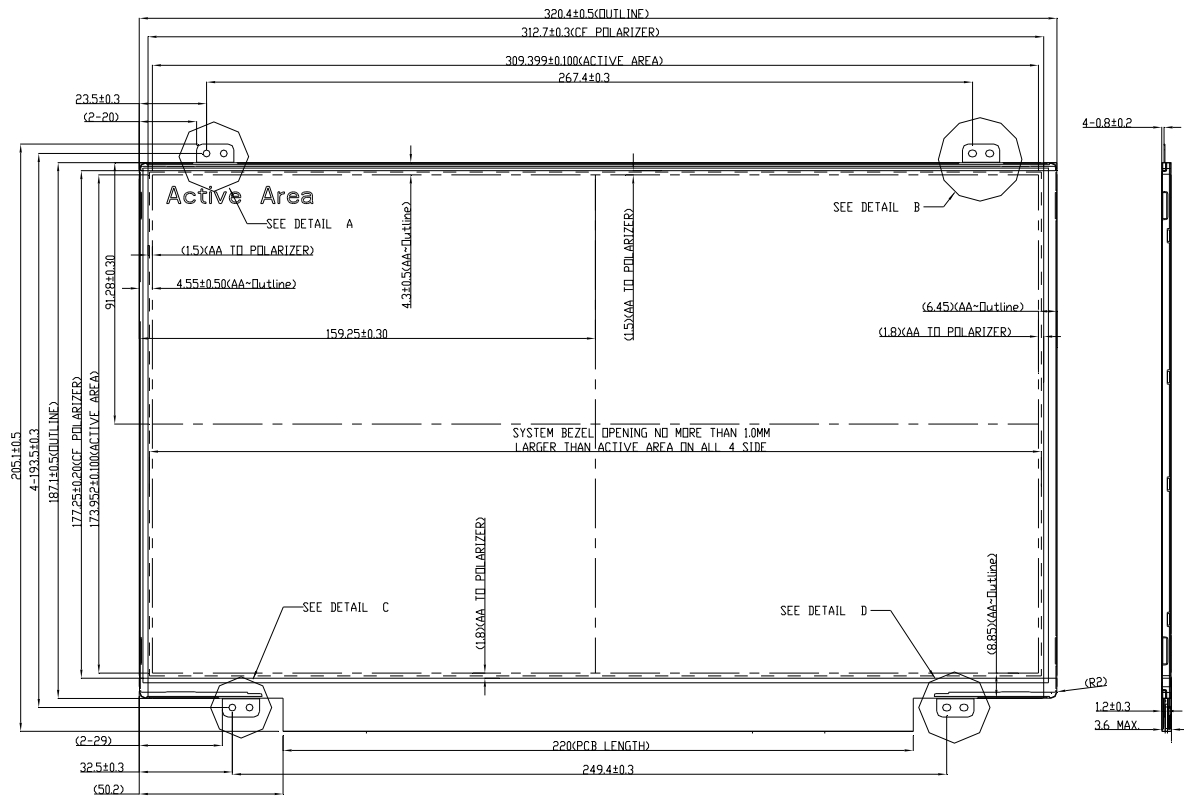

DETAIL A
SCALE 2:1

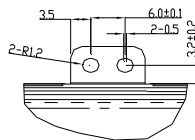

DETAIL B
SCALE 2:1

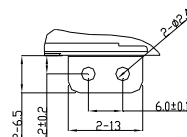

DETAIL C
SCALE 2:1

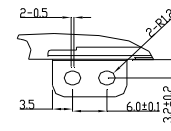

DETAIL D
SCALE 2:1

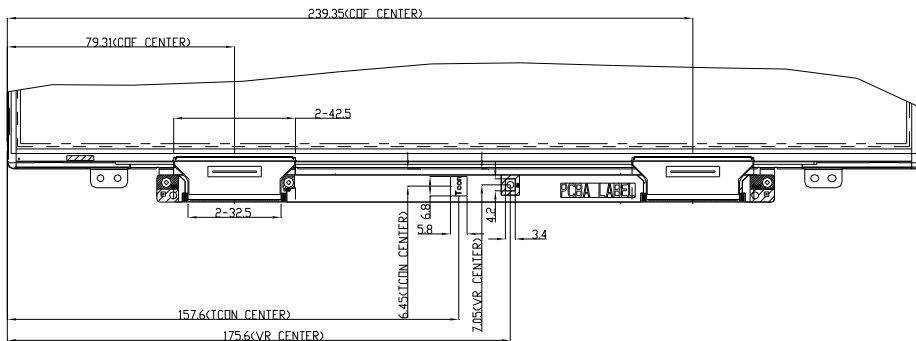

CDF, TCON, AND VR LOCATIONS
SEE NOTES FOR EXPLANATION

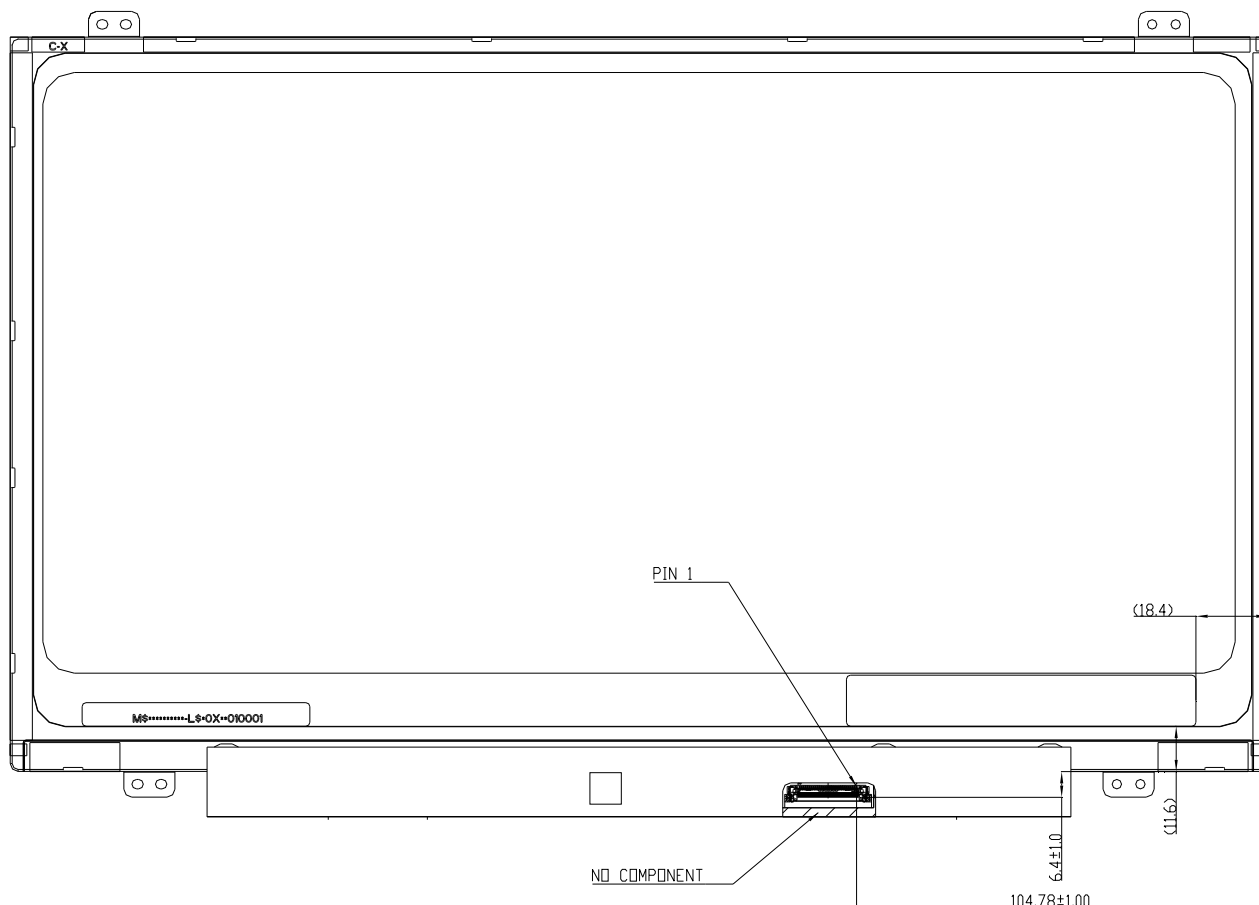

NOTES:

1. LCD MODULE INPUT CONNECTOR : I-PEX 20455-030E-12
2. IN ORDER TO AVOID ABNORMAL DISPLAY, POOLING AND WHITE SPOT,
NO OVERLAPPING IS SUGGESTED AT CABLES, ANTENNAS, CAMERA, WLAN, WAN OR
FOREIGN OBJECTS OVER COF, T-CON AND VR LOCATIONS.
3. EDP CONNECTOR IS MEASURED AT PIN1 AND ITS MATING LINE.
4. MODULE FLATNESS SPEC 0.5mm MAX.
5. '()' MARKS THE REFERENCE DIMENSIONS.

Appendix. SYSTEM COVER DESIGN GUIDANCE

Ver.4

0.	Permanent deformation of system cover after reliability test
Definition	<p>System cover including front and rear cover may deform during reliability test. Permanent deformation of system front and rear cover after reliability test should not interfere with panel. Because it may cause issues such as pooling, abnormal display, white spot, and also cell crack.</p> <p>Note: If the interference can not be avoided, please feel free to contact INX FAE Engineer for collaboration design. We can help to verify and pass risk assessment for customer reference.</p>
1.	Design gap A between panel & any components on system rear-cover
Definition	<p>Gap between panel's maximum thickness boundary & system's inner surface components such as wire, cable, extrusion is needed for preventing from backpack or pogo test fail. Because zero gap or interference may cause stress concentration. Issues such as pooling, abnormal display, white spot, and cell crack may occur.</p> <p>Maximum flatness of panel and system rear-cover should be taken into account for gap design.</p> <p>Note: If the interference can not be avoided, please feel free to contact INX FAE Engineer for collaboration design. We can help to verify and pass risk assessment for customer reference.</p>
2	Design gap B1 & B2 between panel & protrusions

PRODUCT SPECIFICATION

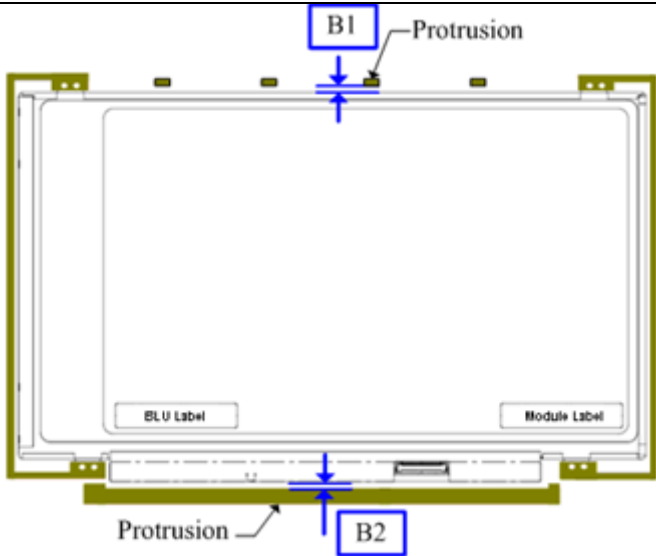
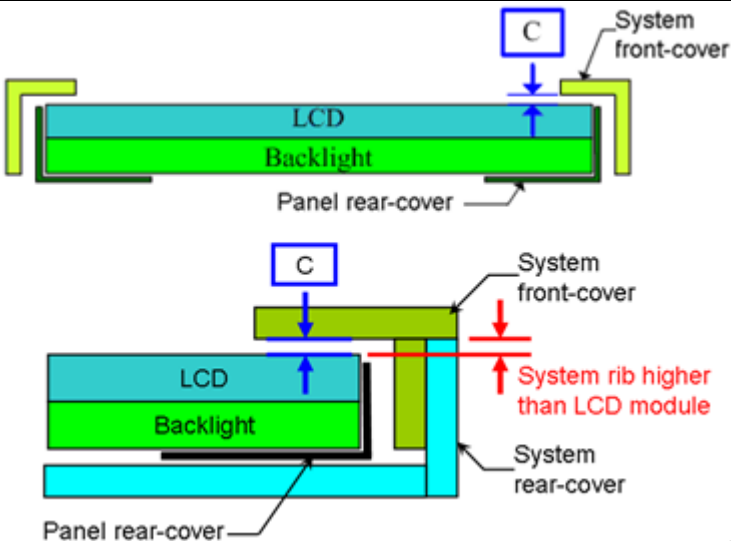
	
<p>Definition</p>	<p>Gap between panel & protrusions is needed to prevent shock test failure. Because protrusions with small gap may hit panel during the test. Issue such as cell crack, abnormal display may occur.</p> <p>The gap should be large enough to absorb the maximum displacement during the test.</p> <p>Note: If the interference can not be avoided, please feel free to contact INX FAE Engineer for collaboration design. We can help to verify and pass risk assessment for customer reference.</p>
<p>3</p>	<p>Design gap C between system front-cover & panel surface.</p>
	
<p>Definition</p>	<p>Gap between system front-cover & panel surface is needed to prevent pooling or glass broken. Zero gap or interference such as burr and warpage from mold frame may cause pooling issue near system front-cover opening edge. This phenomenon is obvious during swing test, hinge test, knock test, or during pooling inspection procedure.</p> <p>To remain sufficient gap, design with system rib higher than maximum panel thickness is recommended.</p> <p>Note: If the interference can not be avoided, please feel free to contact INX FAE Engineer for collaboration design. We can help to verify and pass risk assessment for customer reference.</p>
<p>4</p>	<p>Design gap D1 & D2 between system front-cover & PCB Assembly.</p>

PRODUCT SPECIFICATION

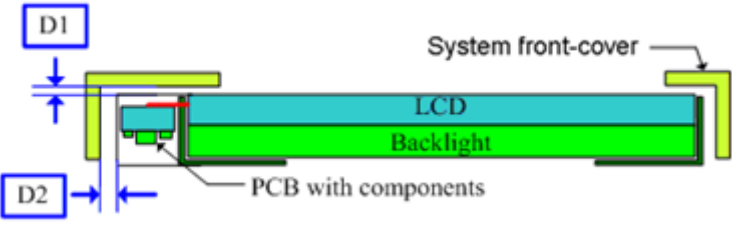
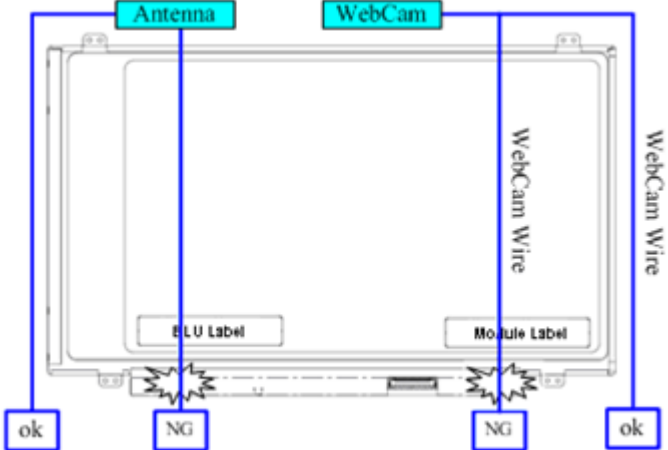
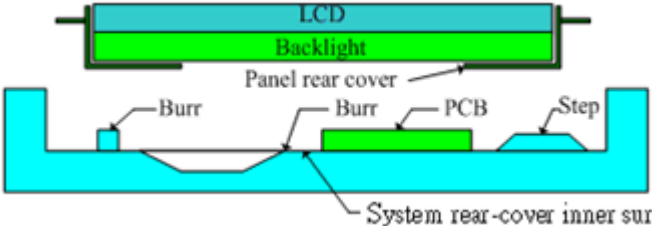
	
Definition	Same as point 2 and 3, but focus on PCBA side.
5	Interference examination of antenna cable and WebCam wire
	
Definition	<p>Antenna cable or WebCam wire should not overlap with panel outline. Because issue such as abnormal display & white spot after backpack test, hinge test, twist test or pogo test may occur.</p> <p>Note: If the interference can not be avoided, please feel free to contact INX FAE Engineer for collaboration design. We can help to verify and pass risk assessment for customer reference.</p>
6	System rear-cover inner surface examination
	
Definition	Burr at logo edge, steps, protrusions or PCB board may cause stress concentration. White spot or glass broken issue may occur during reliability test.
7	Tape/sponge design on system inner surface

PRODUCT SPECIFICATION

<p>Definition</p>	<p>To prevent abnormal display & white spot after scuffing test, hinge test, pogo test, backpack test, tape/sponge should be well covered under panel rear-cover. Because tape/sponge in separate location may act as pressure concentration location.</p>
<p>8</p>	<p>Material used for system rear-cover</p>
<p>Definition</p>	<p>System rear-cover material with high rigidity is needed to resist deformation during scuffing test, hinge test, pogo test, or backpack test. Abnormal display, white spot, pooling issue may occur if low rigidity material is used. Pooling issue may occur because screw's boss positioning for module's bracket are deformed during open-close test. Solid structure design of system rear-cover may also influence the rigidity of system rear-cover. The deformation of system rear-cover should not caused interference.</p>
<p>9</p>	<p>System base unit design near keyboard and mouse pad</p>
<p>Definition</p>	<p>To prevent abnormal display & white spot after scuffing test, hinge test, pogo test, backpack test, sharp edge design in keyboard surface may damage panel during the test. We suggest to use slope edge design, or to reduce the thickness difference of keyboard/mouse pad from the nearby surface.</p>
<p>10</p>	<p>Screw boss height design</p>

PRODUCT SPECIFICATION

	<p>The top diagram shows a cross-section of a panel with LCD and Backlight layers. A screw is being inserted into a screw boss on the system rear-cover. The screw boss is too short, leaving a gap between the screw and the bracket. This is marked with a red 'X' and labeled 'Gap'. The bottom diagram shows a similar setup but with a taller screw boss that fits snugly into the bracket, also marked with a green circle and labeled 'Gap'.</p>
<p>Definition</p>	<p>Screw boss height should be designed with respect to the height of bracket bottom surface to panel bottom surface + flatness change of panel itself. Because gap will exist between screw boss and bracket, if the screw boss height is smaller. As result while fastening screw, bracket will deformed and pooling issue may occur.</p>
<p>11</p>	<p>Assembly SOP examination for system front-cover with Hook design</p>
	<p>The diagram shows a cross-section of the assembly. A hook on the system rear-cover is being pushed into the panel. Assembly pressure is applied from the system front-cover. Red 'X' marks indicate where pressure should not be applied directly to the panel. Green circles indicate where pressure should be applied to the front-cover.</p>
<p>Definition</p>	<p>To prevent panel crack during system front-cover assembly process with hook design, it is not recommended to press panel or any location that related directly to the panel.</p>
<p>12</p>	<p>Assembly SOP examination for system front-cover with Double tape design</p>
	<p>The diagram shows a cross-section of the assembly. The LCD and Backlight panel is placed on a flat surface stage. Assembly force is applied from the system front-cover through the double tape.</p>
<p>Definition</p>	<p>To prevent panel crack during system front-cover assembly process with double tape design, it is only allowed to give slight pressure (MAX 3 Kgf/50mm²) with large contact area. This can help to distribute the stress and prevent stress concentration. We also suggest putting the system on a flat surface stage to prevent unequal stress distribution during the assembly.</p>
<p>13</p>	<p>System front-cover assembly reference with Double tape design</p>

PRODUCT SPECIFICATION

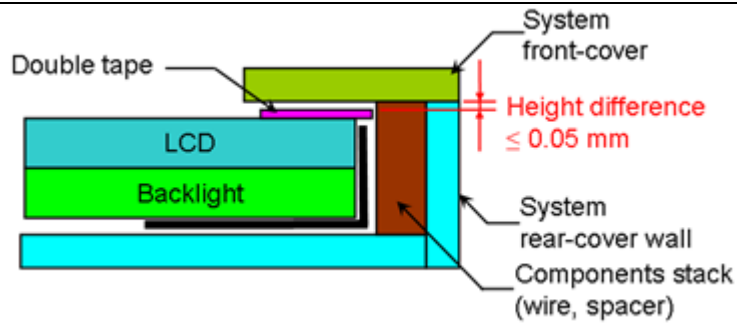

Definition To prevent system front-cover peeling at double tape contact area, Height difference between system front-cover assembly reference such as wall or components stack (wire, spacer) and double tape top surface must be less than 0.05mm.

14 Touch Application : TP and LCD Module Combination for White Line Prevention

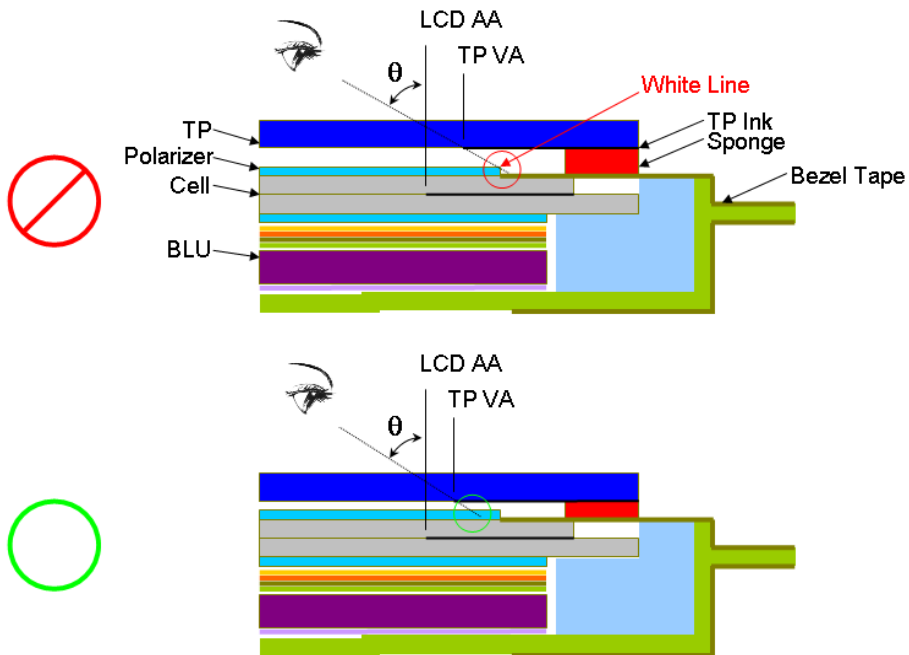

Parameter consideration for White Line Issue :

1	TP VA to LCD AA distance
2	TP Assembly tolerance
3	TP Ink Printing tolerance
4	Sponge thickness and tolerance
5	Inspection/Viewing Angle specification
6	Polarizer edge to LCD AA distance and tolerance

Polarizer edge to LCD AA distance can be derived by "AA~Outline" – "CF Pol~Outline" with respect to INX 2D Outline Drawing on each side.



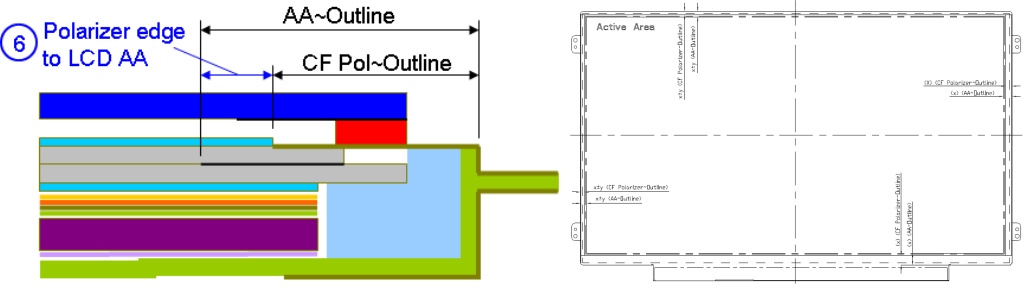
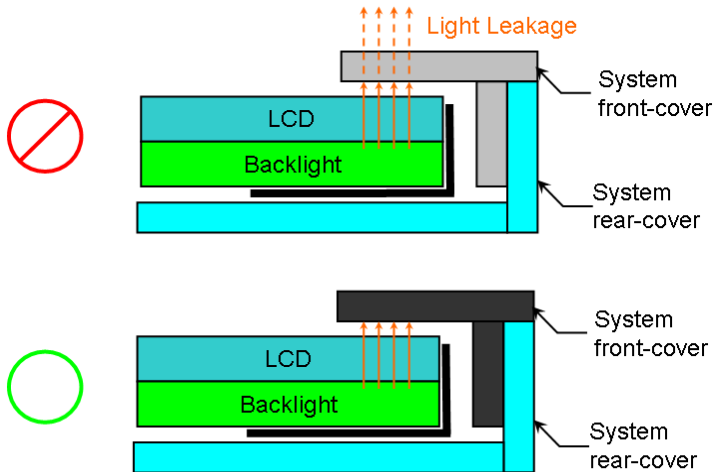

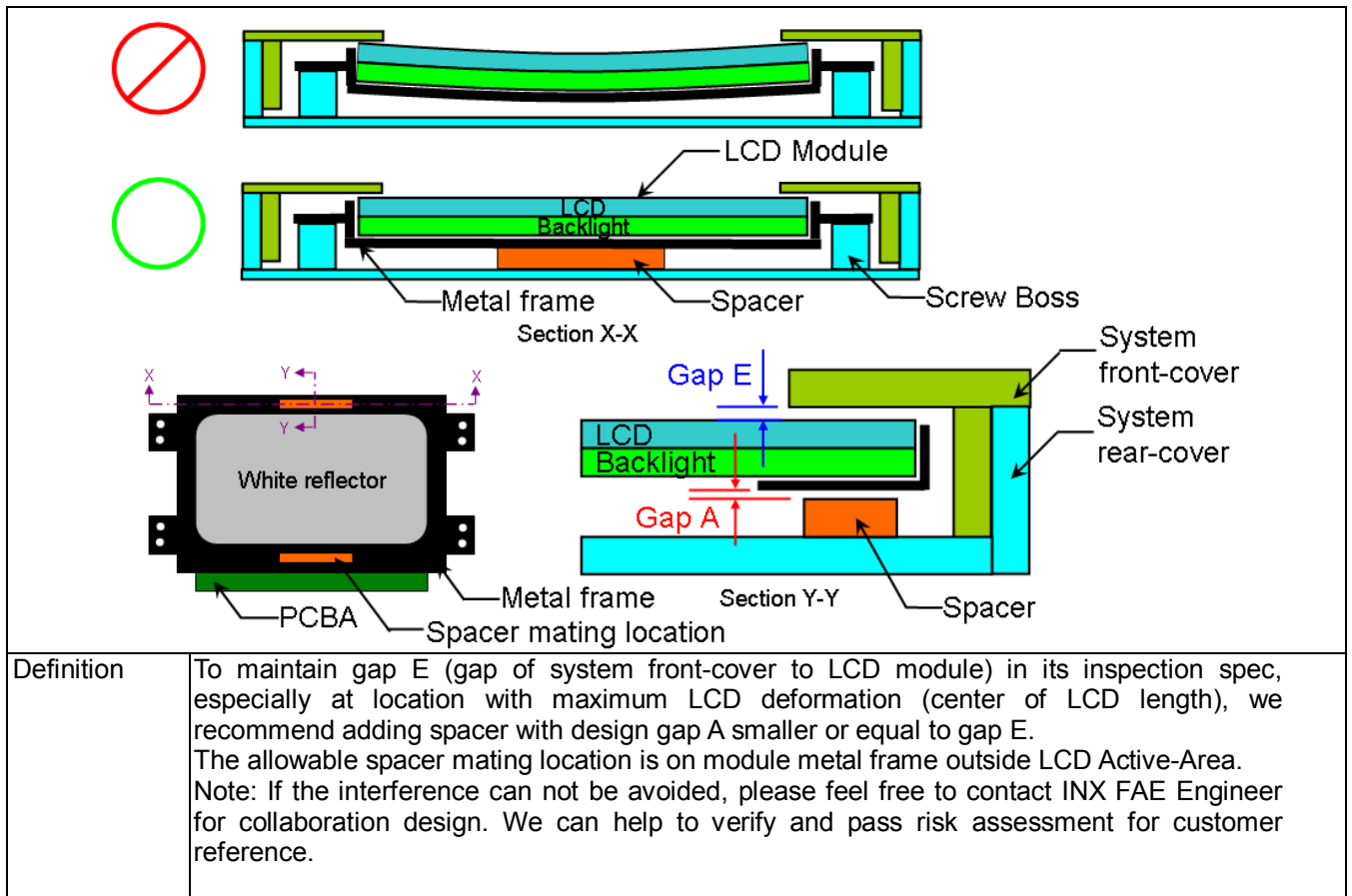

PRODUCT SPECIFICATION

	
<p>Definition</p>	<p>For using in Touch Application: to prevent White Line appears between TP and LCD module combination, the maximum inspection angle location must not fall onto LCD polarizer edge, otherwise light line near edge of polarizer will be appear.</p> <p>Parameters such as TP VA to LCD AA distance, TP assembly tolerance, TP Ink printing tolerance, Sponge thickness and tolerance, and Maximum Inspection/Viewing Angle, must be considered with respect to LCD module's Polarizer edge location and tolerance. This consideration must be taken at all four edges separately.</p> <p>The goal is to find parameters combination that allow maximum inspection angle falls inside polarizer black margin area.</p> <p>Note: Information for Polarizer edge location and its tolerance can be derived from INX 2D Outline Drawing ("AA ~Outline" - "CF Pol~Outline").</p> <p>Note: Please feel free to contact INX FAE Engineer. By providing value of parameters above on each side, we can help to verify and pass the white line risk assessment for customer reference.</p>
<p>15</p>	<p>Color of system front-cover material</p>
	
<p>Definition</p>	<p>To prevent light leakage is seen at system front-cover due to material transparency, we suggest using dark color material (black) for system front-cover design.</p>
<p>16</p>	<p>Inspection spec of gap E between system front-cover to LCD module surface</p>



PRODUCT SPECIFICATION



Appendix. LCD MODULE HANDLING MANUAL

Purpose	<ul style="list-style-type: none"> • This SOP is prepared to prevent panel dysfunction possibility through incorrect handling procedure. • This manual provides guide in unpacking and handling steps. • Any person which may contact / related with panel, should follow guide stated in this manual to prevent panel loss.
1.	Unpacking
<div style="display: flex; justify-content: space-around; align-items: center;"> <div style="text-align: center;">  </div> <div style="text-align: center;"> <p>Open carton</p>  </div> <div style="text-align: center;"> <p>Remove EPE Cushion</p>  </div> </div> <div style="text-align: center; margin: 10px 0;">↓</div> <div style="display: flex; justify-content: space-around; align-items: center;"> <div style="text-align: center;">  </div> <div style="text-align: center;"> <p>Cut Adhesive Tape</p>  </div> <div style="text-align: center;"> <p>Remove EPE Cushion</p>  </div> </div> <div style="display: flex; justify-content: space-around; align-items: center; margin-top: 10px;"> <div style="text-align: center;"> <p>Open plastic bag</p> </div> </div>	
2.	Panel Lifting

PRODUCT SPECIFICATION

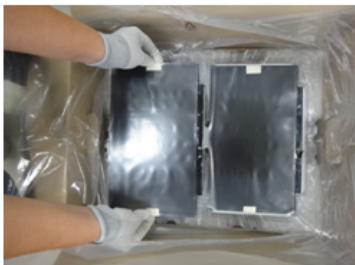
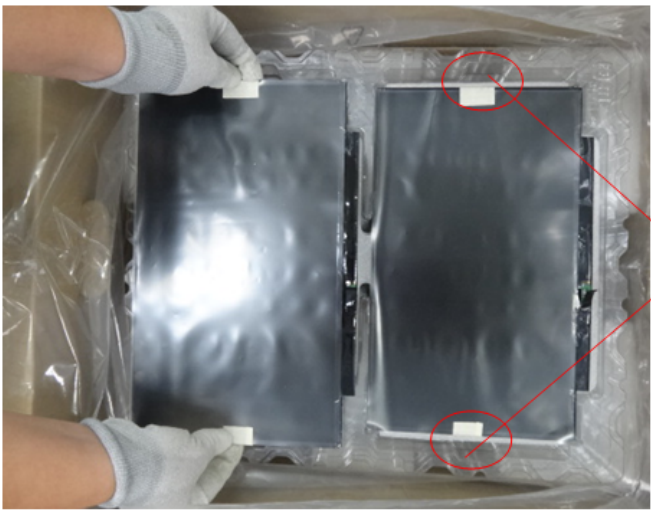
Remove PET Cover	Remove PE Foam	Handle with care (see next page)
		
		
<p>Finger Slot</p> <p>Use slots at both sides for finger insertion. Handle panel upward with care.</p>		
3.	Do and Don't	

PRODUCT SPECIFICATION

Do :

- Handle with both hands.
- Handle panel at left and right edge.



Don't :

- Lifting with one hand.



- Handle at PCBA side.



Don't :

- Stack panels.



- Press panel.



Don't :

- Put foreign stuff onto panel



- Put foreign stuff under panel



Don't :

- Paste any material unto white reflector sheet



Don't :

- Pull / Push white reflector sheet

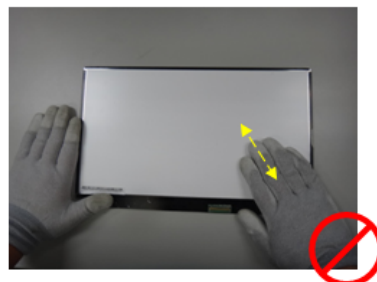

Don't :

- Hold at panel corner.



Don't :

- Twist panel.



Do :

- Hold panel at top edge while inserting connector.



Don't :

- Press white reflector sheet while inserting connector.



Do :

- Remove panel protector film starts from side tape.



Don't :

- Remove panel protector film from film corner directly before side tape is removed.

