

Phase Control Thyristor

Types N3839TC300 to N3839TC350

Old Type No.: N1663CH30-35

Absolute Maximum Ratings

	VOLTAGE RATINGS	MAXIMUM LIMITS	UNITS
V _{DRM}	Repetitive peak off-state voltage, (note 1)	3000-3500	V
V _{DSM}	Non-repetitive peak off-state voltage, (note 1)	3000-3500	V
V _{RRM}	Repetitive peak reverse voltage, (note 1)	3000-3500	V
V _{RSM}	Non-repetitive peak reverse voltage, (note 1)	3100-3600	V

	OTHER RATINGS	MAXIMUM LIMITS	UNITS
I _{T(AV)M}	Maximum average on-state current, T _{sink} =55°C, (note 2)	3839	A
I _{T(AV)M}	Maximum average on-state current. T _{sink} =85°C, (note 2)	2668	A
I _{T(AV)M}	Maximum average on-state current. T _{sink} =85°C, (note 3)	1644	A
I _{T(RMS)M}	Nominal RMS on-state current, T _{sink} =25°C, (note 2)	7527	A
I _{T(d.c.)}	D.C. on-state current, T _{sink} =25°C, (note 4)	6647	A
I _{TSM}	Peak non-repetitive surge t _p =10ms, V _{rm} =60%V _{RRM} , (note 5)	49.5	kA
I _{TSM2}	Peak non-repetitive surge t _p =10ms, V _{rm} ≤10V, (note 5)	55.0	kA
I ² t	I ² t capacity for fusing t _p =10ms, V _{rm} =60%V _{RRM} , (note 5)	12.25×10 ⁶	A ² s
I ² t	I ² t capacity for fusing t _p =10ms, V _{rm} ≤10V, (note 5)	15.13×10 ⁶	A ² s
(di/dt) _{cr}	Critical rate of rise of on-state current (continuous, 50Hz), (Note 6)	75	A/μs
	Critical rate of rise of on-state current (repetitive, 50Hz, 60s), (Note 6)	150	A/μs
	Critical rate of rise of on-state current (non-repetitive), (Note 6)	300	A/μs
V _{RGM}	Peak reverse gate voltage	5	V
P _{G(AV)}	Mean forward gate power	5	W
P _{GM}	Peak forward gate power	50	W
T _{j op}	Operating temperature range	-40 to +125	°C
T _{stg}	Storage temperature range	-40 to +150	°C

Notes:-

- 1) De-rating factor of 0.13% per °C is applicable for T_j below 25°C.
- 2) Double side cooled, single phase; 50Hz, 180° half-sinewave.
- 3) Single side cooled, single phase; 50Hz, 180° half-sinewave.
- 4) Double side cooled.
- 5) Half-sinewave, 125°C T_j initial.
- 6) V_D=67% V_{DRM}, I_{GM}=4A, t_r≤0.5μs, T_{case}=125°C.

Characteristics

	PARAMETER	MIN.	TYP.	MAX.	TEST CONDITIONS (Note 1)	UNITS
V_{TM}	Maximum peak on-state voltage	-	-	1.74 2.51	$I_{TM}=6000A$ $I_{TM}=11500A$	V
V_{T0}	Threshold voltage	-	-	0.95		V
r_T	Slope resistance	-	-	0.14		m Ω
$(dv/dt)_{cr}$	Critical rate of rise of off-state voltage	1000	-	-	$V_D=80\% V_{DRM}$, linear ramp, gate o/c	V/ μs
I_{DRM}	Peak off-state current	-	-	250	Rated V_{DRM}	mA
I_{RRM}	Peak reverse current	-	-	250	Rated V_{RRM}	mA
V_{GT}	Gate trigger voltage	-	-	3.0	$T_j=25^\circ C$ $V_D=10V$, $I_T=3A$	V
I_{GT}	Gate trigger current	-	-	300		mA
V_{GD}	Gate non-trigger voltage	-	-	0.25		Rated V_{DRM}
I_H	Holding current	-	-	1000	$T_j=25^\circ C$	mA
t_{gd}	Gate-controlled turn-on delay time	-	1.0	1.5	$V_D=67\% V_{DRM}$, $I_T=6000A$, $di/dt=10A/\mu s$, $I_{FG}=2A$, $t_r=0.5\mu s$, $T_j=25^\circ C$	μs
t_{gt}	Turn-on time	-	3.0	4.0		μs
Q_{rr}	Recovered charge	-	13000	-	$I_{TM}=4000A$, $t_p=2000\mu s$, $di/dt=10A/\mu s$, $V_r=100V$	μC
Q_{ra}	Recovered charge, 50% Chord	-	7800	8500		μC
I_{rr}	Reverse recovery current	-	280	-		A
t_{rr}	Reverse recovery time	-	55	-		μs
t_q	Turn-off time	-	600	-	$I_{TM}=4000A$, $t_p=2000\mu s$, $di/dt=10A/\mu s$, $V_r=100V$, $V_{dr}=80\%V_{DRM}$, $dV_{dr}/dt=20V/\mu s$	μs
		-	1100	-	$I_{TM}=4000A$, $t_p=2000\mu s$, $di/dt=10A/\mu s$, $V_r=100V$, $V_{dr}=80\%V_{DRM}$, $dV_{dr}/dt=200V/\mu s$	
R_{thJK}	Thermal resistance, junction to heatsink	-	-	0.008	Double side cooled	K/W
		-	-	0.016	Single side cooled	K/W
F	Mounting force	63	-	77		kN
W_t	Weight	-	1.23	-		kg

Notes:-

 1) Unless otherwise indicated $T_j=125^\circ C$.

Notes on Ratings and Characteristics

1.0 Voltage Grade Table

Voltage Grade	V_{DRM} V_{DSM} V_{RRM} V	V_{RSM} V	V_D V_R DC V
30	3000	3100	1800
32	3200	3300	1920
34	3400	3500	2040
35	3500	3600	2100

2.0 Extension of Voltage Grades

This report is applicable to other voltage grades when supply has been agreed by Sales/Production.

3.0 De-rating Factor

A blocking voltage de-rating factor of 0.13%/°C is applicable to this device for T_j below 25°C.

4.0 Repetitive dv/dt

Standard dv/dt is 1000V/μs.

5.0 Snubber Components

When selecting snubber components, care must be taken not to use excessively large values of snubber capacitor or excessively small values of snubber resistor. Such excessive component values may lead to device damage due to the large resultant values of snubber discharge current. If required, please consult the factory for assistance.

6.0 Rate of rise of on-state current

The maximum un-primed rate of rise of on-state current must not exceed 300A/μs at any time during turn-on on a non-repetitive basis. For repetitive performance (1 min), the on-state rate of rise of current must not exceed 150A/μs at any time during turn-on. Note that these values of rate of rise of current apply to the total device current including that from any local snubber network.

7.0 Gate Drive

The nominal requirement for a typical gate drive is illustrated below. An open circuit voltage of at least 30V is assumed. This gate drive must be applied when using the full di/dt capability of the device.

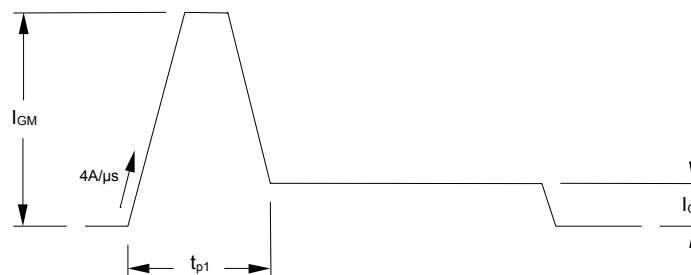

The magnitude of I_{GM} should be between five and ten times I_{GT} , which is shown on page 2. Its duration (t_{p1}) should be 20μs or sufficient to allow the anode current to reach ten times I_L , whichever is greater. Otherwise, an increase in pulse current could be needed to supply the necessary charge to trigger. The 'back-porch' current I_G should remain flowing for the same duration as the anode current and have a magnitude in the order of 1.5 times I_{GT} .

8.0 Computer Modelling Parameters

8.1 Device Dissipation Calculations

$$I_{AV} = \frac{-V_0 + \sqrt{V_0^2 + 4 \cdot ff^2 \cdot r_s \cdot W_{AV}}}{2 \cdot ff^2 \cdot r_s} \quad \text{and:} \quad W_{AV} = \frac{\Delta T}{R_{th}}$$

$$\Delta T = T_{j \max} - T_{Hs}$$

Where $V_0=0.95V$, $r_s=0.14m\Omega$,

R_{th} = Supplementary thermal impedance, see table below and

ff = Form factor, see table below.

Supplementary Thermal Impedance							
Conduction Angle	30°	60°	90°	120°	180°	270°	d.c.
Square wave Double Side Cooled	0.00915	0.00907	0.00898	0.00891	0.00878	0.00864	0.008
Square wave Single Side Cooled	0.01795	0.01781	0.01772	0.01759	0.01731	0.01678	0.016
Sine wave Double Side Cooled	0.00911	0.00903	0.00895	0.00884	0.00867		
Sine wave Single Side Cooled	0.01784	0.01775	0.01763	0.01735	0.01682		

Form Factors							
Conduction Angle	30°	60°	90°	120°	180°	270°	d.c.
Square wave	3.464	2.449	2	1.732	1.414	1.149	1
Sine wave	3.98	2.778	2.22	1.879	1.57		

8.2 Calculating V_T using ABCD Coefficients

The on-state characteristic I_T vs. V_T , on page 6 is represented in two ways;

- (i) the well established V_0 and r_T tangent used for rating purposes and
- (ii) a set of constants A, B, C, D, forming the coefficients of the representative equation for V_T in terms of I_T given below:

$$V_T = A + B \cdot \ln(I_T) + C \cdot I_T + D \cdot \sqrt{I_T}$$

The constants, derived by curve fitting software, are given below for both hot and cold characteristics. The resulting values for V_T agree with the true device characteristic over a current range, which is limited to that plotted.

25°C Coefficients		125°C Coefficients	
A	1.1	A	0.9
B	-2.18×10^{-13}	B	1.07×10^{-13}
C	9.00×10^{-5}	C	1.40×10^{-4}
D	2.47×10^{-14}	D	-1.04×10^{-14}

8.3 D.C. Thermal Impedance Calculation

$$r_t = \sum_{p=1}^{p=n} r_p \cdot \left(1 - e^{-\frac{t}{\tau_p}} \right)$$

Where $p = 1$ to n , n is the number of terms in the series and:

- t = Duration of heating pulse in seconds.
- r_t = Thermal resistance at time t .
- r_p = Amplitude of p_{th} term.
- τ_p = Time Constant of r_{th} term.

The coefficients for this device are shown in the tables below:

D.C. Double Side Cooled			
Term	1	2	3
r_p	4.293445×10^{-3}	2.542182×10^{-3}	1.167986×10^{-3}
τ_p	0.8365194	0.176198	0.02000819

D.C. Single Side Cooled				
Term	1	2	3	4
r_p	9.899658×10^{-3}	2.731068×10^{-3}	2.619106×10^{-3}	1.049687×10^{-3}
τ_p	5.623142	1.132481	0.1461472	0.01849926

9.0 Reverse recovery ratings

(i) Q_{ra} is based on 50% I_{rm} chord as shown in Fig. 1

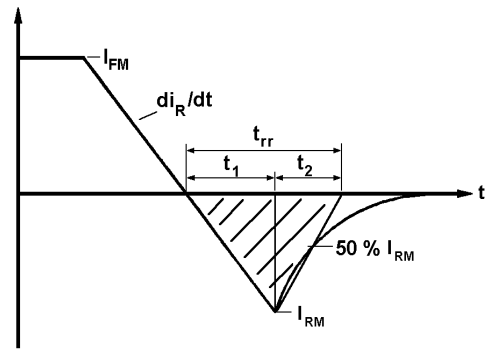

Fig. 1

(ii) Q_{rr} is based on a $150\mu s$ integration time i.e.

$$Q_{rr} = \int_0^{150\mu s} i_{rr} \cdot dt$$

(iii)

$$K \text{ Factor} = \frac{t_1}{t_2}$$

Curves

Figure 1 - On-state characteristics of Limit device

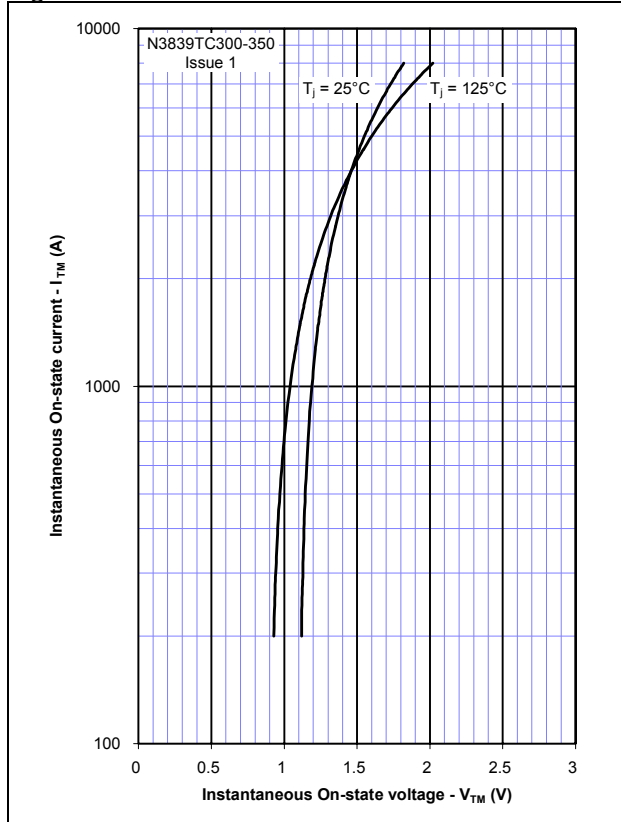

Figure 2 - Transient thermal impedance

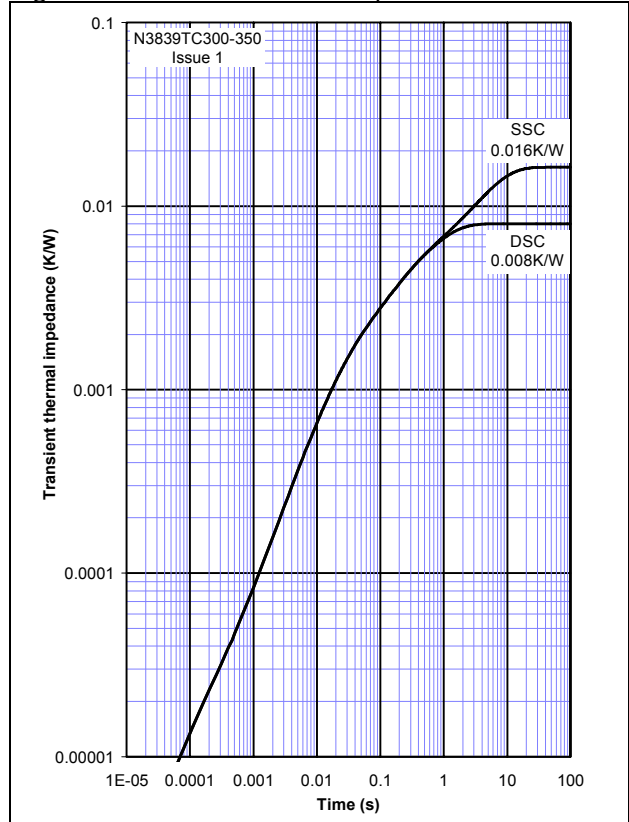

Figure 3 - Gate characteristics - Trigger limits

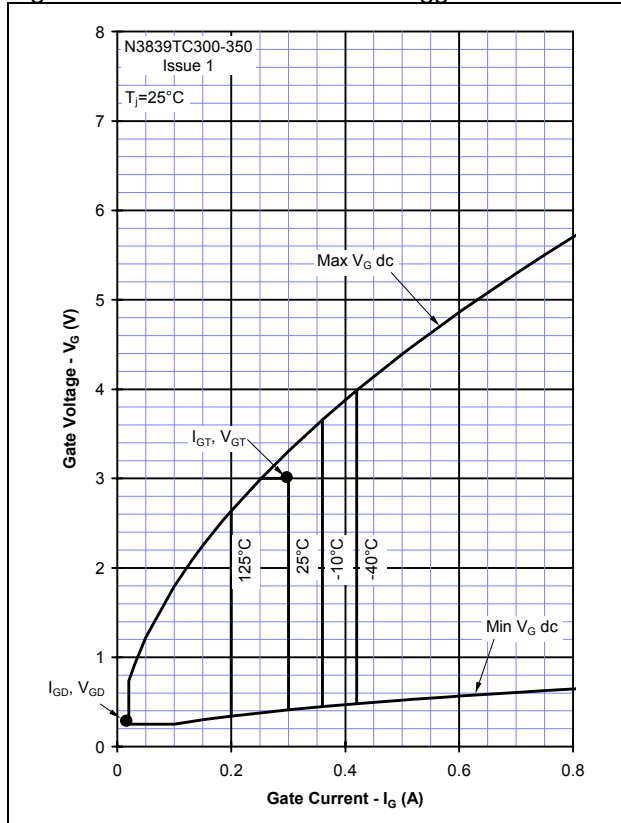

Figure 4 - Gate characteristics - Power curves

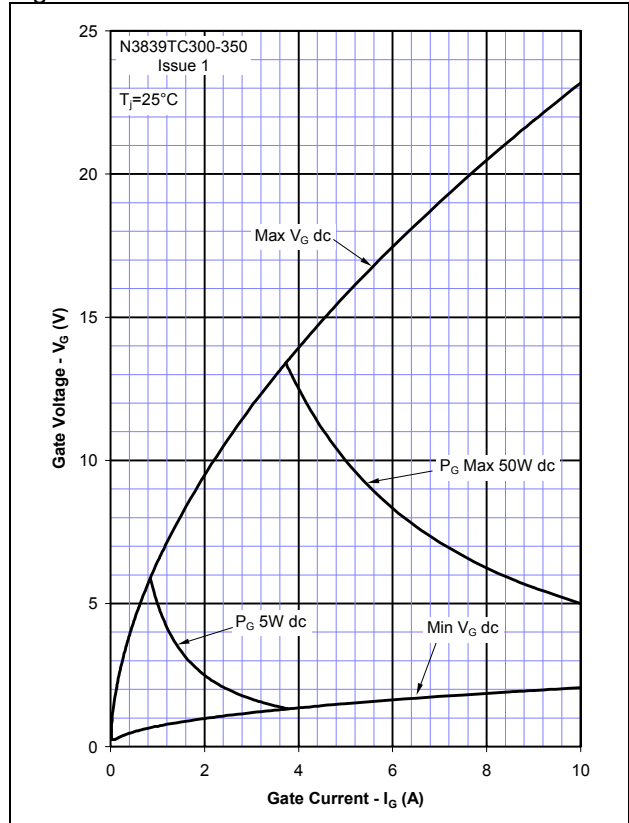

Figure 5 - Total recovered charge, Q_{rr}

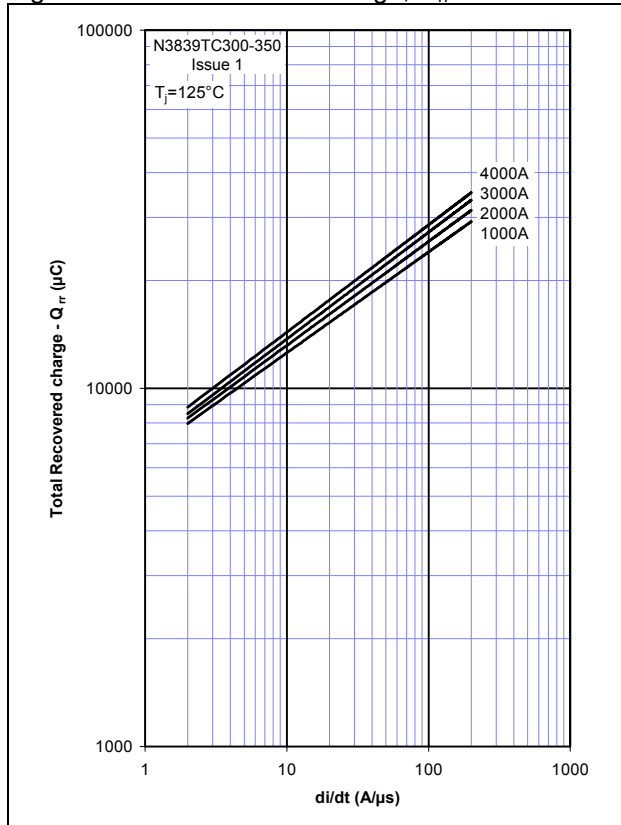

Figure 6 - Recovered charge, Q_{ra} (50% chord)

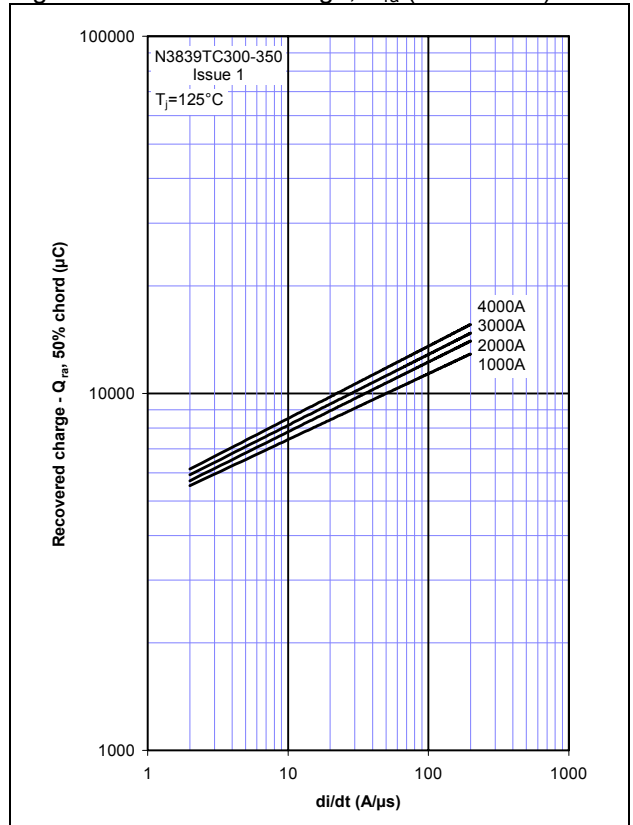

Figure 7 - Peak reverse recovery current, I_{rm}

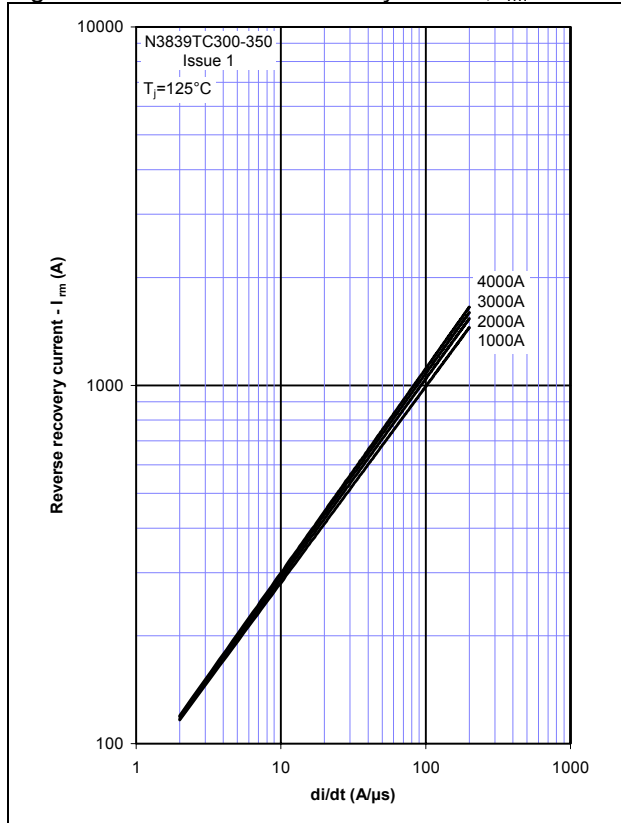

Figure 8 - Maximum recovery time, t_{rr} (50% chord)

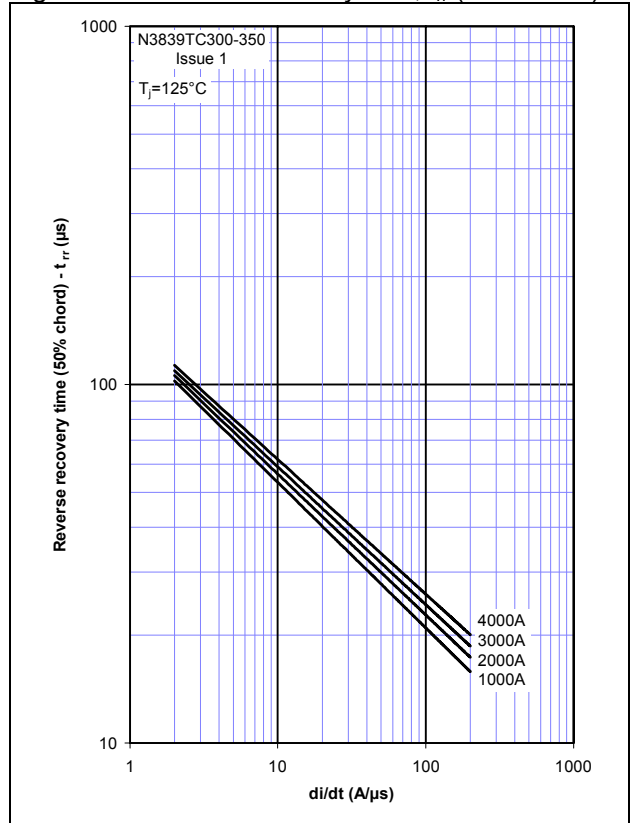

Figure 9 – On-state current vs. Power dissipation – Double Side Cooled (Sine wave)

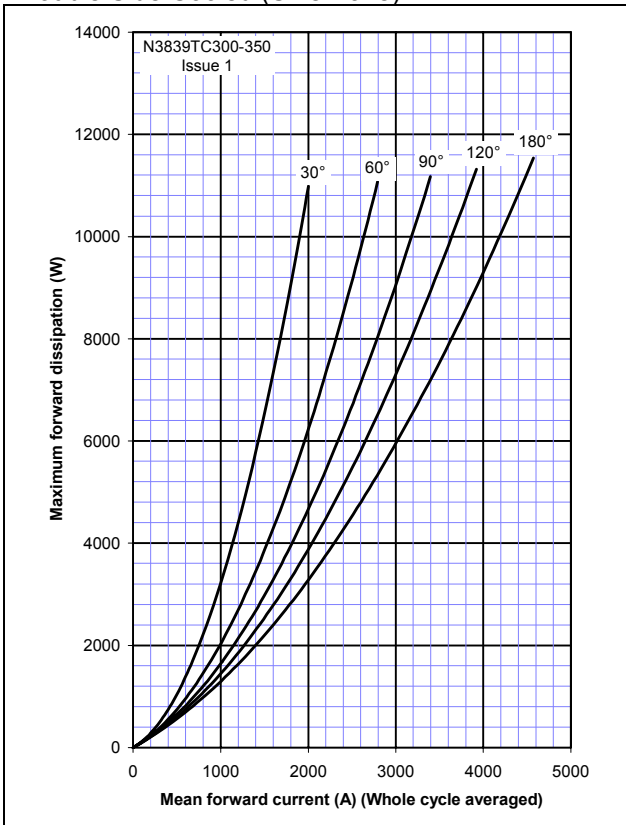

Figure 10 – On-state current vs. Heatsink temperature - Double Side Cooled (Sine wave)

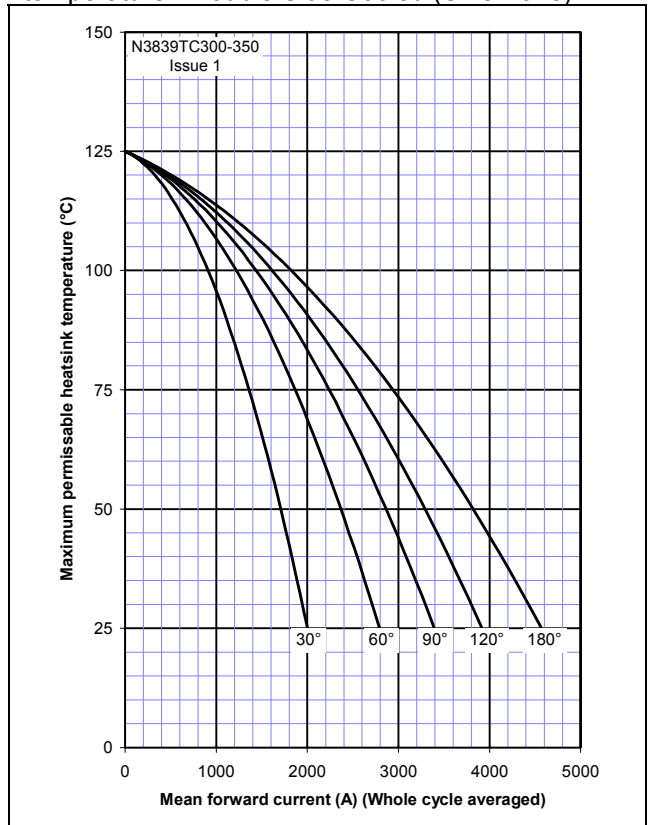

Figure 11 – On-state current vs. Power dissipation – Double Side Cooled (Square wave)

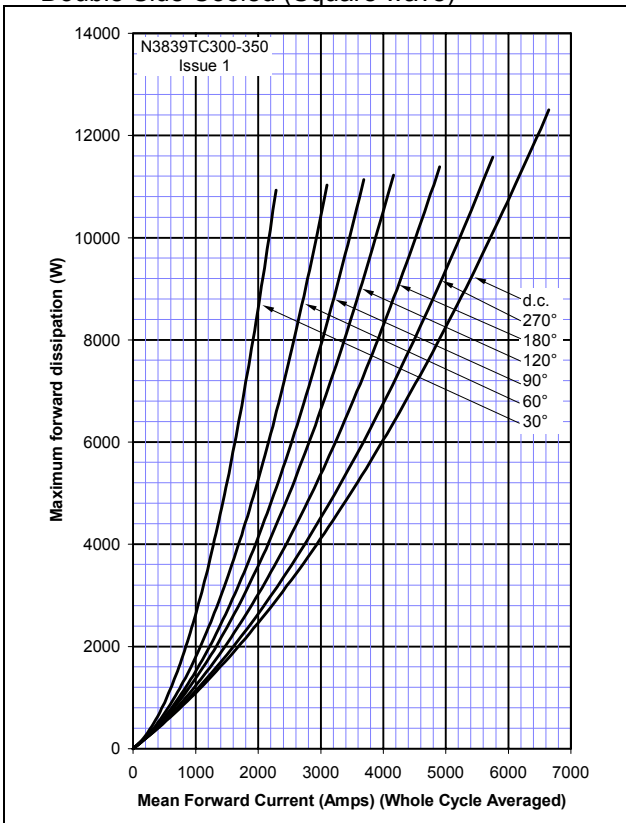

Figure 12 – On-state current vs. Heatsink temperature – Double Side Cooled (Square wave)

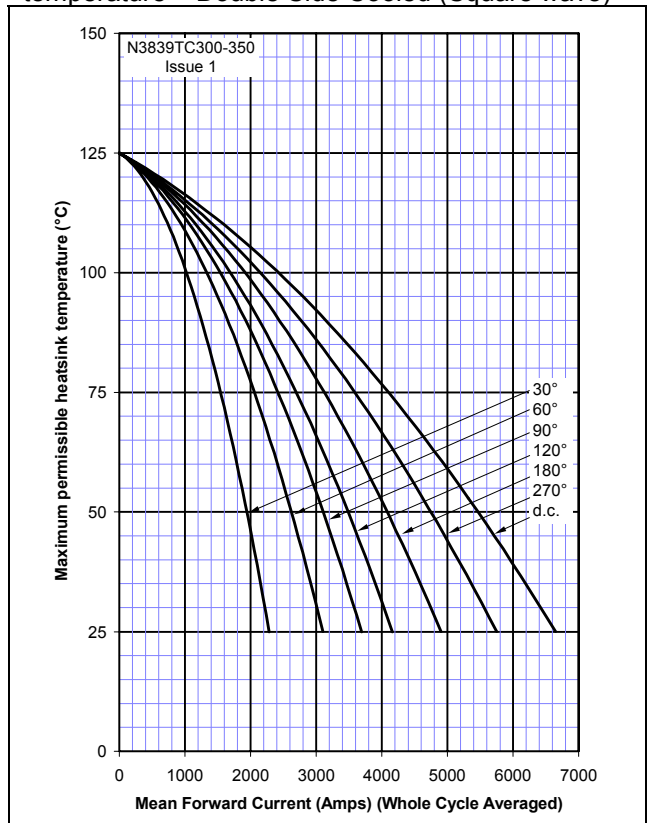

Figure 13 – On-state current vs. Power dissipation – Single Side Cooled (Sine wave)

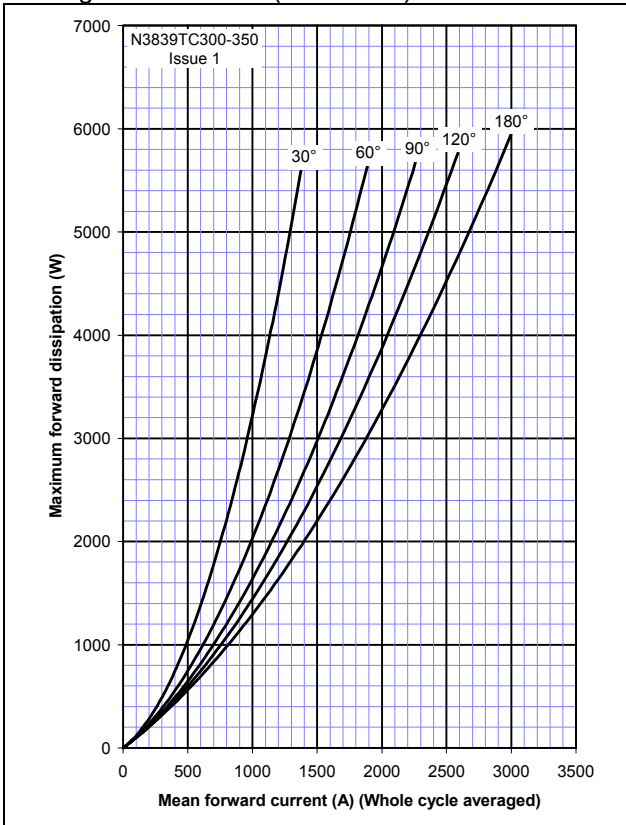

Figure 14 – On-state current vs. Heatsink temperature – Single Side Cooled (Sine wave)

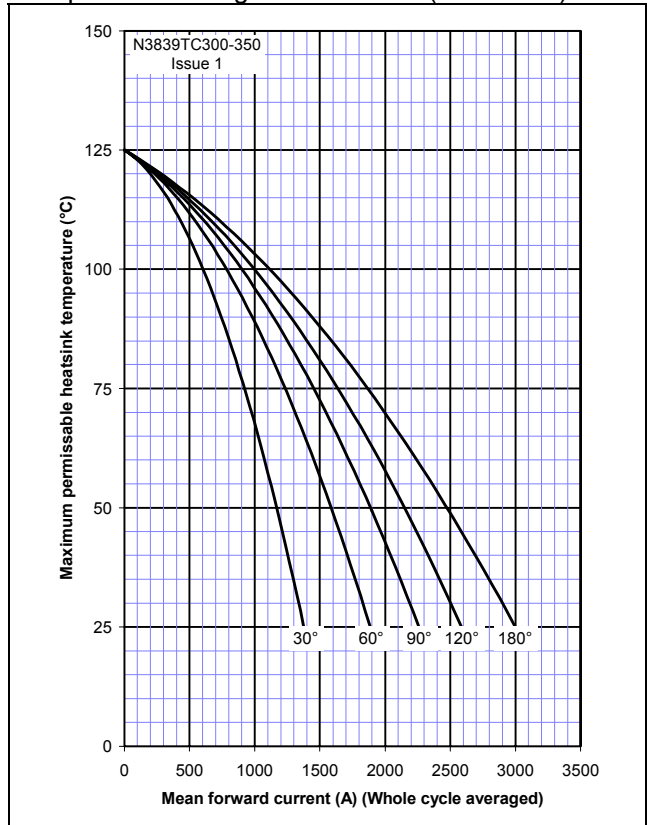

Figure 15 – On-state current vs. Power dissipation – Single Side Cooled (Square wave)

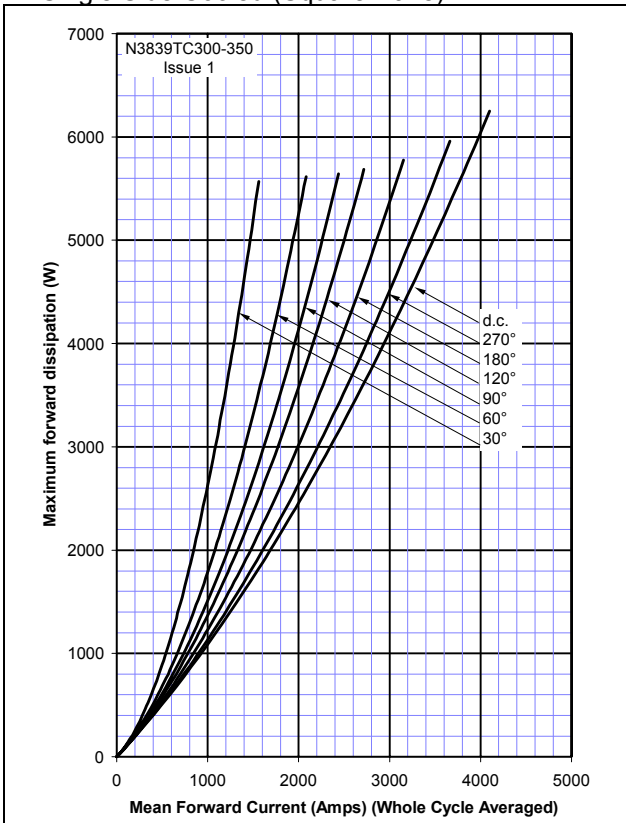

Figure 16 – On-state current vs. Heatsink temperature – Single Side Cooled (Square wave)

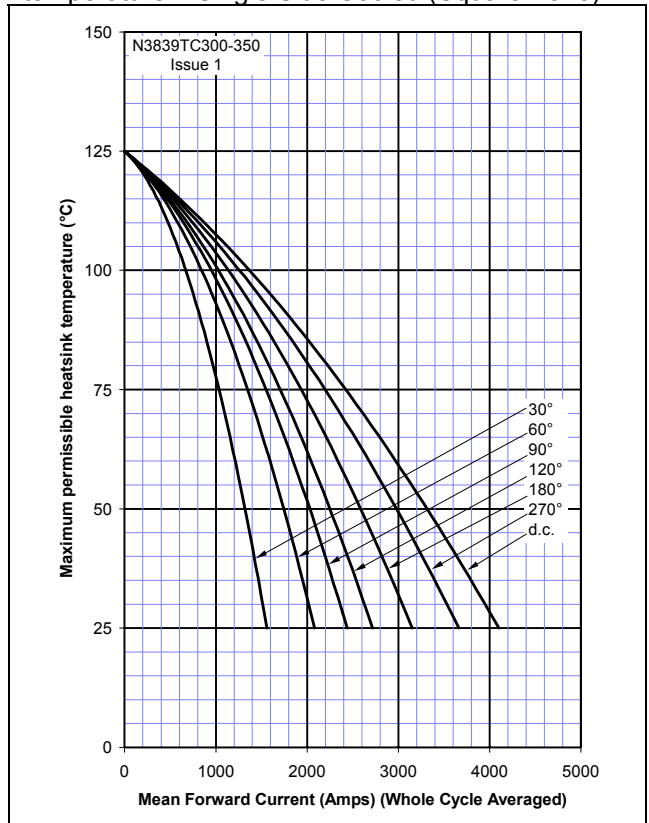
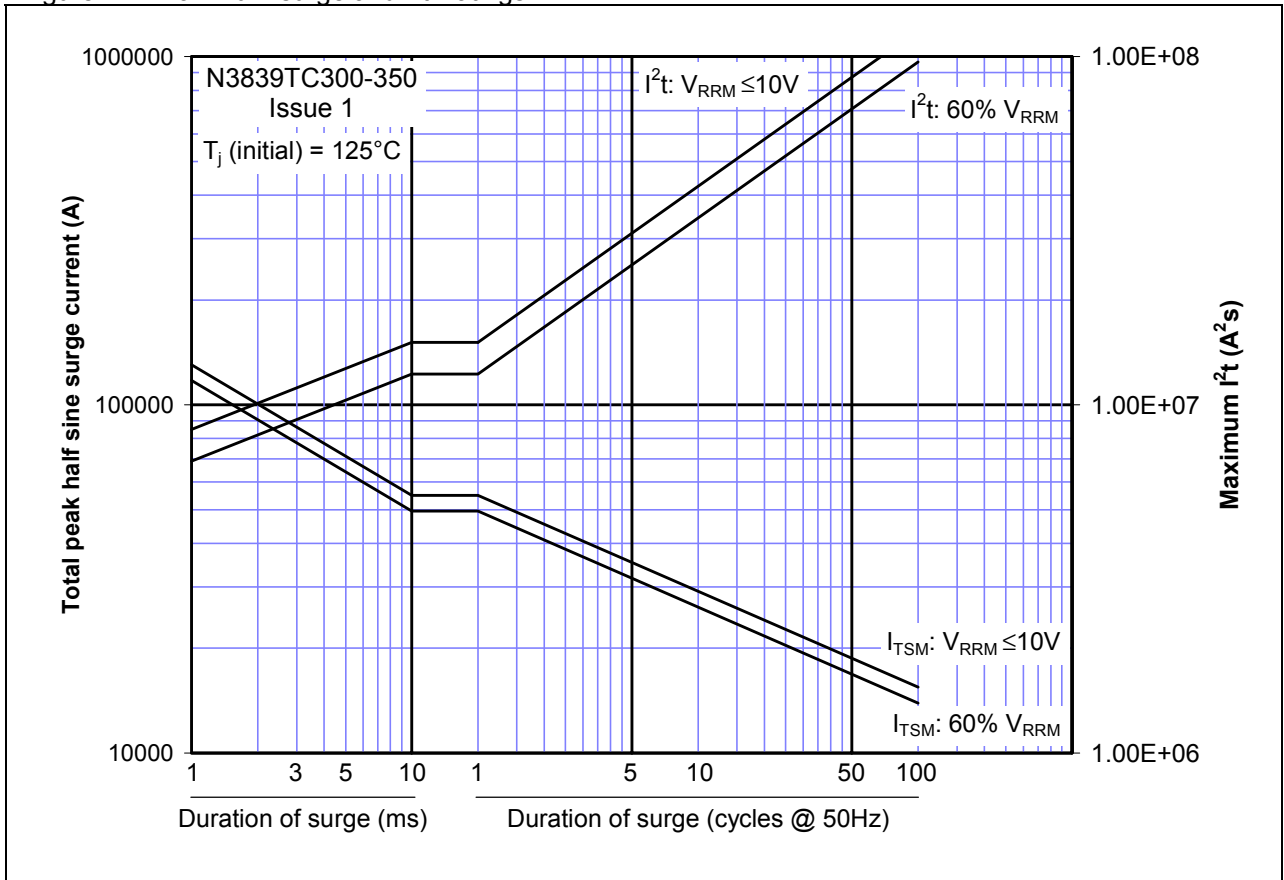
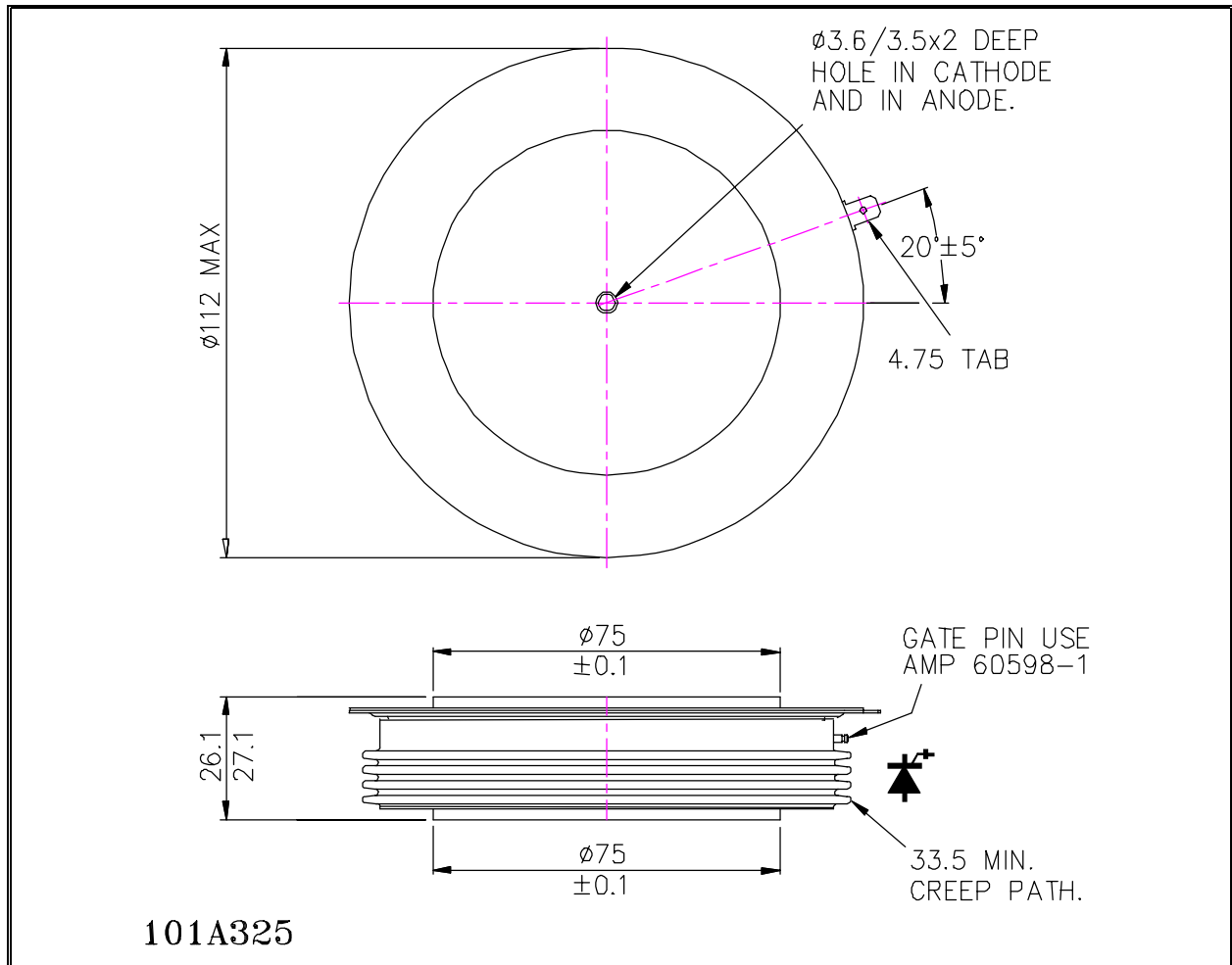

Figure 17 - Maximum surge and I^2t Ratings



Outline Drawing & Ordering Information



ORDERING INFORMATION			
(Please quote 10 digit code as below)			
N3839	TC	◆◆	◆
Fixed Type Code	Fixed outline code	Voltage code $V_{DRM}/100$ 30-35	Fixed turn-off time code

Order code: N3839TC340 – 3400V V_{DRM} , V_{RRM} , 26.1mm clamp height capsule.

IXYS Semiconductor GmbH
 Edisonstraße 15
 D-68623 Lampertheim
 Tel: +49 6206 503-0
 Fax: +49 6206 503-627
 E-mail: marcom@ixys.de

WESTCODE
 An IXYS Company

Westcode Semiconductors Ltd
 Langley Park Way, Langley Park,
 Chippenham, Wiltshire, SN15 1GE.
 Tel: +44 (0)1249 444524
 Fax: +44 (0)1249 659448
 E-mail: WSL.sales@westcode.com

IXYS Corporation
 3540 Bassett Street
 Santa Clara CA 95054 USA
 Tel: +1 (408) 982 0700
 Fax: +1 (408) 496 0670
 E-mail: sales@ixys.net

www.westcode.com

www.ixys.com

Westcode Semiconductors Inc
 3270 Cherry Avenue
 Long Beach CA 90807 USA
 Tel: +1 (562) 595 6971
 Fax: +1 (562) 595 8182
 E-mail: WSI.sales@westcode.com

The information contained herein is confidential and is protected by Copyright. The information may not be used or disclosed except with the written permission of and in the manner permitted by the proprietors Westcode Semiconductors Ltd.

© Westcode Semiconductors Ltd.

In the interest of product improvement, Westcode reserves the right to change specifications at any time without prior notice.

Devices with a suffix code (2-letter, 3-letter or letter/digit/letter combination) added to their generic code are not necessarily subject to the conditions and limits contained in this report.