

LEAST MATERIAL CONDITION

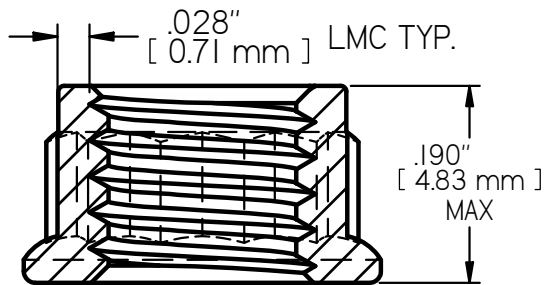
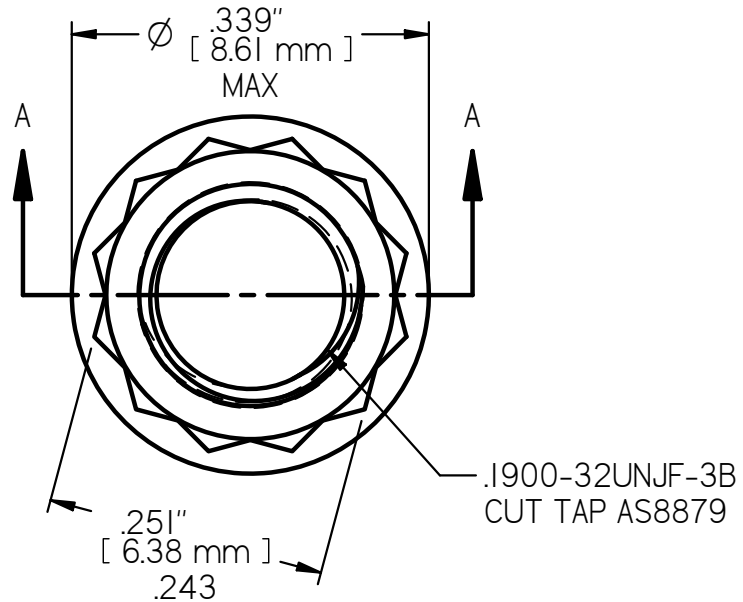

SECTION A-A
6X SCALE

NAS1804-3 LOCK NUT
AXIAL STRENGTH: 4,070 LBS. [18,105 N.] MIN