

LEAST MATERIAL CONDITION

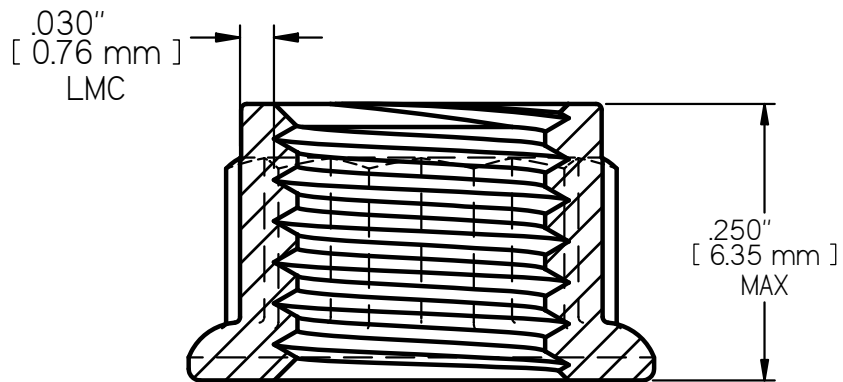
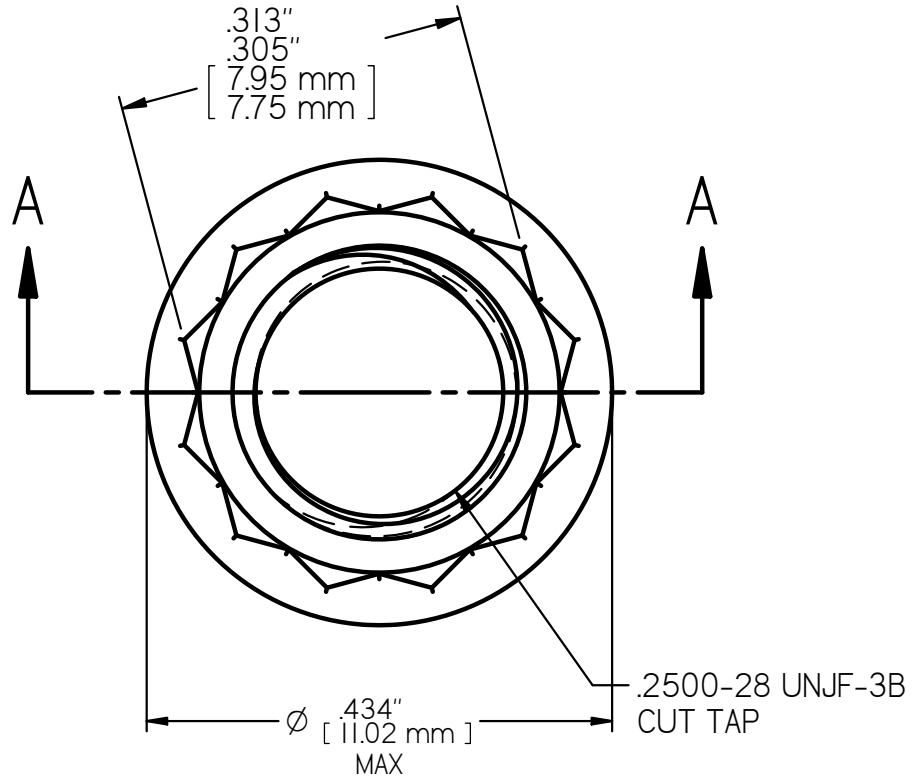

SECTION A-A
6X SCALE

NAS1804-4 LOCK NUT
AXIAL STRENGTH: 7,270 LBS. [32,339 N.] MIN