

LEAST MATERIAL CONDITION

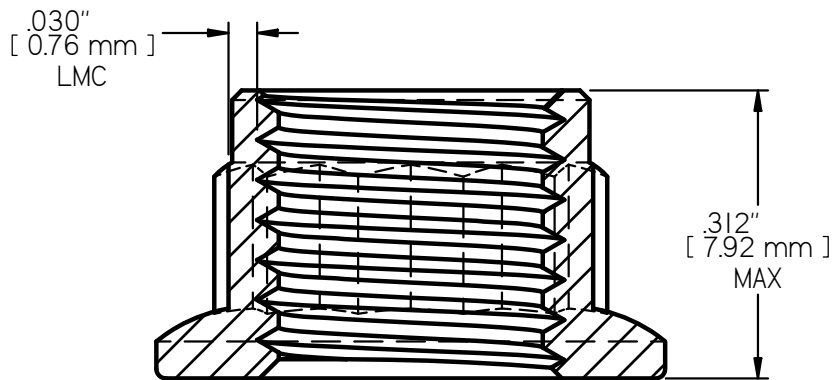
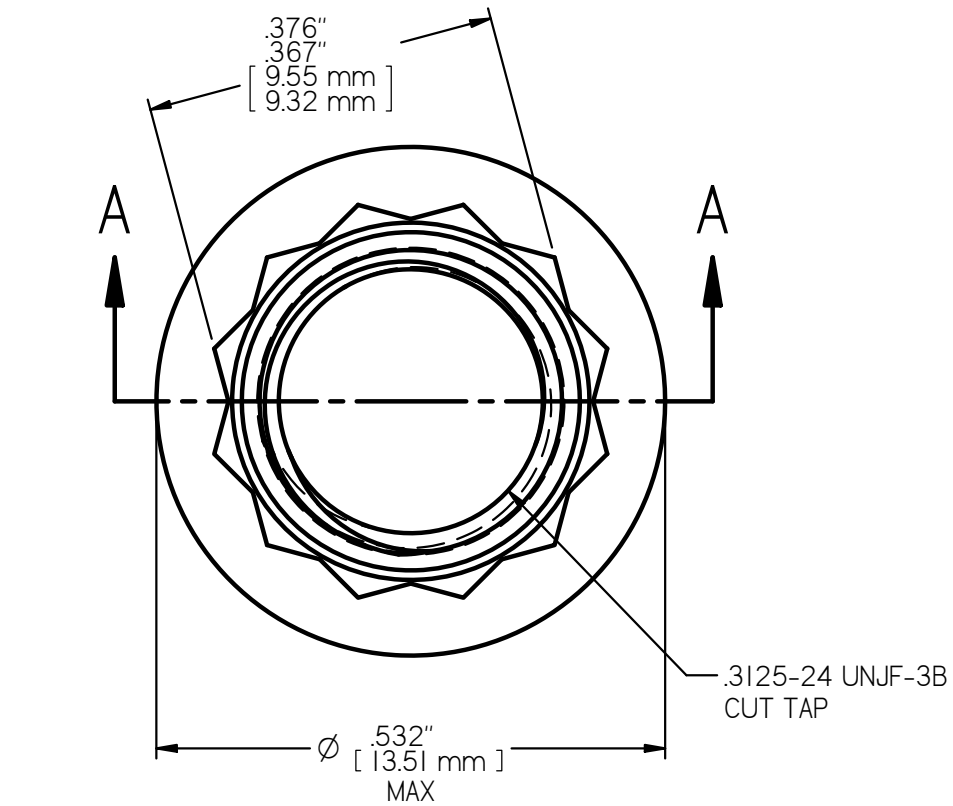

SECTION A-A
5X SCALE

NAS1804-5 LOCK NUT
AXIAL STRENGTH: 11,500 LBS. [51,154 N.] MIN