

LEAST MATERIAL CONDITION

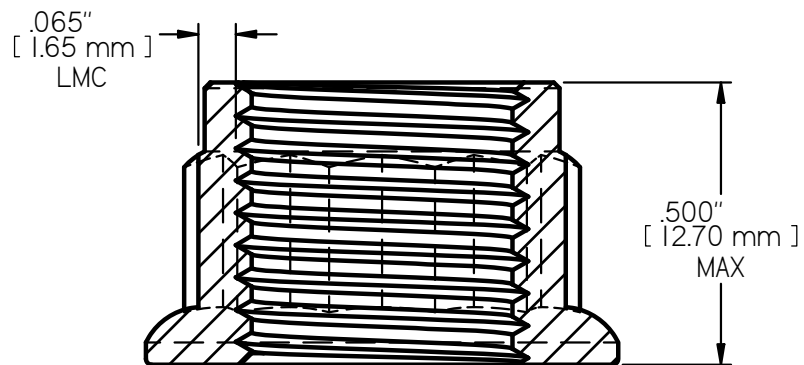
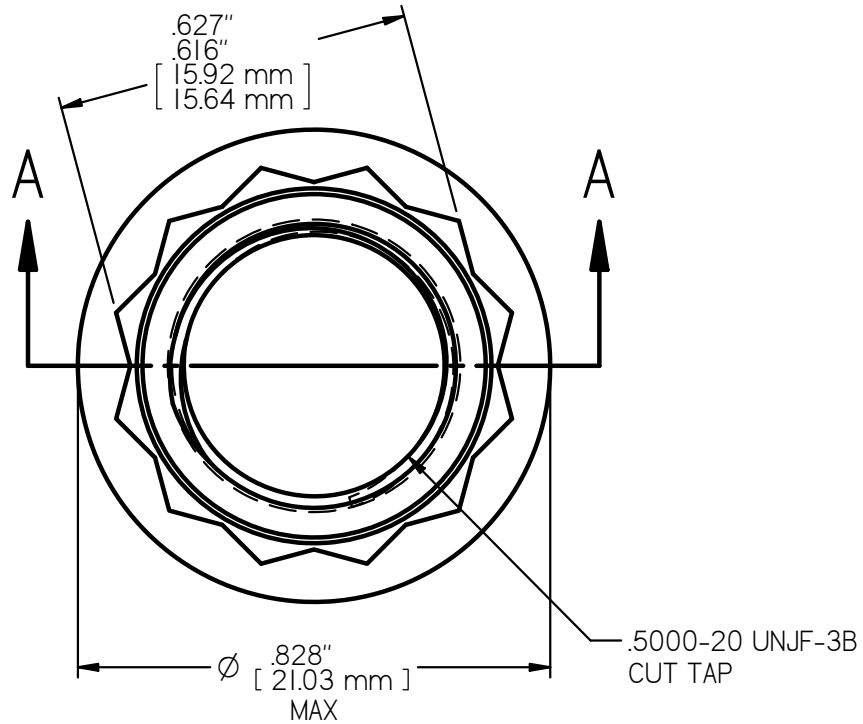

SECTION A-A
3X SCALE

NAS1804-8 LOCK NUT
AXIAL STRENGTH: 30,900 LBS. [137,450 N.] MIN