

LEAST MATERIAL CONDITION

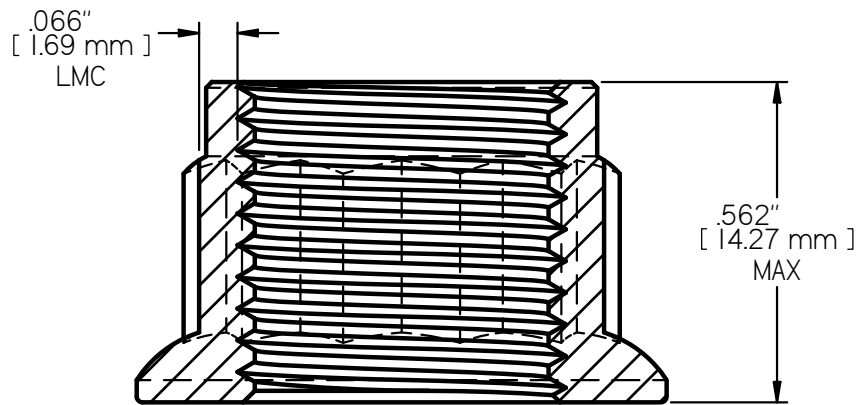
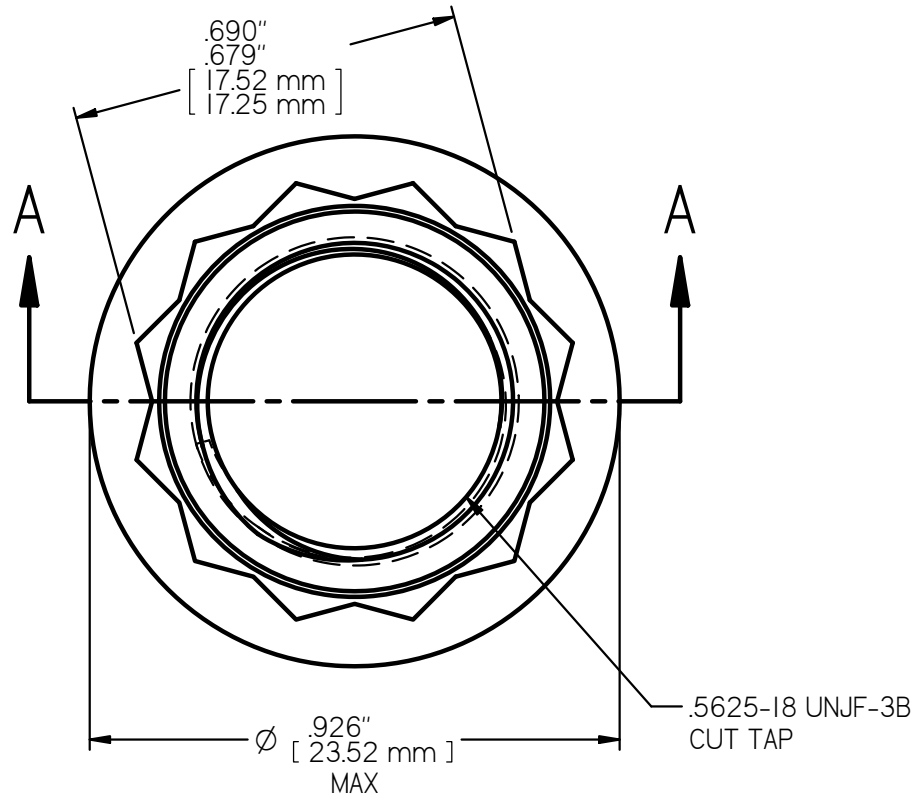

SECTION A-A
3X SCALE

NAS1804-9 LOCK NUT
AXIAL STRENGTH: 39,200 LBS. [174,370 N.] MIN