

NB3M8302C

3.3 V 200 MHz 1:2 LVCMOS/LVTTL Low Skew Fanout Buffer

Description

The NB3M8302C is 1:2 fanout buffer with LVCMOS/LVTTL input and output. The device supports the core supply voltage of 3.3 V (V_{DD} pin) and output supply voltage of 2.5 V or 3.3 V (V_{DDO} pin). The V_{DDO} pin powers the two single ended LVCMOS/LVTTL outputs.

The NB3M8302C is Form, Fit and Function (pin to pin) compatible to ICS8302 and ICS8302I. The NB3M8302C is qualified for industrial operating temperature range.

Features

- Input Clock Frequency up to 200 MHz
- Low Output to Output Skew: 25 ps typical
- Low Part to Part Skew: 250 ps typical
- Low Additive RMS Phase Jitter
- Input Clock Accepts LVCMOS/ LVTTL Levels
- Operating Voltage:
 - ◆ Core Supply: $V_{DD} = 3.3 \text{ V} \pm 5\%$
 - ◆ Output Supply: $V_{DDO} = 3.3 \text{ V} \pm 5\%$ or $2.5 \text{ V} \pm 5\%$
- Operating Temperature Range:
 - ◆ Industrial: -40°C to $+85^{\circ}\text{C}$
- These Devices are Pb-Free and are RoHS Compliant

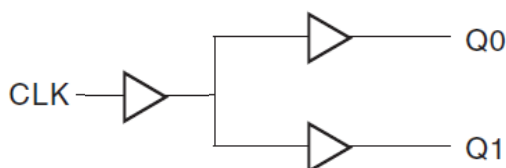

Figure 1. Block Diagram



ON Semiconductor®

www.onsemi.com

MARKING DIAGRAMS*



SOIC-8
D SUFFIX
CASE 751

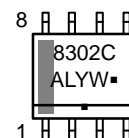

A = Assembly Location
L = Wafer Lot
Y = Year
W = Work Week
▪ = Pb-Free Package

(Note: Microdot may be in either location)

ORDERING INFORMATION

See detailed ordering and shipping information in the package dimensions section on page 5 of this data sheet.

NB3M8302C

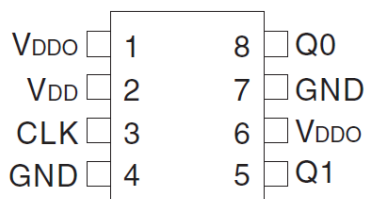

Figure 2. Pin Configuration (Top View)

Table 1. PIN DESCRIPTION

Pin Number	Name	Type	Description
1, 6	VDDO	Output Power	Clock output Supply pin.
2	VDD	Input and Core Power	Input and Core Supply pin.
3	CLK	LVC MOS/LVTTL Input	Clock Input. Internally pull-down.
4, 7	GND	Ground	Supply Ground.
5	Q1	LVC MOS/LVTTL Output	LVC MOS/LVTTL Clock output.
8	Q0	LVC MOS/LVTTL Output	LVC MOS/LVTTL Clock output.

Table 2. MAXIMUM RATINGS

Symbol	Parameter	Condition	Min	Max	Unit
V _{DD} , V _{DDO}	Power Supply		-	4.6	V
V _I	Input Voltage		-0.5	V _{DD} + 0.5 V	V
T _{stg}	Storage Temperature		-65	+150	°C
θ _{JA}	Thermal Resistance (Junction to Ambient) SOIC-8	0 lfpm 500 lfpm		80 55	°C/W
θ _{JC}	Thermal Resistance (Junction to Case) (Note 1)			12-17	°C/W
T _{sol}	Wave Solder	3 sec		265	°C
MSL	Moisture Sensitivity SOIC-8	Indefinite Time Out of Drypack (Note 2)	Level 1		

Stresses exceeding those listed in the Maximum Ratings table may damage the device. If any of these limits are exceeded, device functionality should not be assumed, damage may occur and reliability may be affected.

1. JEDEC standard multilayer board – 2S2P (2 signal, 2 power)
2. For additional information, see Application Note AND8003/D.

NB3M8302C

Table 3. DC OPERATING CHARACTERISTICS

($V_{DD} = V_{DDO} = 3.3\text{ V} \pm 5\%$, $V_{DD} = 3.3\text{ V} \pm 5\%$, $V_{DDO} = 2.5\text{ V} \pm 5\%$; $T_A = -40^\circ\text{C}$ to $+85^\circ\text{C}$)

Symbol	Parameter	Condition	Min	Typ	Max	Unit
R_{IN}	Input Pull-down Resistor (CLK Pin)			51		$k\Omega$
C_{IN}	Input Capacitance			4		pF
R_{OUT}	Output Impedance (Note 3)		5	7	12	Ω
C_{PD}	Power Dissipation Capacitance (per output)	$V_{DD} = V_{DDO} = 3.465\text{ V}$		22		pF
		$V_{DD} = 3.465\text{ V}$, $V_{DDO} = 2.625\text{ V}$		16		
V_{DD}	Core Supply Voltage		3.135	3.3	3.465	V
I_{IH}	Input High Current	$V_{IN} = V_{DD} = 3.465\text{ V}$			150	μA
I_{IL}	Input Low Current	$V_{DD} = 3.465\text{ V}$, $V_{IN} = 0.0\text{ V}$	-0.5			μA

3. Outputs terminated with $50\ \Omega$ to $V_{DDO}/2$. See Figure 4 for supply considerations.

Product parametric performance is indicated in the Electrical Characteristics for the listed test conditions, unless otherwise noted. Product performance may not be indicated by the Electrical Characteristics if operated under different conditions.

Table 4. DC OPERATING CHARACTERISTICS ($T_A = -40^\circ\text{C}$ to $+85^\circ\text{C}$)

Symbol	Parameter	Condition	Min	Max	Unit
--------	-----------	-----------	-----	-----	------

$V_{DD} = 3.3\text{ V} \pm 5\%$, $V_{DDO} = 2.5\text{ V} \pm 5\%$

V_{DDO}	Output Supply Voltage		2.375	2.625	V
V_{OH}	Output HIGH Voltage	$I_{OH} = -16\text{ mA}$	2.1		V
		$I_{OH} = -100\ \mu\text{A}$	2.2		
		$50\ \Omega$ to $V_{DDO}/2$	1.8		
V_{OL}	Output LOW Voltage	$I_{OL} = 16\text{ mA}$		0.15	V
		$I_{OL} = 100\ \mu\text{A}$		0.2	
		$50\ \Omega$ to $V_{DDO}/2$		0.5	

$V_{DD} = V_{DDO} = 3.3\text{ V} \pm 5\%$

V_{DDO}	Output Supply Voltage		3.135	3.465	V
V_{OH}	Output HIGH Voltage	$I_{OH} = -16\text{ mA}$	2.9		V
		$I_{OH} = -100\ \mu\text{A}$	2.9		
		$50\ \Omega$ to $V_{DDO}/2$	2.6		
V_{OL}	Output LOW Voltage	$I_{OL} = 16\text{ mA}$		0.15	V
		$I_{OL} = 100\ \mu\text{A}$		0.2	
		$50\ \Omega$ to $V_{DDO}/2$		0.5	

Table 5. DC OPERATING CHARACTERISTICS ($T_A = -40^\circ\text{C}$ to $+85^\circ\text{C}$; $V_{DD} = V_{DDO} = 3.3\text{ V} \pm 5\%$, $V_{DD} = 3.3\text{ V} \pm 5\%$, $V_{DDO} = 2.5\text{ V} \pm 5\%$)

Symbol	Parameter	Condition	Min	Max	Unit
I_{DD}	Quiescent Power Supply Current	No Load		13	mA
I_{DDO}	Quiescent Power Supply Current	No Load		4	mA
V_{IH}	Input HIGH Voltage		2	$V_{DD} + 0.3$	V
V_{IL}	Input LOW Voltage		-0.3	1.3	V

NB3M8302C

Table 6. AC CHARACTERISTICS (Note 4)

Symbol	Parameter	Condition	Min	Typ	Max	Unit
--------	-----------	-----------	-----	-----	-----	------

$T_A = -40^{\circ}\text{C}$ to $+85^{\circ}\text{C}$; $V_{DD} = V_{DDO} = 3.3\text{ V} \pm 5\%$

F _{IN}	Input Frequency				200	MHz
t _{PLH}	Propagation Delay (Note 5)	Fin = 200 MHz	1.9		3.1	ns
t _{SKEW}	Output to Output Skew(Note 6)			25	85	ps
	Part to Part Skew (Note 6)			250	800	
t _{SKEWDC}	Output Duty Cycle (see Figure 3)	Fin ≤ 133 MHz	45		55	%
		133 MHz < Fin < 200 MHz	40		60	
tr/tf	Output rise and fall times (Note 7)	20% to 80%, RS = 33 Ω	250		800	ps

$T_A = -40^{\circ}\text{C}$ to $+85^{\circ}\text{C}$; $V_{DD} = 3.3\text{ V} \pm 5\%$, $V_{DDO} = 2.5\text{ V} \pm 5\%$

F _{IN}	Input Frequency				200	MHz
t _{PLH}	Propagation Delay (Note 5)	Fin = 200 MHz	2.0		3.3	ns
t _{SKEW}	Output to Output Skew(Note 6)			25	85	ps
	Part to Part Skew (Note 6)			250	800	
t _{SKEWDC}	Output Duty Cycle (see Figure 3)	Fin ≤ 133 MHz	45		55	%
		133 MHz < Fin < 200 MHz	40		60	
tr/tf	Output rise and fall times (Note 7)	20% to 80%, RS = 33 Ω	200		650	ps

4. Clock input with 50% duty cycle. Outputs terminated with 50 Ω to V_{DDO}/2. See Figures 3 and 4.

5. Measured from V_{DD}/2 of the input to V_{DDO}/2 of the output.

6. Similar input conditions and the same supply voltages. Measured at V_{DDO} /2. See Figures 3 and 4.

7. RS is Series Resistance at the clock outputs.

NOTE: Device will meet the specifications after thermal equilibrium has been established when mounted in a test socket or printed circuit board with maintained transverse airflow greater than 500 lpm. Electrical parameters are guaranteed only over the declared operating temperature range. Functional operation of the device exceeding these conditions is not implied. Device specification limit values are applied individually under normal operating conditions and not valid simultaneously.

NB3M8302C

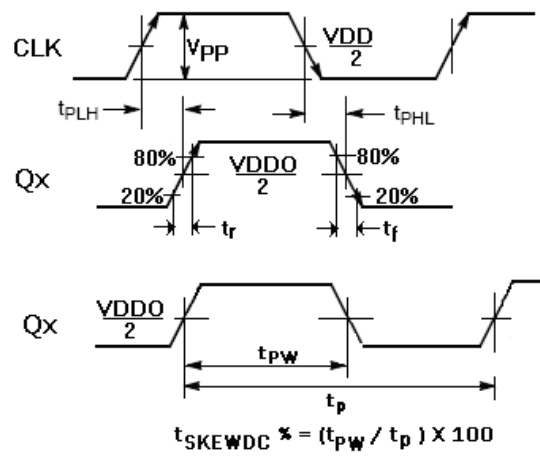
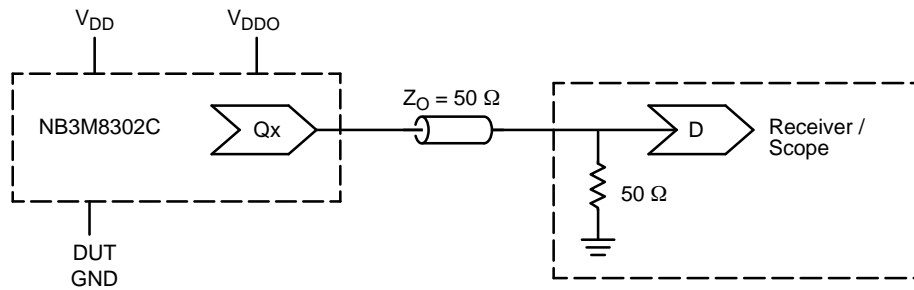

Figure 3. AC Reference Measurement



Spec Condition:	TEST SETUP V _{DD} :	TEST SETUP V _{DDO} :	TEST SETUP DUT GND:
$V_{DD} = V_{DDO} = 3.3 \text{ V} \pm 5\%$	$1.65 \text{ V} \pm 5\%$	$1.65 \text{ V} \pm 5\%$	$-1.65 \text{ V} \pm 5\%$
$V_{DD} = 3.3 \text{ V} \pm 5\%$; $V_{DDO} = 2.5 \text{ V} \pm 5\%$	$2.05 \text{ V} \pm 5\%$	$1.25 \text{ V} \pm 5\%$	$-1.25 \text{ V} \pm 5\%$

Figure 4. Output Driver Typical Device Evaluation and Termination Setup

ORDERING INFORMATION

Device	Package	Shipping [†]
NB3M8302CDG	SOIC-8 (Pb-Free)	98 Units / Rail
NB3M8302CDR2G	SOIC-8 (Pb-Free)	2500 / Tape & Reel

[†]For information on tape and reel specifications, including part orientation and tape sizes, please refer to our Tape and Reel Packaging Specifications Brochure, BRD8011/D.

NB3M8302C

PACKAGE DIMENSIONS

SOIC-8 NB
CASE 751-07
ISSUE AK

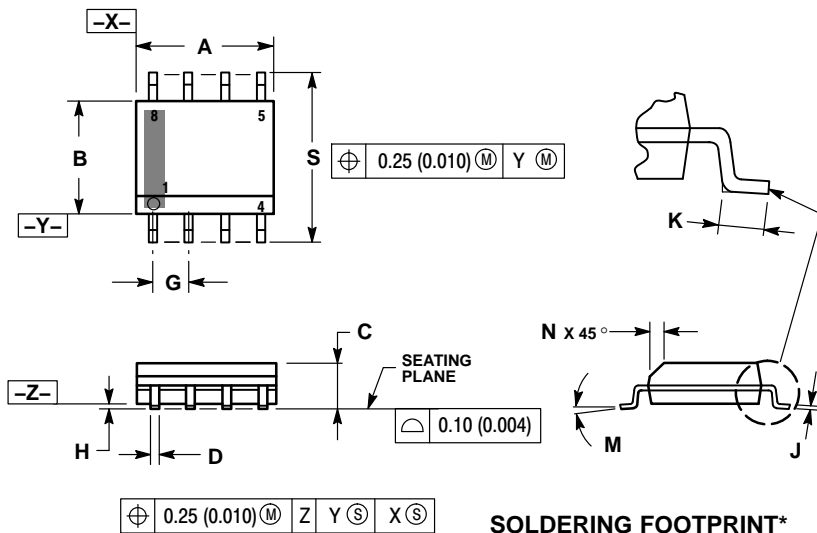

NOTES:

1. DIMENSIONING AND TOLERANCING PER ANSI Y14.5M, 1982.
2. CONTROLLING DIMENSION: MILLIMETER.
3. DIMENSION A AND B DO NOT INCLUDE MOLD PROTRUSION.
4. MAXIMUM MOLD PROTRUSION 0.15 (0.006) PER SIDE.
5. DIMENSION D DOES NOT INCLUDE DAMBAR PROTRUSION. ALLOWABLE DAMBAR PROTRUSION SHALL BE 0.127 (0.005) TOTAL IN EXCESS OF THE D DIMENSION AT MAXIMUM MATERIAL CONDITION.
6. 751-01 THRU 751-06 ARE OBSOLETE. NEW STANDARD IS 751-07.

DIM	MILLIMETERS		INCHES	
	MIN	MAX	MIN	MAX
A	4.80	5.00	0.189	0.197
B	3.80	4.00	0.150	0.157
C	1.35	1.75	0.053	0.069
D	0.33	0.51	0.013	0.020
G	1.27 BSC		0.050 BSC	
H	0.10	0.25	0.004	0.010
J	0.19	0.25	0.007	0.010
K	0.40	1.27	0.016	0.050
M	0°	8°	0°	8°
N	0.25	0.50	0.010	0.020
S	5.80	6.20	0.228	0.244

SOLDERING FOOTPRINT*

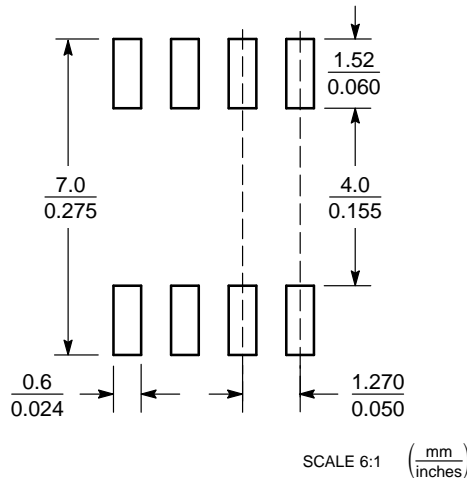

*For additional information on our Pb-Free strategy and soldering details, please download the ON Semiconductor Soldering and Mounting Techniques Reference Manual, SOLDERRM/D.

ON Semiconductor and the are registered trademarks of Semiconductor Components Industries, LLC (SCILLC) or its subsidiaries in the United States and/or other countries. SCILLC owns the rights to a number of patents, trademarks, copyrights, trade secrets, and other intellectual property. A listing of SCILLC's product/patent coverage may be accessed at www.onsemi.com/site/pdf/Patent-Marking.pdf. SCILLC reserves the right to make changes without further notice to any products herein. SCILLC makes no warranty, representation or guarantee regarding the suitability of its products for any particular purpose, nor does SCILLC assume any liability arising out of the application or use of any product or circuit, and specifically disclaims any and all liability, including without limitation special, consequential or incidental damages. "Typical" parameters which may be provided in SCILLC data sheets and/or specifications can and do vary in different applications and actual performance may vary over time. All operating parameters, including "Typicals" must be validated for each customer application by customer's technical experts. SCILLC does not convey any license under its patent rights nor the rights of others. SCILLC products are not designed, intended, or authorized for use as components in systems intended for surgical implant into the body, or other applications intended to support or sustain life, or for any other application in which the failure of the SCILLC product could create a situation where personal injury or death may occur. Should Buyer purchase or use SCILLC products for any such unintended or unauthorized application, Buyer shall indemnify and hold SCILLC and its officers, employees, subsidiaries, affiliates, and distributors harmless against all claims, costs, damages, and expenses, and reasonable attorney fees arising out of, directly or indirectly, any claim of personal injury or death associated with such unintended or unauthorized use, even if such claim alleges that SCILLC was negligent regarding the design or manufacture of the part. SCILLC is an Equal Opportunity/Affirmative Action Employer. This literature is subject to all applicable copyright laws and is not for resale in any manner.

PUBLICATION ORDERING INFORMATION

LITERATURE FULFILLMENT:
Literature Distribution Center for ON Semiconductor
P.O. Box 5163, Denver, Colorado 80217 USA
Phone: 303-675-2175 or 800-344-3860 Toll Free USA/Canada
Fax: 303-675-2176 or 800-344-3867 Toll Free USA/Canada
Email: orderlit@onsemi.com

N. American Technical Support: 800-282-9855 Toll Free
USA/Canada
Europe, Middle East and Africa Technical Support:
Phone: 421 33 790 2910
Japan Customer Focus Center
Phone: 81-3-5817-1050

ON Semiconductor Website: www.onsemi.com
Order Literature: <http://www.onsemi.com/orderlit>
For additional information, please contact your local Sales Representative