



NBM7100A-Q100; NBM7100B-Q100

Coin cell battery life booster with adaptive power optimization

Rev. 1 — 13 September 2024

Product data sheet

1. General description

The NBM7100A/B-Q100 is a battery energy management device designed to maximize usable capacity from non-rechargeable, primary batteries when used in low-voltage, low-power applications requiring burst current loads. The devices overcome voltage drop and battery life limitations associated with extracting high pulse currents (Fig. 1) from lithium primary batteries such as 3 V lithium manganese dioxide (LiMnO₂) coin cells, which are commonly used in wireless, low-power IoT sensor applications.

The NBM7100A/B-Q100 contains two stages of high efficiency DC-DC conversion and an intelligent learning algorithm. The first stage DC-DC conversion transfers energy from the lithium battery at a low constant current to a capacitive storage element. Once charged, a second DC-DC conversion cycle utilizes this stored energy to supply a regulated voltage with high pulse load current capability on the VDH output pin. The battery is never directly subjected to large load pulse currents, resulting in a longer, more predictable battery lifetime.

The proprietary learning algorithm monitors the energy used during repetitive load pulse cycles and optimizes first stage DC-DC conversion to minimize the residual charge in the storage capacitor.

A serial interface allows a microcontroller to change default configuration settings and read-back system information.

Table 1. Related devices

Type number	Bus interface	Auto start	Pulse I _{LOAD}
NBM7100A-Q100	I ² C	Yes	≥ 200 mA
NBM7100B-Q100	SPI	No	≥ 200 mA

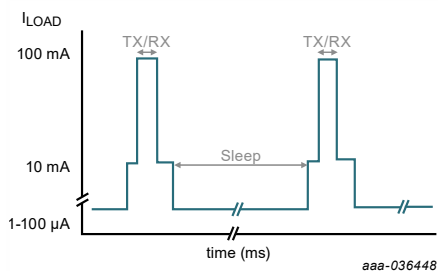

Fig. 1. IoT pulsed load profile

2. Features and benefits

- Automotive product qualification in accordance with AEC-Q100 (Grade 3)
 - Specified from -40 °C to +85 °C
- Programmable constant battery load current: 2 mA to 16 mA
- Protection against battery voltage dips (Brown-out)
- Pulse output current: > 200 mA
- Low ripple regulated programmable output voltage, VDH: 1.8 V to 3.6 V
- Ultra-low standby current: 20 nA (typ)
- Peak conversion efficiency up to 93% with adaptive optimization
- Integrated fuel gauge
- Small 16 pin lead-free package (SOT763-1/DHVQFN16; 2.5 mm × 3.5 mm × 0.85 mm) with side wettable flanks

3. Applications

- Battery powered wireless microcontroller applications (IoT):** Bluetooth®, LoRaWAN®, Sigfox™, LTE-M, NB-IoT, Zigbee, etc.
- Industrial:** temperature, occupancy, e-metering, electronic shelf label, asset tracking, irrigation monitoring
- Automotive:** tire pressure monitors (TPMS), key fobs

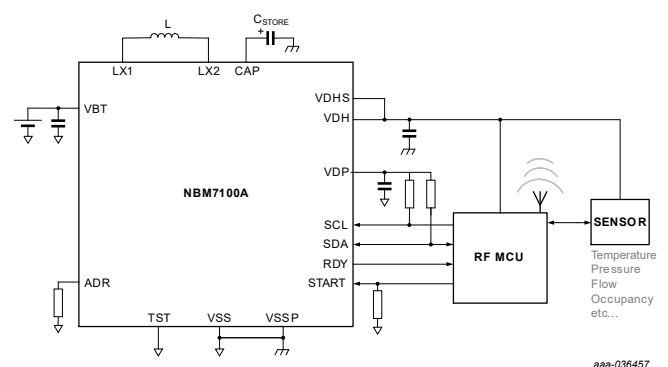

Fig. 2. Simplified Application

4. Ordering information

Table 2. Ordering information

Type number	Package			Version
	Temperature range	Name	Description	
NBM7100ABQ-Q100 NBM7100BBQ-Q100	-40 °C to +85 °C	DHVQFN16	plastic dual in-line compatible thermal enhanced very thin quad flat package; no leads; 16 terminals; body 2.5 × 3.5 × 0.85 mm	SOT763-1

5. Marking

Table 3. Marking codes

Type number	Marking code
NBM7100ABQ-Q100	M7100A
NBM7100BBQ-Q100	M7100B

6. Pin configuration and description

6.1. Pin configuration

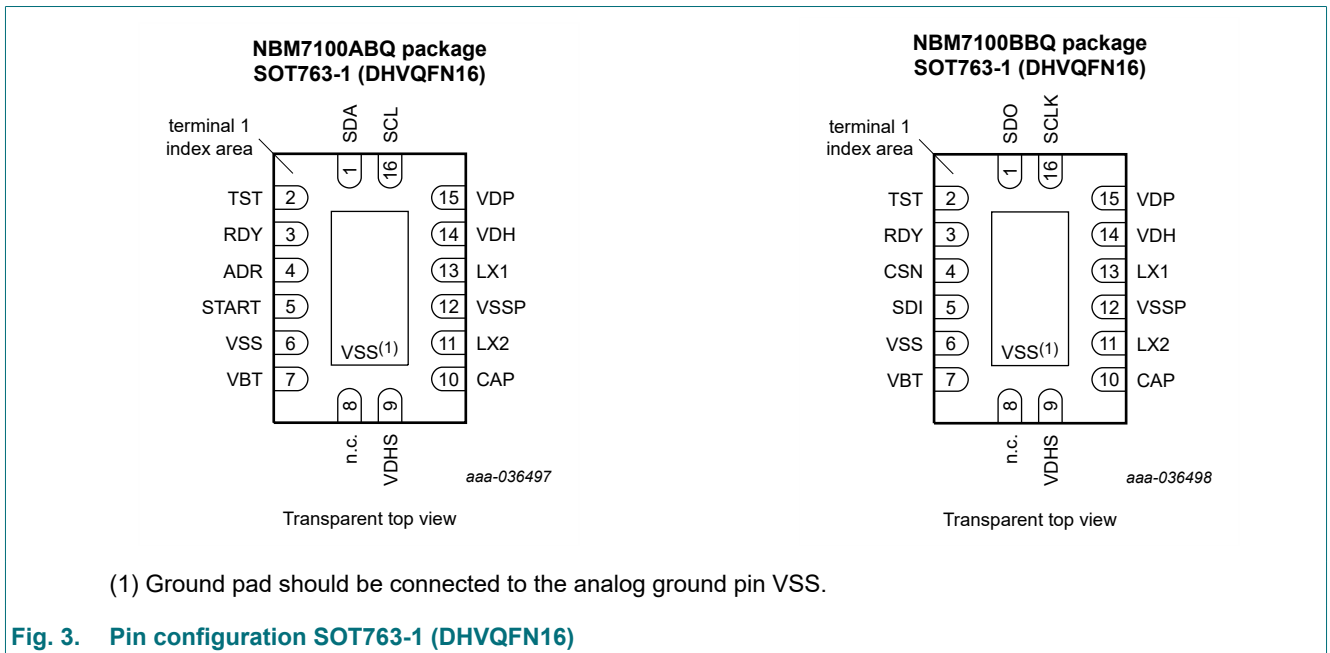

6.2. Pin description

Table 4. Pin description

Pin	Symbol		I/O	Description
	NBM7100A-Q100	NBM7100B-Q100		
1	SDA	SDO	I (A) O (B)	serial data I/O (I ² C) / serial data out MISO (SPI)
2	TST		I	factory test only, tie to VSS
3	RDY		O	status output
4	ADR	CSN	I	address pin (I ² C) / $\overline{\text{chip select}}$ (SPI; active LOW)
5	START	SDI	I	start pin (active high) [1] / serial data in MOSI (SPI)
6	VSS		PWR	analog ground, should be connected to VSSP on PCB
7	VBT		PWR	input supply to the IC (typically from a battery).
8	n.c.		n.a.	not internally connected. connect to PCB pad.
9	VDHS		I	sense input
10	CAP		PWR	storage capacitor
11	LX2		-	inductor connection 2
12	VSSP		PWR	power (switching) ground, should be connected to VSS on PCB
13	LX1		-	inductor connection 1
14	VDH		O	regulated supply output (see output configuration)
15	VDP		O	permanent supply output (see output configuration)
16	SCL	SCLK	I	serial clock input SCL (I ² C); SCLK (SPI)
-	Pad		-	this is not a supply pin; should be soldered to PCB and connected to VSS externally; used to heat-sink the device to the circuit board.

[1] Connect to VSS with a pull-down resistor when not actively driving.

7. Specifications

7.1. Limiting values

Table 5. Limiting values

In accordance with the Absolute Maximum Rating System (IEC 60134). Voltages are referenced to GND (ground = 0 V).

Symbol	Parameter	Conditions	Min	Max	Unit
V_{VBT}	supply voltage pin VBT		-0.3	6.0	V
V_I	input voltage	VDHS NBM7100A-Q100: ADR, START, SCL, SDA NBM7100B-Q100: CSN, SDI, SDO and SCLK	-0.3	$V_{VDP}+0.3$	V
V_O	output voltage	VDH and VDP	-0.3	6.0	V
V_{CAP}	storage voltage pin CAP		-0.3	12.0	V
I_O	output current	VDH, LX1, LX2 and CAP	-	500	mA
T_{amb}	ambient temperature		-40	+85	°C
T_{stg}	storage temperature		-65	+150	°C

7.2. ESD ratings

Table 6. ESD ratings

			Value	Unit
V_{ESD}	electrostatic discharge voltage	HBM: ANSI/ESDA/JEDEC JS-001 Class 2	± 2000	V
		CDM: ANSI/ESDA/JEDEC JS-002 Class C2a	± 500	V

7.3. Thermal information

Table 7. Thermal information

Thermal resistance according to JEDEC51-5 and -7

Symbol	Parameter	SOT763-1	Unit
$R_{\theta JA}$	junction-to-ambient thermal resistance	82	K/W
$R_{\theta JC(TOP)}$	junction-to-case (top) thermal resistance	50	K/W
Ψ_{JT}	junction-to-top characterization parameter	7	K/W

7.4. Recommended operating conditions

Table 8. Recommended operating conditions

Voltages are referenced to GND (ground = 0 V).

Symbol	Parameter	Conditions	Min	Max	Unit
V_{VBT}	supply voltage	VBT pin	2.4	3.6	V
$V_{I/O}$	input/output voltage	RDY NBM7100A-Q100: SCL, SDA, START, ADR NBM7100B-Q100: CSN, SDI, SDO, SCLK	0	V_{VDP}	V
I_O	output current	VDP pin (Standby state)	0	5	mA
I_O	output current	VDH pin (Active state)	0	200	mA

7.5. Recommended components

Table 9. Recommended components

Nominal component values, not including tolerance or derating factors. [1]

Symbol	Parameter	Min	Nom	Max	Unit
C_{VBT}	capacitance on VBT	1	2	-	μF
C_{VDP}	capacitance on VDP	1	2	-	μF
C_{VDH}	capacitance on VDH	22	-	-	μF
C_{CAP}	energy storage capacitance	4.7	-	470	μF
L [2]	inductance between LX1 and LX2	-	15 [3]	-	μH

[1] Nominal component values shown - does not include derating factors.

[2] Ensure inductor saturation current, I_{SAT} , rating > 1 A.

[3] Assume $\pm 20\%$ tolerance.

7.6. Electrical characteristics

Table 10. Static characteristics

At recommended operating conditions; voltages are referenced to GND (ground = 0 V); typical values are at 25°C (unless otherwise noted).

$V_{VBT} = 3.0\text{ V}$; $C_{VBT} = 1\ \mu\text{F}$; $C_{VDP} = 1\ \mu\text{F}$; $C_{VDH} = 22\ \mu\text{F}$; $L = 15\ \mu\text{H}$; unless otherwise specified.

Symbol	Parameter	Conditions	$T_{amb} = -40\text{ °C to }+85\text{ °C}$			Unit
			Min	Typ	Max	
Input						
V_{POR}	power on reset	Device starting voltage for operation at battery insert $T_A = -40\text{ °C}$	1.3	-	2.7	V
V_{POR}	power on reset	Device starting voltage for operation at battery insert $25\text{ °C} \leq T_A \leq 85\text{ °C}$	1.3	-	2.3	V
ϵ_V	absolute voltage error	V_{FIX} , $V_{CAP(max)}$, V_{SET} , and V_{EW}	-	-	5	%
Capacitor charge current from VBT pin						
I_{CH}	charge current	Charge state, $ich = 000b$	1.4	2.0	2.6	mA
		Charge state, $ich = 001b$	2.8	4.0	5.2	mA
		Charge state, $ich = 010b$	5.6	8.0	10.4	mA
		Charge state, $ich = 011b$	11.2	16	20.75	mA
		Charge state, $ich = 100b$ ($V_{CAP} > V_{VBT}$)	35	50	85	mA
EFF_{ch}	converter efficiency	Conversion efficiency (Charge state)	-	80	-	%
Supply current from VBT pin						
I_{Q_STB}	quiescent current	Standby state	-	20	-	nA
I_{Q_CM}	quiescent current	Continuous mode, C_{STORE} charged	-	1.8	-	μA
I_{Q_ACT}	quiescent current	Active state, $I_{LOAD} = 10\text{ mA}$	-	0.4	-	mA

Symbol	Parameter	Conditions	T _{amb} = -40 °C to +85 °C			Unit
			Min	Typ	Max	
VDH output						
V _O	output voltage	Active state, I _{VDH} > 1 mA	-	V _{SET}	-	V
ΔV _{VDH(ΔIO)}	VDH load regulation	see Fig. 12	-	± 1	-	%
EFF _{ACT}	converter efficiency	Active state	-	90	-	%
R _{VDP}	output resistance	pin VDP	-	20	30	Ω
No load detection						
No load detection is active in the Auto mode only. It set the device into standby state when the load current is below the threshold I _{NL} for more the T _{NL} . The detected load detection current is the sum of currents in the VDP and VDH outputs.						
I _{NL}	threshold current	No load Current threshold	-	100	-	μA
T _{NL}	detection time	No load Detection time	-	20	-	ms

Table 11. Logic inputs/outputs (SDA/SDO), RDY, (ADR/CSN), (START/SDI) and (SCL/SCLK) pins

At recommended operating conditions; voltages are referenced to GND (ground = 0 V); typical values are at 25°C (unless otherwise noted).

V_{VBT} = 3.0 V; C_{VBT} = 1 μF; C_{VDP} = 1 μF; C_{VDH} = 22 μF; L = 15 μH; unless otherwise specified.

Symbol	Parameter	Conditions	T _{amb} = -40 °C to +85 °C			Unit
			Min	Typ	Max	
I _I	input current		-	0	-	μA
V _{IL}	LOW-level input voltage		-	-	0.3 x V _{VDP}	V
V _{IH}	HIGH-level input voltage		0.7 x V _{VDP}	-	-	V
V _H	hysteresis voltage		0.16V x V _{VDP}	-	-	V
V _{OL}	LOW-level output voltage	I _{OL} = 3 mA	-	-	0.2 x V _{VDP}	V
V _{OH}	HIGH-level output voltage	I _{OH} = 2 mA	[1]	0.7 x V _{VDP}	-	V

[1] For NBM7100A-Q100 open drain output at SDA pin excluded.

7.7. Dynamic characteristics

Table 12. Timing requirements and switching characteristics of logic inputs/outputs I²C (NBM7100A-Q100, SDA and SCL pins)

At recommended operating conditions; voltages are referenced to GND (ground = 0 V); typical values are at 25°C (unless otherwise noted).

$V_{VBT} = 2.4\text{ V to }3.6\text{ V}$; $C_{VBT} = 1\ \mu\text{F}$; $C_{VDP} = 1\ \mu\text{F}$; $C_{VDH} = 22\ \mu\text{F}$; $L = 15\ \mu\text{H}$. At recommended operating conditions; voltages are referenced to GND (ground = 0 V); for waveforms see Fig. 28; for test circuit see Fig. 31.

Symbol	Parameter	Conditions	T _{amb} = -40 °C to +85 °C			Unit
			Min	Typ	Max	
Timing requirements						
f _{clk}	clock frequency	SCL	-	-	1	MHz
t _{low}	low time	SCL	500	-	-	ns
t _{high}	high time	SCL	260	-	-	ns
t _{su,sta}	set-up time	START; for repeated START condition	260	-	-	ns
t _{h,sta}	hold time	START; for repeated START condition	260	-	-	ns
t _{su,sto}	set-up time	STOP; for STOP condition	260	-	-	ns
t _{buf}	bus free time	between STOP and START	500	-	-	ns
t _{su,dat}	set-up time	SDA	50	-	-	ns
t _{h,dat}	hold time	SDA	0	-	-	ns
t _r	rise time	SCL	-	-	120	ns
t _r	rise time	SDA	-	-	120	ns
t _f	fall time	SCL	-	-	120	ns
t _f	fall time	SDA	-	-	120	ns
Switching characteristics						
t _{vd_dat}	valid time, data	SDA; in Tx mode	-	-	450	ns
t _{vd_ack}	valid time, acknowledge	SDA; in Tx mode	-	-	450	ns
t _{of}	output fall time	in Tx mode, C _L = 10 pF, 70% - 30%	-	-	120	ns

Table 13. Timing requirements and switching characteristics of logic inputs/outputs SPI (NBM7100B-Q100, SDO, CSN, SDI and SCLK pins)

At recommended operating conditions; voltages are referenced to GND (ground = 0 V); typical values are at 25°C (unless otherwise noted).

$V_{VBT} = 2.4 \text{ V to } 3.6 \text{ V}$; $C_{VBT} = 1 \text{ }\mu\text{F}$; $C_{VDP} = 1 \text{ }\mu\text{F}$; $C_{VDH} = 22 \text{ }\mu\text{F}$; $L = 15 \text{ }\mu\text{H}$. At recommended operating conditions; voltages are referenced to GND (ground = 0 V); for waveforms see Fig. 29 and Fig. 30; for test circuit see Fig. 32.

Symbol	Parameter	Conditions	$T_{\text{amb}} = -40 \text{ }^{\circ}\text{C to } +85 \text{ }^{\circ}\text{C}$			Unit
			Min	Typ	Max	
Timing requirements						
f_{clk}	clock frequency	SCLK	-	-	4	MHz
t_{clk}	period time	SCLK; see Fig. 29 ⁽⁵⁾ and Fig. 30 ⁽⁵⁾	250	-	-	ns
t_{CSH}	reset time	CSN; see Fig. 29 ⁽⁶⁾ and Fig. 30 ⁽⁹⁾	200	-	-	ns
t_{low}	low time	SCLK	100	-	-	ns
t_{high}	high time	SCLK	100	-	-	ns
t_{su}	setup time	CSN; see Fig. 29 ⁽³⁾ and Fig. 30 ⁽³⁾	100	-	-	ns
t_{h}	hold time	CSN; see Fig. 29 ⁽⁴⁾ and Fig. 30 ⁽⁴⁾	0	-	-	ns
t_{su}	setup time	SDI; see Fig. 29 ⁽¹⁾ and Fig. 30 ⁽¹⁾	10	-	-	ns
t_{h}	hold time	SDI; see Fig. 29 ⁽²⁾ and Fig. 30 ⁽²⁾	20	-	-	ns
Switching characteristics						
t_{dav}	valid time	SDO; after neg clock edge, incl 3-state/active delay; see Fig. 30 ⁽⁶⁾	-	-	100	ns
t_{rel}	release time	SDO; after CSN transition to high; see Fig. 30 ⁽⁷⁾	-	-	100	ns
t_{f}	fall time	SDO; $C_L = 10 \text{ pF}$, 70% - 30%	-	-	10	ns
t_{r}	rise time	SDO; $C_L = 10 \text{ pF}$, 30% - 70%	-	-	10	ns

Table 14. Switching characteristics of RDY output

At recommended operating conditions; voltages are referenced to GND (ground = 0 V); typical values are at 25°C (unless otherwise noted).

$V_{VBT} = V_{VDP} = 2.4 \text{ V to } 3.6 \text{ V}$; $C_{VBT} = 1 \text{ }\mu\text{F}$; $C_{VDP} = 1 \text{ }\mu\text{F}$; $C_{VDH} = 22 \text{ }\mu\text{F}$; $L = 15 \text{ }\mu\text{H}$. At recommended operating conditions; voltages are referenced to GND (ground = 0 V); for test circuit see Fig. 31 and Fig. 32.

Symbol	Parameter	Conditions	$T_{\text{amb}} = -40 \text{ }^{\circ}\text{C to } +85 \text{ }^{\circ}\text{C}$			Unit
			Min	Typ	Max	
t_{r}	rise time	RDY; $C_L = 10 \text{ pF}$, 30% - 70%	-	-	10	ns
t_{f}	fall time	RDY; $C_L = 10 \text{ pF}$, 70% - 30%	-	-	10	ns
$t_{\text{W(EW)}}$	EW pulse width	RDY; Early Warning active	2.6	-	6.5	μs

7.8. Typical characteristics

At recommended operating conditions; voltages are referenced to GND (ground = 0 V); typical values are at 25°C (unless otherwise noted).

$V_{VBT} = 3.0\text{ V}$; $C_{VBT} = 1\text{ }\mu\text{F}$; $C_{VDP} = 1\text{ }\mu\text{F}$; $C_{VDH} = 22\text{ }\mu\text{F}$; $L = 15\text{ }\mu\text{H}$; unless otherwise specified.

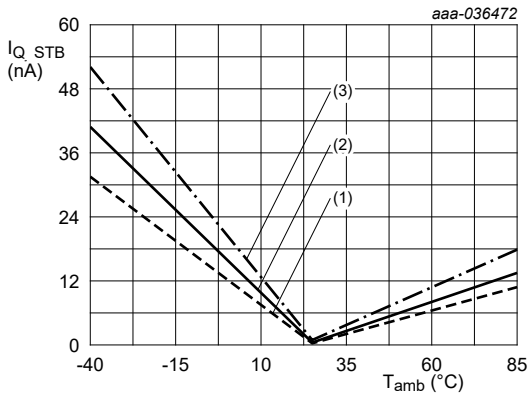

- (1): $V_{VBT} = 2.4\text{ V}$
- (2): $V_{VBT} = 3.0\text{ V}$
- (3): $V_{VBT} = 3.6\text{ V}$

Fig. 4. I_{Q_STB} versus temperature

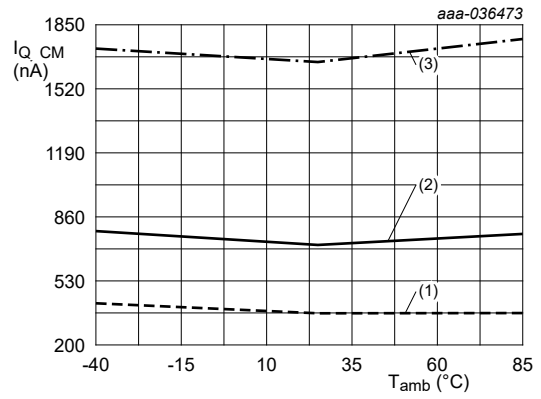

- (1): $V_{VBT} = 2.4\text{ V}$
- (2): $V_{VBT} = 3.0\text{ V}$
- (3): $V_{VBT} = 3.6\text{ V}$

Fig. 5. I_{Q_CM} versus temperature

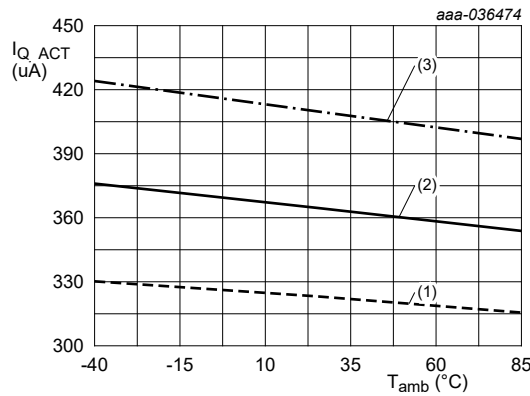

- (1): $V_{VBT} = 2.4\text{ V}$
- (2): $V_{VBT} = 3.0\text{ V}$
- (3): $V_{VBT} = 3.6\text{ V}$

Fig. 6. I_{Q_ACT} versus temperature

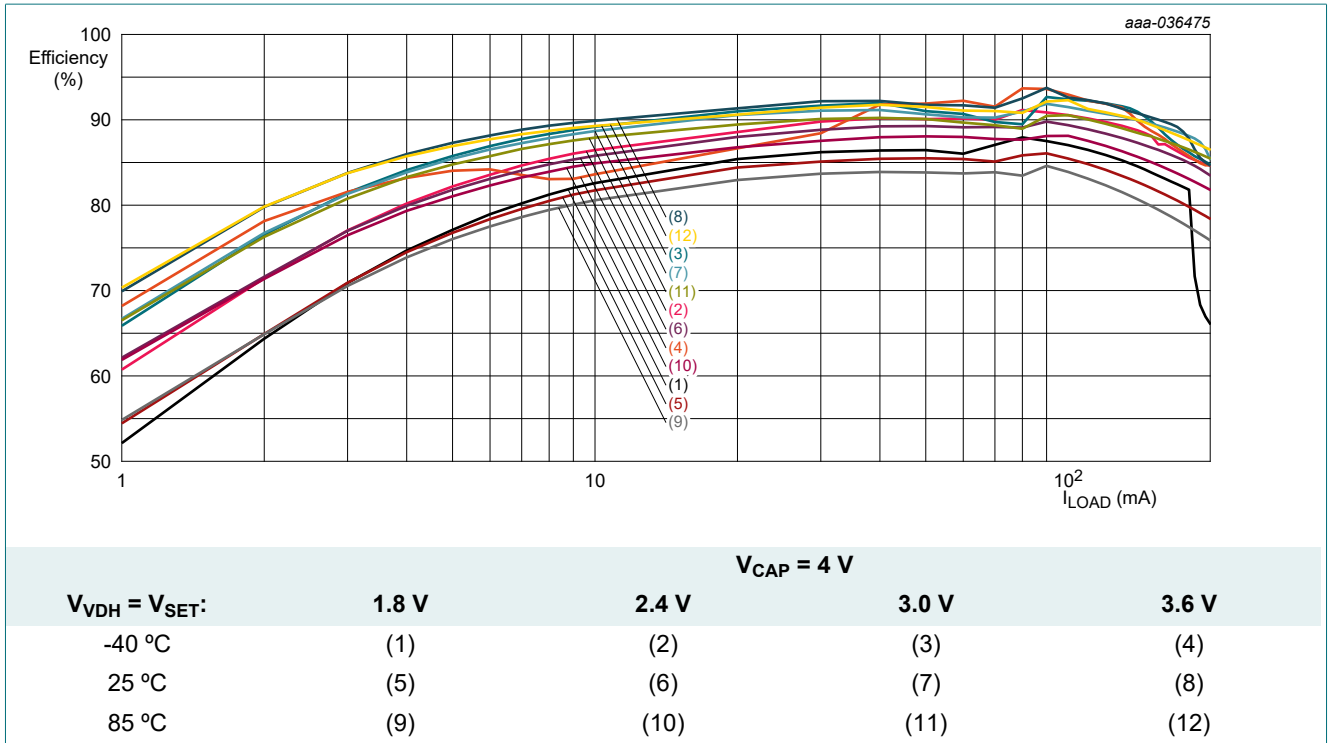

Fig. 7. Active state efficiency versus load current, $V_{CAP} = 4\text{ V}$

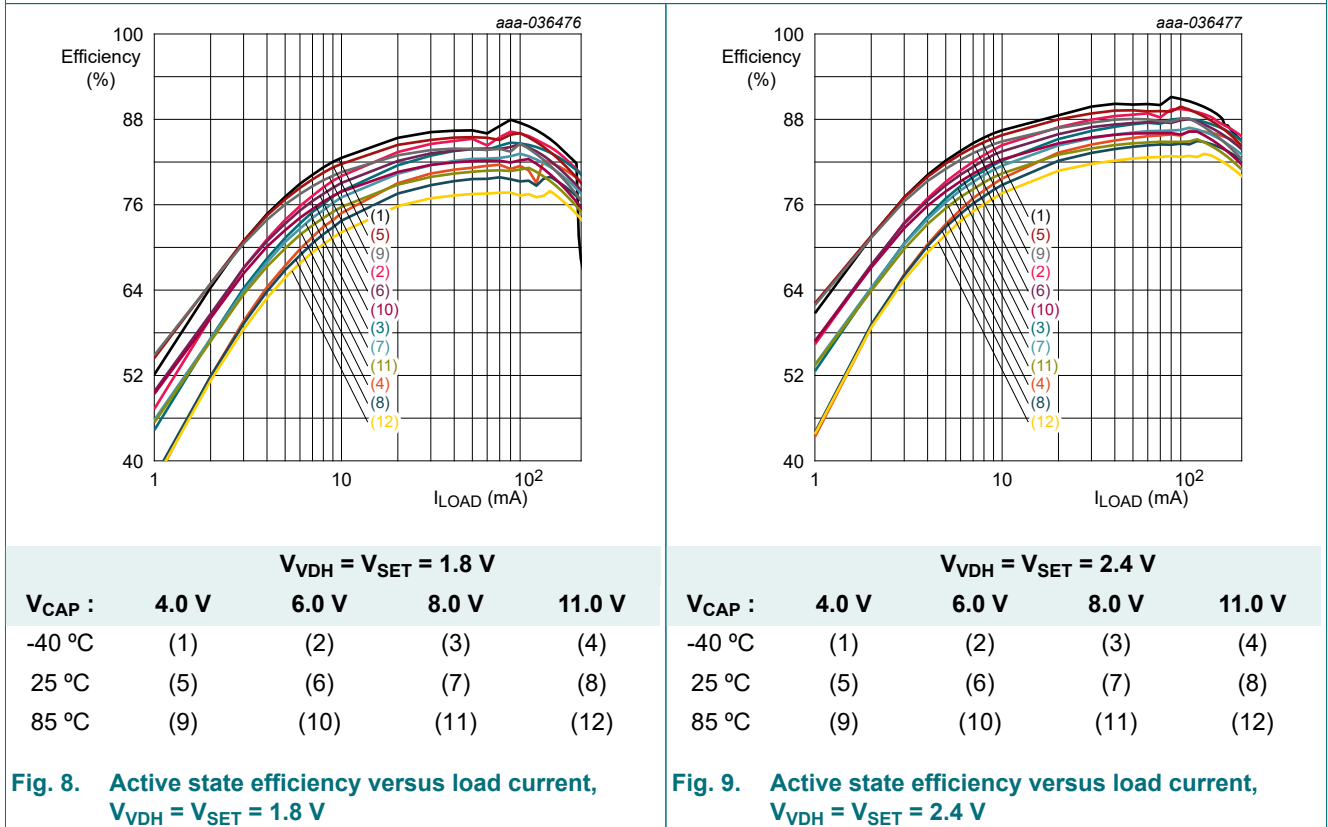
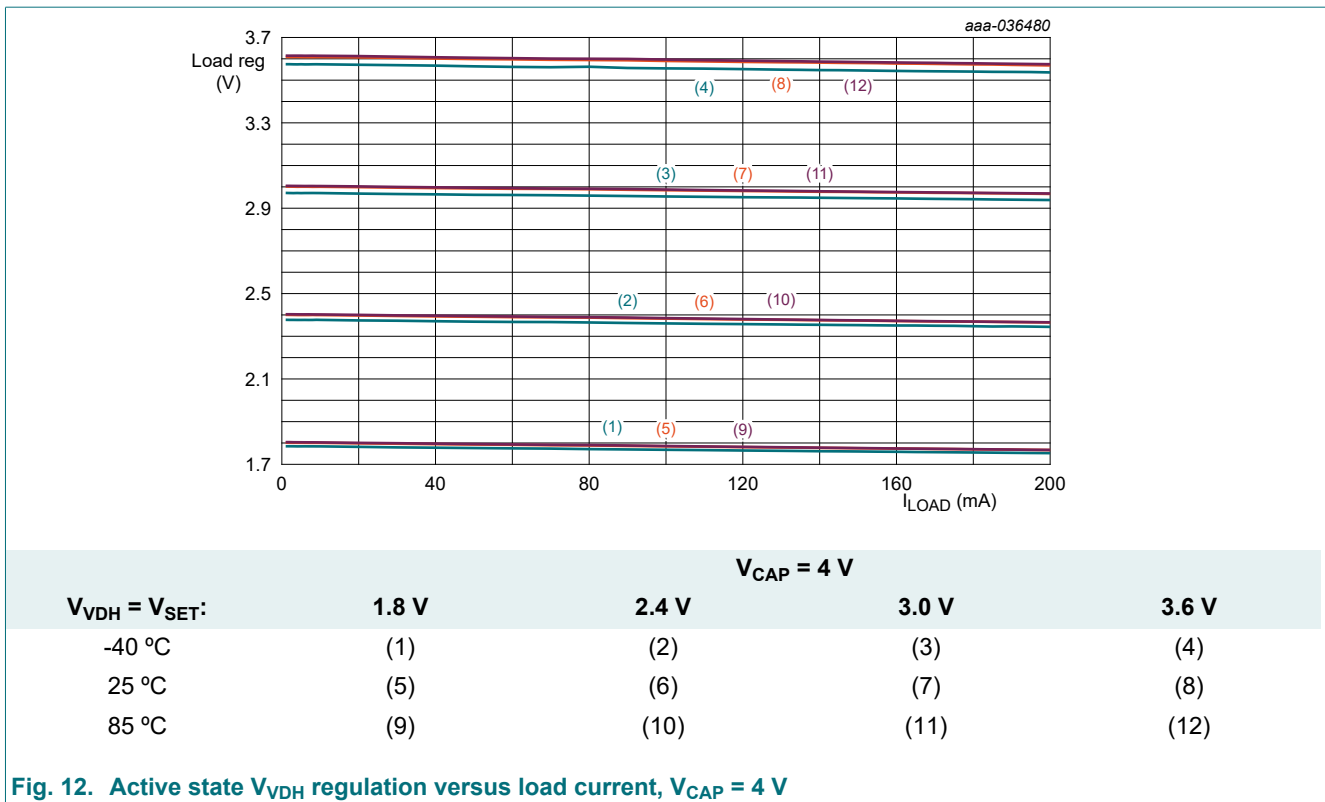
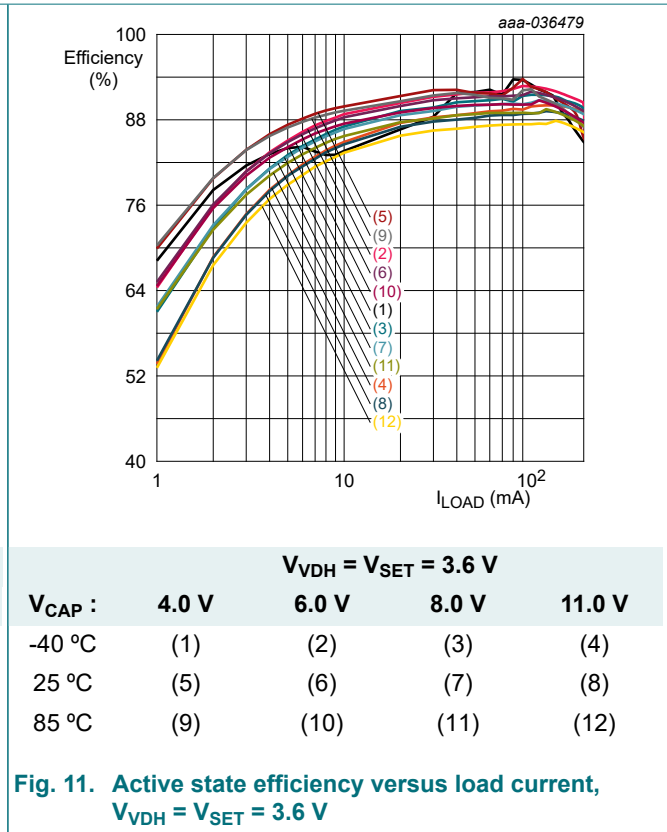
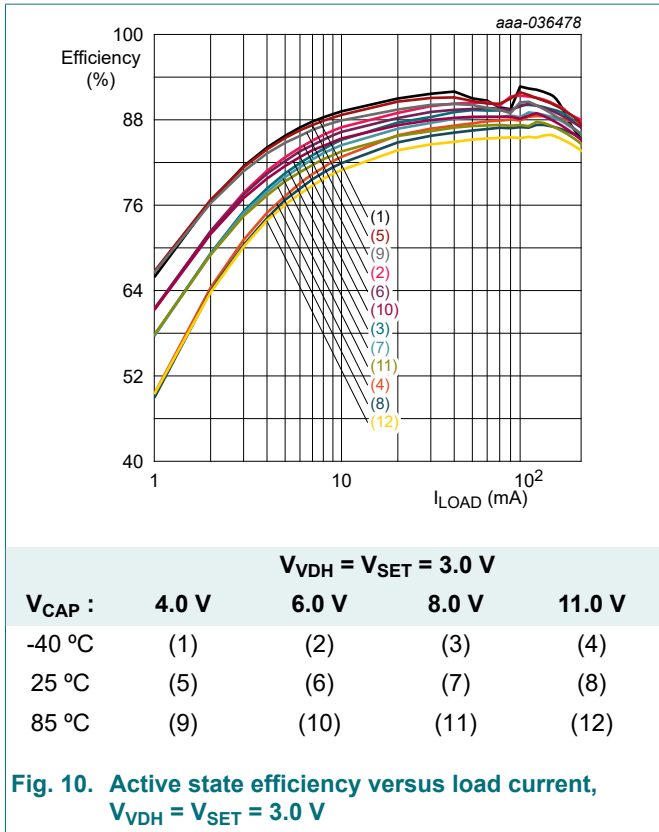
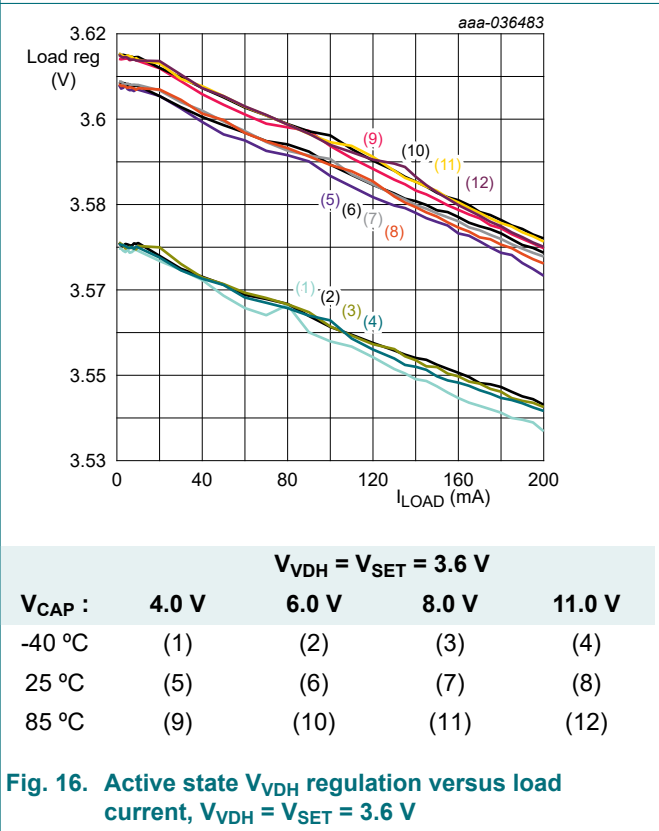
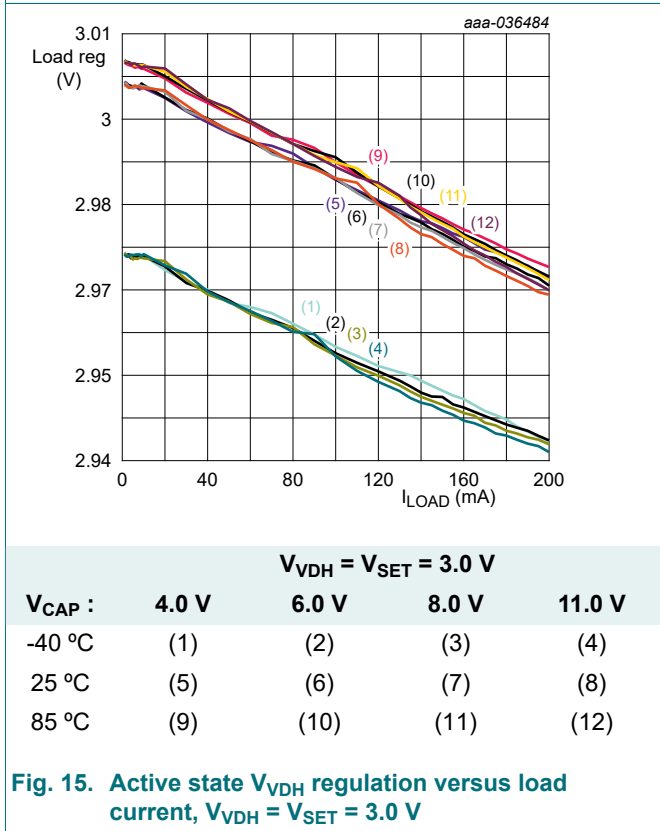
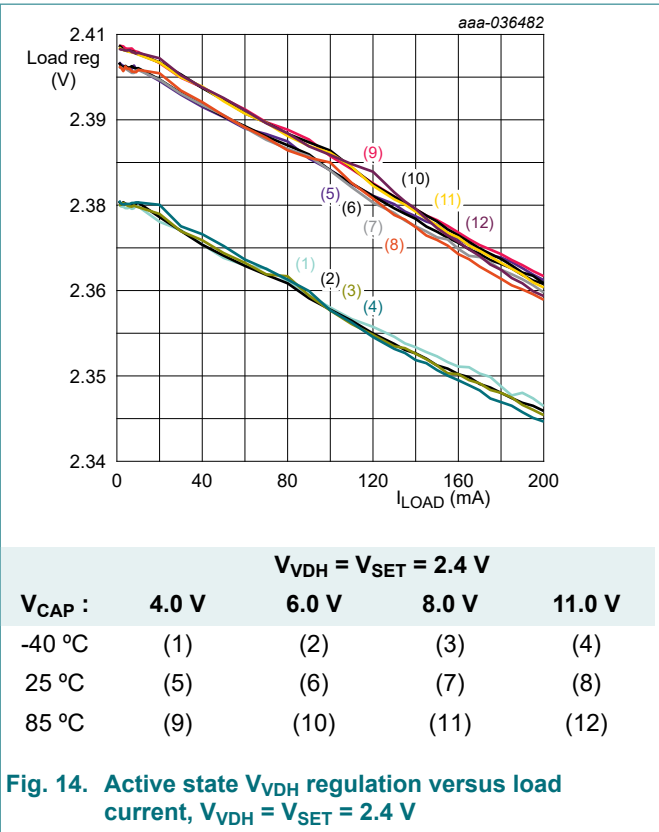
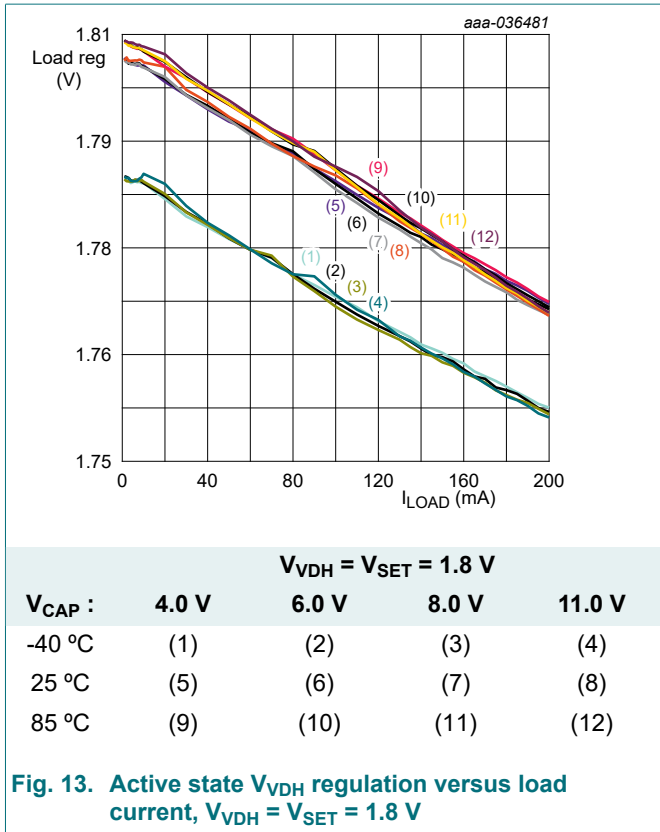

Fig. 8. Active state efficiency versus load current, $V_{VDH} = V_{SET} = 1.8\text{ V}$

Fig. 9. Active state efficiency versus load current, $V_{VDH} = V_{SET} = 2.4\text{ V}$





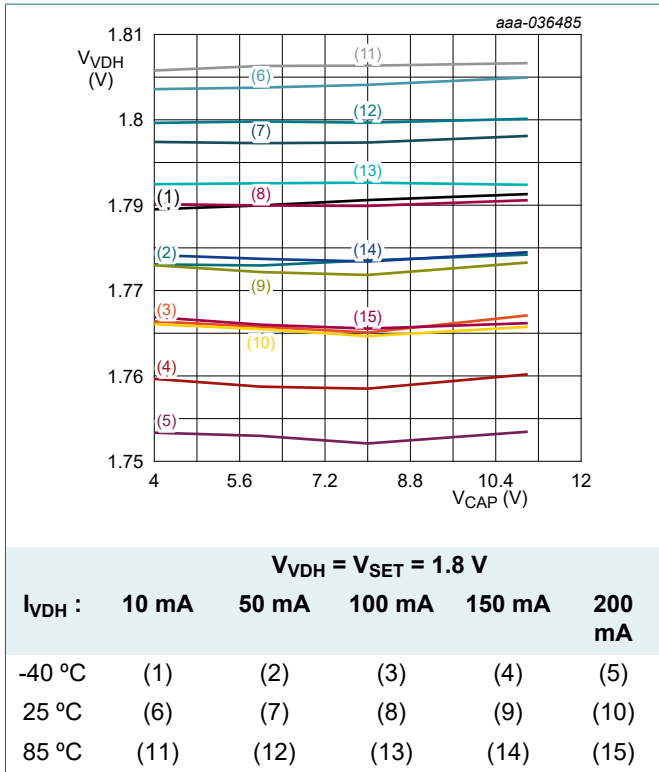

Fig. 17. Active state V_{VDH} regulation versus V_{CAP} , $V_{VDH} = V_{SET} = 1.8\text{ V}$

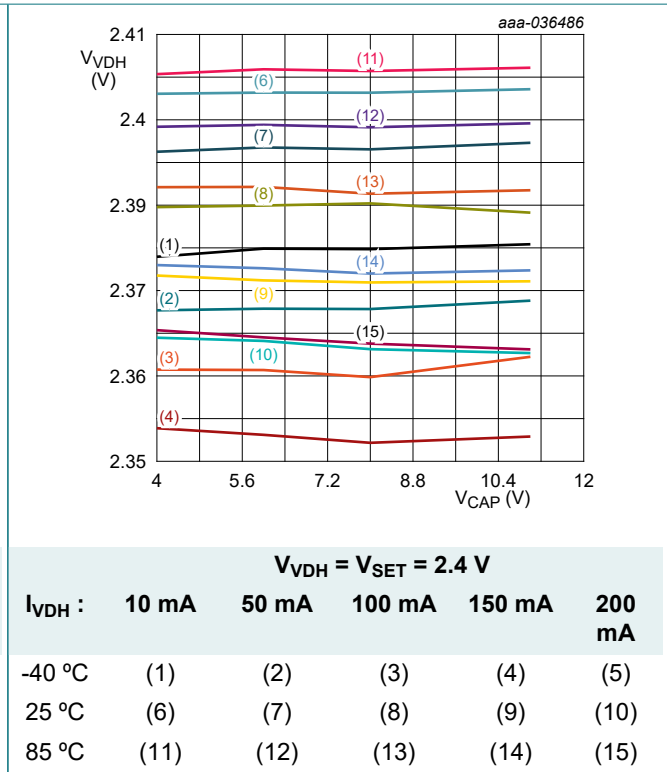

Fig. 18. Active state V_{VDH} regulation versus V_{CAP} , $V_{VDH} = V_{SET} = 2.4\text{ V}$

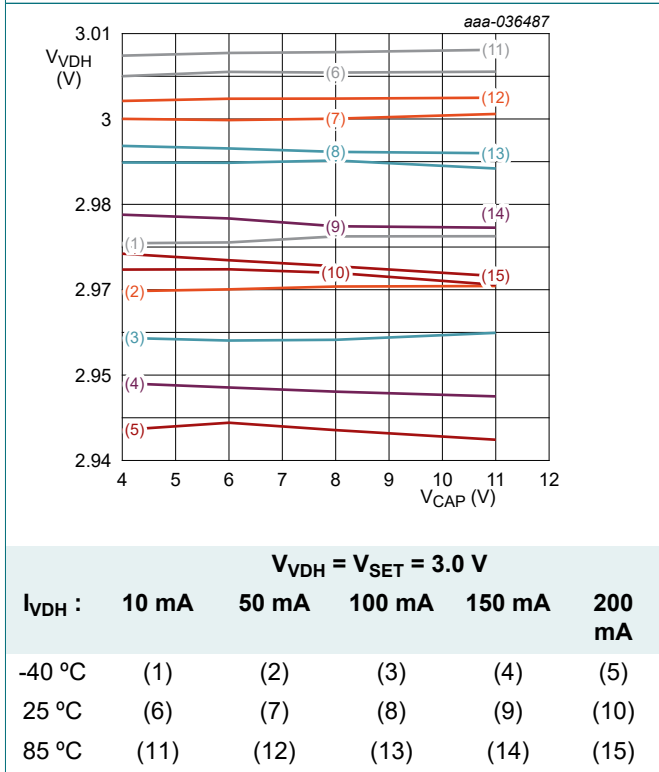

Fig. 19. Active state V_{VDH} regulation versus V_{CAP} , $V_{VDH} = V_{SET} = 3.0\text{ V}$

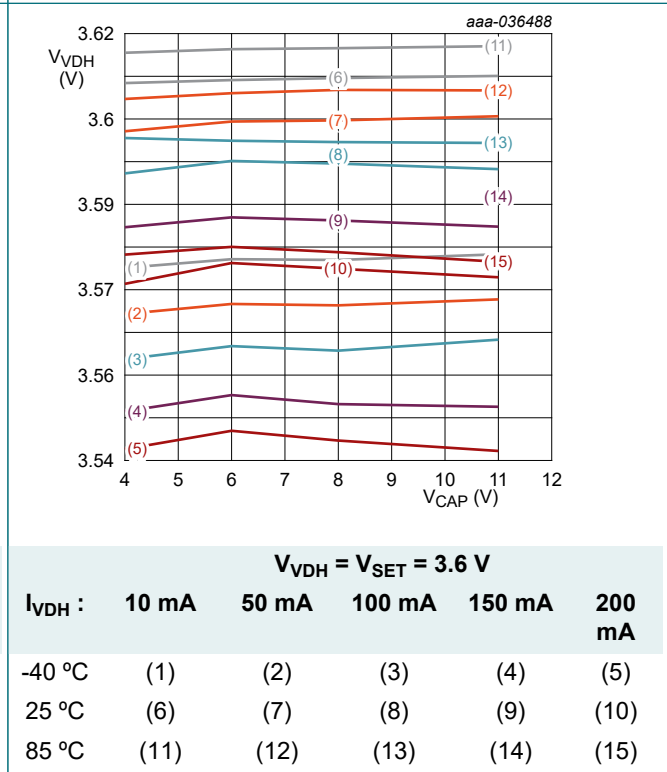
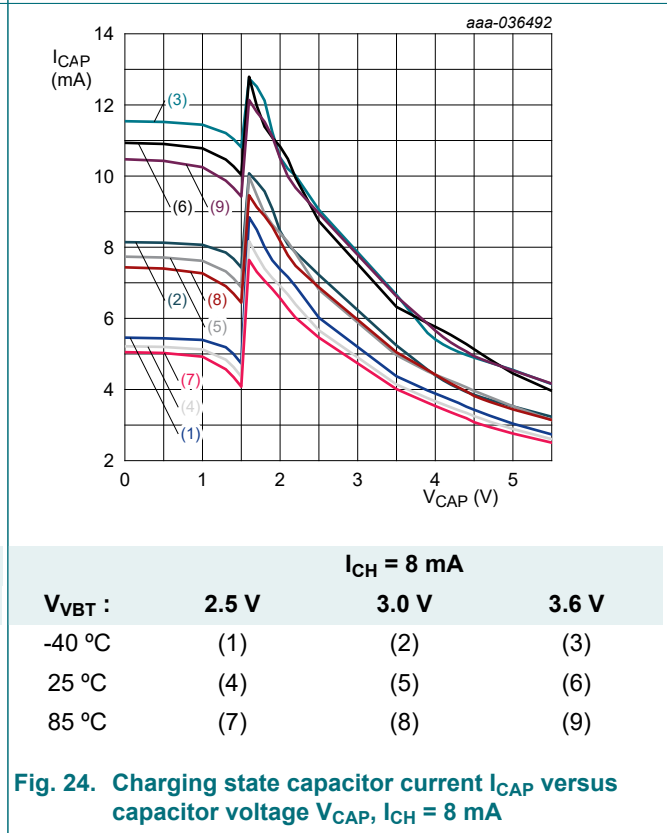
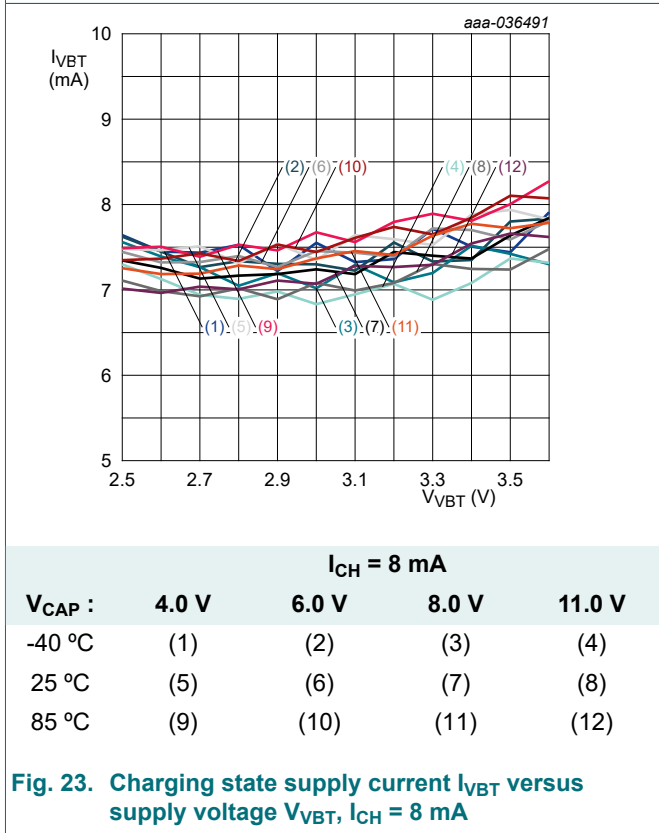
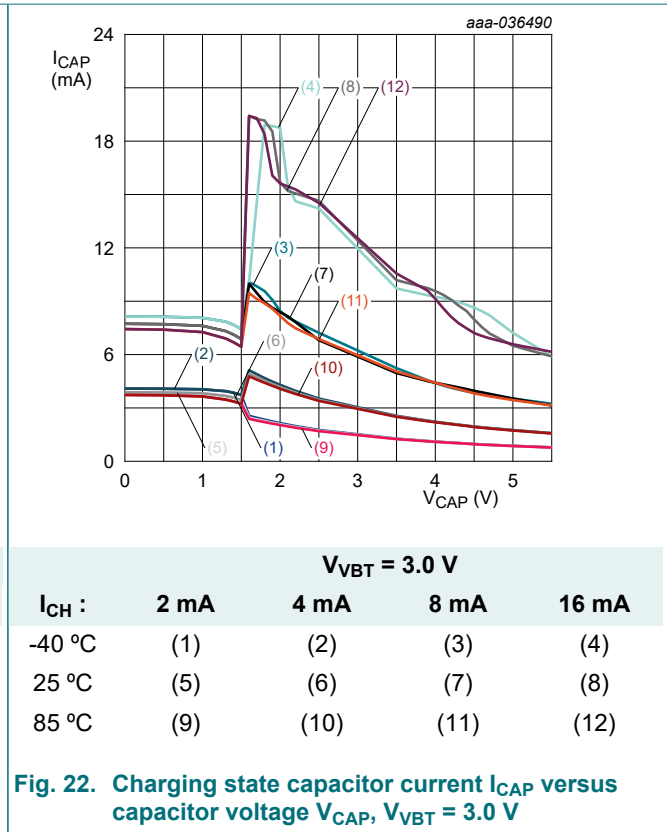
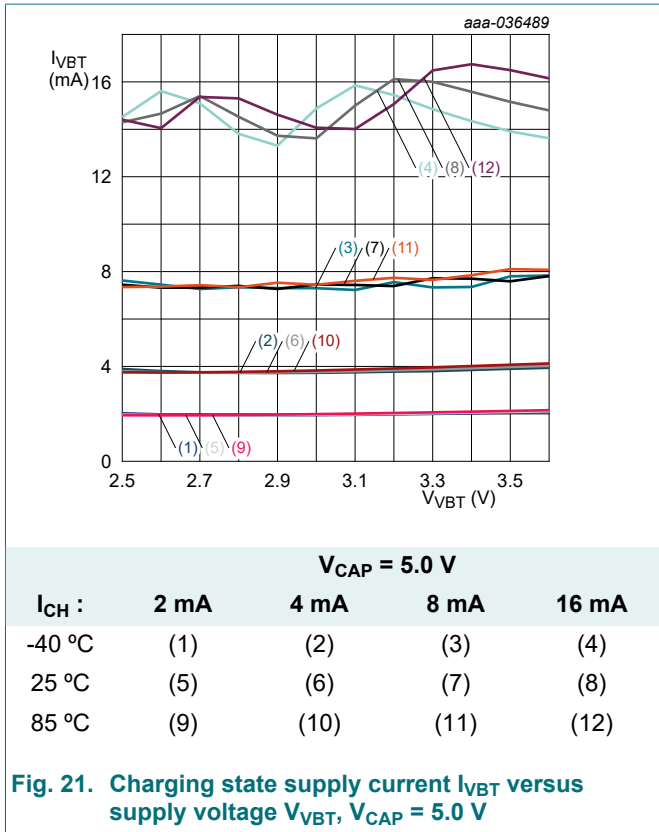
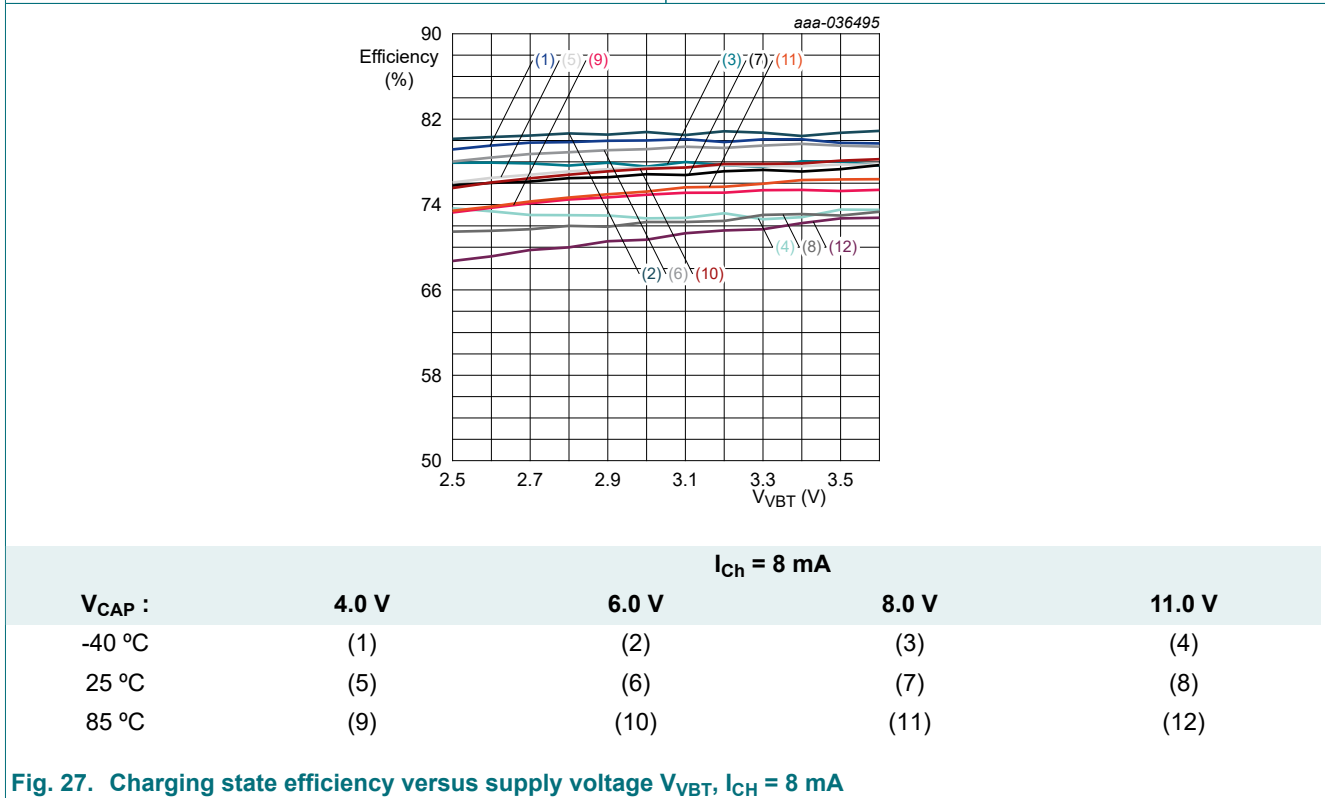
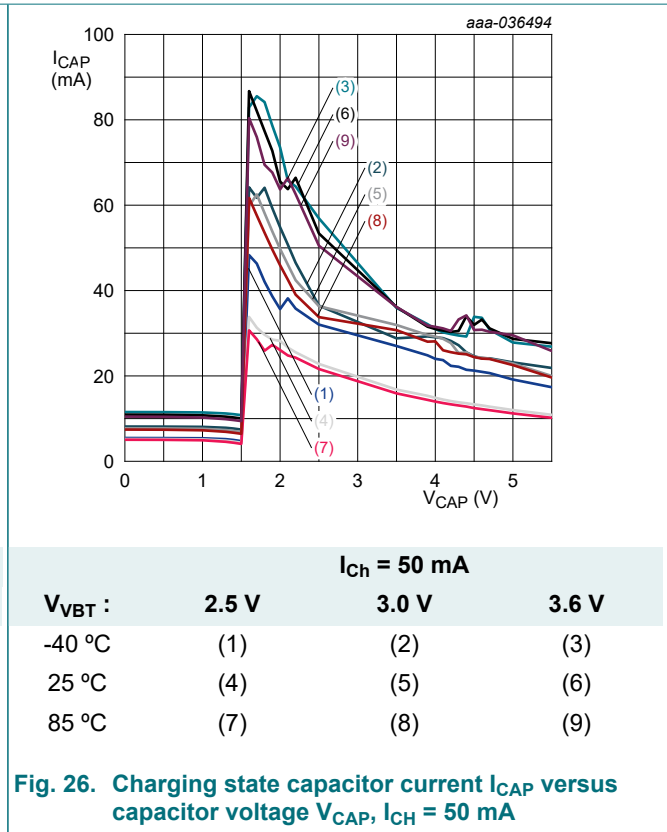
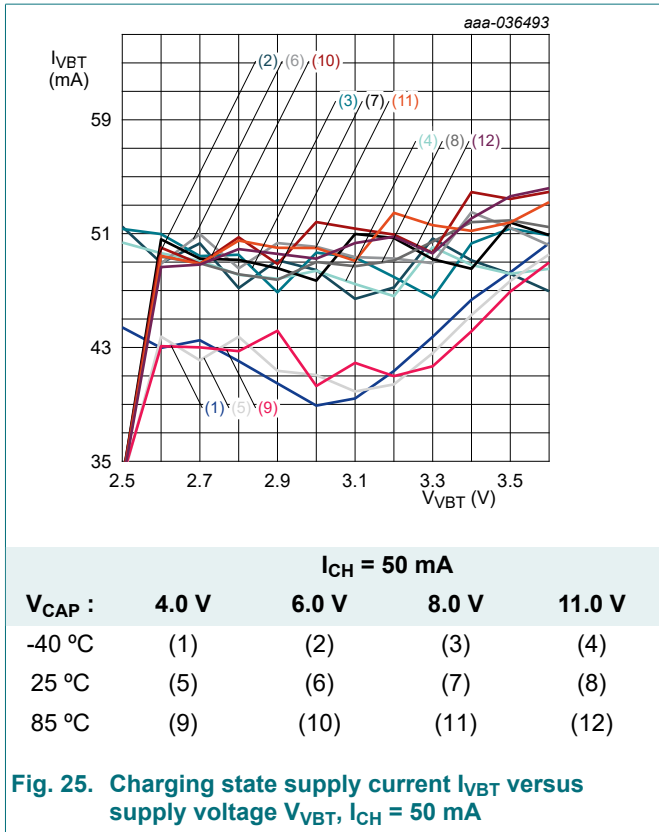
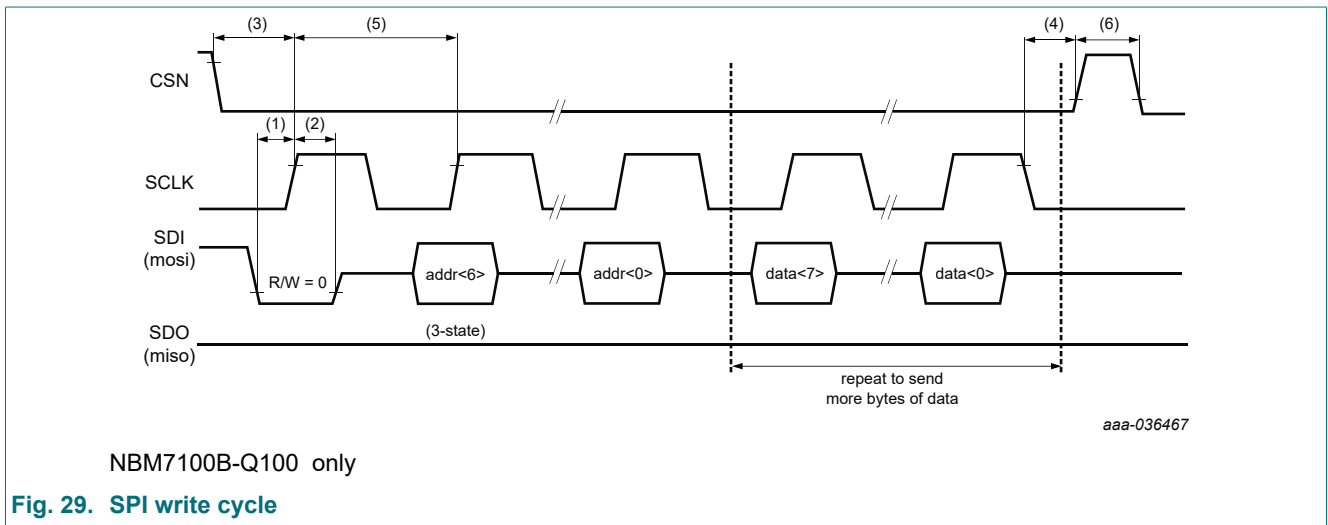
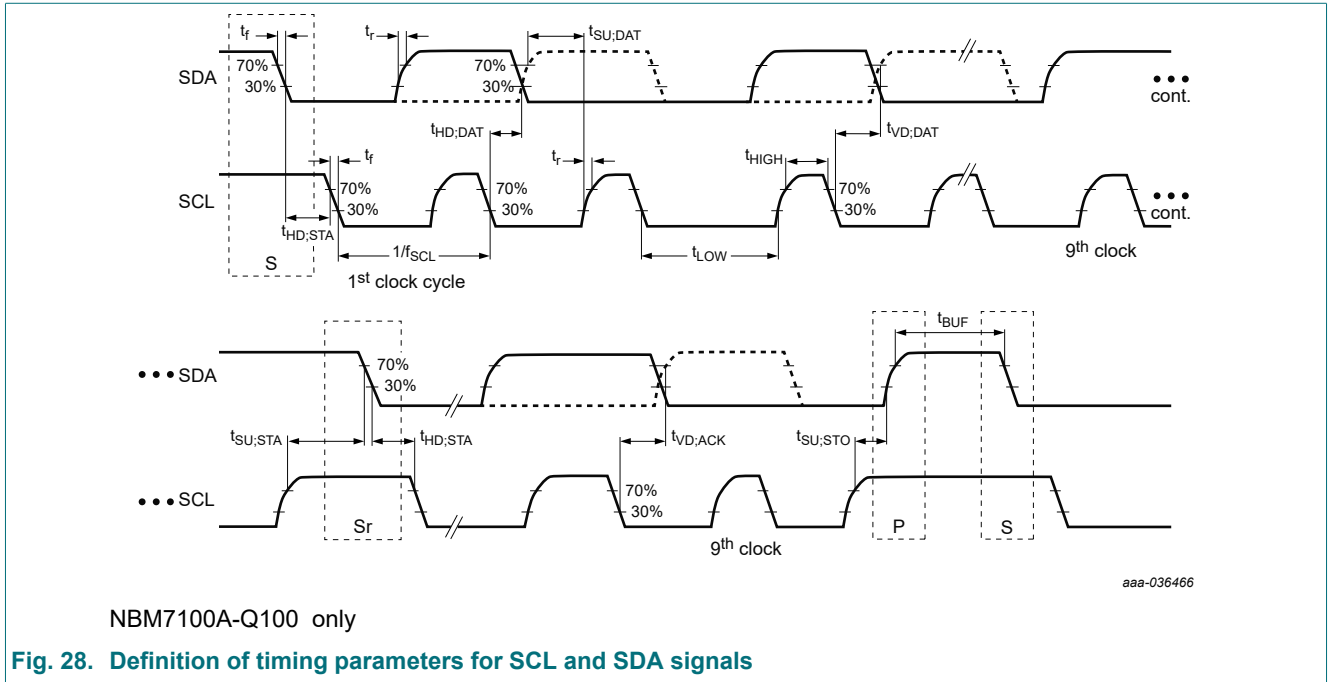

Fig. 20. Active state V_{VDH} regulation versus V_{CAP} , $V_{VDH} = V_{SET} = 3.6\text{ V}$





7.9. Timing diagrams



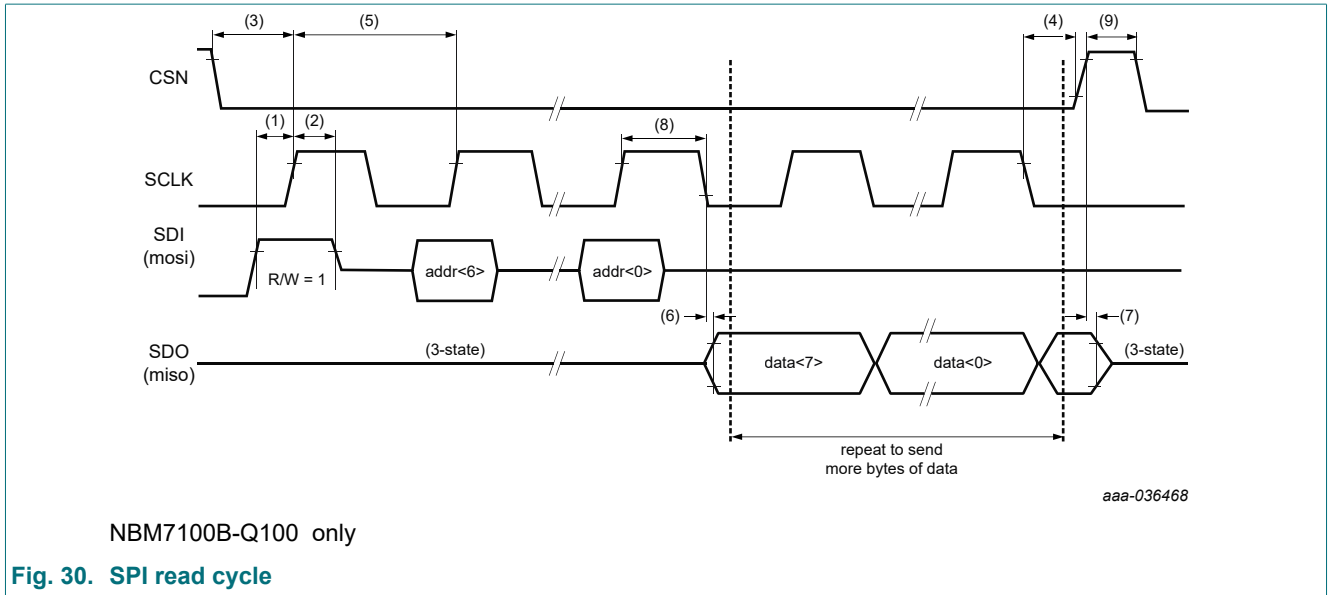

7.10. Test circuits

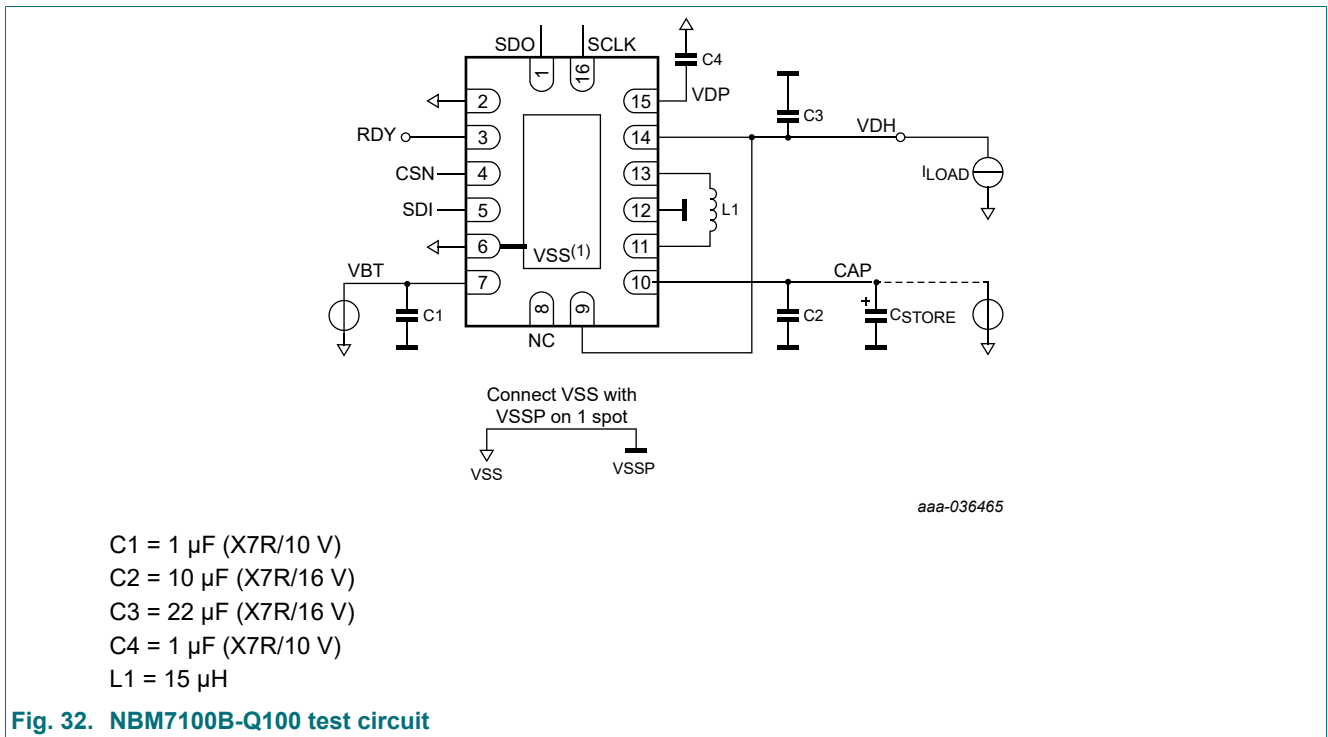
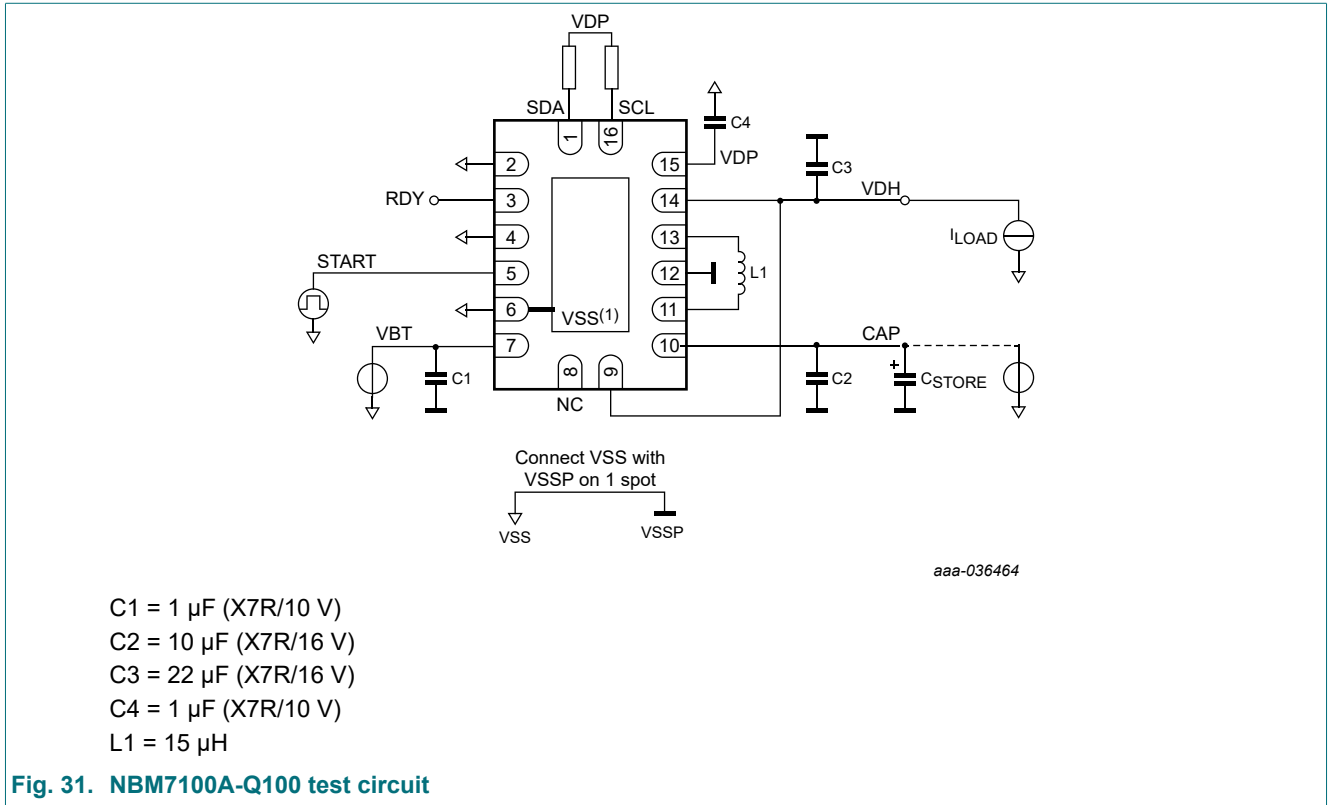

8. Detailed description

8.1. Functional diagram

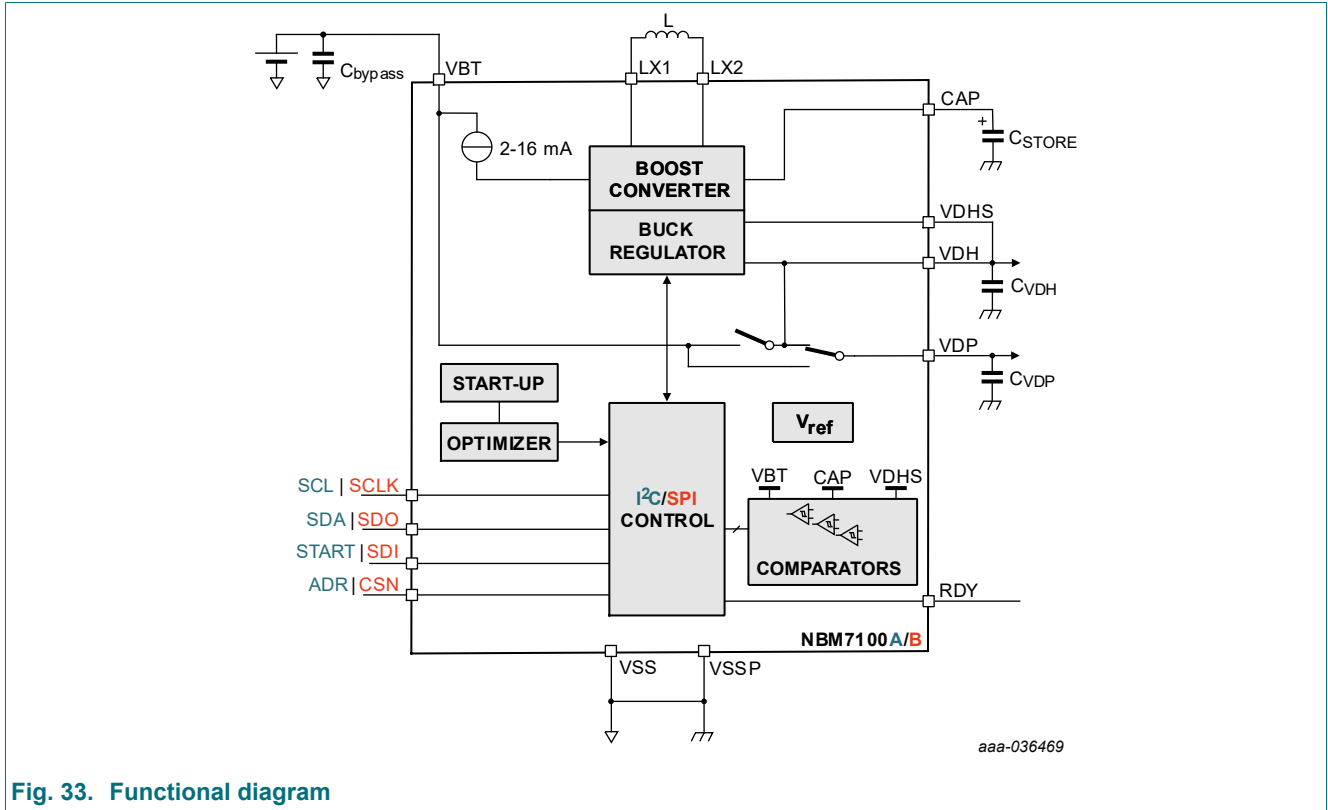

8.2. Overview

The NBM7100A/B-Q100 is a battery energy management device designed to maximize usable capacity from non-rechargeable, primary batteries when used in low-voltage, low-power applications requiring burst current loads.

Battery capacity, expressed as milliampere-hours (mAh) is the amount of current withdrawn from a cell multiplied times the number of hours the cell can deliver the current to a specific end-point voltage, often referred to as the cut-off voltage. Cell capacity varies in response to the applied load and temperature. The shape of the curve depends upon battery construction and chemistry. Primary battery data sheets provide characteristic curves to aid the system designer in estimating the life of the cell under load and temperature conditions. Illustrative, hypothetical characteristic curves are shown in [Table 15](#). [Fig. 34](#) highlights the effect of temperature on primary cell capacity and [Fig. 35](#) shows the result of increasing constant current loading on capacity. The diagrams illustrate how usable battery capacity is adversely affected by both its operating environment and operating condition.

Table 15. Example primary battery characteristics

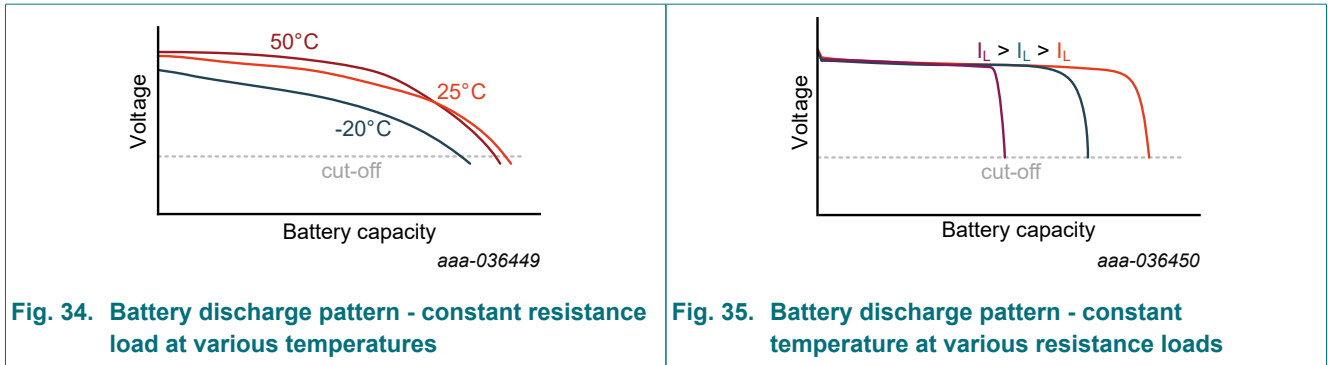

The NBM7100A/B-Q100 uses two stages of high efficiency DC-DC conversion to buffer the battery from high current, short duration load transients. The first stage conversion, or charge cycle, is initiated in advance of a period of heavy load current. During the charge cycle, energy is transferred from the battery to an external storage capacitor at constant current from the battery. Once charged, the second stage of DC-DC conversion, or active cycle, transfers energy from the storage capacitor to a fixed voltage output capable of supplying high load current. The peak current drawn from the battery remains very low during the charge cycle and is minimal in the active cycle decreasing the repetitive stress on the battery and maximizing the usable capacity. When not operating in charge or active state, the NBM7100A/B enters a low quiescent current standby state. An intelligent learning algorithm monitors the load pulse characteristics and optimizes energy transfer to the capacitor.

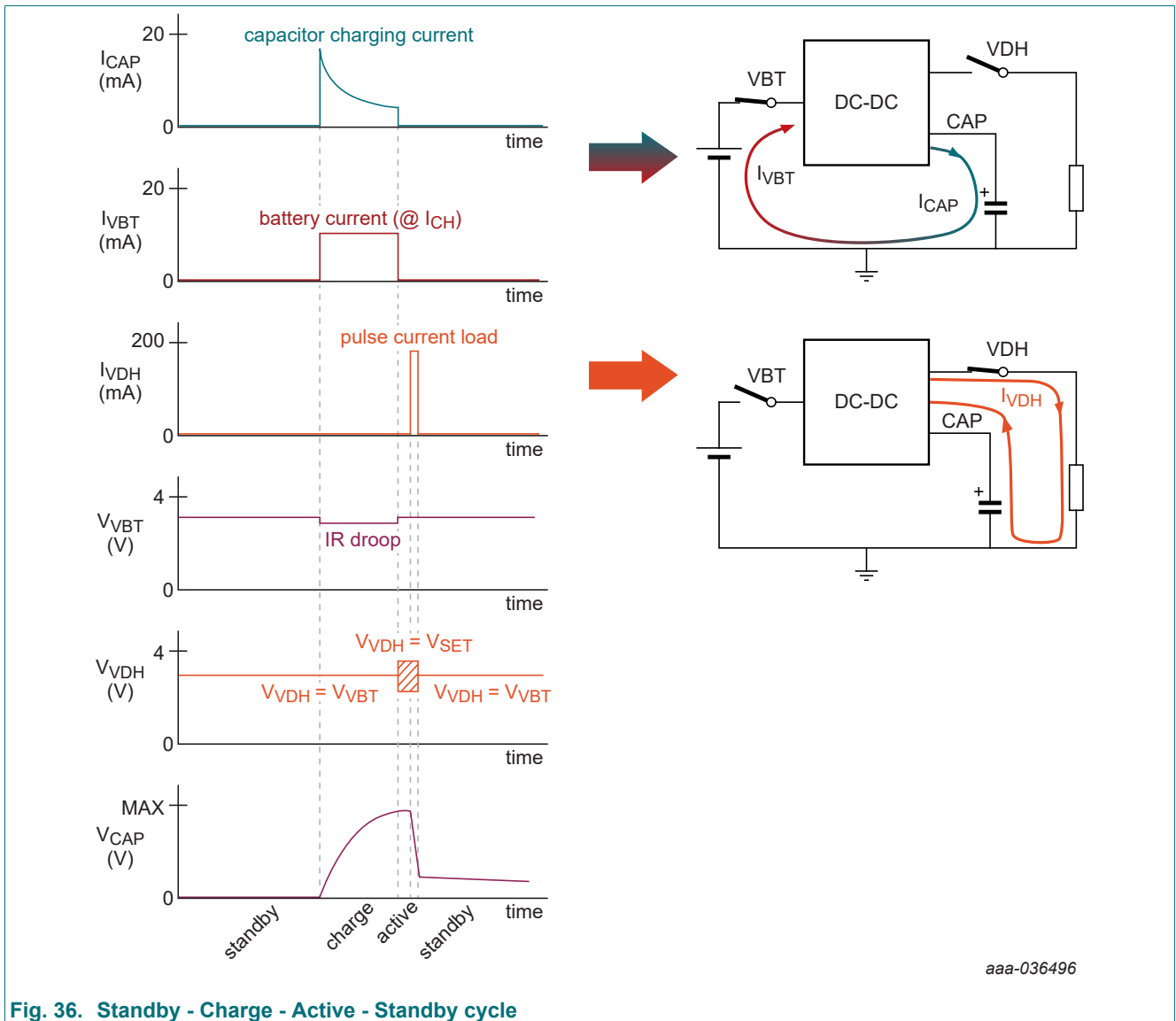

The NBM7100A/B-Q100 is ideal for applications supplied from non-rechargeable, primary cell batteries with high internal impedance. Common examples include: lithium metal primary batteries such as 3V lithium manganese dioxide (LiMnO₂ - example "CR 2032 coin cell"), 3.6 V lithium thionyl chloride (Li-SOCl₂ - example "LS 14250" ½ AA), and emerging paper printed types. Lithium metal batteries are commonly selected for low-voltage, low-power electronics due to their superior energy density (Wh/kg) and long storage life. A comparison of lithium batteries is shown in [Table 16](#). The 2 × "AA" alkaline column is included for reference.

Table 16. Basic primary cell battery comparison

	LiMnO ₂ CR 2032	Li-SOCl ₂ LS 14250 (½ AA)	2 × "AA" Alkaline
open circuit voltage (BoL)	3 V	3.6 V	3 V
energy density	280 Wh/kg	500 Wh/kg	200 Wh/kg
capacity	240 mAh (0.2 mA)	1200 mAh (0.5 mA)	~ 4000 mAh (@ 250 mA) (2 × 2000mAh)
cut-off voltage	2 V	2 V	1.6 V (2 × 0.8 V)
shelf life	10+ years	10+ years	5-7 years
operating temperature	-30 to 60°C	-55 to 85°C	0 to 60°C
internal resistance [1]	10 Ω (BoL) 70 Ω (EoL)	10 Ω (BoL) 70 Ω (EoL)	< 1 Ω (over lifetime)

[1] BoL: Beginning of life
EoL: End of life

Many battery powered electronic loads do not operate with a constant current drain from the primary cell, rather are made of short periods of relatively high current followed by much longer periods of very low current. The resulting average current is very low, often only a few 10s of μA. It is complicated to accurately estimate the effect variable loading on battery capacity, but important to realize the usable capacity will be lower than the average indicates as the chemical reaction rate needed to support a load pulse of t_{ON} is higher than that required in the t_{OFF} condition scales non-linearly.

[Fig. 37](#) depicts a pulsed load having a peak current I_{PK} and a background (continuous) current drain of I_{BKG}. During the load pulse, the battery voltage droops for two reasons [Fig. 38](#): 1) I × R drop due to the pulsed current and 2) the chemical reaction rate in response to the load step. When the I_{PK} is released and the battery loading returns to I_{BKG}, the battery voltage returns close to its value before the load pulse was applied. Over time and repetitive pulses, battery chemicals are depleted and the starting and recovery voltages decrease.

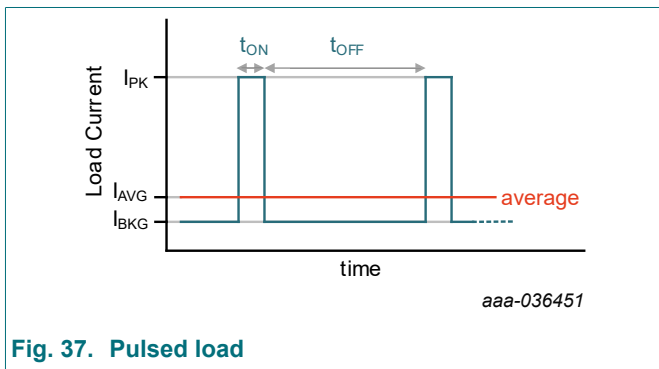

Fig. 37. Pulsed load

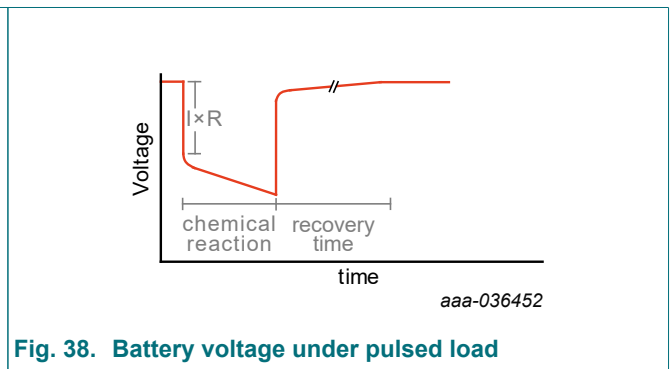

Fig. 38. Battery voltage under pulsed load

Fig. 39 compares a continuous current drain, I_{AVG} equal to the duty cycle average of I_{PK} and I_{BKG} to the piecewise components of I_{PK} and I_{BKG} to illustrate battery capacity under pulsed conditions are not equivalent to a steady-state current drain of an average equivalent load. Maximum battery life is achieved when the battery is exposed to low DC current, ideally < 10 mA.

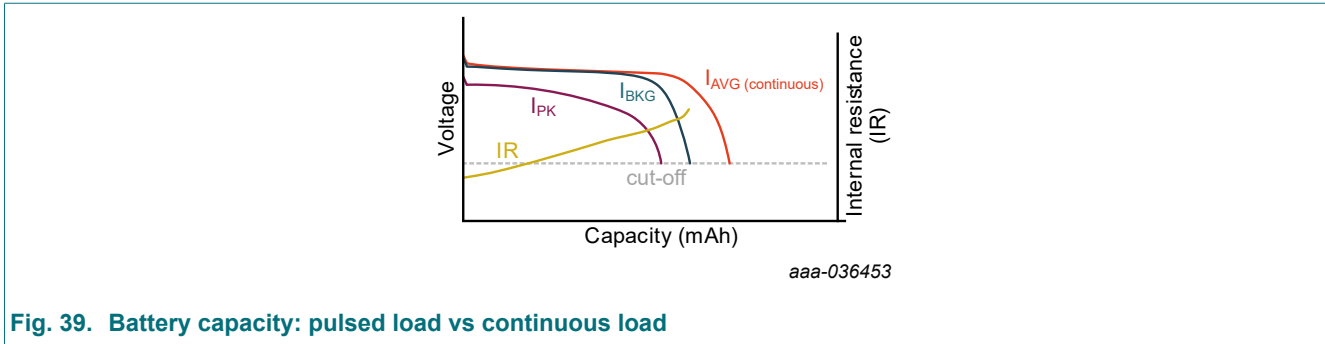

Fig. 39. Battery capacity: pulsed load vs continuous load

8.3. Operating modes

The NBM7100-Q100 has three operating modes:

1. Continuous mode
2. On-demand mode
3. Auto mode (NBM7100A-Q100 only)

When the NBM7100A/B-Q100 is in one of the three operating modes, the device may transition between different [States of operation](#): Standby, Charge, or Active. The Standby state is not an Operating mode, but is represented in [Fig. 40](#) for clarity of device behavior while not in one of the three operating modes.

8.3.1. Mode overview

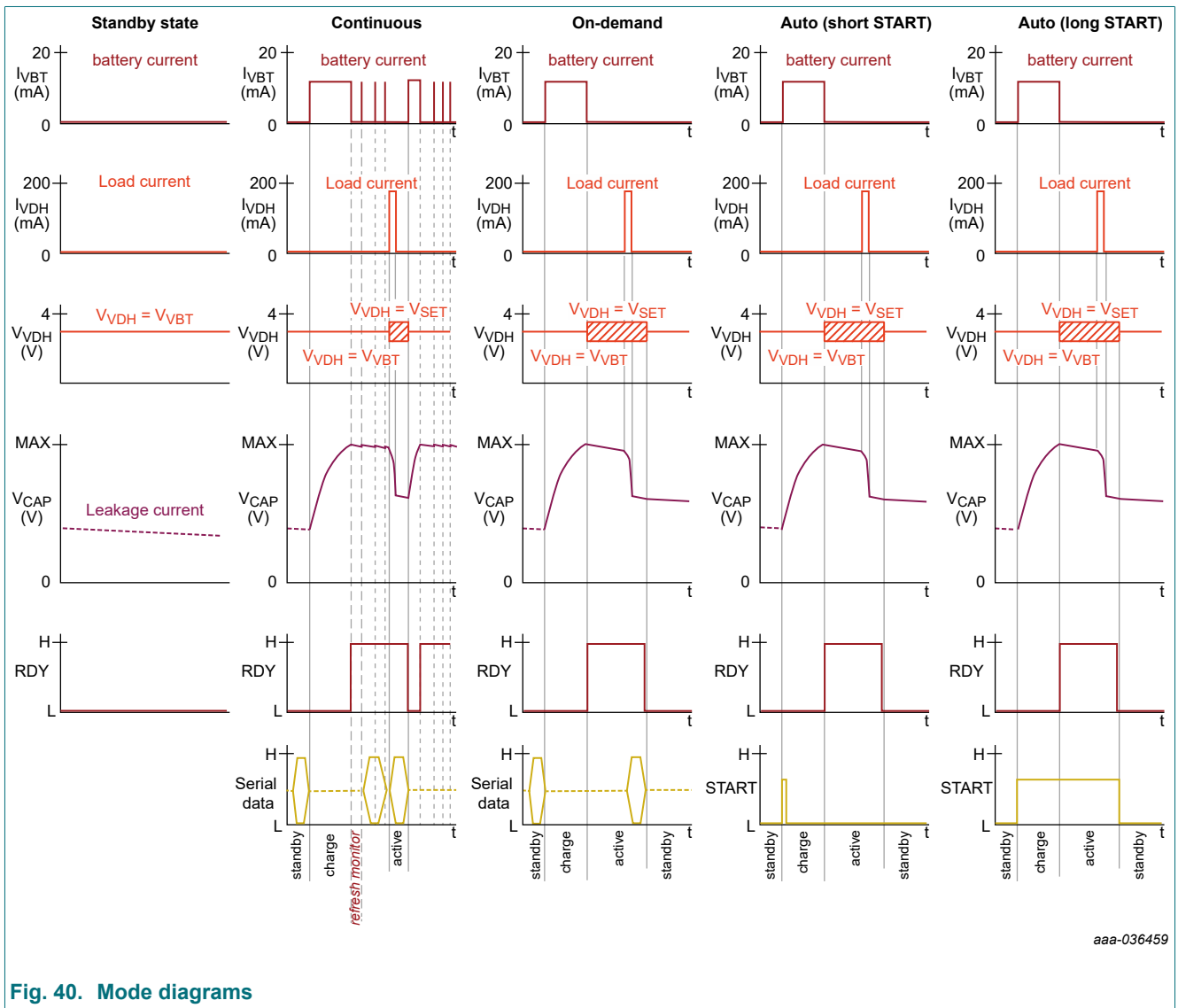

Fig. 40. Mode diagrams

Mode Controls

Table 17. *command* and *set3* Registers - Mode control

Register 8 0x08 (write)	Code (bin)	Function	Remark
bit [0] <i>eod</i> (enable On-demand)	0	off	-
	1	on	-
bit [1] <i>ecm</i> (enable Continuous mode)	0	off	-
	1	on	-
bit [2] <i>act</i> (force Active state)	0	off	-
	1	on	force active
bit [3] <i>rstpf</i> (reset optimizer)	0	-	-
	1	reset	reset optimizer result of active profile prof[5:0]
Register 11 (write)			
bit [7] <i>automode</i>	0	off	default for NBM7100B-Q100 version [1]
	1	on	default for NBM7100A-Q100 version

[1] NBM7100B-Q100 cannot be written to 1.

8.3.2. Continuous mode

Continuous mode is intended for applications requiring instant pulse load capability. It is initiated by setting the ECM bit 0x08[1] (see [Mode controls](#)). In Continuous mode, the external storage capacitor is charged and the DC-DC converter is idled. The CAP pin voltage is "monitored," and if the capacitor voltage, V_{CAP} as indicated in [vcap](#) drops below the end of charge V_{FIX} as programmed in [vfix](#) the DC-DC is automatically enabled to "refresh" the capacitor to the target V_{FIX} voltage. When an Active command is received then the stored energy in the capacitor is immediately available at full power as a regulated supply voltage at pin VDH. The storage capacitor will get recharged automatically after the device has delivered its energy pulse to the load. The RDY signal indicates when the storage capacitor has been charged or recharged to V_{FIX} . Active state and recharging can be toggled as needed. The device returns to Standby mode by resetting both the ECM and ACT bits.

8.3.3. On-demand mode

On-demand mode is initiated by setting *eod* bit 0x08[0] (see [Mode controls](#)). This mode is intended to maximize battery lifetime in low duty cycle applications where the system is in sleep-mode most of the time. In this mode the energy is first extracted from the battery and stored in a capacitor (C_{store}) connected to the CAP pin. The stored energy is then made available at full power as a regulated supply voltage at pin VDH. The RDY output indicates when the output VDH is ready to deliver power. On-demand mode is ended by resetting the *eod* and *act* bits.

8.3.4. Auto mode (NBM7100A-Q100 only)

Auto mode utilizes the START pin to set and reset the *eod* bit without requiring the serial bus. One cycle is initiated by a rising edge on the START pin. When charging is finished the Active state will begin automatically and the RDY pin will go high to confirm that the VDH pin is regulating to V_{SET} and ready to deliver full power. The Auto mode can be enabled or disabled by the *automode* bit 0x11[7]. To prevent unintended Auto mode triggering due to a floating input condition, the START pin should be connected to VSS via a pull-down resistor. The pull-down resistor should be sized appropriately for the I_{OH} of the external microcontroller driving the pin.

In Auto mode, there are two ways to define the end of the Active state:

1. Short pulse on START: From standby mode, a short pulse ($\geq 10 \mu s$) is applied on the START pin. A charge cycle initiates followed by automatic transition to Active state. A short START pulse is defined as the time the START pin is driven high until Active state is reached at the conclusion of the Charge state. $10 \mu s \leq t_{START(short)} \leq time_{(Charge\ state\ ends)}$ as indicated

by the *rdy* bit or the *RDY pin*. The Active state automatically ends when the combined VDP and VDH load current is below I_{NL} for approximately T_{NL} .

- Long pulse on START: From standby mode, the START pin is driven high and maintained high until the Active cycle begins as indicated by a high transition on the RDY pin. The Active state is ended when the START pin is driven low. When a long START pulse is initiated, the START pin should be maintained high until the high current load pulse on VDH is concluded.

Note: in case the START pin is set low during the charge state, this will be interpreted as a short pulse.

At power-on, the default settings of the NBM7100A-Q100 are:

- Auto mode is ON (see [Mode controls](#))
 - $V_{SET} = 3.0\text{ V}$
 - $I_{ch} = 8\text{ mA}$
 - Profile number = 1 (Optimization is active for profile 1)
- When other settings are required, a serial bus command is required to change the default settings.

The NBM7100A-Q100 can be switched between Continuous mode, On-demand mode and Auto mode at any time.

8.4. Feature description

8.4.1. Chip control

Refer to [functional diagram](#). The chip control consists of the device [state machine](#); [serial bus interface](#); status, configuration and control [registers](#); the [optimizer](#) engine, and [fuel gauge](#) functions. It enables and disables peripheral analog blocks as required to execute the [state machine](#).

8.4.1.1. Serial bus

The NBM7100A/B-Q100 is controlled using a serial bus interface. Reading or writing of settings may be performed approximately 20 ms after power-on reset is cleared and device start-up completed. Initiating communication while the device is in startup may result in register errors. Internal registers allow control of the Standby-Charge-Active cycling process (On-demand mode) or the Charge-Active cycling process (Continuous mode), reading of device status indications, and adjustment of device operating parameters.

8.4.1.1.1. NBM7100A-Q100 I²C interface

The NBM7100A-Q100 is protocol compatible to Fast Mode Plus I²C interface (1 MHz). The NBM7100A-Q100 is a slave device and has two programmable slave addresses. Each I²C transaction requires a register address followed by one or more data bytes. The register address is auto-incremented after each data-byte.

For reading data, the selection of the register address and the reading of the data must occur in one single transaction. Switching from write to read mode (or vice versa) must be done with a repeated Start condition. Register selection is always cleared after a STOP (P) command. If no register is selected while reading, the status register will appear as the first data byte.

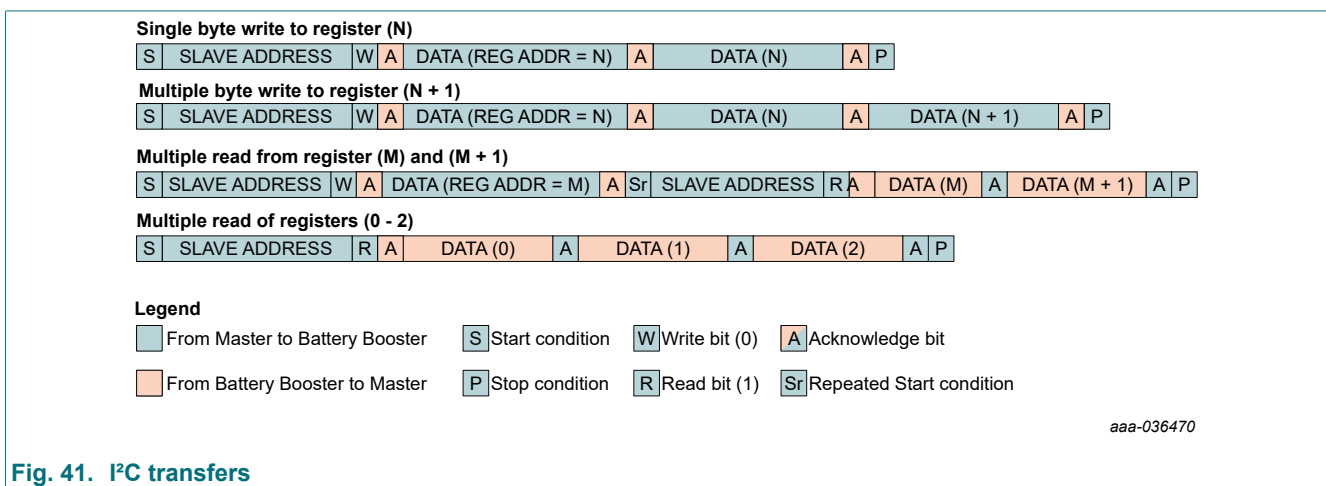

Fig. 41. I²C transfers

Two I²C slave addresses are available for the NBM7100A :

Table 18. I²C addresses

ADR pin	I ² C Slave address
0	0x2E (010 1110 R/Wn)
1	0x2F (010 1111 R/Wn)

8.4.1.1.2. NBM7100B-Q100 Serial Peripheral Interface (SPI)

The NBM7100B-Q100 supports bidirectional communication with a master system controller (MCU) via a 4-wire SPI mode 0 compatible serial communication interface. It is a transmit/receive slave-only interface. The master device initiates data transfers on the bus and must generate the Clock (SCLK) and Chip Select Not (CSN) signals. The data input is SDI (MOSI), and the data output is SDO (MISO). Each transmission starts with the falling edge of CSN and ends with the rising edge. During a transmission, commands and data are controlled by SCLK and CSN according to the following rules:

- Commands and data are shifted MSB first, LSB last.
- Input bit is sampled at the rising edge of SCLK.
- In read mode, data bits are shifted out at the falling edge of SCLK. After the device has been selected with the falling edge of CSN, the first byte defines data direction and register address. MSB = 1 for Read, or MSB = 0 for Write, followed by 7-bits for the address in the register space.
- The rising edge of CSN ends all data transfer, terminating any previous command and clears the address pointers.
- If an invalid command is received, no data is shifted out of the circuit until the falling edge of CSN. This reinitializes the serial communication.
- Data that is written to the NBM7100B-Q100 immediately follows the first address byte.
- Data that is read from the device at the rising edge of SCLK immediately follows the last bit of the address byte.
- Maximum SCLK clock frequency is 4 MHz (500 Kbyte/s)
- An SPI command can be followed by multiple data bytes within one transmission. The register address pointer is auto-incremented.
- SPI mode 0 means that the parameters Clock Polarity (CPOL) and the Clock Phase (CPHA) are both 0.

8.4.1.1.3. Device register overview

Refer to the [register map](#). Short description of the registers and their functions follows. Additional details can be found in the respective feature sections.

setx registers [0x09:0x13] configure the active mode regulated output voltage [vset\[3:0\]](#) (V_{DH}); the charge state target voltage [vfix\[3:0\]](#), V_{FIX} and maximum voltage for the storage capacitor [vcapmax](#) ($V_{CAP(MAX)}$); the capacitor charging current [ich\[2:0\]](#) (I_{CH}); low voltage monitor thresholds for battery [vmin\[2:0\]](#) (V_{MIN}), and capacitor early warning [vew\[3:0\]](#) (V_{EW}); enable/disable the internal power path switch between V_{DP} and V_{DH} [vdhiz](#); enable/disable auto mode [automode](#); and adjust the voltage margin of the optimizer function [opt_marg\[1:0\]](#).

status register [0x00] provides indication the capacitor is charged and is the device is ready ([rdy](#)) to support a high current load on the V_{DH} pin. The [RDY](#) output pin reflects the present status of the [rdy](#) bit without requiring serial bus data transactions. Monitor alarms for low battery, V_{MIN} , ([lowbat](#)); low capacitor voltage, V_{EW} , early warning ([ew](#)) and low output voltage in the Active state, V_{DH} ([alarm](#)) provide a view of device and system conditions.

command register [0x08] is used to set the device operating modes: enable On-demand, enable Continuous, and Active. The MSBs of [0x08] and LSBs of [0x07] are used to set the optimizer profile number [prof\[5:0\]](#) (1d to 63d). Each profile setting can be used optimize the energy transfer of one unique repetitive load condition (see [Section 8.4.5](#)). The least significant bits of the optimizer profile setting are deliberately located in the command register to facilitate a single write transaction for the first 14 settings (1d to 14d).

vcap register [0x05] is utilized in the charge and active states to provide near real-time indication of storage capacitor voltage. The registers are not updated in the standby state. The [vchend](#) register is a translated digital mapping of the target V_{CAP} voltage obtained from [vfix\[3:0\]](#) in [0x08] when the [prof\[5:0\]](#) bits are all reset [0h], or [voptx\[3:0\]](#) hidden registers used by the optimizer to set the target capacitor charging voltage threshold associated with each profile.

chengy registers [0x01:0x04] provide indication of the charge removed from the battery following one enable On-demand or upon completion of a Continuous mode cycle. The registers are reset before the charging cycle begins and should be read and accumulated by an external microcontroller while the device is in the active or standby state.

8.4.1.2. The ready (RDY) output signal and rdy bit

The RDY signal is driven high indicating that the NBM7100A/B-Q100 is ready to provide full power to its load. It can serve as an interrupt signal to a connected microcontroller. Its behavior is different (see below) in On-demand mode than it is in Continuous mode. The *rdy* bit in 0x00[0] follows the RDY signal.

RDY in On-demand mode

The RDY signal will go high when the capacitor charge level is reached, and the VDH output voltage is regulating to V_{SET}.

The RDY signal will go low if:

- The *eod* bit is reset (see [Mode controls](#)) or
- The storage capacitor is depleted.

If Early Warning is activated and the voltage at the storage capacitor drops below V_{EW} (see [capacitor early warning voltage](#)), then the RDY signal will pulse low for *t_{EW}*, then resume high state until one of the above On-demand mode conditions is met.

RDY in Continuous mode

The RDY signal will go high when the voltage at pin CAP has reached V_{FIX}.

The RDY signal will go low if:

- The *act* bit is reset (see [Mode controls](#)) or
- The storage capacitor is depleted.

If Early Warning is activated and the voltage at the storage capacitor drops below V_{EW} (see [capacitor early warning voltage](#)), then the RDY signal will pulse low for *t_{EW}*, then resume high state until one of the above Continuous mode conditions is met..

8.4.2. States of operation

The NBM7100A/B-Q100 has four main states of operation as shown in [Table 19](#).

Table 19. States of operation

Operating state	Continuous mode	On-demand mode	Auto mode
<p>aaa-036463</p>	(1) <i>ecm</i> bit set 010 (2) <i>act</i> bit set 110 (3) <i>act</i> bit reset 010 from Charge or Active return to Standby: (4) Reset <i>ecm</i> and <i>act</i> 000	(1) <i>eod</i> bit set 001 (2) Charge ready 101 (<i>occurs autonomously</i>) (4) <i>eod</i> bit reset 000	(1) 10 μs start pulse 001 (2) Charge ready 101 (4) no_load current 000
		(1) <i>eod</i> bit set 001 (2) Force active 101 (before Charge ready) (3) Continue charge 001 (2) Charge ready 101 (<i>occurs autonomously</i>) (4) EOD bit reset 000	(1) START = 1 001 (2) Charge ready 101 (4) START = 0 000
	The three digits represent the value of the bits (<i>act</i> ; <i>ecm</i> ; <i>eod</i>) in register 8 (see Section 10.2), either controlled through a serial bus command, or (<i>in bold italic</i>) changed by the internal logic.		

8.4.2.1. Startup state

When a battery or other voltage source is sensed at the VBT pin and the sensed voltage is higher than V_{POR} level, internal power switches connect VBT and outputs VDP and VDH (See [POR VBT fast ramp](#)). Approximately 20 ms after start-up, the Standby state is entered.

Note: The [register map](#) indicates the default state of all bits at startup. Reading or writing to the serial bus during the Startup state may cause corruption of the non-volatile memory. Serial bus transactions should not be initiated until approximately 20 ms after $V_{VBT} > V_{POR}$ when the device has entered the Standby state.

8.4.2.2. Standby state

The Standby state is a low power operating condition where the quiescent current consumption is almost negligible; the serial port is active and ready to receive commands; and the VBT to VDP switch is enabled.

In the Standby state, the device is inactive. The supply current drawn from the battery is very low, I_{Q_STB} and the device is waiting for a serial bus command or START command (NBM7100A-Q100). While the device is in Standby state, device settings can be programmed. For example: [maximum storage voltage](#), $V_{CAP(MAX)}$; the [charging current](#), I_{CH} ; and the active mode VDH [output voltage](#), V_{SET} .

The VBT to VDH switch is enabled at POR by default. Alternatively, for a high-impedance VDH output in the Standby and Charge states, set $vdhhiz = 1$ (see [VDH](#)).

The register settings are retained while supply voltage at VBT input is not interrupted.

The RDY output and [rdy](#) register bit is low in Standby state.

The chip will exit Standby and enter the Charge state by:

- the setting of [eod](#) (Enable On-demand) bit, or
- setting the [ecm](#) (Enable Continuous Mode) bit, or
- activation with the [START](#) pin (NBM7100A-Q100) with $automode = 1$.

8.4.2.3. Charge state

The DC-DC [boost converter](#) is enabled with VBT as the input and CAP as the output. The external storage capacitor is charged from VBT using constant current, I_{CH} , as set by the [ich\[3:0\]](#) bits in 0x10[7:5]. The *ich* bits provide 4 normal charging current settings and one high current (emergency) level. Using the lowest I_{CH} setting maximizes battery life at the expense of a long charging time.

In the Charge state, if V_{VBT} drops below the programmed VBT input minimum threshold, V_{MIN} as set by the [vmin\[2:0\]](#) bits in 0x10[2:0], the NBM7100A/B-Q100 pauses charging until VBT recovers above V_{MIN} at which point charging resumes. If VBT remains below the V_{MIN} threshold for more than 16 μ s, the [lowbat](#) alarm status bit will be set to indicate the battery may be nearing end of life.

[vmin\[2:0\]](#) is an aid for maintaining a minimum battery voltage. Battery voltage drop could be caused by multiple factors including, current consumed by other functions in the application connected directly to the battery, end of battery life, a low operating temperature or the formation of a passivation layer inside the battery (in case of Li-Thionyl batteries).

While above V_{MIN} , charging continues until the “End-of-charge” voltage is reached.

- **Fixed (optimizer disabled):** The “End-of-charge” voltage as set by [vfix](#) ([optimizer profile = 0](#))
- **Optimizer (enabled):** The “End-of-charge” voltage as set by [voptx](#) (hidden register location) as controlled by the [optimizer](#) ([optimizer profile \$\neq\$ 0](#))

The [vcapmax](#) bit in 0x12[4] defines, $V_{CAP(MAX)}$, the maximum storage capacitor voltage allowed during the Charge state. For safety reasons the value $V_{CAP(MAX)}$ will never be exceeded even if a higher fixed End-of-charge voltage is programmed.

The progress of charging the storage capacitor can be monitored by reading the [vcap](#) status register 0x05[4:0].

In On-demand mode, the device will automatically enter Active state after reaching the End-of-charge voltage.

In Continuous mode the device will stay in Charge state and the charge level of the capacitor will be maintained at the programmed level. This will compensate for any leakage from the storage capacitor. This charge maintenance uses minimal power from the battery.

8.4.2.4. Emergency charge state

The normal charge currents [ich\[3:0\]](#) = 0h, 1h, 2h, or 3h are intended to limit the battery current for optimal efficiency and battery lifetime. The lower the charge current, the longer the time to charge the storage capacitor. In cases where a shorter charge time prevails above battery lifetime, the emergency charge mode ([ich\[3:0\]](#) = 4h) is available. In emergency charge mode, the battery current is increased to 50 mA (typical). [vmin\[2:0\]](#) continues to function as described in [Charge state](#).

8.4.2.5. Active state

In the Active state both the VDP and VDH outputs are supplied from the integrated switching regulator using the storage capacitor as its energy source. In this state the current consumed by the NBM7100A/B-Q100 from the battery is very low, I_{Q_ACT} . The output voltage (VDP and VDH) is determined by the value programmed in the **set1** register using the [vset\[3:0\]](#) (V_{SET}) bits.

On-demand mode: The Active state is entered automatically after charging has been completed. The Active state can also be initiated prior to completion of the charge cycle (force active) by setting the [act](#) bit high. Active state ends by resetting the [eod](#) bit and returns to the Standby state.

Continuous mode: The Active state is entered at any time by setting the [act](#) bit. Active state ends by resetting the [act](#) bit and returns to the Charge state. Resetting the [ecm](#) and [act](#) bits returns the device to Standby.

8.4.2.6. Capacitor input voltage Early Warning alarm

In the Active state the storage capacitor is the energy source for the DC-DC converter. As the capacitor is discharged by the load its voltage drops. A programmable early warning alarm is available to alert the system when V_{CAP} drops below the V_{EW} threshold set by the [vew\[3:0\]](#) bits indicating a limited amount of energy is remains in the capacitor. The [eew](#) bit enables or disables the alarm indication. The condition of the alarm is indicated by the [ew](#) bit in the status register 0x00[6]. When the [ew](#) bit goes high, the [RDY](#) pin pulses low for t_{EW} providing two mechanisms for the system to receive an indication the alarm has triggered. The power on default state for [eew](#) is disabled.

8.4.2.7. VDH output voltage alarm

In the Active state, if the load current exceeds the capability of the regulator, the VDH voltage may drop below the programmed target voltage, V_{SET} triggering the VDH alarm. The condition of the alarm is indicated by the [alarm](#) bit in the status register 0x00[5]. When the [alarm](#) bit is set, the [RDY](#) pin is driven low providing dual mechanisms for the system to receive the indication. If the load current is reduced, VDH may recover to V_{SET} before the Active state concludes; however, the [alarm](#) bit and [RDY](#) pin low indications will not reset until the next Charge state is initiated.

The maximum load current depends on the operating point of the DC-DC converter in the Active state: capacitor voltage (input supply to the DC-DC); the programmed VDH voltage V_{SET} (output of the DC-DC); external components ratings and tolerances; and the ambient temperature. Some typical characteristics are given in [Application curves](#).

8.4.3. DC-DC converter

The NBM7100-Q100 integrates a variation of a classical peak-current mode control "4-switch buck-boost" with a fixed frequency of 1 MHz. The DC/DC converter operates with discontinuous conduction mode for light loads and transitions to continuous conduction mode as the load current increases. Refer to [Fig. 42](#).

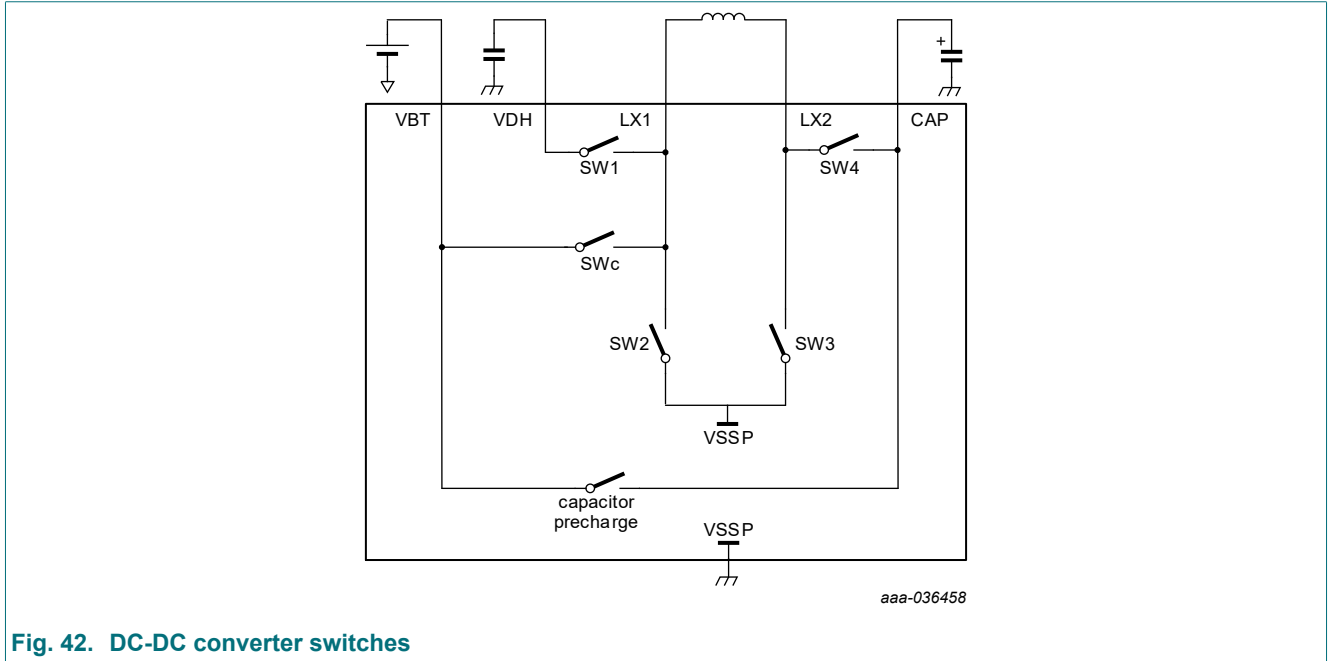

Fig. 42. DC-DC converter switches

In the charge state when $V_{CAP} < 1.6$ V, the storage capacitor is initially charged at low current via the capacitor precharge switch.

In the Charge state when $V_{CAP} > 1.6$ V, the DC-DC converter operates in boost mode to draw constant programmed charging current (I_{CH}) from the battery and charge the energy storage capacitor connect to the CAP pin.

The charging transition threshold can be seen in the [typical characteristics](#) section of the datasheet in the charging state capacitor current I_{CAP} versus capacitor voltage, V_{CAP} plots.

Boost mode (Charge)

- Primary phase: SWc and SW3 are ON
- Secondary phase: SW2 and SW4 are ON

In the Active state, the dc/dc converter uses the energy available in the storage capacitor to deliver a regulated output (V_{SET}) on the V_{DH} pin capable of supporting pulsed current loads.

Buck mode (Active)

- Primary phase: SW1 and SW4 are ON
- Secondary phase: SW3 and SW4 are ON

8.4.4. VDP and VDH output configuration

Fig. 43 provides a simplified representation of the internal power switches within the NBM7100A/B-Q100 devices.

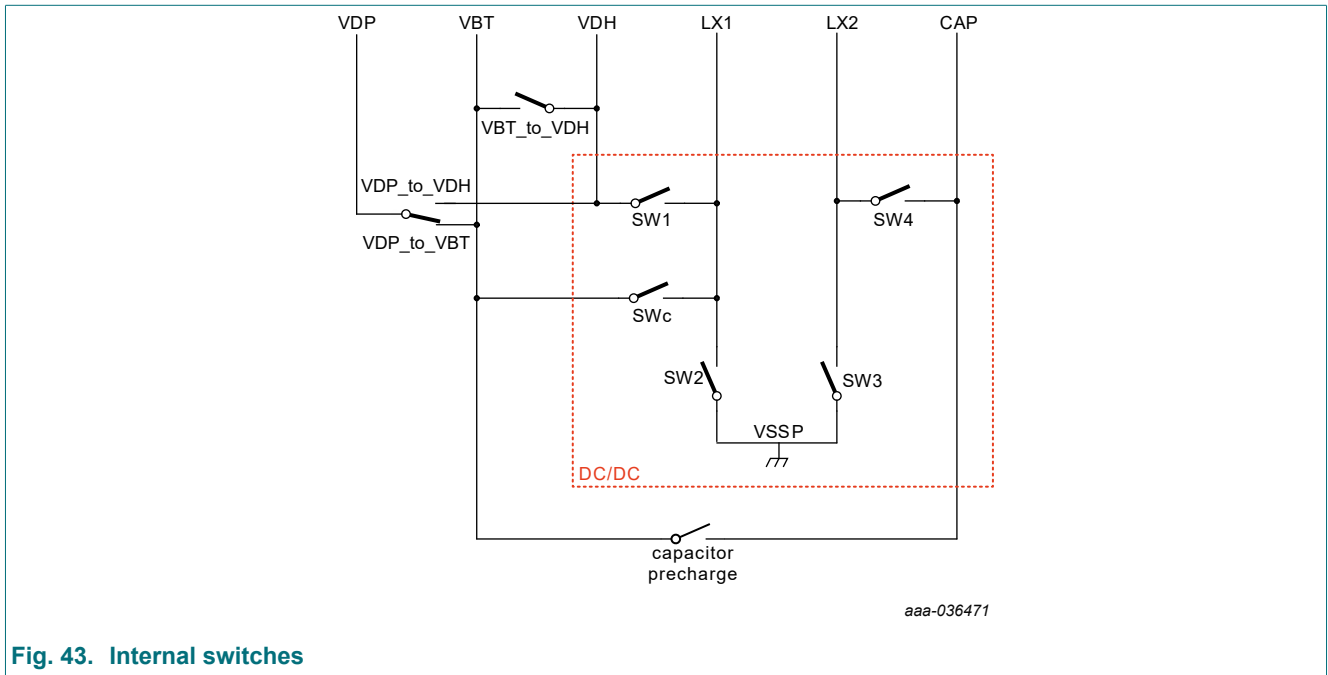

Fig. 43. Internal switches

8.4.4.1. VDP

VDP is a 'permanent' supply output pin. It is internally connected to VBT in the Standby and Charge states via the VBT_to_VDP switch. In the active state, VBT connects to VDH via the VBT_to_VDH switch. It provides power to 'always on' system loads (e.g. host microcontroller core and I/O). Due to the variable range of output voltages between VBT and the regulated VDH, care should be taken to ensure loads connected to the VDP pin will not be subjected unintended over-voltage or under-voltage conditions.

The VDP pin should be connected to a bypass capacitor. See [Recommended components](#).

8.4.4.2. VDH

The *vdhhiz* bit 0x10[4] is 0b upon entry into the Standby state following POR, connecting VBT to VDH. Unless the *vdhhiz* is set via the serial interface, VDH pin remains internally connected to VBT in all *states of operation* except the Active state.

In the Active state, VDH supplies a regulated output voltage according to *vset*[3:0] in 0x09[3:0]. [Table 20](#) summarizes the device default switch connections.

Table 20. VDP and VDH operation, *vdhhiz* 0x10[4] = 0 (default operation)

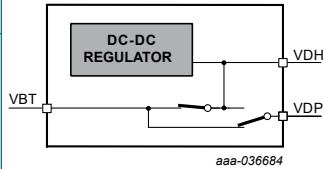
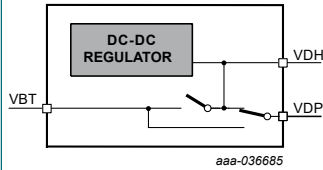
State	VDP	VDH	Diagram
Standby	Connect to VBT	Connect to VBT	 <p>Fig. 44. Standby and charge</p>
Charge	Connect to VBT	Connect to VBT	
Active	Connect to VDH	Connect to DC-DC output <i>vset</i>	 <p>Fig. 45. Active</p>

If the *vdhhiz* bit 0x10[4] is set via the serial interface, the VDH output becomes high impedance if the device is not in the Active state as indicated in [Table 21](#). The high impedance configuration is useful in cases where it is preferable to switch off a load (e.g. a sensor) connected to the VDH pin. When the high impedance *vdhhiz* mode is not required, all loads can be supplied from the VDH pin simplifying system configuration. When high impedance mode is enabled, the host microcontroller should be supplied from the VDP pin or directly from the battery.

Table 21. VDP and VDH operation, *vdhhiz* 0x10[4] = 1 (high-Z operation)

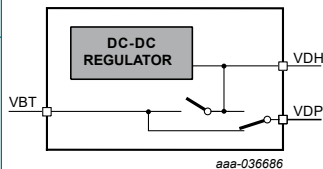
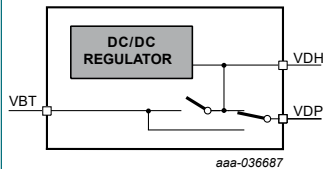
State	VDP	VDH	Diagram
Standby	Connect to VBT	Hi-Z	 <p>Fig. 46. Standby and charge</p>
Charge	Connect to VBT	Hi-Z	
Active	Connect to VDH	Connect to DC-DC output <i>vset</i>	 <p>Fig. 47. Active</p>

In more complex RF microcontroller applications with multiple input voltage pins, the VDP output can be connected to the core and I/O functions supply inputs, while the VDH output is connected to the high current RF power supply input.

The VDH pin should be connected to a bypass capacitor after accounting for derating characteristics to achieve the minimum capacitance indicated in the [Recommended components](#) table.

8.4.4.3. Setting VDH output voltage, V_{SET} (Active state)

Upon completion of a Charge state, the device transitions to the Active state at which time VDH becomes a regulated voltage output denoted as V_{SET} as configured in [vset\[3:0\]](#) in 0x09[3:0]. Unless overwritten via the serial bus, the default V_{SET} voltage is 3.0 V.

For some applications it may be beneficial to change V_{SET} during the Active state. For example, an RF microcontroller in a sensor application needs to transmit several data packets to a remote receiver. The initial data packet is transmitted at maximum power likely requiring a V_{SET} voltage of 3.6 V. After receiving an acknowledgement of a successful link with receiver, the RF microcontroller may determine a lower transmit power is sufficient and decrease the V_{SET} voltage dynamically to 3 V for duration of this transmit/receive period.

8.4.5. Adaptive power optimization

The NBM7100A/B-Q100 applies a proprietary learning algorithm to adaptively determine and optimize the amount of energy to be transferred from the battery and stored in the capacitor. This optimization engine can learn up to 63 load profiles. Each learned profile is retained in a reserved register location used by the optimization engine.

Each optimizer setting is used to store one load profile. Each stored load profile should be reasonably consistent and repetitive in energy requirements.

If [prof\[5:0\]](#) = 0h, the optimizer is disabled and the storage capacitor is charged according to the [vfix\[3:0\]](#) registers.

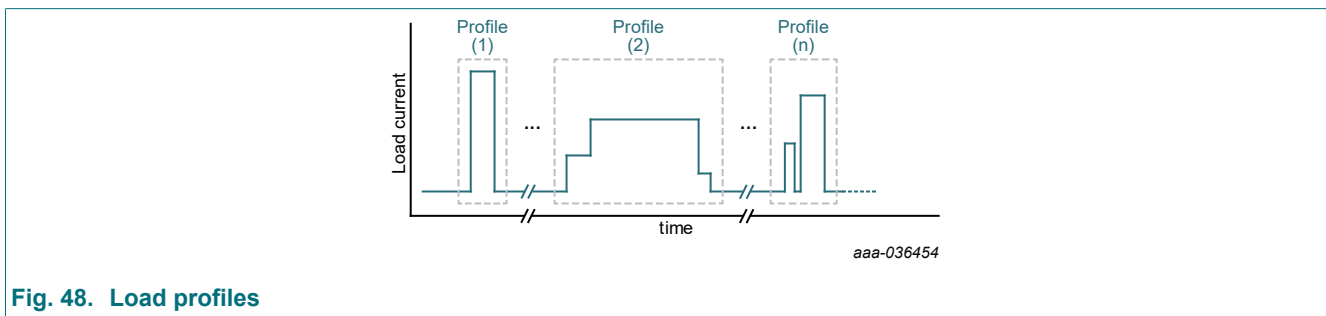

Fig. 48. Load profiles

The optimizer engine works by measuring the residual energy level in the storage capacitor after each load pulse and predicts the optimized energy level to charge the storage capacitor for the next pulse.

Optimizer profile 1 and 'extra safe' optimization margin are enabled by default after the device POR threshold is cleared. Assigning a different profile, [prof\[5:0\]](#) in 0x07, 0x08, or altering the optimization margin, [opt_margin](#) in 0x13, is performed via the [serial bus](#).

The optimizer margin voltages in [opt_marg\[1:0\]](#) correspond approximately to the first four V_{OPTX} levels and is analogous to the first four V_{FIX} levels.

8.4.5.1. Optimizer initialization and downward increment

Each optimizer profile setting learns the repetitive energy requirement of the assigned load. The number of repeated load pulses needed to reach an optimized level will vary depending upon the energy consumed. Reserved register locations maintain the target capacitor charging voltages for each profile, V_{OPTX} . V_{OPTX} is analogous to the user programmable V_{FIX} setting (optimizer profile = 0), the exception being the optimizer engine automatically increments V_{OPTX} during the initial learning phase and in response to changes in the load profile.

At the start of the optimization process, V_{OPTX} is set to $V_{CAP(MAX)}$ according to the [vcapmax](#) setting. When On-demand is initiated via register write or START pin (NBM7100A-Q100), the capacitor charges to $V_{CAP(MAX)}$. When charging is complete, the NBM7100A/B-Q100 initiates an ACTIVE cycle during which the load is applied. At the conclusion of the Active cycle the capacitor voltage is compared to the V_{OPT_MARGIN} , [opt_marg\[1:0\]](#), threshold.

- If $V_{CAP} > V_{OPT_MARGIN}$, the [voptx](#) register is decremented one setting.
- If $V_{CAP} < V_{OPT_MARGIN}$, the [voptx](#) register is incremented by at least one setting.

[Fig. 49](#) is an example of an optimizer initialization sequence. The initialization sequence occurs after device power on, or if the optimizer profile is reset, by selecting a profile number using and writing 1b to [rstpf](#) 0x08[3].

Initial conditions for initialization example:

1. Device powered and POR cleared (battery insertion).
2. $v_{capmax} 0x12[4] = 1b$.
3. V_{CAP} at zero or holding residual charge.
4. $V_{OPT_MARGIN} 0x13[1:0] = 11b$ (default)
5. $prof = 1b$ (default)

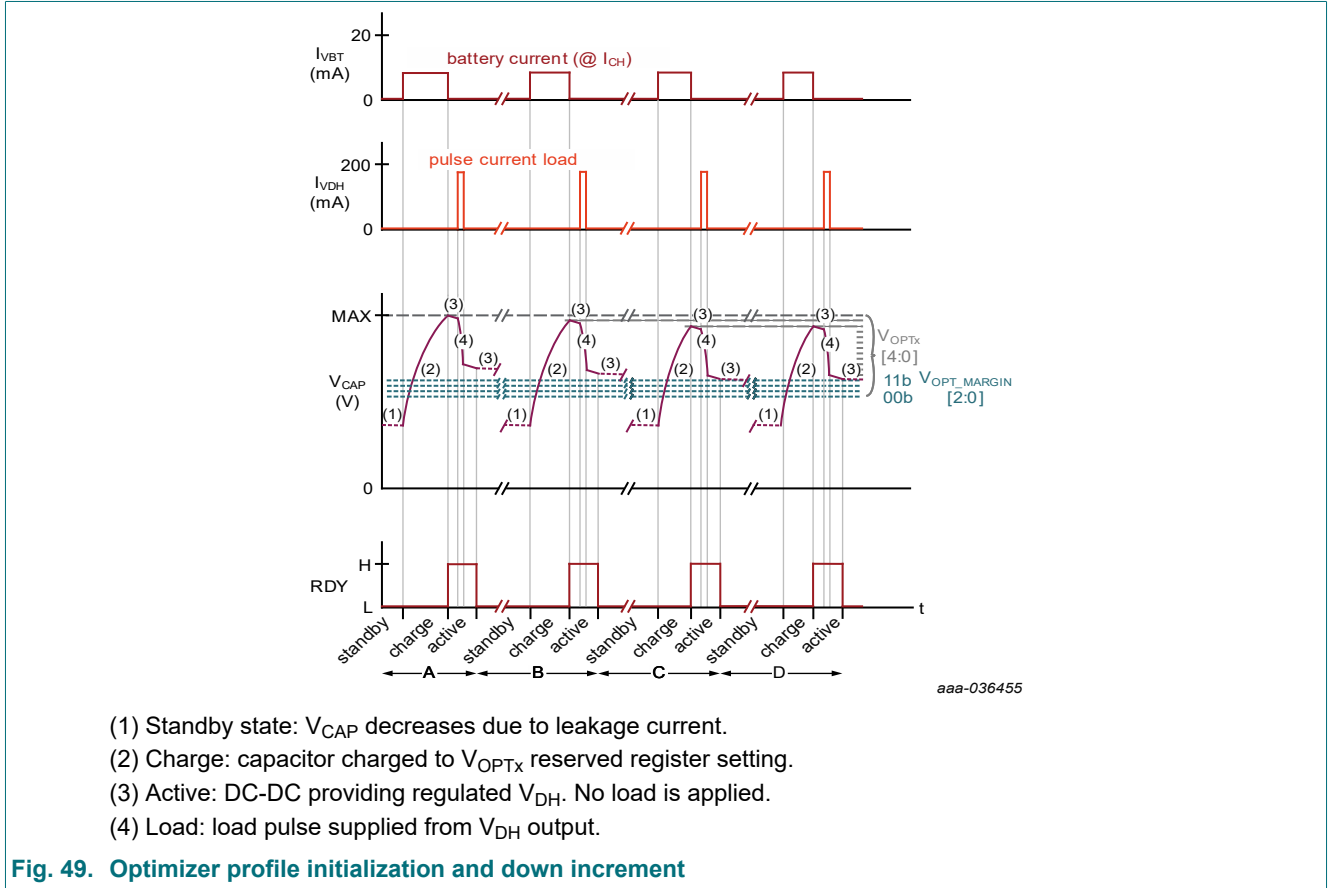

Table 22. Optimizer profile initialization and down increment

A	B	C	D
$V_{OPTX} = V_{CAP(MAX)} [15d]$	$V_{OPTX} = [14d]$	$V_{OPTX} = [13d]$	$V_{OPTX} = [13d]$
(1) Standby.			
(2) On-demand cycle initiated: Charging.			
(3) Active, no load.			
(4) Active, with load.			
(3) Active, no load.			
(1) Standby, no load.			
$V_{CAP} > V_{OPT_MARGIN}$ decrement V_{OPTX}	$V_{CAP} > V_{OPT_MARGIN}$ decrement V_{OPTX}	$V_{CAP} = V_{OPT_MARGIN}$ no change V_{OPTX}	$V_{CAP} = V_{OPT_MARGIN}$ no change V_{OPTX}

During A, B, and C as the optimization level is being approached, the charging energy from the battery is reduced becoming approximately constant in D and subsequent repetitions of D (not shown).

If after optimization, the load pulse energy is reduced by either or both reducing the peak current in the pulse, or the time the pulse persists, the state machine takes action to reduce V_{OPTX} until a new optimized level is reached.

8.4.5.2. Optimizer upward increment

If after completing an initial or downward optimization sequence as shown in [Optimizer initialization and downward increment](#), the load increases either or both in amplitude or duration, the optimizer state machine will respond with upward incrementation until a new steady-state optimization level is reached.

Initial conditions for upward increment example:

1. Device has previously optimized the selected load profile.
2. V_{CAP} at zero or holding residual charge.
3. $V_{OPT_MARGIN} 0x13[1:0] = 11b$ (default)
4. $prof = 1b$ (default)

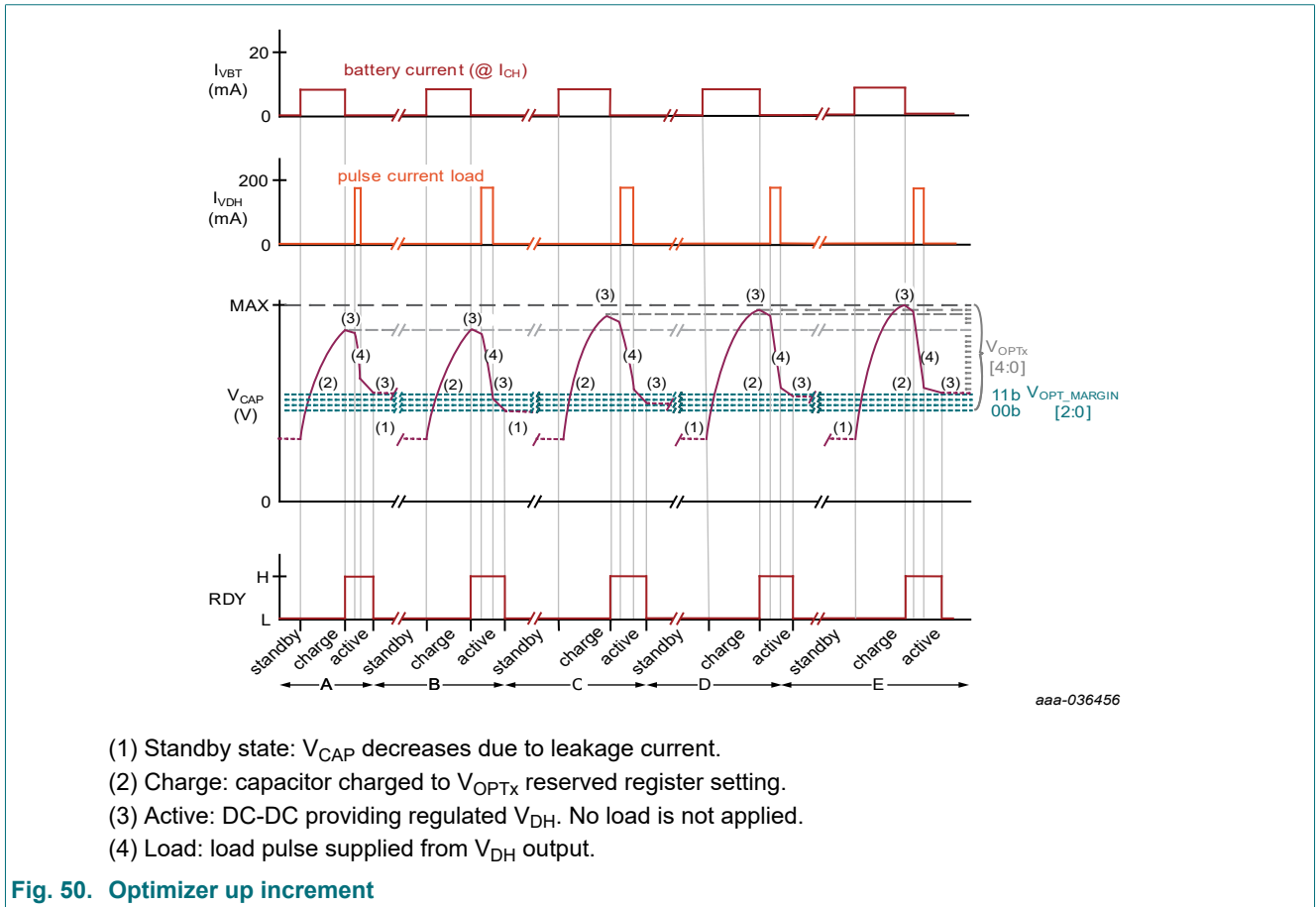

Fig. 50. Optimizer up increment

Table 23. Optimizer up increment

A	B	C	D	E
$V_{OPTx} = V_{CAP(MAX)} [11d]$	$V_{OPTx} = V_{CAP(MAX)} [11d]$; load duration increases	$V_{OPTx} = [13d]$	$V_{OPTx} = [14d]$	$V_{OPTx} = [15d]$
(1) Standby.				
(2) On-demand cycle initiated: Charging.				
(3) Active, no load.				
(4) Active, with load.				
(3) Active, no load.				
(1) Standby, no load.				
$V_{CAP} = V_{OPT_MARGIN}$ no change \bar{V}_{OPTx}	$V_{CAP} < V_{OPT_MARGIN}$ increment \bar{V}_{OPTx}	$V_{CAP} < V_{OPT_MARGIN}$ increment \bar{V}_{OPTx}	$V_{CAP} < V_{OPT_MARGIN}$ increment \bar{V}_{OPTx}	$V_{CAP} = V_{OPT_MARGIN}$ no change \bar{V}_{OPTx}

During B, the change in load is large enough to result in an ending V_{CAP} voltage well below optimizer margin voltage (11b) and results in an incrementation of two steps. At the conclusion of C and D, V_{CAP} is remains below the optimizer margin voltage, but is less severe resulting in a single step increments. The energy transferred from the battery increases in each cycle. In E, the V_{CAP} is just above the margin voltage and optimization is complete. Subsequent load profiles identical to E will not change the V_{OPTX} and are not shown.

8.4.5.3. Optimizer in steady state

[Optimizer initialization and downward increment](#) and [Optimizer upward increment](#) give an overview of the load profile optimization process. It is unlikely a load profile will be 100% consistent in magnitude and duration in an application, . Under these circumstances, the optimizer state machine may toggle between several levels. The overall result is less charge loss and more efficient use of battery capacity compared to charging to V_{FIX} to $V_{CAP(MAX)}$ regardless of load energy required.

8.4.6. Fuel Gauge

While the charging process is ongoing, the number of conversion cycles to charge C_{STORE} is counted. Each conversion cycle represents a fixed amount of charge taken up from the battery irrespective of the charge level of C_{STORE} based on one switching cycle of the [DC-DC boost](#) regulator. The accumulated result of counting repetitive conversion cycles represents a good indication of the battery capacity used. The counting result is stored in the 32 bit word of the fuel gauge registers [chenergy](#).

The accumulated results in these registers can be read from the serial bus at any time in the Standby state. The register is reset if:

- in Continuous mode the Active state transitions to the Charge state: 0x08[2:0] transitions from 6h to 2h.
- in On-demand mode the Active state transitions to the Charge state: 0x08[2:0] transitions from 5h to 1h.

For an estimate of the battery lifetime the results must be accumulated by the host microcontroller. Each count (Q_N) of the fuel gauge register represents an electrical charge:

Table 24. Fuel Gauge

Note: The Fuel Gauge does not take the bias currents of the Battery booster circuit into account.

$I_{CH}[2:0] = 0-3$ (normal charge)	$I_{CH}[2:0] = 4$ (emergency charge)
$Q_N = \frac{1}{2} \cdot I_{L(peak)} \cdot t_{prim}$	$Q_N = I_{L(peak)} \cdot t_{prim}$
$I_{L(peak)} = T_{prim} \cdot V_{VBT} \cdot \frac{1}{L}$ $t_{prim} = 400 \text{ ns (fixed)}$	$I_{L(peak)} = T_p \cdot V_{VBT} \cdot \frac{1}{L}$ $t_{prim} = T_p$
Filling in the typical values for V_{VBT}, T_p and L: $V_{VBT} = 3 \text{ V}$ $L = 15 \mu\text{H}$ $T_p = 1 \mu\text{s}$ results in:	
$Q_N = 16 \cdot 10^{-9} \text{ [C]}$ or in usual battery capacity $Q_N = 4.4 \cdot 10^{-12} \text{ [Ah]}$	$Q_N = 200 \cdot 10^{-9} \text{ [C]}$ or in usual battery capacity $Q_N = 55 \cdot 10^{-12} \text{ [Ah]}$
Q_N is the equivalent charge associated with 1 count in the fuel-gauge counter, expressed in Coulomb or in Ampere/Hours. V_{VBT} is the assumed battery voltage. $I_{L(peak)}$ is the peak inductor current. t_{prim} is the duration of the primary DC-DC conversion phase. T_p is the conversion period time (1 μs). As an example: the capacity of a typical CR2032 battery (220 mAh) is represented by a total of $50 \cdot 10^9$ counts.	

9. Register map

NBM7100A/B-Q100

Table 25. Condensed register map

Register No	HEX	Bit								Register name	R/W
		7	6	5	4	3	2	1	0		
0	0x00	<i>lowbat</i>	<i>ew</i>	<i>alm</i>	-	-	-	-	<i>rdy</i>	status	R
1	0x01	<i>chengy[31]</i>	<i>chengy[30]</i>	<i>chengy[29]</i>	<i>chengy[28]</i>	<i>chengy[27]</i>	<i>chengy[26]</i>	<i>chengy[25]</i>	<i>chengy[24]</i>	chenergy	R
2	0x02	<i>chengy[23]</i>	<i>chengy[22]</i>	<i>chengy[21]</i>	<i>chengy[20]</i>	<i>chengy[19]</i>	<i>chengy[18]</i>	<i>chengy[17]</i>	<i>chengy[16]</i>	chenergy	R
3	0x03	<i>chengy[15]</i>	<i>chengy[14]</i>	<i>chengy[13]</i>	<i>chengy[12]</i>	<i>chengy[11]</i>	<i>chengy[10]</i>	<i>chengy[9]</i>	<i>chengy[8]</i>	chenergy	R
4	0x04	<i>chengy[7]</i>	<i>chengy[6]</i>	<i>chengy[5]</i>	<i>chengy[4]</i>	<i>chengy[3]</i>	<i>chengy[2]</i>	<i>chengy[1]</i>	<i>chengy[0]</i>	chenergy	R
5	0x05	-	-	-	<i>vcap[4]</i>	<i>vcap[3]</i>	<i>vcap[2]</i>	<i>vcap[1]</i>	<i>vcap[0]</i>	vcap	R
6	0x06	-	-	-	<i>vchend[4]</i>	<i>vchend[3]</i>	<i>vchend[2]</i>	<i>vchend[1]</i>	<i>vchend[0]</i>	vchend	R
7	0x07	-	-	-	-	-	-	<i>prof[5]</i>	<i>prof[4]</i>	profile_msb	R/W
8	0x08	<i>prof[3]</i>	<i>prof[2]</i>	<i>prof[1]</i>	<i>prof[0]</i>	<i>rstpf</i>	<i>act</i>	<i>ecm</i>	<i>eod</i>	command	R/W
9	0x09	<i>vfix[3]</i>	<i>vfix[2]</i>	<i>vfix[1]</i>	<i>vfix[0]</i>	<i>vset[3]</i>	<i>vset[2]</i>	<i>vset[1]</i>	<i>vset[0]</i>	set1	R/W
10	0x0A	<i>ich[2]</i>	<i>ich[1]</i>	<i>ich[0]</i>	<i>vdhhiz</i>		<i>vmin[2]</i>	<i>vmin[1]</i>	<i>vmin[0]</i>	set2	R/W
11	0x0B	<i>automode</i>	-	-	<i>eew</i>	<i>vew[3]</i>	<i>vew[2]</i>	<i>vew[1]</i>	<i>vew[0]</i>	set3	R/W
12	0x0C	-	-	-	<i>vcapmax</i>	-	-	-	-	set4	R/W
13	0x0D	-	-	-	-	-	-	<i>opt_marg[1]</i>	<i>opt_marg[0]</i>	set5	R/W

At startup all bits are cleared except for:

<i>prof[5:0]</i>	00001	Profile_index = 1
<i>vset[3:0]</i>	1001	V _{set} = 3.0 V
<i>ich[2:0]</i>	100	I _{ch} = 8 mA
<i>automode</i>	*	Set for NBM7100A (I ² C) only

10. Programming Tables

10.1. Status information

Table 26. *status* Register - Status information

Register 0 0x00 (read)	Explanation	Reset condition
bit [7], Low battery input voltage (<i>vmin</i>)	Occurs in Charge state. <i>vmin</i> = 1: Indicates that a low battery condition (V_{MIN} threshold) occurred during charge state. $V_{VBT} < V_{MIN}$	Once set, this alarm is not cleared without power cycling the device.
bit [6], Capacitor input voltage Early warning (<i>ew</i>)	Occurs in Active state. <i>ew</i> = 1: Indicates that the storage capacitor voltage has fallen below the V_{EW} threshold during active state. $V_{CAP} < V_{EW}$ RDY pin pulses low for t_{EW}	Cleared at the start of the next charging cycle.
bit [5], VDH output Alarm (<i>alarm</i>)	Occurs in Active state. <i>alarm</i> = 1: Indicates that a VDH alarm condition occurred during active state (too high load current or too low voltage at V_{CAP}). $V_{DH} < V_{SET}$ RDY is driven low.	Cleared at the start of the next charging cycle.
bit [0], Ready (<i>rdy</i>)	<i>rdy</i> = 1: Output status indication. See Section 8.4.1.2 .	

10.2. Mode controls

Table 27. *command* and *set3* Registers - Mode control

Register 8 0x08 (write)	Code (bin)	Function	Remark
bit [0] <i>eod</i> (enable On-demand)	0	off	-
	1	on	-
bit [1] <i>ecm</i> (enable Continuous mode)	0	off	-
	1	on	-
bit [2] <i>act</i> (force Active state)	0	off	-
	1	on	force active
bit [3] <i>rstpf</i> (reset optimizer)	0	-	-
	1	reset	reset optimizer result of active profile prof[5:0]
Register 11 (write)			
bit [7] <i>automode</i>	0	off	default for NBM7100B-Q100 version [1]
	1	on	default for NBM7100A-Q100 version

[1] NBM7100B-Q100 cannot be written to 1.

10.3. VDH Output voltage control (V_{SET})

Table 28. *set1* Register - Output voltage control *vset*[3:0]: (V_{SET})

Register 9 0x09 (write)	Code (bin)	V_{SET}	Unit
bits [3:0]	0000	1.8	V
	0001	2.0	V
	0010	2.2	V
	0011	2.4	V
	0100	2.5	V
	0101	2.6	V
	0110	2.7	V
	0111	2.8	V
	1000	2.9	V
	default 1001	3.0	V
	1010	3.1	V
	1011	3.2	V
	1100	3.3	V
	1101	3.4	V
	1110	3.5	V
	1111	3.6	V

10.4. Capacitor end-of-charge voltage (V_{FIX})

Table 29. *set1* Register - End-of-charge voltage *vfix*[3:0]: (V_{FIX})

Register 9 [1] 0x09 (write)	Code (bin)	V_{FIX}	Unit
bits [7:4]	0001	3.4	V
	0010	4.4	V
	0011	5.2	V
	0100	5.9	V
	0101	6.5	V
	0110	7.1	V
	0111	7.7	V
	1000	8.2	V
	1001	8.7	V
	1010	9.1	V
	1011	9.5	V
	1100	9.9	V
	1101	10.3	V
	1110	10.7	V
	1111	11.0	V

V_{FIX} applies if *prof*[5:0] = 0h (profile = 0)

[1] The default state is 0000. This register should be set to a defined value if *prof* = 0h.

10.5. Capacitor maximum storage voltage ($V_{CAP(MAX)}$)

Table 30. *set4* Register - Maximum storage voltage *vcapmax*: ($V_{CAP(MAX)}$)

Register 12 0x0C (write)	Code (bin)	$V_{CAP(MAX)}$	Unit
bit [4]	default 0	9.9	V
	1	11.0	V

10.6. VBT pin minimum input voltage comparator threshold (V_{MIN})

Table 31. *set2* Register - Input threshold voltage *vmin[2:0]*: (V_{MIN})

Register 10 0x0A (write)	Code (bin)	V_{MIN}	Unit
bits [2:0]	default 000	2.4	V
	001	2.6	V
	010	2.8	V
	011	3.0	V
	100	3.2	V

10.7. Capacitor charge current (I_{CH})

Table 32. *set2* Register - Charge current *ich[2:0]*: (I_{CH})

Register 10 0x0A (write)	Code (bin)	I_{CH}	Unit
bits [7:5]	000	2.0	mA
	001	4.0	mA
	default 010	8.0	mA
	011	16.0	mA
	emergency charge, $I_{CH} = \max$	100	50.0
do not use	101	undefined	
	110		
	111		

10.8. CAP pin input voltage comparator Early Warning voltage (V_{EW})

Table 33. *set3* Register - Early Warning voltage *veew*[3:0] and *eew* (V_{EW})

Register 11 0x0B (write)	Code (bin)	V_{EW}	Unit
bits [3:0] default	0000	2.4	V
	0001	2.6	V
	0010	2.8	V
	0011	3.0	V
	0100	3.2	V
	0101	3.4	V
	0110	3.6	V
	0111	4.0	V
	1000	4.4	V
	1001	4.8	V
Bit [4] EEW (enable early warning)	0	off	
	1	on	

10.9. VDH switch configuration

Table 34. *set2* Register - VDH switch configuration *vdhhiz*

Register 10 0x0A (write)	Code (bin)	Parameter
bit [4], VDH high-impedance mode in Standby and Active states	0	$V_{VDH} = V_{VBT}$
	1	high impedance

10.10. Optimizer profile selection

Table 35. *profile_msb* and *command* Registers - Optimizer profiles: *prof*[5:0]

Register 7 & 8 0x07 & 0x08 (write)	Code (bin)	Profile number	Remark
bits R7[1:0] R8[7:4] If profile = 0 is selected, no optimization occurs, V_{FIX} is applied default	00 0000	-	Fixed mode
	00 0001	1	-
	00 0010	2	-
	-
	11 1111	63	-

10.11. Optimization margin voltage

Table 36. *set5* Register - Optimization margin: *opt_marg[1:0]*

Register 13 0x0D (write)	Code (bin)		Target V_{STORE}	Unit
bits [1:0] default	00	minimum	3.41	V
	01	nominal	4.39	V
	10	safe	5.21	V
	11	extra safe	5.91	V

10.12. Fuel gauge

Table 37. *chengy* Registers: Fuel gauge

Register 1 - 4 0x01 - 0x04 (read)	Explanation	Reset condition
Register [1:4]	Register 1 (MSB): 4 (LSB) represents the 32 bit result of the energy measurement. See Section 8.4.6	Reset at the start of the next charge cycle.

10.13. Storage capacitor voltage status (V_{CAP})

Table 38. vcap and vchend Registers - Storage capacitor status vcap[4:0] (V_{CAP}) and end of charge vchend[4:0] comparator thresholds associated for vfix[3:0]

Note: Register 5 (V_{CAP}) is only maintained during charge and active state. In case V_{CAP} voltage drops in STB state due to leakage this is not represented. Register 6 (V_{CHEND}) is set at the start of the CHARGE state.

Register 5 Actual V_{CAP} 0x05 (read)	Code (bin)	V_{CAP} ; V_{CHEND}
Register 6 Target Charge voltage (V_{CHEND}) 0x06 (read)		
bits [4:0]	00000	1.40 V
	00001	1.51 V
	00010	1.80 V
	00011	2.19 V
	00100	2.40 V
	00101	2.60 V
	00110	2.79 V
	00111	3.01 V
	01000	3.20 V
	01001	3.41 V
	01010	3.61 V
	01011	3.99 V
	01100	4.39 V
	01101	4.80 V
	01110	5.21 V
	01111	5.59 V
	10000	5.91 V
	10001	6.02 V
	10010	6.40 V
	10011	6.55 V
	10100	6.80 V
	10101	7.14 V
	10110	7.23 V
	10111	7.68 V
	11000	8.19 V
	11001	8.65 V
	11010	9.10 V
	11011	9.53 V
	11100	9.91 V
	11101	10.33 V
	11110	10.69 V
	11111	11.07 V

11. Application and implementation

11.1. Application information

Note: Application implementation information in the following sections is not part of the Nexperia component specification. Nexperia's device users are responsible for determining suitability of components for their purposes, as well as validating and testing their design implementation to confirm system functionality.

The NBM7100A/B-Q100 is an integrated power management device ideally suited at transferring energy from high impedance batteries at a programmable rate to an intermediate storage capacitor where it is subsequently supplied to pulse current loads. The two-stage transfer process minimizes stress on the battery extending the lifetime.

11.2. Typical application

A typical implementation consists of a radio frequency microcontroller, and a NBM7100A/B-Q100 pulse load power management device.

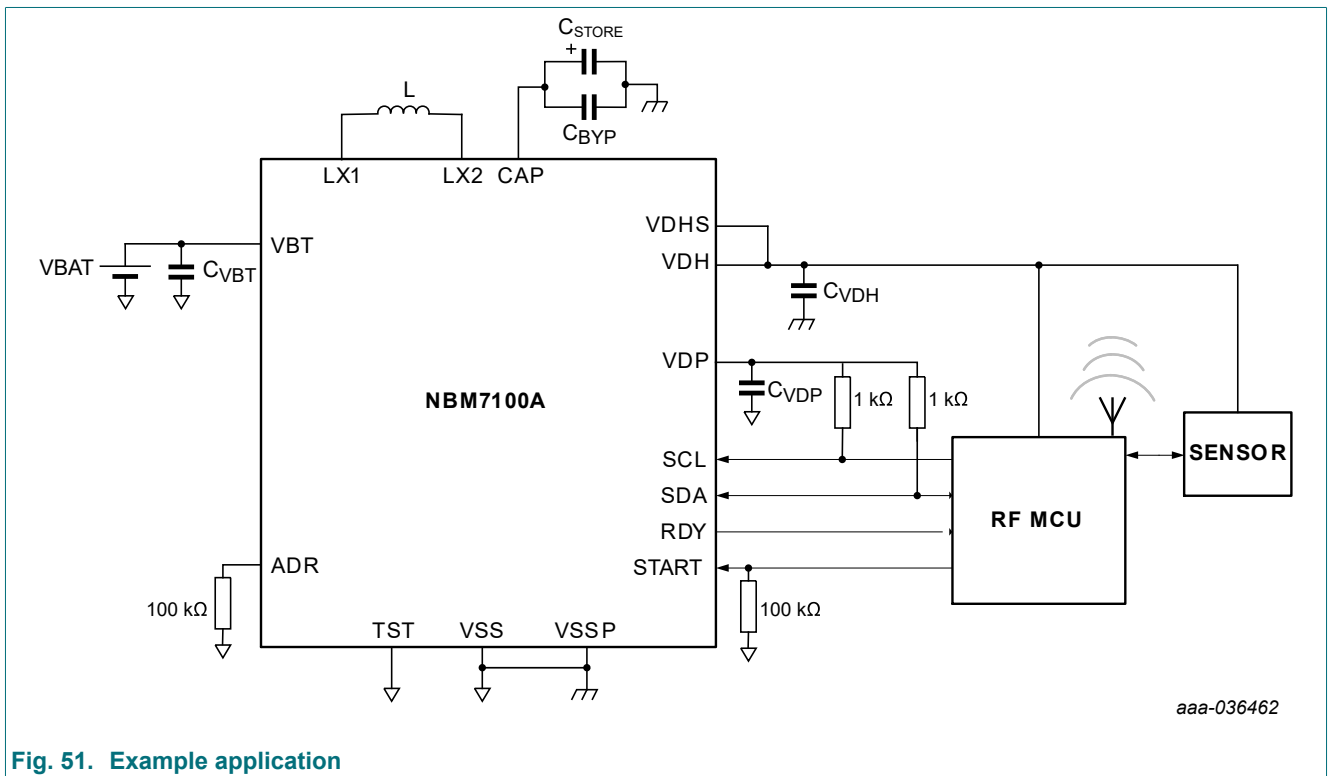

Fig. 51. Example application

Table 39. Design requirements

Parameter	Values
Battery type	CR2032
Input (battery) voltage	$2.4 \leq V_{VBT} \leq 3.0 \text{ V}$
Regulated output voltage at VDH pin (Active state)	$1.8\text{V} \leq V_{SET} \leq 3.6 \text{ V}$
Load profile current	up to 100 mA
Load profile duration	up to 200 ms
$V_{CAP(MAX)}$	11 V
Use optimizer	No
C_{store} capacitor type	polymer

11.3. DC-DC switching frequency and inductor selection

The internal DC-DC converter operates at a fixed frequency of approximately 1 MHz. It is not user adjustable. It is designed to operate with 15 μH ($\pm 20\%$, standard tolerance) and a saturation current rating of 1 A (minimum). Using an inductor with significantly different ratings may cause control loop instability.

Table 40. Recommended inductors

Type number	L (μH)	DCR (m Ω)	saturation current	Size (l \times w \times h) mm	vendor
XGL4040-153ME	15	80	1.2	4 \times 4 \times 4.1	Coilcraft
SRN4018-150M	15	264	1.1	4 \times 4 \times 1.8	Bournes
74404042150	15	210	1.4	4 \times 3.3 \times 1.8	Würth

11.4. Output voltage setting, V_{SET}

The VDH output pin is regulated at the value of V_{SET} during the active state. The default value is 3.0 V and may be adjusted in register 0x09[3:0]. Refer to [Setting VDH output voltage, \$V_{SET}\$ \(Active state\)](#).

11.5. Input capacitor, C_{VBT} and charge current, I_{CH} setting

During the charge state the DC-DC converter operates in boost mode. A constant current is drawn from the VBT pin according to the *ich* setting in register 0x10[7:5]. The capacitor ripple current is negligible and a 6.3V ceramic, 1 μF (minimum) located close to the VBT pin is suggested.

The default charging current, I_{CH} , is 8 mA. It can be adjusted in the **set2** register 0x10[7:5] via the serial interface.

11.6. Output capacitors, C_{VDP} and C_{VDH}

The VDP pin connects to VBT via an internal power switch in all states, except Active where it is connected to the regulated DC-DC output, VDH. The VDP output cannot be disabled via serial interface and as it is intended to supply always 'on' system loads of up to 10 mA. A 6.3V, 1 μF ceramic located close to the VDP pin is suggested.

The VDH pin is the output of the DC-DC converter during an active cycle. To ensure stability and low output ripple under all DC-DC operating conditions, a *derated* capacitance of 22 μF is recommended. Check manufacturer derating curves and select a suitable capacitor voltage rating to achieve the derated minimum. In this example, a 16 V, 22 μF , X7R with $< |-10| \%$ DC bias is chosen. The VDH output may be disabled when not in the Active state by setting *vdhhiz* = 1.

11.7. Storage capacitor, C_{STORE}

Sizing the energy storage capacitor depends on the worst case load profile required in the application. A suggested approach is to calculate the energy in μJ required to support the load pulse. The area under the curve gives a first order approximation of the minimum energy needed for the load, not considering conversion losses or leakage currents. See figure [Fig. 37](#).

The type (ceramic, electrolytic, polymer, film, supercapacitor) of a single storage capacitor, or parallel combination of multiple capacitors used in an application depends on: PCB area available, volume available within the end-product enclosure, cost, etc. The critical factors in the final selection are: 1) a voltage rating higher than $V_{\text{CAP(MAX)}}$, and 2) an equivalent series resistance (ESR) less than $1\ \Omega$.

- Area under pulse load portion of the curve (charge in microcoulombs). $\text{CHG} = t_{\text{ON}} \times I_{\text{PK}}$ in μC . Where
 - t_{ON} = duration of the load pulse in ms.
 - I_{PK} = load pulse current in mA.
- Calculate the energy, E, in microjoules, μJ by multiplying above by V_{SET} and add margin for energy conversion and leakage losses: 15 - 20%. Assume 20% as a starting point for a factor of 1.2.
 $E = \text{charge} \times \text{voltage} = \text{CHG} \times V_{\text{SET}} \times 1.2$ in μJ .
- Calculate $\Delta V_{\text{CSTORE}} = (V_{\text{CSTORE(high)}} - V_{\text{CSTORE(low)}})$, where
 - $V_{\text{CSTORE(low)}} = V_{\text{SET}} + 0.3\ \text{V}$. Add 0.3 V, or greater, to the regulated V_{SET} voltage to account for DC-DC dropout when the capacitor voltage depletes close to the regulation voltage.
 - $V_{\text{CSTORE(high)}} = V_{\text{FIX}}$ in 0x09[7:4], and $V_{\text{FIX}} \leq V_{\text{CAP(MAX)}}$. See [Section 8.4.2.3](#).
- Calculate nominal C_{STORE} capacitance in μF : $C_{\text{STORE}} = (2 \times E) / (V_{\text{CSTORE(high)}}^2 - V_{\text{CSTORE(low)}}^2)$ μF
- Apply appropriate voltage and temperature ratings based on storage capacitor type: Aluminum electrolytic, Aluminium polymer, ceramic, supercapacitor, etc.
- Select standard value larger than calculated in step 4 with an ESR < 1 ohm and voltage rating larger than $V_{\text{CAP(MAX)}}$. Additional ceramic capacitors, C_{BYP} may be used to decrease the effective ESR.
- Test system under load profile used in step 1. Additional margin may be required to account for early warning response time and serial port communication from microcontroller. Iterate as necessary.

In this design example a load of 100 mA for 10 ms is chosen. Calculation steps show below:

- $\text{CHG} = 100\ \text{mA} \times 10\ \text{ms} = 1000\ \mu\text{C}$
- $E = 1000\ \mu\text{C} \times 3.0\ \text{V} \times 1.2 = 4320\ \mu\text{J}$ (20% margin assumed in 1.2 multiplier)
- $V_{\text{CSTORE(low)}} = V_{\text{SET}} + \text{margin V} = 3.0\ \text{V} + 0.5\ \text{V}$ (extra conservative) = 3.5 V
 - Set $V_{\text{CSTORE(high)}} = V_{\text{fix}} = V_{\text{CAP(MAX)}} = 11\ \text{V}$
- $C_{\text{CSTORE(nom)}} = 2 \times 4320\ \mu\text{J} / (11\ \text{V}^2 - 3.5\ \text{V}^2) = 79.4\ \mu\text{F}$
- Assume C_{store} capacitor tolerance of $\pm 20\%$ (typical for an electrolytic). $C_{\text{CSTORE(actual)}} = 79.4\ \mu\text{F} \times 1.2 = 95.3\ \mu\text{F}$.
- Select a 16 V rated capacitor with closest standard value of 100 μF .
- Select 16 V (or higher) rated, low ESR parallel ceramic, C_{BYP} = 10 μF

11.8. External resistors

NBM7100A-Q100: I²C SCL and SDA pull-up resistors: consult with [Table 12](#), the host controller data sheet and industry I²C specifications to size the SCL and SDA pin pullup resistors. For this application example, PCB trace capacitance, C_b, is assumed to be < 400 pF, allowing Fast-mode Plus (1 Mbit/s) data transfer. 1 k Ω resistances as indicated in [example application diagram](#) are used as a compromise between signal integrity and power consumption.

NBM7100A-Q100 ADR pin pullup or pull-down resistor: Refer to [Table 18](#) for available slave addresses. For a '1' connect the ADR pin to the VDP pin via a pullup resistor. For '0' connect the ADR pin to the VSS pin with a pull-down resistor. A standard resistor value between 1k Ω and 100 k Ω is suggested, but can be omitted so long as a '1' or '0' electrical connection is made via PCB trace. A pull-down of 100 k Ω is chosen for this example.

NBM7100A-Q100: START pin resistor: To prevent spurious initiation of Auto mode during power-up or due to a high-Z condition from an external host, a pull-down resistor is recommended. The value of resistor should be low enough to ensure the START pin is held low when not being actively driven, and high enough to prevent loading the external host controller output when driven high. A pull-down of 100 k Ω is chosen for this example.

11.9. Suggestions for controlling NBM7100A/B-Q100 via serial interface

At initialization:

1. Do not initiate any read or write sequences until at least 20 ms after the NBM7100A/B-Q100 has completed power-on reset (battery insertion).
2. As required by the application after POR, update default registers as needed:
 - a. Write 0x10: vmin, vdhhiz, ich.
 - b. Write 0x11: vew, eew. Monitoring the early warning indication is suggested.
 - c. Write 0x12: vcapmax.
 - d. Write 0x13: opt_marg.

Initiating On-demand

1. Write 0x08 and 0x09: set prof number or use V_{fix} .
2. Write 0x09: vset and vfix. vfix required if optimizer not used.
3. Write 0x08: set eod bit.
4. Monitor RDY pin with GPIO, or poll 0x00[0] for RDY = 1. When RDY = 1, $V_{DH} = V_{SET}$.
5. Apply pulsed load and monitor RDY pin for ew, or continuously poll 0x00 for alarm, ew, and lowbat indications
 - a. If ew via RDY or 0x00, disable load, write 0x08[2:0] as 000b to enter standby. Capacitor is near depletion.
 - b. If alarm, disable load, write 0x08[2:0] as 000b to enter standby. The DC-DC is no longer able to regulate V_{DH} due to overload or capacitor is near depletion.
 - c. If lowbat, battery is becoming depleted and needs replacement. Operation may continue.
6. Load pulse complete, write 0x08[2:0] as 000b to enter standby.
7. Repeat sequence for subsequent On-demand cycles.

Initiating Continuous

1. Write 0x08 and 0x09: set prof number or use V_{FIX} .
2. Write 0x09: vset and vfix. vfix required if optimizer not used.
3. Write 0x08: set ecm bit.
4. Monitor RDY pin with GPIO, or poll 0x00[0] for RDY = 1. When RDY = 1, Write 0x08[2] to enter active mode, $V_{DH} = V_{SET}$.
5. Apply pulsed load and monitor RDY pin for ew, or continuously poll 0x00 for alarm, ew, and lowbat indications
 - a. If ew via RDY or 0x00, disable load, write 0x08[2:0] as 000b to enter standby. Capacitor is near depletion.
 - b. If alarm, disable load, write 0x08[2:0] as 000b to enter standby. The DC-DC is no longer able to regulate V_{DH} due to overload or capacitor is near depletion.
 - c. If lowbat, battery is becoming depleted and needs replacement. Operation may continue.
6. Load pulse complete, write 0x08[2:0] as 000b to enter standby; or 0x08[2:0] as 010b to return to Continuous mode.
7. Repeat sequence for subsequent Continuous mode cycles.

11.10. Application curves

$V_{VBT} = 3.0\text{ V}$; $C_{VBT} = 1\ \mu\text{F}$; $C_{VDP} = 1\ \mu\text{F}$; $C_{VDH} = 22\ \mu\text{F}$; $L = 15\ \mu\text{H}$; unless otherwise specified.

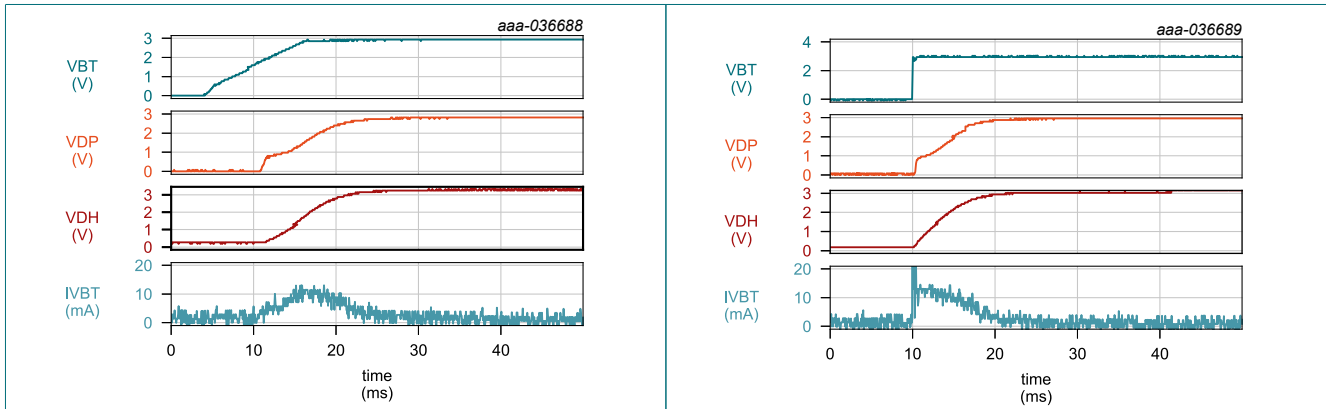

V_{VBT} ramps from 0 to 3 V in 12.5 ms

Fig. 52. POR (VBT slow ramp)

V_{VBT} ramps from 0 to 3 V in 5 μs

Fig. 53. POR (VBT fast ramp)

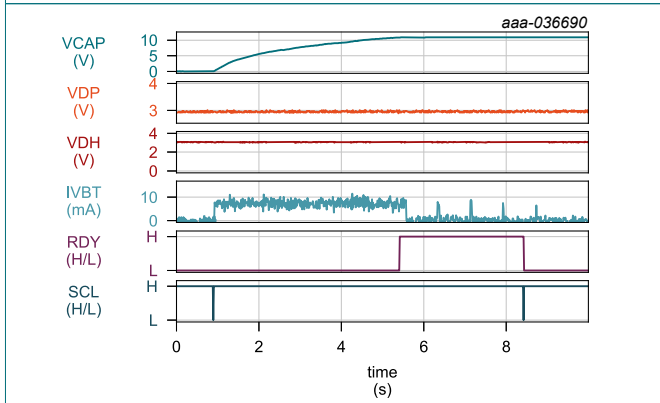

$V_{VBT} = V_{DP} = V_{DH} = 3\text{ V}$
 $V_{FIX} = 11\text{ V}$; $I_{CH} = 8\text{ mA}$
 Standby \rightarrow Continuous \rightarrow Standby

Fig. 54. Continuous mode

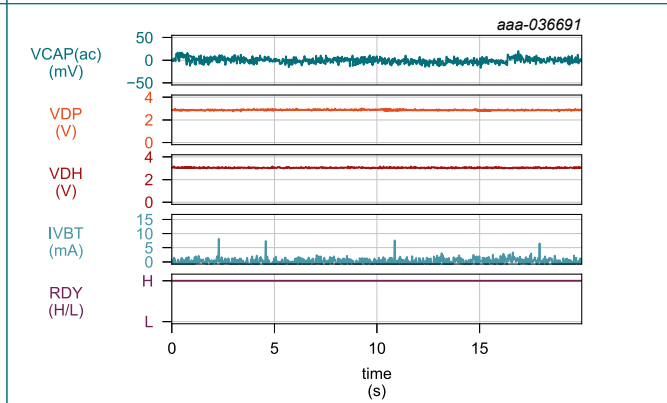

$V_{VBT} = V_{DP} = V_{DH} = 3\text{ V}$
 $V_{FIX} = 11\text{ V}$; $I_{CH} = 8\text{ mA}$
 Continuous mode: monitor, refresh, monitor

Fig. 55. Continuous mode with V_{CAP} refresh pulses

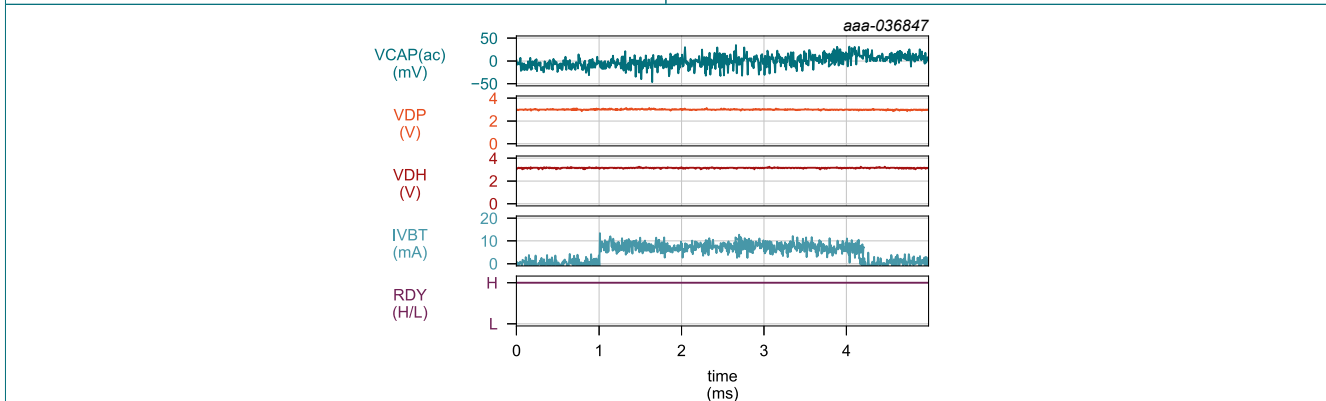

$V_{VBT} = V_{DP} = V_{DH} = 3\text{ V}$
 $V_{FIX} = 11\text{ V}$; $I_{CH} = 8\text{ mA}$
 Continuous mode: monitor, refresh, monitor

Fig. 56. Continuous mode with single V_{CAP} refresh pulse, V_{CAP} : AC coupled

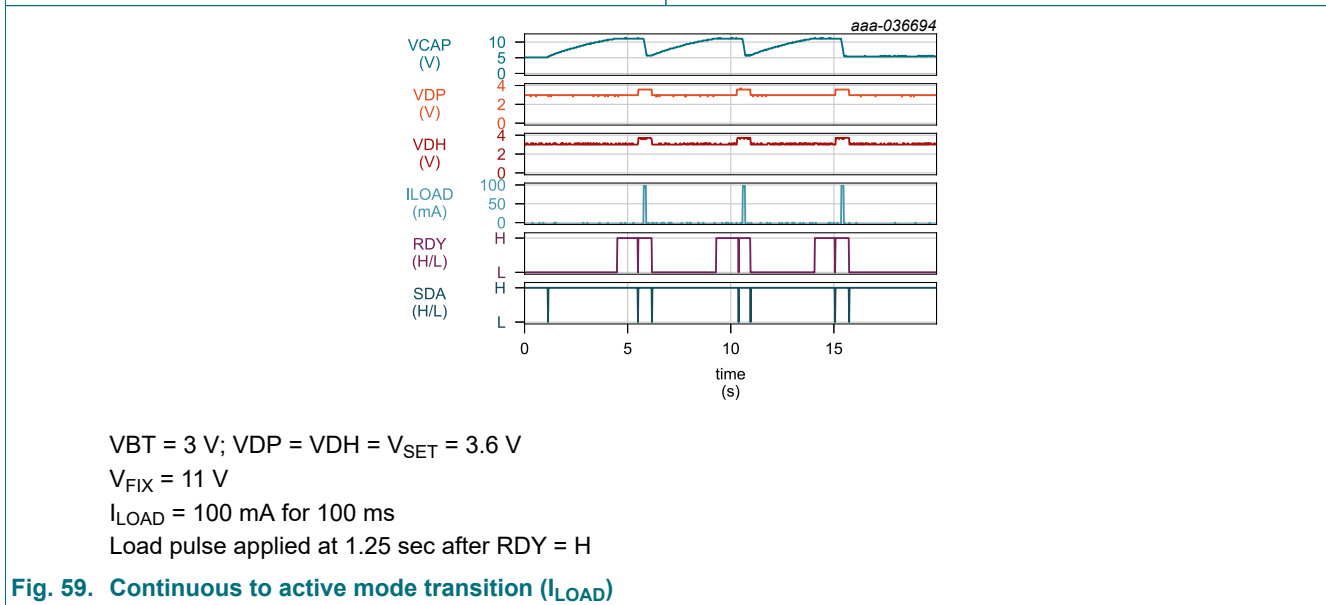
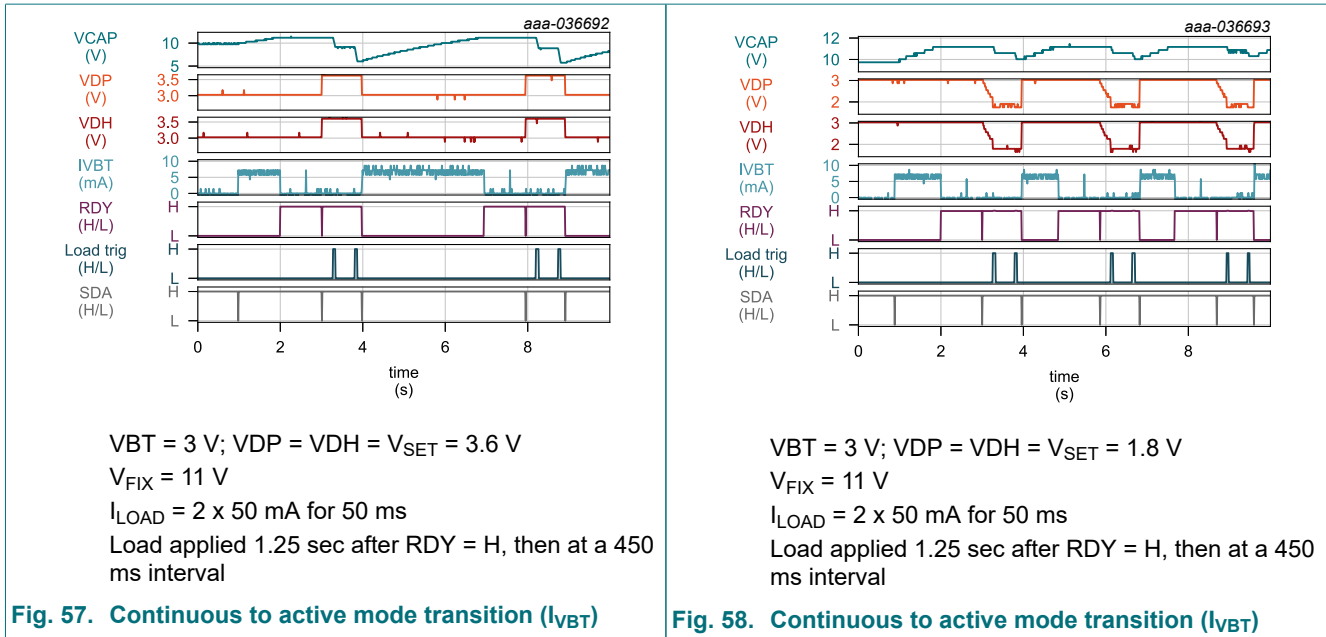

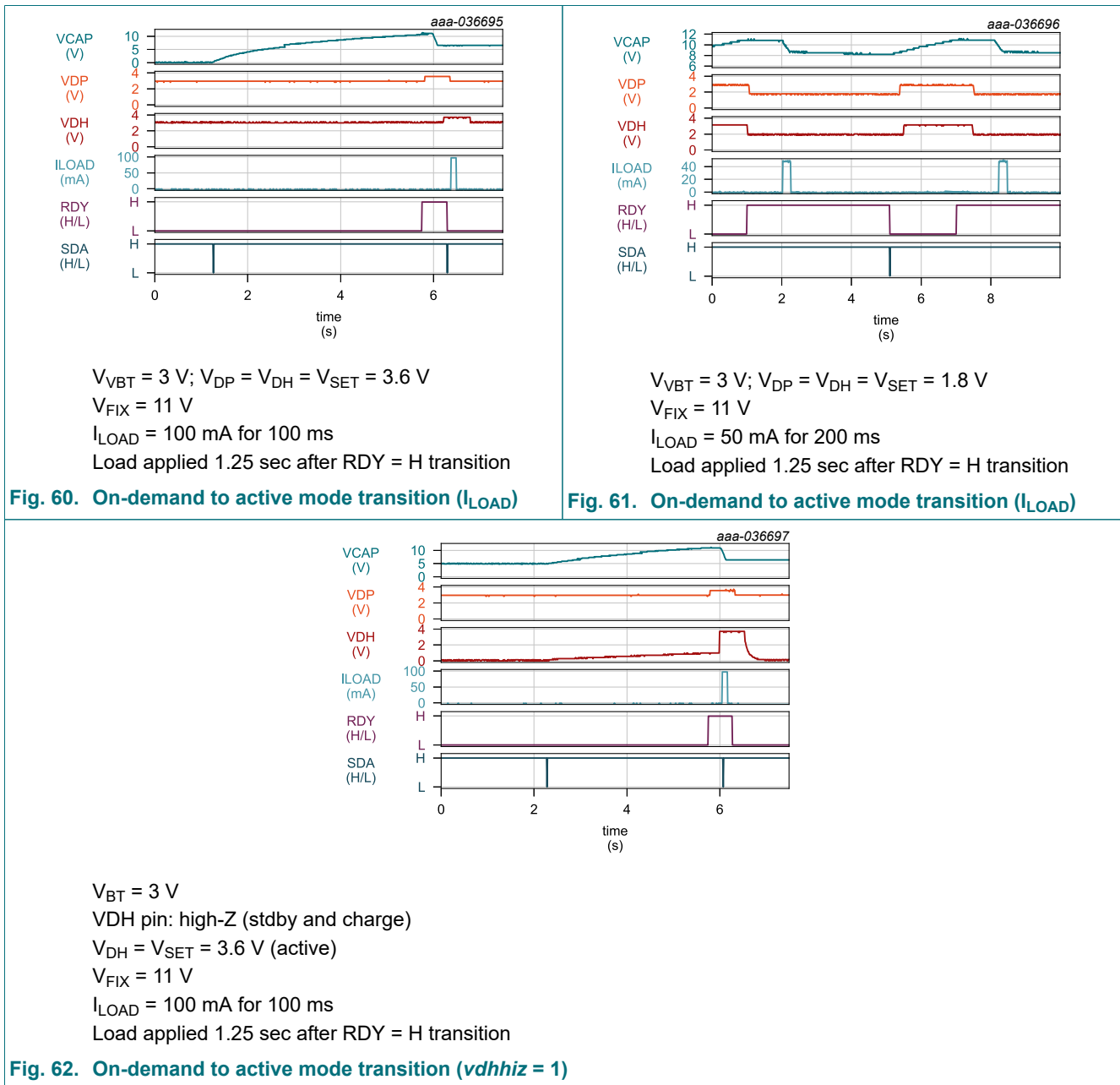

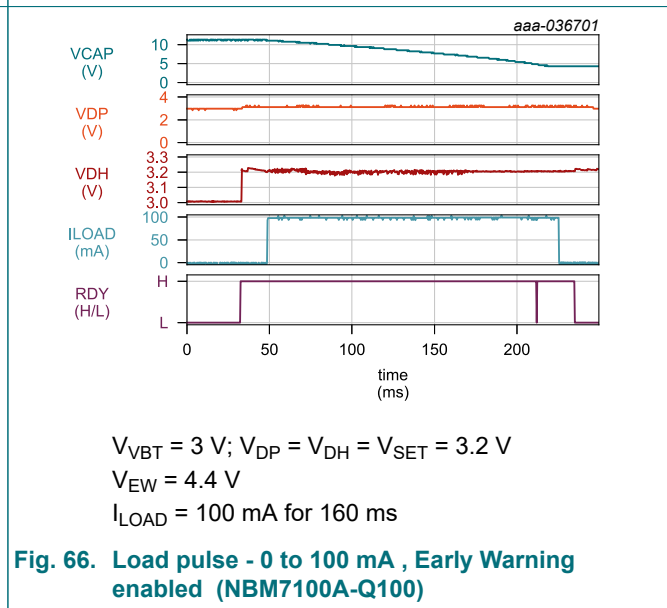
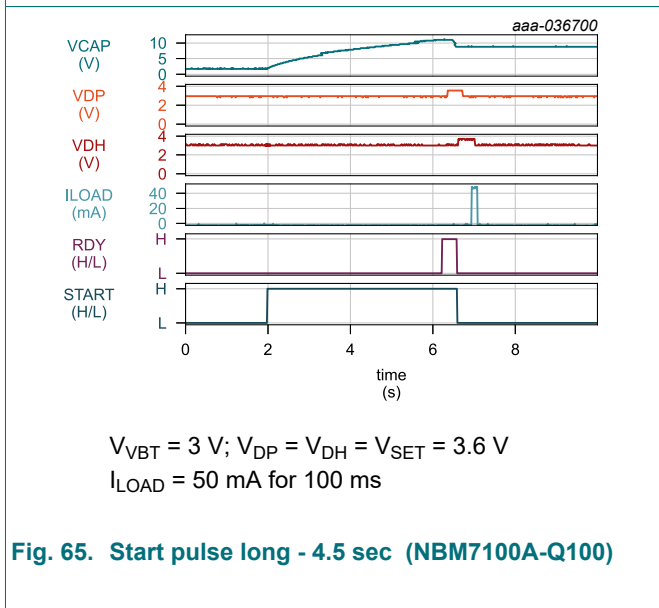
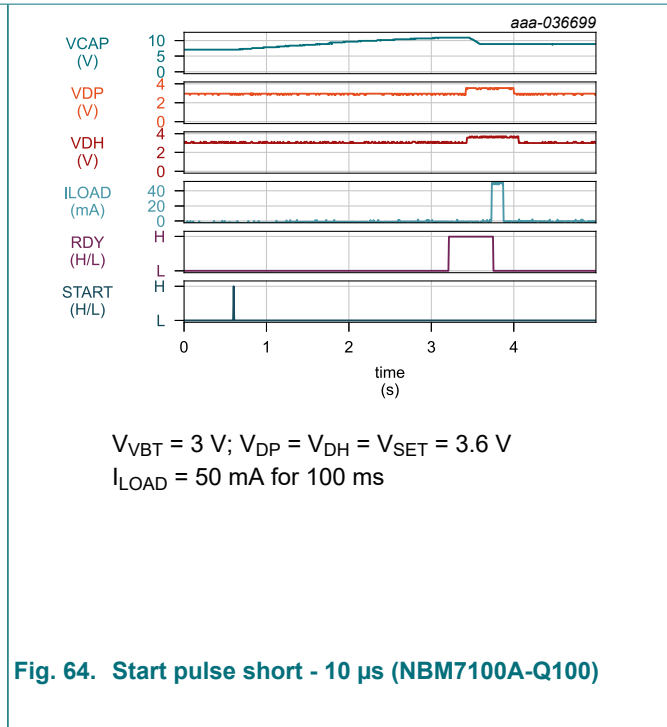
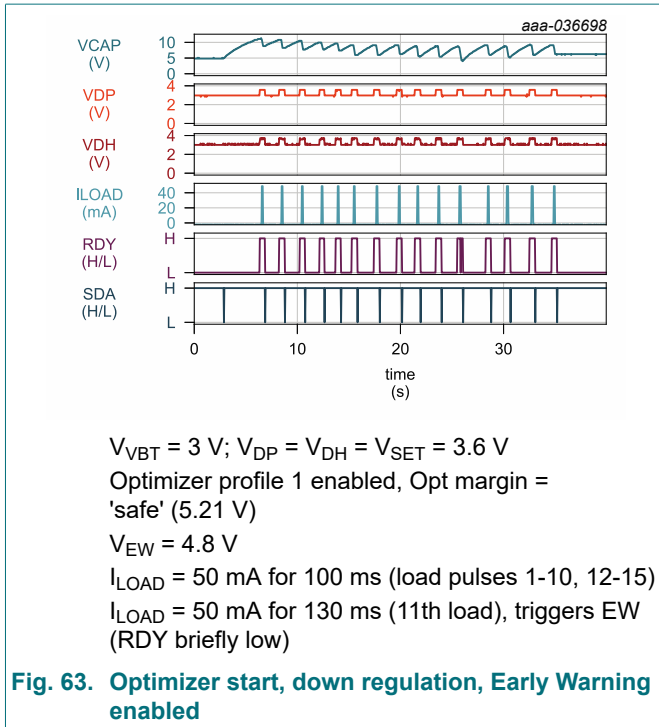

11.11. Power supply recommendations

The device is designed to operate from a battery with a voltage range of 2.4 V to 5.5 V. V_{VBT} should connect directly to the positive battery terminal with a bypass capacitor of C_{VBT} (see Section 7.5). In most situations, using an input capacitance (C_{VBT}) of 1 μF is sufficient to prevent the supply voltage from dipping during device operation.

12. Layout

Layout guidelines

Improper layout can cause unstable operation, load regulation problems, increased ripple and noise. For best performance, all traces should be kept short.

The C_{VBT} , C_{VDH} , C_{STORE} , and C_{VDP} capacitors must be placed close to the device to minimize the effects that parasitic trace inductances may have on normal operation.

The DC-DC converter has two loops: boost mode from VBT to CAP and buck mode from CAP to VDH. For optimal performance, loop areas should be as small as possible.

Serial bus line routing is least critical, however, avoid running serial bus traces near or under the DC-DC converter loops.

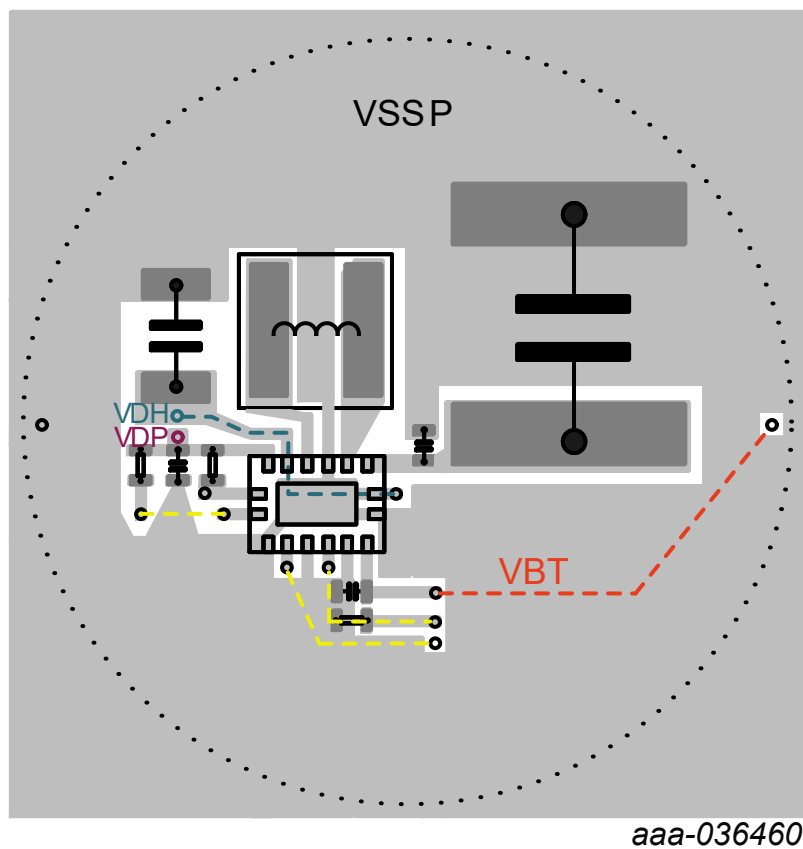

Circle indicates CR2032 diameter

Fig. 67. layout example

13. Package information

13.1. Package outline

DHVQFN16: plastic dual in-line compatible thermal enhanced very thin quad flat package; no leads; 16 terminals; body 2.5 x 3.5 x 0.85 mm

SOT763-1

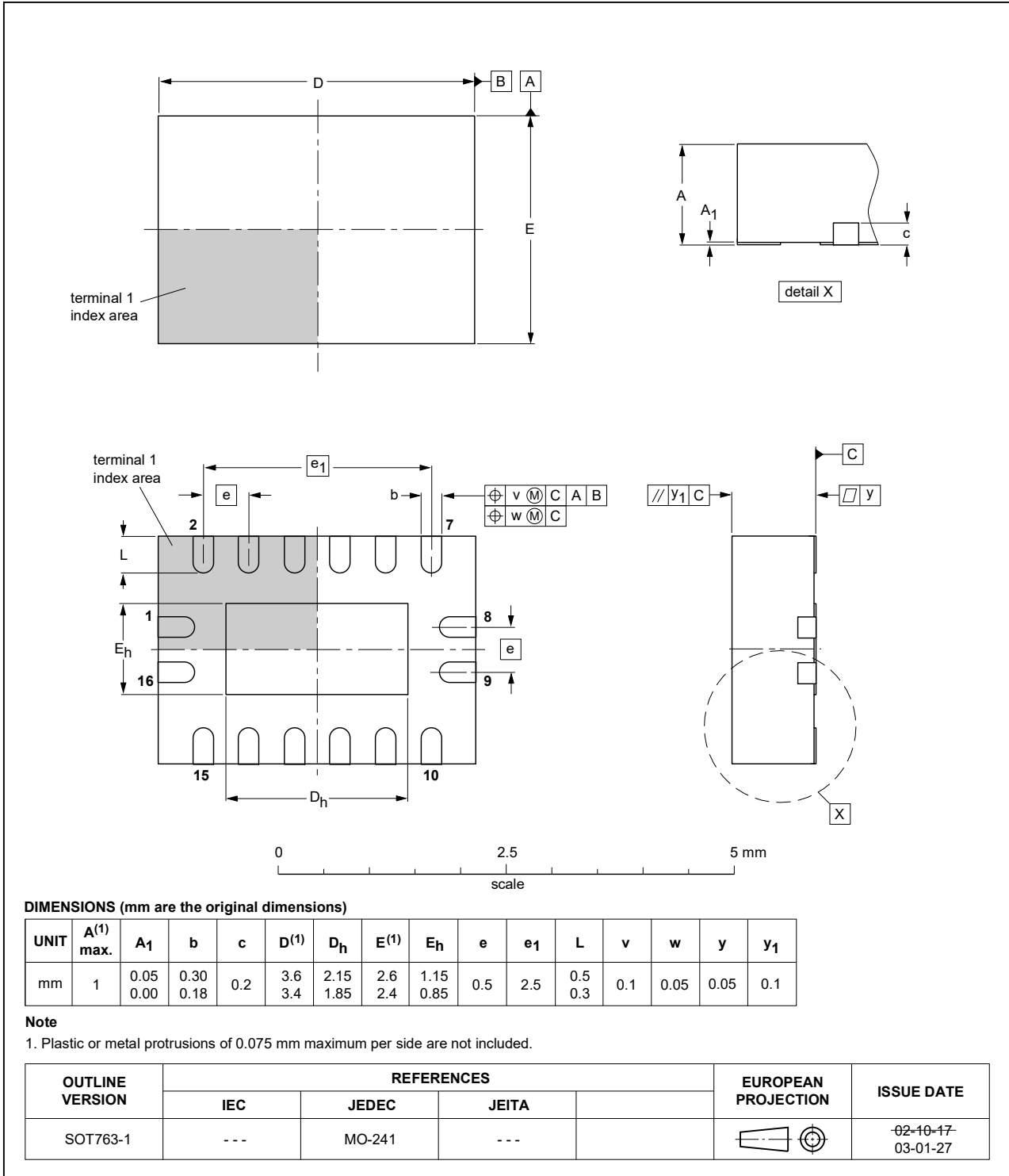

Fig. 68. Package outline SOT763-1 (DHVQFN16)

14. Revision history

Table 41. Revision history

Document ID	Release date	Data sheet status	Change notice	Supersedes
NBM7100_Q100 v.1	20240913	Product data sheet	-	-

15. Legal information

Data sheet status

Document status [1][2]	Product status [3]	Definition
Objective [short] data sheet	Development	This document contains data from the objective specification for product development.
Preliminary [short] data sheet	Qualification	This document contains data from the preliminary specification.
Product [short] data sheet	Production	This document contains the product specification.

- [1] Please consult the most recently issued document before initiating or completing a design.
- [2] The term 'short data sheet' is explained in section "Definitions".
- [3] The product status of device(s) described in this document may have changed since this document was published and may differ in case of multiple devices. The latest product status information is available on the internet at <https://www.nexperia.com>.

Definitions

Draft — The document is a draft version only. The content is still under internal review and subject to formal approval, which may result in modifications or additions. Nexperia does not give any representations or warranties as to the accuracy or completeness of information included herein and shall have no liability for the consequences of use of such information.

Short data sheet — A short data sheet is an extract from a full data sheet with the same product type number(s) and title. A short data sheet is intended for quick reference only and should not be relied upon to contain detailed and full information. For detailed and full information see the relevant full data sheet, which is available on request via the local Nexperia sales office. In case of any inconsistency or conflict with the short data sheet, the full data sheet shall prevail.

Product specification — The information and data provided in a Product data sheet shall define the specification of the product as agreed between Nexperia and its customer, unless Nexperia and customer have explicitly agreed otherwise in writing. In no event however, shall an agreement be valid in which the Nexperia product is deemed to offer functions and qualities beyond those described in the Product data sheet.

Disclaimers

Limited warranty and liability — Information in this document is believed to be accurate and reliable. However, Nexperia does not give any representations or warranties, expressed or implied, as to the accuracy or completeness of such information and shall have no liability for the consequences of use of such information. Nexperia takes no responsibility for the content in this document if provided by an information source outside of Nexperia.

In no event shall Nexperia be liable for any indirect, incidental, punitive, special or consequential damages (including - without limitation - lost profits, lost savings, business interruption, costs related to the removal or replacement of any products or rework charges) whether or not such damages are based on tort (including negligence), warranty, breach of contract or any other legal theory.

Notwithstanding any damages that customer might incur for any reason whatsoever, Nexperia's aggregate and cumulative liability towards customer for the products described herein shall be limited in accordance with the Terms and conditions of commercial sale of Nexperia.

Right to make changes — Nexperia reserves the right to make changes to information published in this document, including without limitation specifications and product descriptions, at any time and without notice. This document supersedes and replaces all information supplied prior to the publication hereof.

Suitability for use in automotive applications — This Nexperia product has been qualified for use in automotive applications. Unless otherwise agreed in writing, the product is not designed, authorized or warranted to be suitable for use in life support, life-critical or safety-critical systems or

equipment, nor in applications where failure or malfunction of an Nexperia product can reasonably be expected to result in personal injury, death or severe property or environmental damage. Nexperia and its suppliers accept no liability for inclusion and/or use of Nexperia products in such equipment or applications and therefore such inclusion and/or use is at the customer's own risk.

Quick reference data — The Quick reference data is an extract of the product data given in the Limiting values and Characteristics sections of this document, and as such is not complete, exhaustive or legally binding.

Applications — Applications that are described herein for any of these products are for illustrative purposes only. Nexperia makes no representation or warranty that such applications will be suitable for the specified use without further testing or modification.

Customers are responsible for the design and operation of their applications and products using Nexperia products, and Nexperia accepts no liability for any assistance with applications or customer product design. It is customer's sole responsibility to determine whether the Nexperia product is suitable and fit for the customer's applications and products planned, as well as for the planned application and use of customer's third party customer(s). Customers should provide appropriate design and operating safeguards to minimize the risks associated with their applications and products.

Nexperia does not accept any liability related to any default, damage, costs or problem which is based on any weakness or default in the customer's applications or products, or the application or use by customer's third party customer(s). Customer is responsible for doing all necessary testing for the customer's applications and products using Nexperia products in order to avoid a default of the applications and the products or of the application or use by customer's third party customer(s). Nexperia does not accept any liability in this respect.

Limiting values — Stress above one or more limiting values (as defined in the Absolute Maximum Ratings System of IEC 60134) will cause permanent damage to the device. Limiting values are stress ratings only and (proper) operation of the device at these or any other conditions above those given in the Recommended operating conditions section (if present) or the Characteristics sections of this document is not warranted. Constant or repeated exposure to limiting values will permanently and irreversibly affect the quality and reliability of the device.

Terms and conditions of commercial sale — Nexperia products are sold subject to the general terms and conditions of commercial sale, as published at <http://www.nexperia.com/profile/terms>, unless otherwise agreed in a valid written individual agreement. In case an individual agreement is concluded only the terms and conditions of the respective agreement shall apply. Nexperia hereby expressly objects to applying the customer's general terms and conditions with regard to the purchase of Nexperia products by customer.

No offer to sell or license — Nothing in this document may be interpreted or construed as an offer to sell products that is open for acceptance or the grant, conveyance or implication of any license under any copyrights, patents or other industrial or intellectual property rights.

Export control — This document as well as the item(s) described herein may be subject to export control regulations. Export might require a prior authorization from competent authorities.

Translations — A non-English (translated) version of a document is for reference only. The English version shall prevail in case of any discrepancy between the translated and English versions.

Trademarks

Notice: All referenced brands, product names, service names and trademarks are the property of their respective owners.

Contents

1. General description	1
2. Features and benefits	1
3. Applications	1
4. Ordering information	2
5. Marking	2
6. Pin configuration and description	2
6.1. Pin configuration.....	2
6.2. Pin description.....	3
7. Specifications	4
7.1. Limiting values.....	4
7.2. ESD ratings.....	4
7.3. Thermal information.....	4
7.4. Recommended operating conditions.....	4
7.5. Recommended components.....	5
7.6. Electrical characteristics.....	5
7.7. Dynamic characteristics.....	7
7.8. Typical characteristics.....	9
7.9. Timing diagrams.....	16
7.10. Test circuits.....	18
8. Detailed description	19
8.1. Functional diagram.....	19
8.2. Overview.....	19
8.3. Operating modes.....	23
8.3.1. Mode overview.....	23
8.3.2. Continuous mode.....	24
8.3.3. On-demand mode.....	24
8.3.4. Auto mode (NBM7100A-Q100 only).....	24
8.4. Feature description.....	25
8.4.1. Chip control.....	25
8.4.2. States of operation.....	27
8.4.3. DC-DC converter.....	30
8.4.4. VDP and VDH output configuration	31
8.4.5. Adaptive power optimization.....	33
8.4.6. Fuel Gauge.....	36
9. Register map	37
10. Programming Tables	38
10.1. Status information	38
10.2. Mode controls.....	38
10.3. VDH Output voltage control (V_{SET}).....	39
10.4. Capacitor end-of-charge voltage (V_{FIX}).....	39
10.5. Capacitor maximum storage voltage ($V_{CAP(MAX)}$).....	40
10.6. VBT pin minimum input voltage comparator threshold (V_{MIN})	40
10.7. Capacitor charge current (I_{CH})	40
10.8. CAP pin input voltage comparator Early Warning voltage (V_{EW}).....	41
10.9. VDH switch configuration	41
10.10. Optimizer profile selection	41
10.11. Optimization margin voltage.....	42
10.12. Fuel gauge	42
10.13. Storage capacitor voltage status (V_{CAP}).....	43
11. Application and implementation	44
11.1. Application information.....	44
11.2. Typical application.....	44
11.3. DC-DC switching frequency and inductor selection.....	45
11.4. Output voltage setting, V_{SET}	45
11.5. Input capacitor, C_{VBT} and charge current, I_{CH} setting.....	45
11.6. Output capacitors, C_{VDP} and C_{VDH}	45
11.7. Storage capacitor, C_{STORE}	46
11.8. External resistors.....	46
11.9. Suggestions for controlling NBM7100A/B-Q100 via serial interface.....	47
11.10. Application curves.....	48
11.11. Power supply recommendations.....	51
12. Layout	52
13. Package information	53
13.1. Package outline.....	53
14. Revision history	54
15. Legal information	55

© Nexperia B.V. 2024. All rights reserved

For more information, please visit: <http://www.nexperia.com>

For sales office addresses, please send an email to: salesaddresses@nexperia.com

Date of release: 13 September 2024