

NAIS

FLAT/VERTICAL TYPE HIGH POWER BIFURCATED CONTACT

NC-RELAYS

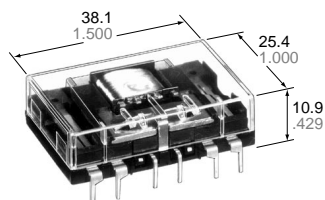

4C Flat type

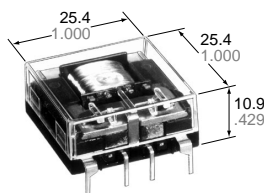

2C Flat type

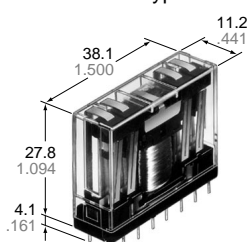

4C Vertical type (PC board)

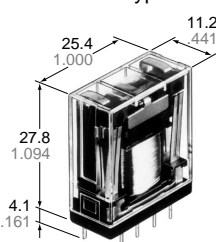

2C Vertical type (PC board)

mm inch

FEATURES

- Space saver — Flat series and vertical series
- High contact reliability due to bifurcated contacts
— 2C: 5 A 250 V AC, 4C: 5 A 125 V AC, 4 A 250 V AC
- Latching types available
- Low operating power
— 2C: 200 mW, 4C: 400 mW (Single side stable)
- Soldering flux inflow prevented by terminal location
- Amber sealed types available
- High breakdown voltage for transient protection
— 1,000 Vrms between open contacts, contact sets

SPECIFICATIONS

Contacts

Types		Standard	Amber sealed
Arrangement		2 Form C, 4 Form C	
Initial contact resistance, max. (By voltage drop 6 V DC 1 A)		50 mΩ	
Rating (resistive load)	Max. switching power	2C: 1,250 VA 150 W 4C: 1,000 VA 150 W	2C: 750 VA 150 W 4C: 500 VA 150 W
	Max. switching voltage	250 V AC	
	Max. switching current	5 A	
	Max. switching carrying current	5 A	
	Min. switching power	100 μA 1 V DC	
Expected life (minimum)	2C	10 ⁵ at 5 A 250 V AC 5 × 10 ⁵ at 5 A 30 V DC	10 ⁵ at 3 A 250 V AC 5 × 10 ⁵ at 5 A 30 V DC
	4C	10 ⁵ at 4 A 250 V AC 5 × 10 ⁵ at 5 A 30 V DC	10 ⁵ at 2 A 250 V AC 5 × 10 ⁵ at 5 A 30 V DC
Contact material		Gold-clad silver nickel	

Coil (Polarized) (at 25°C 77°F)

		Up to 48 V DC	110 V DC
Minimum operating power	2 C single side stable	Approx. 200 mW	500 mW
	4 C single side stable	Approx. 400 mW	500 mW
Nominal operating power	2 C single side stable	Approx. 360 mW	900 mW
	4 C single side stable	Approx. 720 mW	900 mW
Minimum set and reset power	2 C 2 coil latching	Approx. 450 mW	
	4 C 2 coil latching	Approx. 900 mW	
Nominal set and reset power	2 C 2 coil latching	Approx. 800 mW	
	4 C 2 coil latching	Approx. 1,600 mW	

Characteristics (at 25°C 77°F 50% Relative humidity)

Max. operating speed		180 cpm	
Initial insulation resistance		Min. 100 MΩ at 500 V DC	
Initial breakdown voltage*1	Between open contacts, contact sets	1,000 Vrms	
	Between contacts and coil	2,000 Vrms	
Operate time (at nominal voltage)		Approx. 6 ms	
Release time (at nominal voltage)		Approx. 3 ms	
Operate time (latching) (at nominal voltage)		Approx. 6 ms	
Reset time (latching) (at nominal voltage)		Approx. 6 ms	
Temperature rise (at nominal voltage)		Max. 65°C	
Shock resistance	Functional*2	Min. 98 m/s ² {10 G}	
	Destructive*3	Min. 980 m/s ² {100 G}	
Vibration resistance	Functional*4	58.8 m/s ² {6 G}, 10 to 55 Hz at double amplitude of 1 mm	
	Destructive	117.6 m/s ² {12 G}, 10 to 55 Hz at double amplitude of 2 mm	
Conditions for operation, transport and storage*5 (Not freezing and condensing at low temperature)	(Single side stable)	2 C	up to 48 V DC: -40°C to +70°C -40°F to +158°F 110 V DC: -40°C to +55°C -40°F to +131°F
		4 C	-40°C to +55°C -40°F to +131°F
	(2 coil latching)	-40°C to +55°C -40°F to +131°F	
	Humidity	5 to 85% R.H.	
Unit weight		2C/Approx. 16 g .56 oz 4C/Approx. 18 g .63 oz	

Remarks

- * Specifications will vary with foreign standards certification ratings.
 *1 Detection current: 10 mA
 *2 Half-wave pulse of sine wave: 11ms; detection time: 10μs
 *3 Half-wave pulse of sine wave: 6ms
 *4 Detection time: 10μs
 *5 Refer to 5. Conditions for operation, transport and storage mentioned in AMBIENT ENVIRONMENT (Page 61).

TYPICAL APPLICATIONS

Use NC Relays for power control up to 5 A or —
 Tape recorders, temperature controls, video tape recorders
 Telecommunications equipment, measuring controls, copiers
 Date processing equipment, computer peripherals
 Automatic vendors, copiers, automatic storage controls, N.C. machines

ORDERING INFORMATION

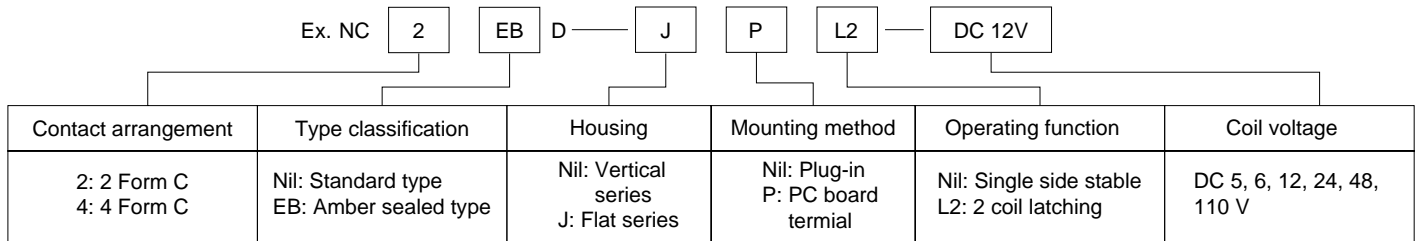

- (Notes) 1. Flat series are available in PC board terminal types only.
 2. For VDE recognized type, add suffix VDE.
 3. Standard packing Carton: 20 pcs. Case: 200 pcs.
 4. UL/CSA, approved type is standard.

TYPE AND COIL DATA (at 20°C 68°F) (Coil data for Amber sealed types are same as those for standard types.)

2 Form C Single side stable

Flat series	Vertical series		Coil voltage, V DC			Coil resistance, Ω (±10%)	Nominal operating power, mW
	PC board terminal	Plug-in	PC board terminal	Pick-up voltage (max.)	Drop-out voltage (min.)		
NC2D-JP-DC5V	NC2D-DC5V	NC2D-P-DC5V	4.0	0.5	6.75	69.4	360
NC2D-JP-DC6V	NC2D-DC6V	NC2D-P-DC6V	4.8	0.6	8.1	100	
NC2D-JP-DC12V	NC2D-DC12V	NC2D-P-DC12V	9.6	1.2	16.2	400	
NC2D-JP-DC24V	NC2D-DC24V	NC2D-P-DC24V	19.2	2.4	32.4	1,600	
NC2D-JP-DC48V	NC2D-DC48V	NC2D-P-DC48V	38.4	4.8	64.8	6,400	
NC2D-JP-DC110V	NC2D-DC110V	NC2D-P-DC110V	88.0	11.0	121	13,500	900

2 Form C 2 coil latching

Flat series	Vertical series		Coil voltage, V DC			Coil resistance, Ω (±10%)	Nominal operating power, mW
	PC board terminal	Plug-in	PC board terminal	Pick-up voltage (max.)	Reset voltage (max.)		
NC2D-JPL2-DC5V	NC2D-L2-DC5V	NC2D-PL2-DC5V	4.0	4.0	5.5	31.3	800
NC2D-JPL2-DC6V	NC2D-L2-DC6V	NC2D-PL2-DC6V	4.8	4.8	6.6	45.0	
NC2D-JPL2-DC12V	NC2D-L2-DC12V	NC2D-PL2-DC12V	9.6	9.6	13.2	180	
NC2D-JPL2-DC24V	NC2D-L2-DC24V	NC2D-PL2-DC24V	19.2	19.2	26.4	720	
NC2D-JPL2-DC48V	NC2D-L2-DC48V	NC2D-PL2-DC48V	38.4	38.4	52.8	2,880	
NC2D-JPL2-DC110V	NC2D-L2-DC110V	NC2D-PL2-DC110V	88.0	88.0	121	15,125	

4 Form C Single side stable

Flat series	Vertical series		Coil voltage, V DC			Coil resistance, Ω (±10%)	Nominal operating power, mW
	PC board terminal	Plug-in	PC board terminal	Pick-up voltage (max.)	Drop-out voltage (min.)		
NC4D-JP-DC5V	NC4D-DC5V	NC4D-P-DC5V	4.0	0.5	5.5	34.7	720
NC4D-JP-DC6V	NC4D-DC6V	NC4D-P-DC6V	4.8	0.6	6.6	50	
NC4D-JP-DC12V	NC4D-DC12V	NC4D-P-DC12V	9.6	1.2	13.2	200	
NC4D-JP-DC24V	NC4D-DC24V	NC4D-P-DC24V	19.2	2.4	26.4	800	
NC4D-JP-DC48V	NC4D-DC48V	NC4D-P-DC48V	38.4	4.8	52.8	3,200	
NC4D-JP-DC110V	NC4D-DC110V	NC4D-P-DC110V	88.0	11.0	121	13,500	900

4 Form C 2 coil latching

Flat series	Vertical series		Coil voltage, V DC			Coil resistance, Ω ($\pm 10\%$)	Nominal operating power, mW
	PC board terminal	Plug-in	PC board terminal	Pick-up voltage (max.)	Reset voltage (max.)		
NC4D-JPL2-DC5V	NC4D-L2-DC5V	NC4D-PL2-DC5V	4.0	4.0	5.5	15.6	1,600
NC4D-JPL2-DC6V	NC4D-L2-DC6V	NC4D-PL2-DC6V	4.8	4.8	6.6	22.5	
NC4D-JPL2-DC12V	NC4D-L2-DC12V	NC4D-PL2-DC12V	9.6	9.6	13.2	90	
NC4D-JPL2-DC24V	NC4D-L2-DC24V	NC4D-PL2-DC24V	19.2	19.2	26.4	360	
NC4D-JPL2-DC48V	NC4D-L2-DC48V	NC4D-PL2-DC48V	38.4	38.4	52.8	1,440	
NC4D-JPL2-DC110V	NC4D-L2-DC110V	NC4D-PL2-DC110V	88.0	88.0	121	7,560	

Notes:

- Two coil latching relay 4C series are for intermittent operation only. Power should be applied to coil continuously for no more than two minutes.
- Coil resistance is the measured value at a coil temperature of 20°C. Compensate coil resistance by plus or minus 0.4% for each degree (°C) of coil temperature change.
- "Maximum allowable voltage" is that value at maximum contact rating and maximum ambient temperature. The graph shown in the data describes the inter-relationship; care should be taken to prevent the total of ambient temperature and the coil temperature rise from exceeding 120°C.

DIMENSIONS

mm inch

Flat series

2C single side stable
(NC2D-JP)

Standard type

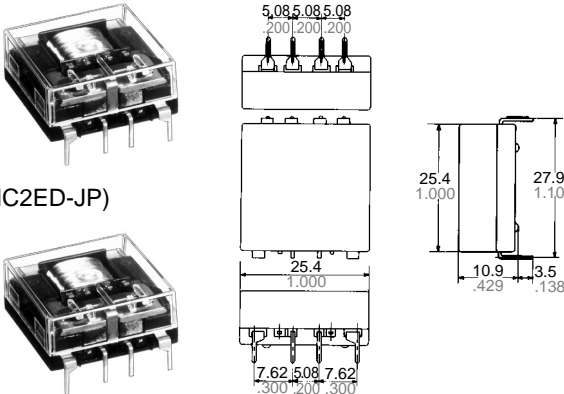

Amber sealed type

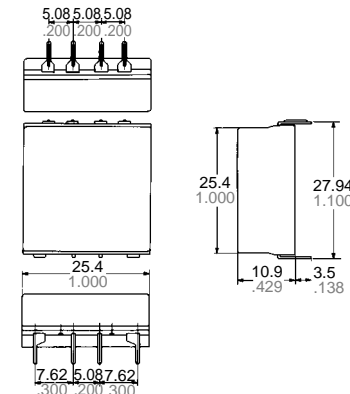

PC board pattern (Copper-side view)

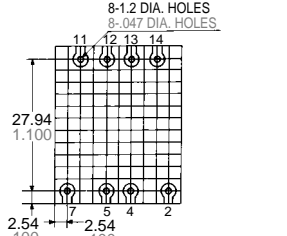

8-1.2 DIA. HOLES
8-.047 DIA. HOLES

Tolerance: $\pm 0.1 \pm 0.004$

Schematic (Top view)

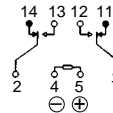

Deenergized position

General tolerance: $\pm 0.5 \pm 0.020$

2C 2 coil latching
(NC2D-JPL2)

Standard type

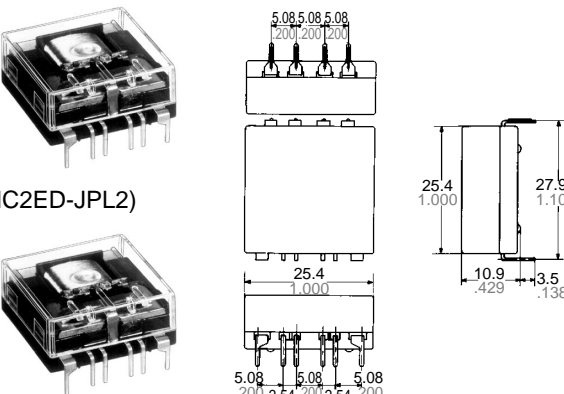

Amber sealed type

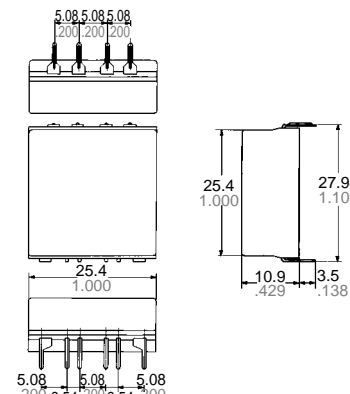

PC board pattern (Copper-side view)

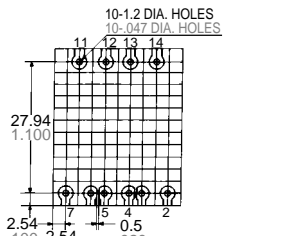

10-1.2 DIA. HOLES
10-.047 DIA. HOLES

Tolerance: $\pm 0.1 \pm 0.004$

Schematic (Top view)

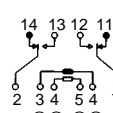

General tolerance: $\pm 0.5 \pm 0.020$

Diagram shows the "reset" position when terminals 3 and 6 are energized. Energize terminals 4 and 5 to transfer contacts.

NC

4C single side stable
(NC4D-JP)

mm inch

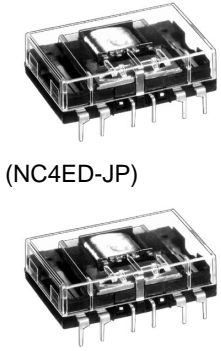

(NC4ED-JP)

Standard type

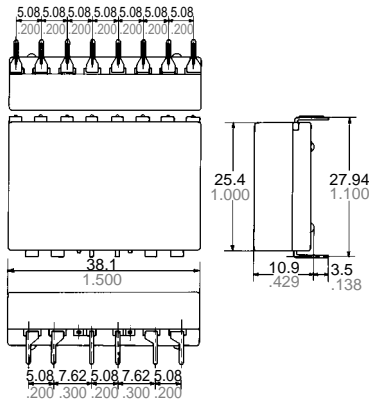

Amber sealed type

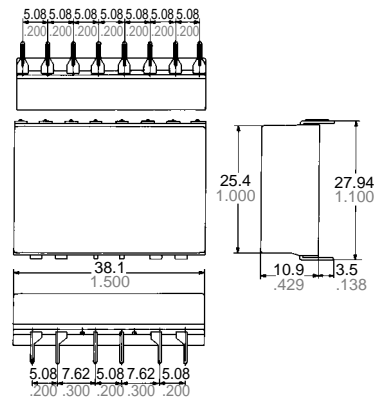

General tolerance: $\pm 0.5 \pm .020$

PC board pattern (Copper-side view)

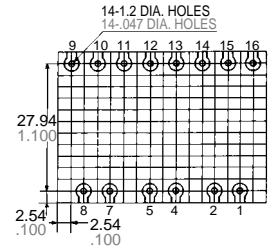

Tolerance: $\pm 0.1 \pm .004$

Schematic (Top view)

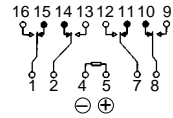

Deenergized position

4C 2 coil latching
(NC4D-JPL2)

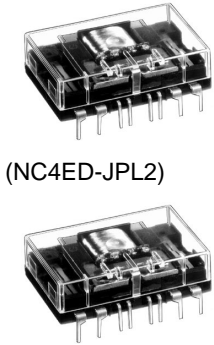

(NC4ED-JPL2)

Standard type

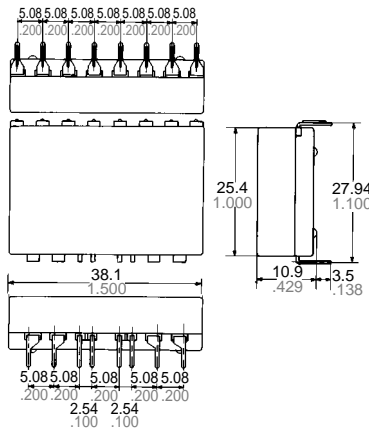

Amber sealed type

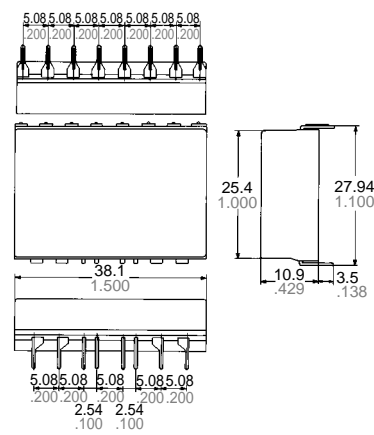

General tolerance: $\pm 0.5 \pm .020$

PC board pattern (Copper-side view)

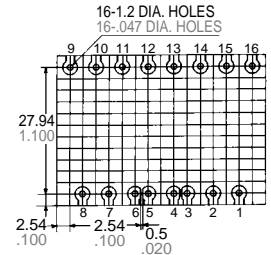

Tolerance: $\pm 0.1 \pm .004$

Schematic (Top view)

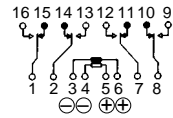
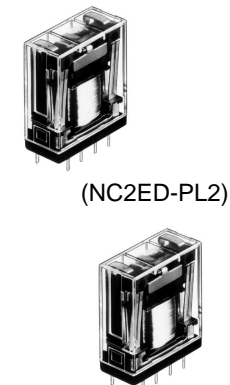

Diagram shows the "reset" position when terminals 3 and 6 are energized. Energize terminals 4 and 5 to transfer contacts.

Slim series

PC board series

2C single side stable
(NC2D-P)



(NC2ED-PL2)

Standard type

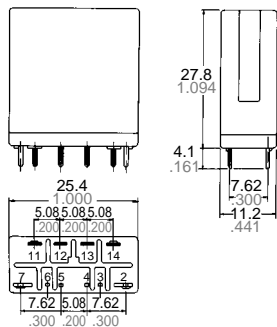

Amber sealed type

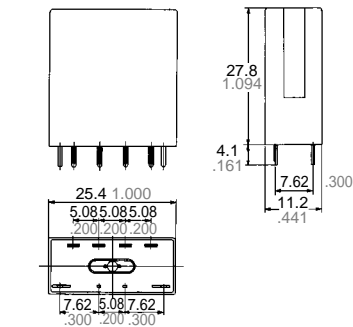

General tolerance: $\pm 0.5 \pm .020$

PC board pattern (Copper-side view)

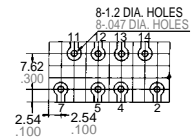

Tolerance: $\pm 0.1 \pm .004$

Schematic (Bottom view)

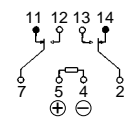

Deenergized position

2C 2 coil latching
(NC2D-PL2)



(NC2ED-P)

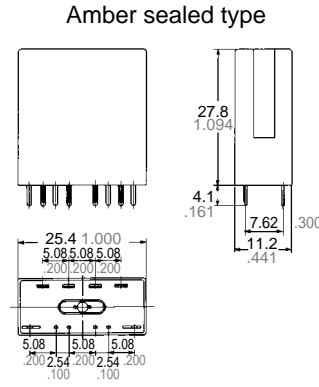
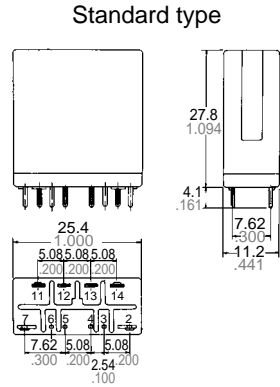

PC board pattern (Copper-side view)

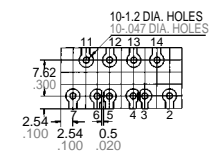

Tolerance: $\pm 0.1 \pm 0.004$

Schematic (Bottom view)

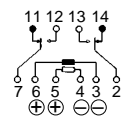
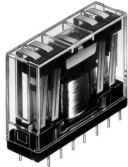

Diagram shows the "reset" position when terminals 3 and 6 are energized. Energize terminals 4 and 5 to transfer contacts.

General tolerance: $\pm 0.5 \pm 0.020$

4C single side stable
(NC4D-P)



(NC4ED-P)

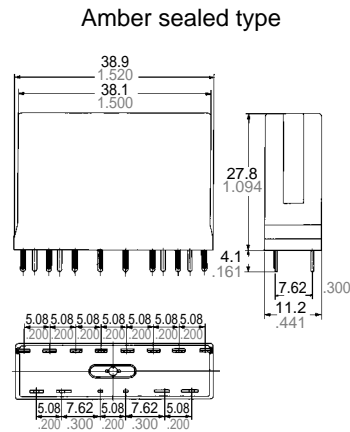
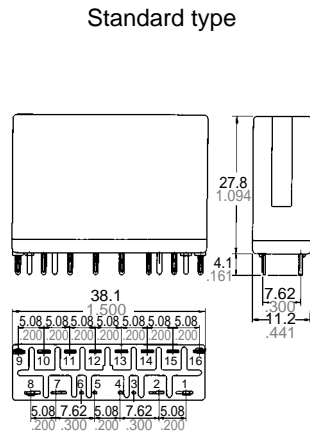
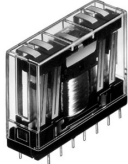

PC board pattern (Copper-side view)

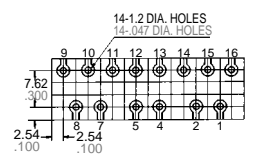

Tolerance: $\pm 0.1 \pm 0.004$

Schematic (Bottom view)

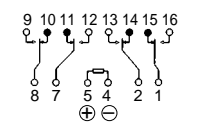

Deenergized position

General tolerance: $\pm 0.5 \pm 0.020$

4C 2 coil latching
(NC4D-PL2)

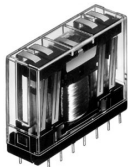

(NC4ED-PL2)

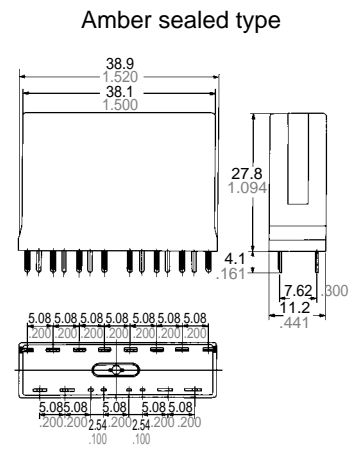
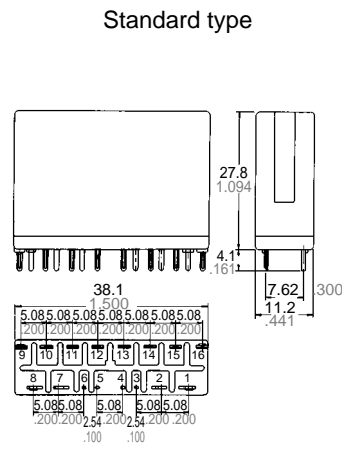
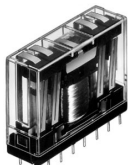

PC board pattern (Copper-side view)

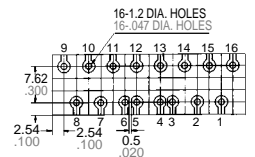

Tolerance: $\pm 0.1 \pm 0.004$

Schematic (Bottom view)

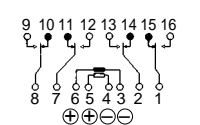
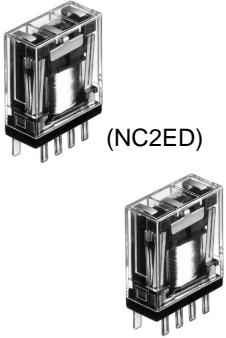

Diagram shows the "reset" position when terminals 3 and 6 are energized. Energize terminals 4 and 5 to transfer contacts.

General tolerance: $\pm 0.5 \pm 0.020$

Slim series
Plug-in series
 2C single side stable
 (NC2ED)



Standard type

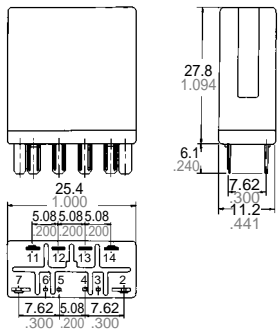

Amber sealed type

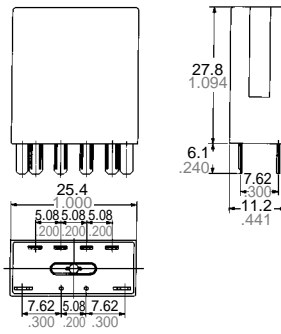

Schematic (Bottom view)

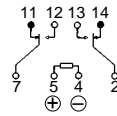

Deenergized position

General tolerance: $\pm 0.5 \pm 0.20$

2C 2 coil latching
 (NC2D-L2)

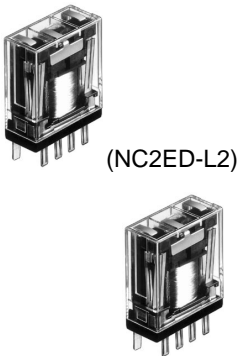

Standard type

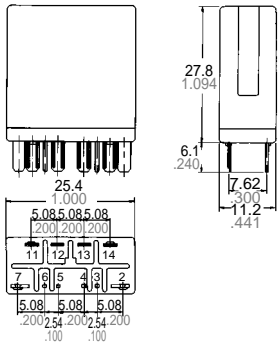

Amber sealed type

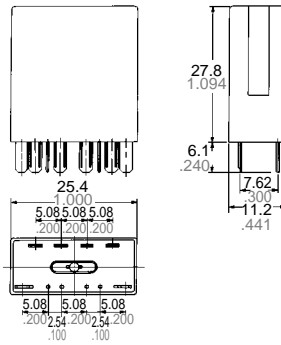

Schematic (Bottom view)

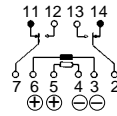
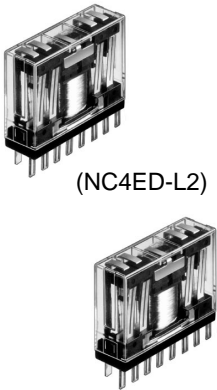

Diagram shows the "reset" position when terminals 3 and 6 are energized. Energize terminals 4 and 5 to transfer contacts.

General tolerance: $\pm 0.5 \pm 0.20$

4C single side stable
 (NC4D)



Standard type

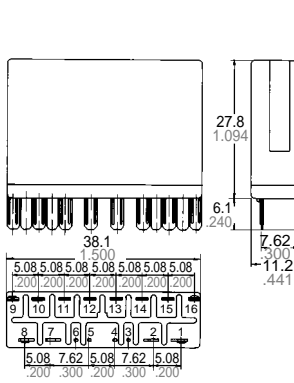

Amber sealed type

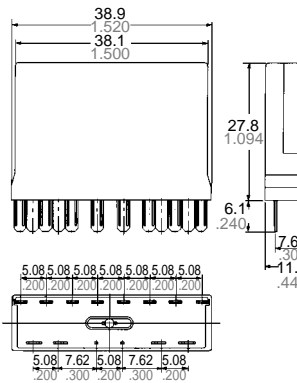

Schematic (Bottom view)

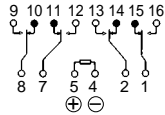

Deenergized position

General tolerance: $\pm 0.5 \pm 0.20$

4C 2 coil latching
 (NC4D-L2)

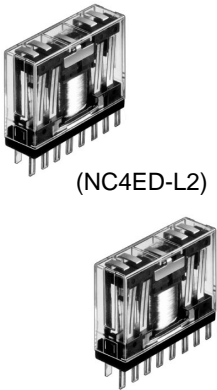

Standard type

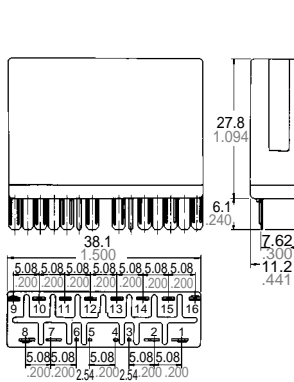

Amber sealed type

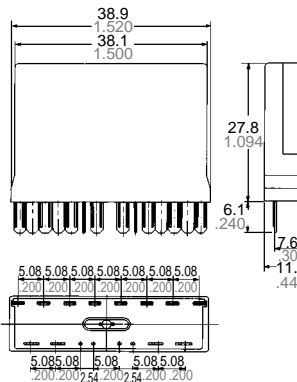

Schematic (Bottom view)

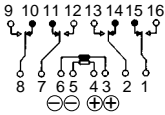

Diagram shows the "reset" position when terminals 3 and 6 are energized. Energize terminals 4 and 5 to transfer contacts.

General tolerance: $\pm 0.5 \pm 0.20$

Schematic

— Energize relays only in the polarities shown —

1. Single side stable

Same operation as conventional magnetic relays.

Contacts will transfer only when coil is energized under indicated polarity.

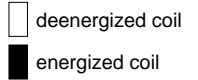

2C

4C

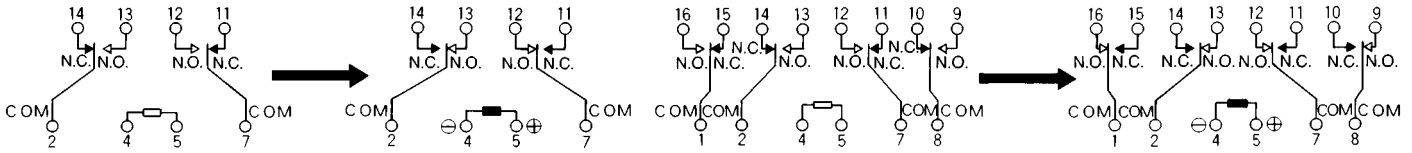

2. 2 coil latching

Contacts will transfer only when coil is energized under indicated polarity.

Once transferred, contacts remain in that position even with power off until opposite coil is energized at indicated polarity.

2C

4C

2C

4C

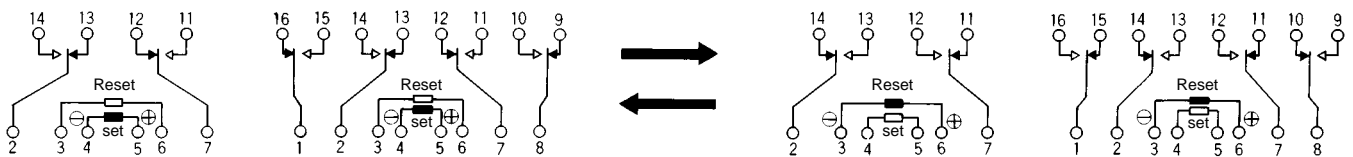

Diagrams show the "set" position when terminals 4 (-) and 5 (+) are energized. When the coil current is switched off, these contacts remain in "make" position.

Energize terminals 3 (-) and 6 (+) to transfer the contacts. Diagrams show the "reset" position when terminals 3 (-) and 6 (+) are energized.

Energize terminals 4 (-) and 5 (+) to transfer the contacts.

REFERENCE DATA

Standard type

1.-(1) Life curve
DC load (2C, 4C)

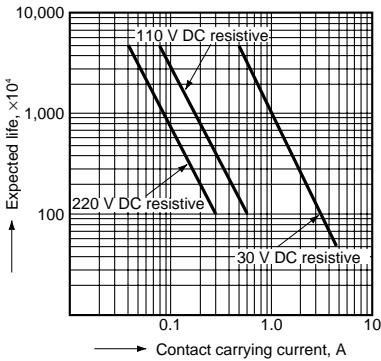

AC load (2C)

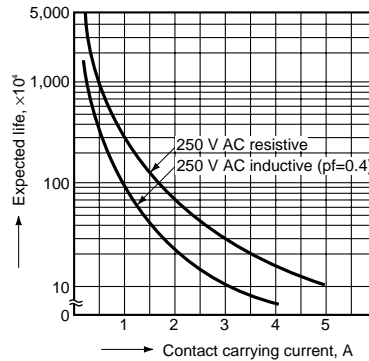

AC load (4C)

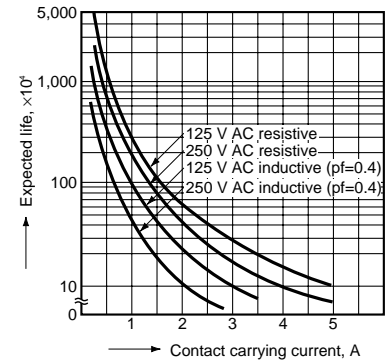

2.-(1) Temperature rise characteristics for single side stable

Measured portion: Inside the coil

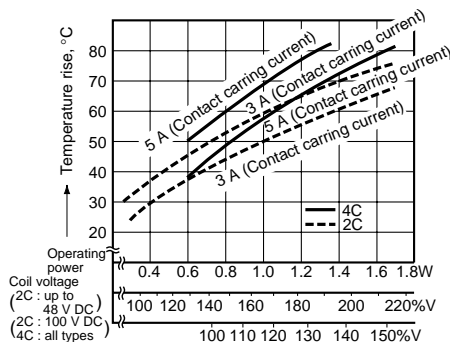

2.-(2) Temperature rise characteristics for 2 coil latching

Measured portion: Inside the coil

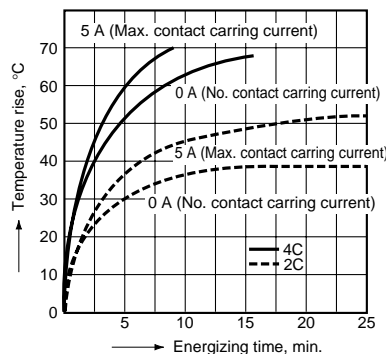

3. Operate time for single side stable

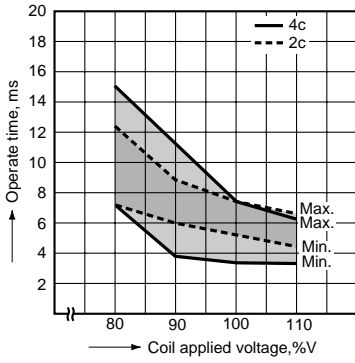

4. Release time for single side stable

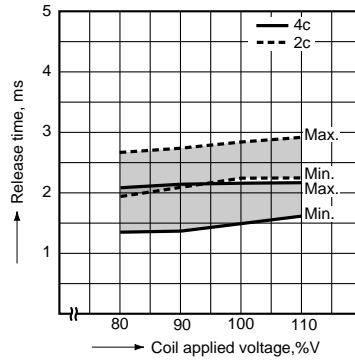

5. Rate of change of pick-up and drop-out voltage 2 Form C single side stable

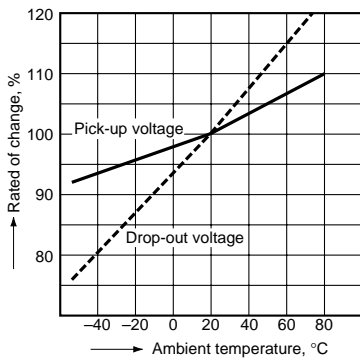

4 Form C single side stable

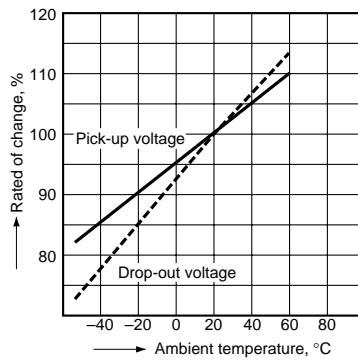

6.-(1) Ambient temperature vs Max. continuous voltage

Sample: NC2D-P-DC24 V (2c slim single side stable)

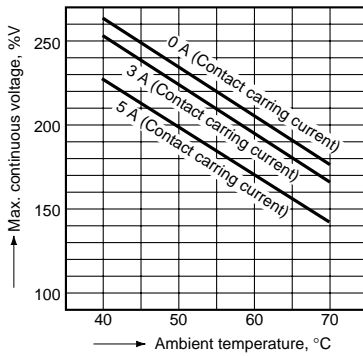

6.-(2) Ambient temperature vs Max. continuous voltage

Sample: NC2D-P-DC110 V (2c slim single side stable), NC4D-P-DC24 V (4c slim single side stable)

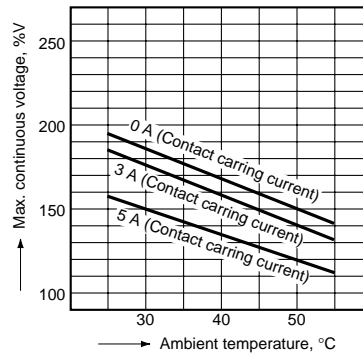

ACCESSORIES

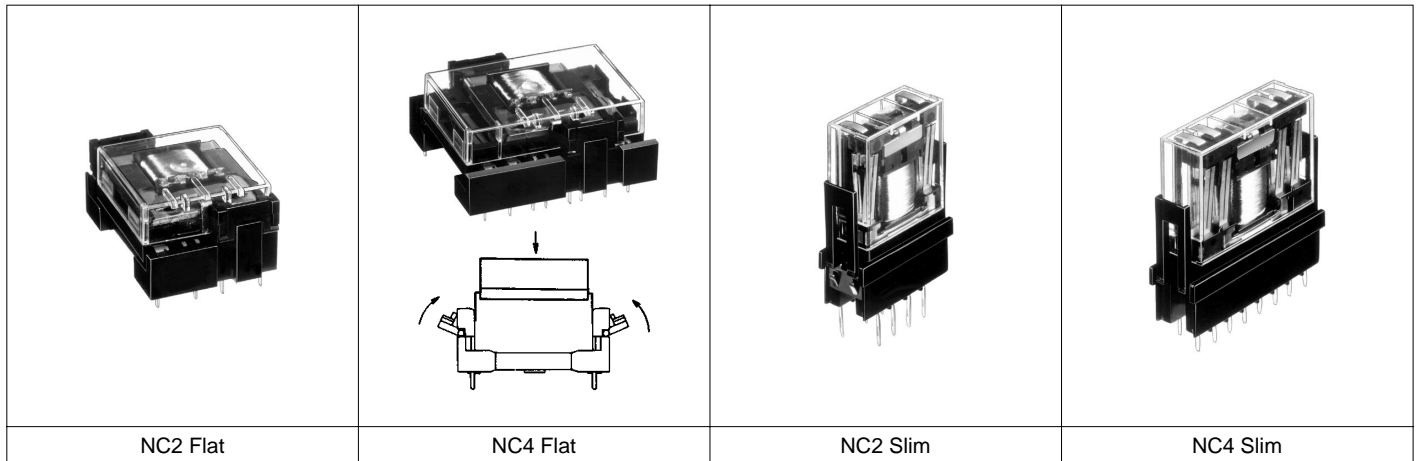

Sockets incorporate a spring clip at each end permitting single "snap-in" attachment to chassis or panels - no screws

necessary. Relays are held firmly in the socket by clips integrally molded into the socket.

TYPES

For Flat series

Part No.	Terminals	Mating relay
NC2-JPS	P/C board	NC2D-JP
NC4-JPS	P/C board	NC4D-JP
NC2-JPL2S	P/C board	NC2D-JPL2
NC4-JPL2S	P/C board	NC4D-JPL2

Standard packing:
Carton: 20 pieces
Case: 200 pieces

For Slim series

Part No.	Terminals	Mating relay
NC2-PS	P/C board	NC2D-P
NC4-PS	P/C board	NC4D-P
NC2-SS	Solder	NC2D
NC4-SS	Solder	NC2D
NC2-L2PS	P/C board	NC4D-PL2
NC4-L2PS	P/C board	NC2D-PL2
NC4-L2SS	Solder	NC2D-L2
NC4-L2SS	Solder	NC4D-L2

SPECIFICATIONS

Maximum continuous current	Flat series: 5 A 250 V AC Slim series: 5 A 250 V AC
Initial breakdown voltage	2,000 V AC (Except for coil-coil of L2 types: 1,500 V AC)
Initial insulation resistance	100 MΩ at 500 V DC
Heat resistance	150°C (302°F) for one hour

Caution: Do not insert or remove relays while in the energized condition.

DIMENSIONS

mm inch

Flat series

NC2-JPS
NC2-JPL2S

Terminal width: 0.9 .035
Terminal thickness: 0.4 .016

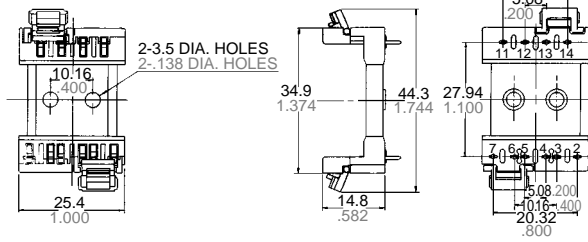

Terminal portion

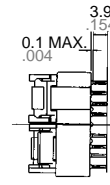

PC board pattern
(copper-side view)

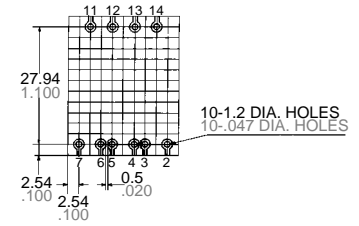

Terminals 3 and 6 excluded for NC2-JPS.

General tolerance: $\pm 0.5 \pm .020$

Tolerance: $\pm 0.1 \pm .004$

NC4-JPS
NC4-JPL2S

Terminal width: 0.9 .035
Terminal thickness: 0.4 .016

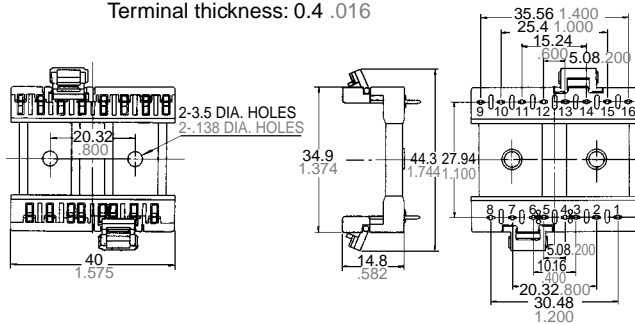

Terminal portion

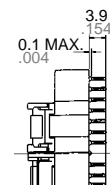

PC board pattern
(copper-side view)

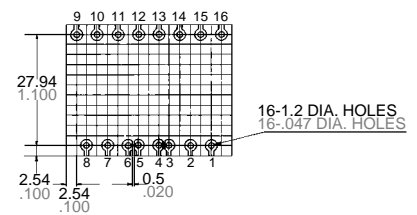

Terminals 3 and 6 excluded for NC4-JPS.

General tolerance: $\pm 0.5 \pm .020$

Tolerance: $\pm 0.1 \pm .004$

Slim series

NC2-SS
NC2-L2S

Terminal width: 1.9 .075
Terminal thickness: 0.4 .016

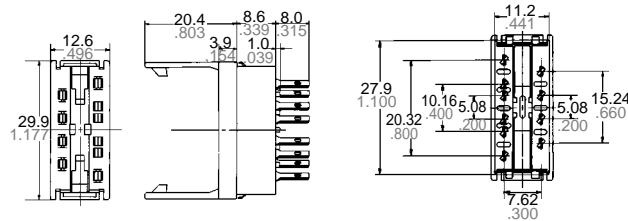

Chassis cutout

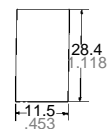

Chassis thickness range: 1.0 to 2.0
.039 to .079

Terminals 3 and 6 excluded for NC2-SS.

General tolerance: $\pm 0.5 \pm .020$

NC2-PS
NC2-L2P

Terminal width: 0.9 .035
Terminal thickness: 0.4 .016

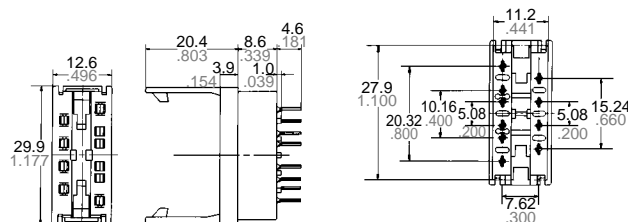

PC board pattern
(copper-side view)

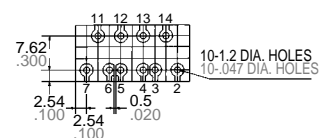

Terminals 3 and 6 excluded for NC2-PS.

General tolerance: $\pm 0.5 \pm .020$

Tolerance: $\pm 0.1 \pm .004$

NC4-SS
NC4-L2S

Terminal width: 1.9 .075
Terminal thickness: 0.4 .016

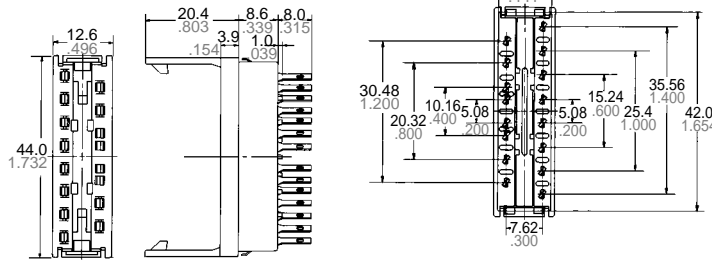
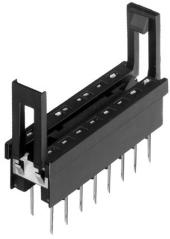

Chassis cutout

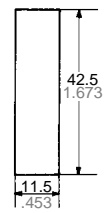

Chassis thickness range: 1.0 to 2.0
.039 to .079

Terminals 3 and 6 excluded for NC4-SS.

General tolerance: $\pm 0.5 \pm .020$

NC4-PS
NC4-L2P

Terminal width: 0.9 .035
Terminal thickness: 0.4 .016

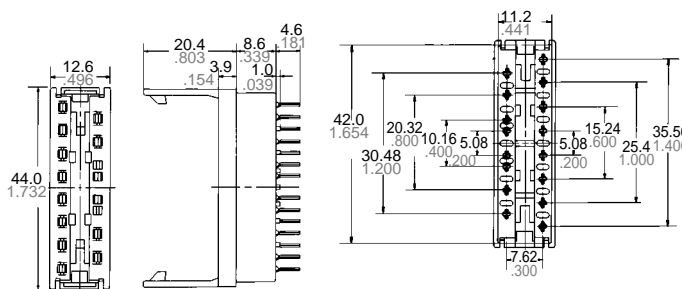

PC board pattern
(copper-side view)

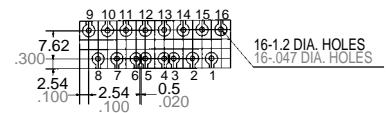

Terminals 3 and 6 excluded for NC4-PS.

General tolerance: $\pm 0.5 \pm .020$

Tolerance: $\pm 0.1 \pm .004$

NOTES

1. To maintain insulation between coils of 2 coil latching series, terminals 5 and 6 for flat series, and terminals 3 and 4 for slim series should be connected to provide common return.

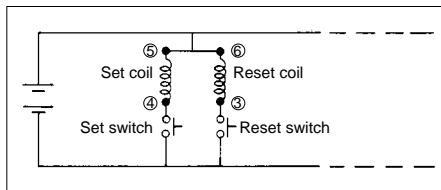

2. 2 coil latching series 4C are for intermittent operation only. Power should be applied to coils continuously for no more than two minutes.

3. When designing printed circuit board patterns, note that:

(1) "Top View" wiring diagram is indicated for the Flat series because terminals can be seen from above.

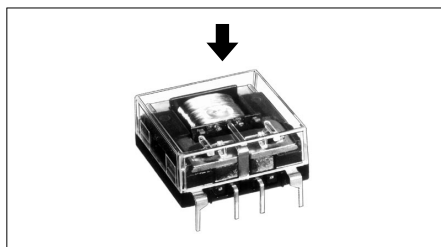

(2) "Bottom View" wiring diagram is indicated for the Slim series because terminals can not be seen from above.

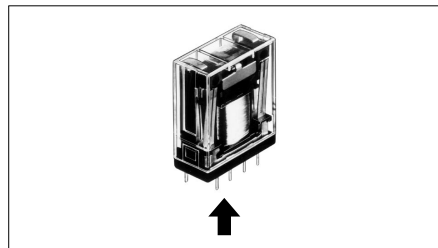

4. When using slim series in close proximity, mount all relays facing the same direction.

Different mounting directions may cause change in the relay characteristics because NC relays are polarized.

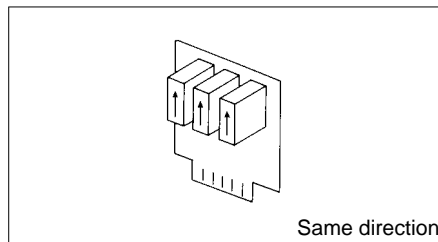

5. Sockets

- (1) When PC board series are used with socket, do not apply loads exceeding 3 A.
- (2) Soldering should be done quickly to avoid damaging the thermoplastic body.
- (3) Insulation will be optimum when wire connections are soldered as shown with all slim sockets.

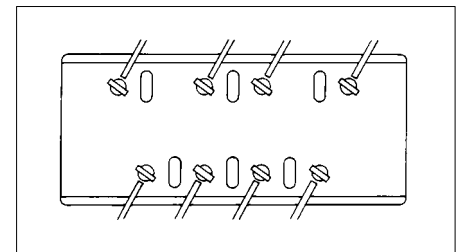

For Cautions for Use, see Relay Technical Information (Page 48 to 76).