

NC7WBD3306 TinyLogic® UHS 2-Bit Low Power Bus Switch with Level Shifting

General Description

The NC7WBD3306 is a 2-bit ultra high-speed CMOS FET bus switch with enhanced level shifting circuitry and with TTL-compatible active LOW control inputs. The low On Resistance of the switch allows inputs to be connected to outputs with minimal propagation delay and without generating additional ground bounce noise. The device is organized as a 2-bit switch with independent bus enable (\overline{OE}) controls. When \overline{OE} is LOW, the switch is ON and Port A is connected to Port B. When \overline{OE} is HIGH, the switch is OPEN and a high-impedance state exists between the two ports. Reduced voltage drive to the gate of the FET switch permits nominal level shifting of 5V to 3V through the switch. Control inputs tolerate voltages up to 5.5V independent of V_{CC} .

Features

- Space saving US8 surface mount package
- MicroPak™ leadless package
- Typical 3Ω switch resistance at 5.0V V_{CC} , $V_{IN} = 0V$
- Level shift facilitates 5V to 3.3V interfacing
- Minimal propagation delay through the switch
- Power down high impedance input/output
- Zero bounce in flow through mode
- TTL compatible active LOW control inputs
- Control inputs are overvoltage tolerant

Ordering Code:

Order Number	Package Number	Product Code Top Mark	Package Description	Supplied As
NC7WBD3306K8X	MAB08A	WB6D	8-Lead US8, JEDEC MO-187, Variation CA 3.1mm Wide	3k Units on Tape and Reel
NC7WBD3306L8X (Preliminary)	MAC08A	P7	8-Lead MicroPak, 1.6 mm Wide	5k Units on Tape and Reel

TinyLogic® is a registered trademark of Fairchild Semiconductor Corporation.
MicroPak™ is a trademark of Fairchild Semiconductor Corporation.

NC7WBD3306 TinyLogic® UHS 2-Bit Low Power Bus Switch with Level Shifting

Logic Diagram

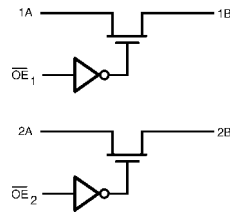

Pin Descriptions

Pin Name	Description
A	Bus A Switch I/O
B	Bus B Switch I/O
\overline{OE}	Bus Enable Input

Function Table

Bus Enable Input (\overline{OE})	Function
L	B Connected to A
H	Disconnected

H = HIGH Logic Level L = LOW Logic Level

Connection Diagrams

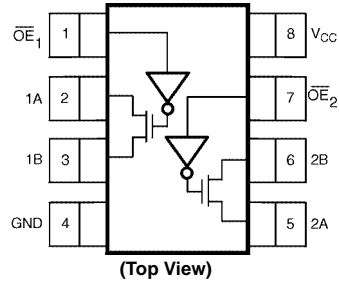

Pin One Orientation Diagram

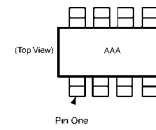

AAA represents Product Code Top Mark - see ordering code

Note: Orientation of Top Mark determines Pin One location. Read the top product code mark left to right, Pin One is the lower left pin (see diagram).

Pad Assignments for MicroPak

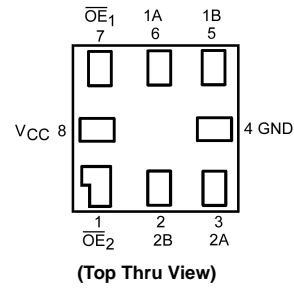

Absolute Maximum Ratings (Note 1)

Supply Voltage (V_{CC})	-0.5V to +7.0V
DC Switch Voltage (V_S)	-0.5V to +7.0V
DC Output Voltage (V_{IN}) (Note 2)	-0.5V to +7.0V
DC Input Diode Current (I_{IK}) $V_{IN} < 0V$	-50 mA
DC Output (I_{OUT}) Sink Current	128 mA
DC V_{CC} or Ground Current (I_{CC}/I_{GND})	± 100 mA
Storage Temperature Range (T_{STG})	-65°C to +150°C
Junction Temperature under Bias (T_J)	+150°C
Junction Lead Temperature (T_L) (Soldering, 10 Seconds)	+260°C
Power Dissipation (P_D) @ +85°C	250 mW

Recommended Operating Conditions (Note 3)

Supply Operating (V_{CC})	4.5V to 5.5V
Control Input Voltage (V_{IN})	0V to 5.5V
Switch Input Voltage (V_{IN})	0V to 5.5V
Switch Output Voltage (V_{OUT})	0V to 5.5V
Operating Temperature (T_A)	-40°C to +85°C
Input Rise and Fall Time (t_r, t_f)	
Control Input	0 ns/V to 5 ns
Switch I/O	0 ns/V to DC
Thermal Resistance (θ_{JA})	250°C/W

Note 1: The "Absolute Maximum Ratings" are those values beyond which the safety of the device cannot be guaranteed. The device should not be operated at these limits. The parametric values defined in the Electrical Characteristics tables are not guaranteed at the absolute maximum ratings. The "Recommended Operating Conditions" table will define the conditions for actual device operation.

Note 2: The input and output negative voltage ratings may be exceeded if the input and output diode current ratings are observed.

Note 3: Unused logic inputs must be held HIGH or LOW. They may not float.

DC Electrical Characteristics

Symbol	Parameter	V_{CC} (V)	$T_A = -40^\circ\text{C to } +85^\circ\text{C}$			Units	Conditions
			Min	Typ	Max		
V_{IK}	Clamp Diode Voltage	4.5			-1.2	V	$I_{IN} = -18$ mA
V_{IH}	HIGH Level Input Voltage	4.5 to 5.5	2.0			V	
V_{IL}	LOW Level Input Voltage	4.5 to 5.5			0.8	V	
V_{OH}	HIGH Level Output Voltage	4.5 to 5.5	see Figure 3			V	$V_{IN} = V_{CC}$
I_{IN}	Input Leakage Current	5.5			± 1.0	μA	$0 \leq V_{IN} \leq 5.5V$
I_{OFF}	Power OFF Leakage Current	5.5			± 1.0	μA	$0 \leq A, B \leq V_{CC}$
R_{ON}	Switch On Resistance (Note 4)	4.5		3	7	Ω	$V_{IN} = 0V, I_{IN} = 64$ mA
				3	7		$V_{IN} = 0V, I_{IN} = 30$ mA
				15	50		$V_{IN} = 2.4V, I_{IN} = 15$ mA
I_{CC}	Quiescent Supply Current	5.5		1.1	1.5	mA	$V_{IN} = V_{CC}$ or GND, $I_{OUT} = 0$
					10		$OE_1 = OE_2 = \text{GND}$ $OE_1 = OE_2 = V_{CC}$
ΔI_{CC}	Increase in I_{CC} per Input (Note 5)	5.5		1	2.5	mA	$V_{IN} = 3.4V, I_O = 0$, one Control Input Only, Other $OE = V_{CC}$

Note 4: Measured by the voltage drop between A and B pins at the indicated current through the switch. On Resistance is determined by the lower of the voltages on the two (A or B) pins.

Note 5: Per TTL driven input ($V_{IN} = 3.4V$, control input only). A and B pins do not contribute to I_{CC} .

AC Electrical Characteristics

Symbol	Parameter	V _{CC} (V)	T _A = -40°C to +85°C, C _L = 50 pF, R _U = R _D = 500Ω			Units	Conditions	Figure Number
			Min	Typ	Max			
t _{PHL} , t _{PLH}	Propagation Delay Bus to Bus (Note 6)	4.5 to 5.5			0.25	ns	V _I = OPEN	Figures 1, 2
t _{PZL} , t _{PZH}	Output Enable Time	4.5 to 5.5	1.0	3.5	5.8	ns	V _I = 7V for t _{PZL} V _I = 0V for t _{PZH}	Figures 1, 2
t _{PLZ} , t _{PHZ}	Output Disable Time	4.5 to 5.5	0.8	3.5	4.8	ns	V _I = 7V for t _{PLZ} V _I = 0V for t _{PHZ}	Figures 1, 2

Note 6: This parameter is guaranteed. The bus switch contributes no propagation delay other than the RC delay of the typical On Resistance of the switch and the 50 pF load capacitance, when driven by an ideal voltage source (zero output impedance). The specified limit is calculated on this basis.

Capacitance

Symbol	Parameter	Typ	Max	Units	Conditions
C _{IN}	Control Pin Input Capacitance	2.5		pF	V _{CC} = 0V
C _{I/O (OFF)}	Port OFF Capacitance	6		pF	V _{CC} = 5.0V = \overline{OE}
C _{I/O (ON)}	Port ON Capacitance	12		pF	V _{CC} = 5.0V, \overline{OE} = 0V

AC Loading and Waveforms

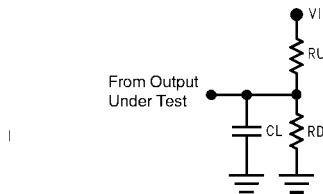

Input driven by 50Ω source terminated in 50Ω
C_L includes load and stray capacitance
Input PRR = 1.0 MHz; t_W = 500 ns

FIGURE 1. AC Test Circuit

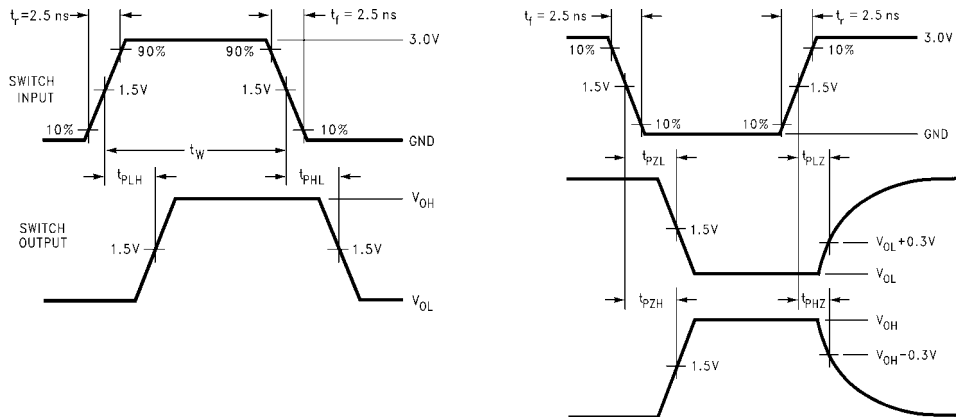

FIGURE 2. AC Waveforms

DC Characteristics

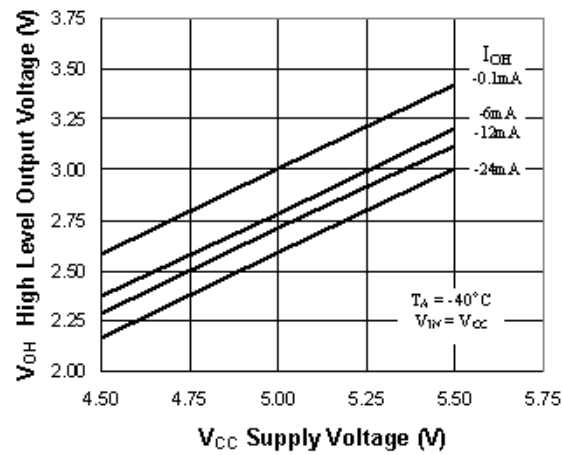
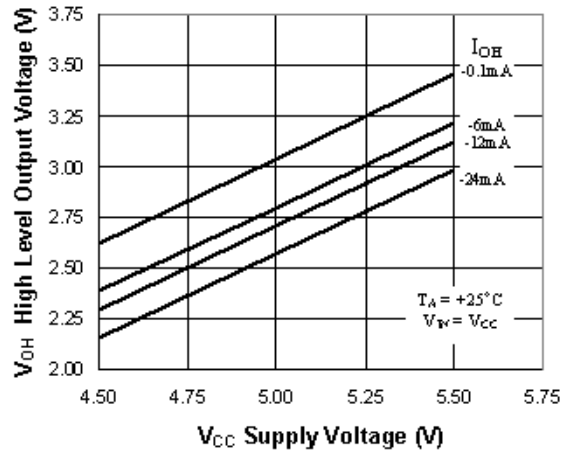
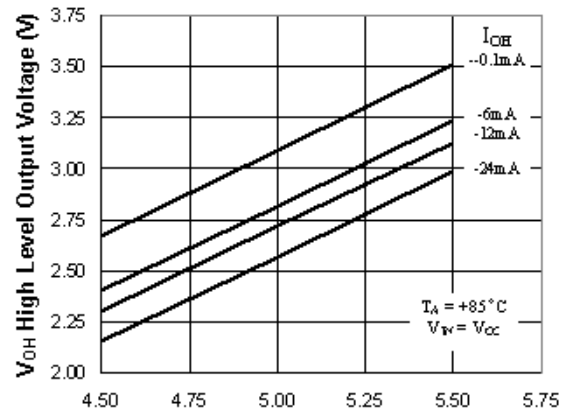

FIGURE 3. Typical High Level Output Voltage vs. Supply Voltage

NC7WBD3306

Tape and Reel Specification

TAPE FORMAT for US8

Package Designator	Tape Section	Number Cavities	Cavity Status	Cover Tape Status
K8X	Leader (Start End)	125 (typ)	Empty	Sealed
	Carrier	250	Filled	Sealed
	Trailer (Hub End)	75 (typ)	Empty	Sealed

TAPE DIMENSIONS inches (millimeters)

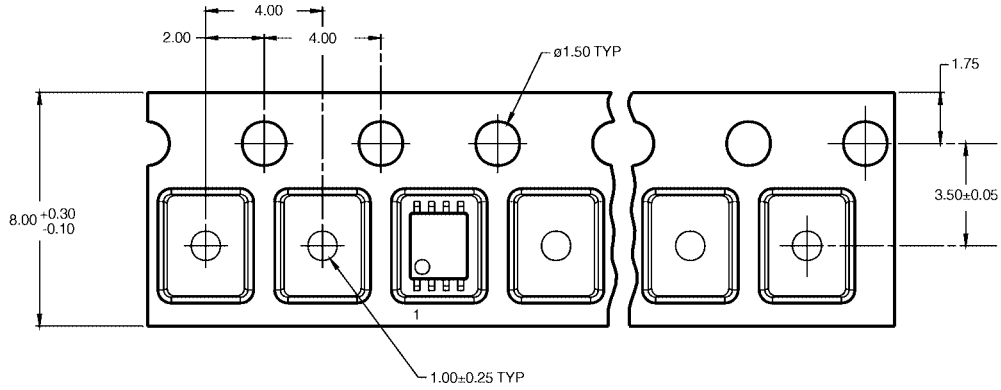

TAPE FORMAT for MicroPak

Package Designator	Tape Section	Number Cavities	Cavity Status	Cover Tape Status
L8X	Leader (Start End)	125 (typ)	Empty	Sealed
	Carrier	250	Filled	Sealed
	Trailer (Hub End)	75 (typ)	Empty	Sealed

TAPE DIMENSIONS inches (millimeters)

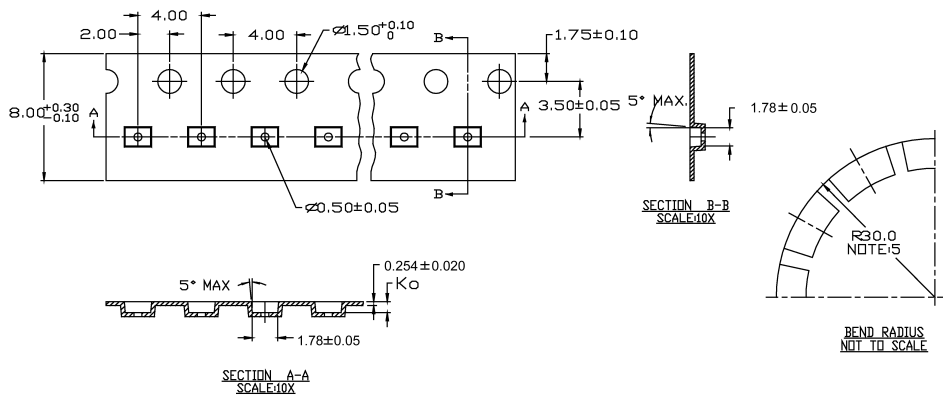

Tape and Reel Specification (Continued)

REEL DIMENSIONS inches (millimeters)

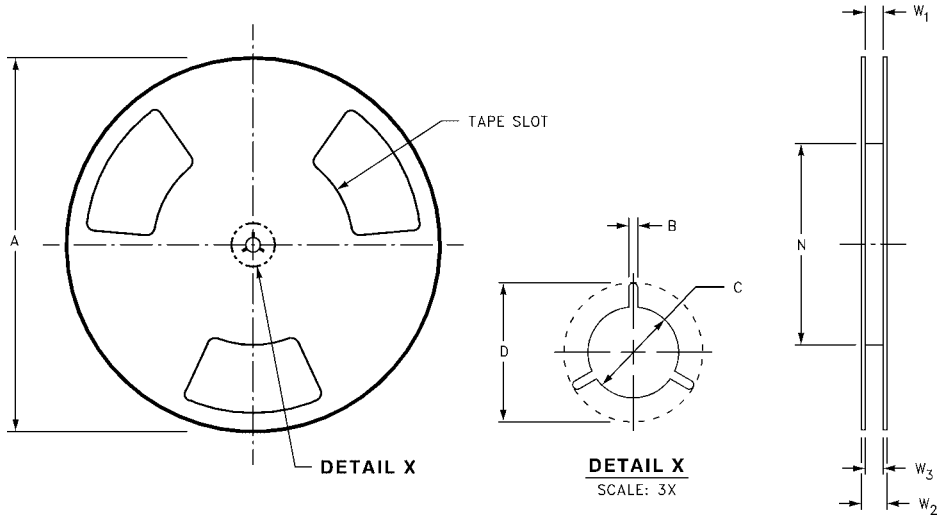

Tape Size	A	B	C	D	N	W1	W2	W3
8 mm	7.0 (177.8)	0.059 (1.50)	0.512 (13.00)	0.795 (20.20)	2.165 (55.00)	0.331 + 0.059/-0.000 (8.40 + 1.50/-0.00)	0.567 (14.40)	W1 + 0.078/-0.039 (W1 + 2.00/-1.00)

NC7WBD3306

Physical Dimensions inches (millimeters) unless otherwise noted

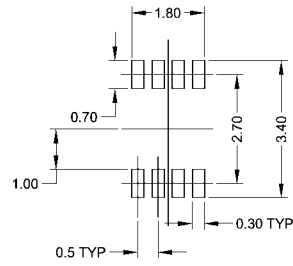
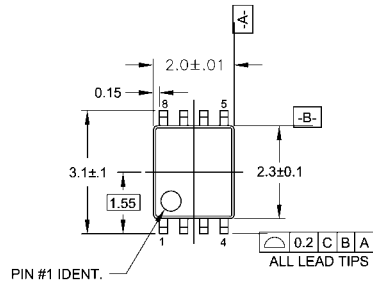

LAND PATTERN RECOMMENDATION

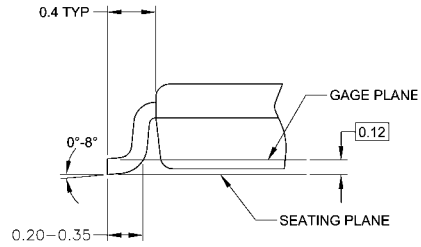
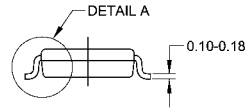
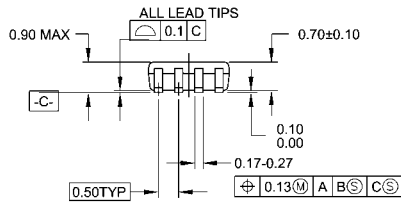

DETAIL A

NOTES:

- A. CONFORMS TO JEDEC REGISTRATION MO-187
- B. DIMENSIONS ARE IN MILLIMETERS.
- C. DIMENSIONS ARE EXCLUSIVE OF BURRS, MOLD FLASH, AND TIE BAR EXTRUSIONS.
- D. DIMENSIONS AND TOLERANCES PER ANSI Y14.5M, 1982.

MAB08AREVC

**8-Lead US8, JEDEC MO-187, Variation CA 3.1mm Wide
Package Number MAB08A**

Physical Dimensions inches (millimeters) unless otherwise noted (Continued)

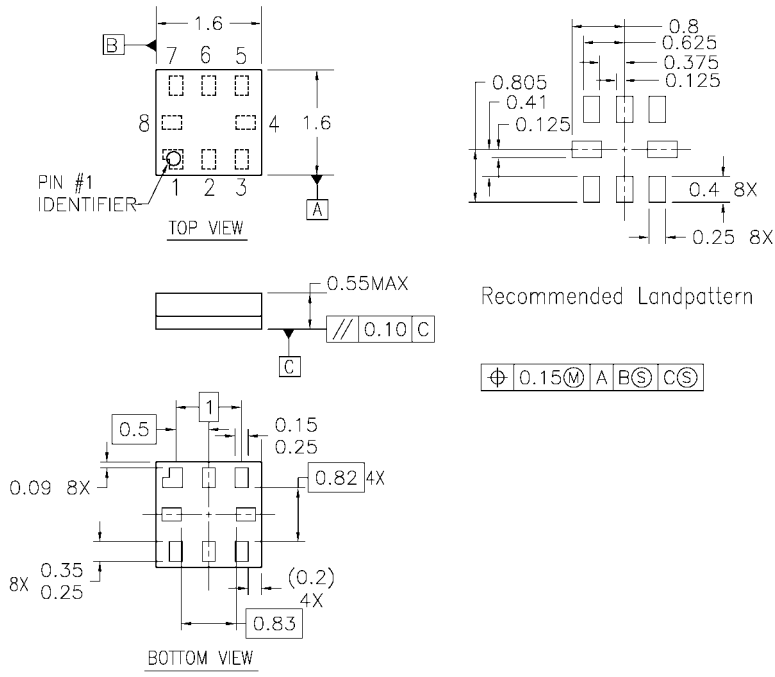

- Notes:
1. PACKAGE REGISTRATION WITH JEDEC IS ANTICIPATED
 2. DIMENSIONS ARE IN MILLIMETERS
 3. DRAWING CONFORMS TO ASME Y.14M-1994

MAC08AREVB

**8-Lead MicroPak, 1.6 mm Wide
Package Number MAC08A
(Preliminary)**

Fairchild does not assume any responsibility for use of any circuitry described, no circuit patent licenses are implied and Fairchild reserves the right at any time without notice to change said circuitry and specifications.

LIFE SUPPORT POLICY

FAIRCHILD'S PRODUCTS ARE NOT AUTHORIZED FOR USE AS CRITICAL COMPONENTS IN LIFE SUPPORT DEVICES OR SYSTEMS WITHOUT THE EXPRESS WRITTEN APPROVAL OF THE PRESIDENT OF FAIRCHILD SEMICONDUCTOR CORPORATION. As used herein:

1. Life support devices or systems are devices or systems which, (a) are intended for surgical implant into the body, or (b) support or sustain life, and (c) whose failure to perform when properly used in accordance with instructions for use provided in the labeling, can be reasonably expected to result in a significant injury to the user.
2. A critical component in any component of a life support device or system whose failure to perform can be reasonably expected to cause the failure of the life support device or system, or to affect its safety or effectiveness.

www.fairchildsemi.com