

# TinyLogic UHS Dual Buffer with Schmitt Trigger Inputs

## NC7WZ17

### Description

The NC7WZ17 is a dual buffer with Schmitt trigger inputs from onsemi's Ultra-High Speed (UHS) series of TinyLogic products. The device is fabricated with advanced CMOS technology to achieve ultra-high speed with high output drive, while maintaining low static power dissipation over a very broad  $V_{CC}$  operating range. The device is specified to operate over the 1.65 V to 5.5 V  $V_{CC}$  range. The inputs and outputs are high-impedance when  $V_{CC}$  is 0 V. Inputs tolerate voltages up to 5.5 V, independent of  $V_{CC}$  operating voltage. Schmitt trigger inputs achieve 1 V typical hysteresis between the positive- and negative-going input threshold voltage at 5 V.

### Features

- Ultra-High Speed:  $t_{PD} = 3.6$  ns (Typical) into 50 pF at 5 V  $V_{CC}$
- High Output Drive:  $\pm 24$  mA at 3 V  $V_{CC}$
- Broad  $V_{CC}$  Operating Range: 1.65 V to 5.5 V
- Matches Performance of LCX when Operated at 3.3 V  $V_{CC}$
- Power Down High-Impedance Inputs / Outputs
- Over-Voltage Tolerance Inputs Facilitate 5 V to 3 V Translation
- Proprietary Noise / EMI Reduction Circuitry
- Ultra-Small MicroPak™ Packages
- Space-Saving SC-88 Package
- These Devices are Pb-Free, Halogen Free/BFR Free and are RoHS Compliant

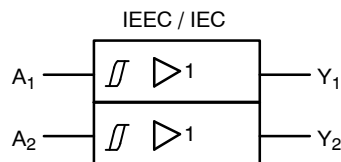
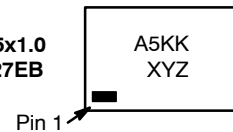

Figure 1. Logic Symbol

### MARKING DIAGRAMS



SIP6 1.45x1.0  
CASE 127EB



UDFN6  
1.0X1.0, 0.35P  
CASE 517DP

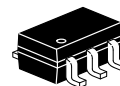
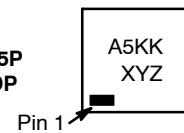

SC-88  
CASE 419B-02

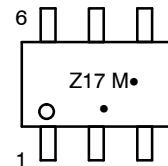

A5, Z17 = Specific Device Code  
KK = 2-Digit Lot Run Traceability Code  
XY = 2-Digit Date Code Format  
Z = Assembly Plant Code  
M = Date Code  
• = Pb-Free Package  
(Microdot may be in either location)

### ORDERING INFORMATION

See detailed ordering, marking and shipping information in the package dimensions section on page 6 of this data sheet.

NOTE: Some of the devices on this data sheet have been **DISCONTINUED**. Please refer to the table on page 6.

Pin Configurations

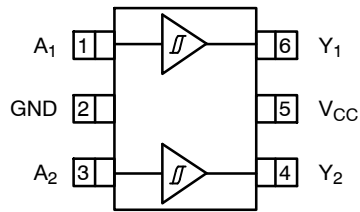

Figure 2. SC-88 (Top View)

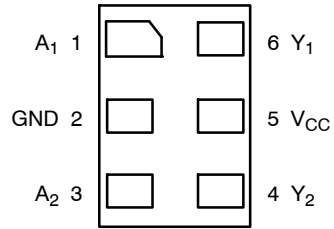
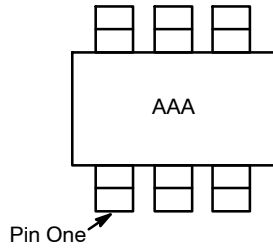

Figure 3. MicroPak (Top Through View)



NOTES:

1. AAA represents Product Code Top Mark (*see ordering code*).
2. Orientation of Top Mark determines Pin One location. Read the top product code mark left to right, Pin One is the lower left pin.

Figure 4. SC-88 Pin 1 Orientation

PIN DEFINITIONS

| Pin # SC70 | Pin # MicroPak | Name            | Description    |
|------------|----------------|-----------------|----------------|
| 1          | 1              | A <sub>1</sub>  | Input          |
| 2          | 2              | GND             | Ground         |
| 3          | 3              | A <sub>2</sub>  | Input          |
| 4          | 4              | Y <sub>2</sub>  | Output         |
| 5          | 5              | V <sub>CC</sub> | Supply Voltage |
| 6          | 6              | Y <sub>1</sub>  | Output         |

FUNCTION TABLE (Y = A)

| Inputs   | Output   |
|----------|----------|
| <b>A</b> | <b>Y</b> |
| L        | L        |
| H        | H        |

H = HIGH Logic Level  
L = LOW Logic Level

# NC7WZ17

## ABSOLUTE MAXIMUM RATINGS

| Symbol                              | Parameter   |                        | Min  | Max  | Unit |
|-------------------------------------|---|------------------------|------|------|------|
| V <sub>CC</sub>                     | Supply Voltage                                    |                        | -0.5 | 6.5  | V    |
| V <sub>IN</sub>                     | DC Input Voltage                                  |                        | -0.5 | 6.5  | V    |
| V <sub>OUT</sub>                    | DC Output Voltage                                 |                        | -0.5 | 6.5  | V    |
| I <sub>IK</sub>                     | DC Input Diode Current                            | V <sub>IN</sub> < 0 V  | -    | -50  | mA   |
| I <sub>OK</sub>                     | DC Output Diode Current                           | V <sub>OUT</sub> < 0 V | -    | -50  | mA   |
| I <sub>OUT</sub>                    | DC Output Current                                 |                        | -    | ±50  | mA   |
| I <sub>CC</sub> or I <sub>GND</sub> | DC V <sub>CC</sub> or Ground Current              |                        | -    | ±100 | mA   |
| T <sub>STG</sub>                    | Storage Temperature Range                         |                        | -65  | +150 | °C   |
| T <sub>J</sub>                      | Junction Temperature Under Bias                   |                        | -    | +150 | °C   |
| T <sub>L</sub>                      | Junction Lead Temperature (Soldering, 10 Seconds) |                        | -    | +260 | °C   |
| P <sub>D</sub>                      | Power Dissipation in Still Air                    | SC-88                  | -    | 332  | mW   |
|                                     |   | MicroPak-6             | -    | 812  |      |
|                                     |   | MicroPak2™-6           | -    | 812  |      |
| ESD                                 | Human Body Model, JEDEC: JESD22-A114              |                        | -    | 4000 | V    |
|                                     | Charge Device Model, JEDEC: JESD22-C101           |                        | -    | 2000 |      |

Stresses exceeding those listed in the Maximum Ratings table may damage the device. If any of these limits are exceeded, device functionality should not be assumed, damage may occur and reliability may be affected.

## RECOMMENDED OPERATING CONDITIONS

| Symbol           | Parameter                     | Conditions  | Min  | Max             | Unit |
|------------------|-------------------------------|-------------|------|-----------------|------|
| V <sub>CC</sub>  | Supply Voltage Operating      |             | 1.65 | 5.50            | V    |
|                  | Supply Voltage Data Retention |             | 1.50 | 5.5             |      |
| V <sub>IN</sub>  | Input Voltage                 |             | 0    | 5.5             | V    |
| V <sub>OUT</sub> | Output Voltage                |             | 0    | V <sub>CC</sub> | V    |
| T <sub>A</sub>   | Operating Temperature         |             | -40  | +85             | °C   |
| θ <sub>JA</sub>  | Thermal Resistance            | SC-88       | -    | 377             | °C/W |
|                  |                               | MicroPak-6  | -    | 154             |      |
|                  |                               | MicroPak2-6 | -    | 154             | °C/W |

Functional operation above the stresses listed in the Recommended Operating Ranges is not implied. Extended exposure to stresses beyond the Recommended Operating Ranges limits may affect device reliability.

3. Unused inputs must be held HIGH or LOW. They may not float.

## DC ELECTRICAL CHARACTERISTICS

| Symbol         | Parameter                  | V <sub>CC</sub> (V) | Conditions | T <sub>A</sub> = 25°C |      |      | T <sub>A</sub> = -40 to 85°C |      | Unit |
|----------------|----------------------------|---------------------|------------|-----------------------|------|------|------------------------------|------|------|
|                |                            |                     |            | Min                   | Typ  | Max  | Min                          | Max  |      |
| V <sub>P</sub> | Positive Threshold Voltage | 1.65                |            | -                     | 1.00 | 1.40 | -                            | 1.40 | V    |
|                |                            | 1.80                |            | -                     | 1.07 | 1.50 | -                            | 1.50 |      |
|                |                            | 2.30                |            | -                     | 1.38 | 1.80 | -                            | 1.80 |      |
|                |                            | 3.00                |            | -                     | 1.74 | 2.20 | -                            | 2.20 |      |
|                |                            | 4.50                |            | -                     | 2.43 | 3.10 | -                            | 3.10 |      |
|                |                            | 5.50                |            | -                     | 2.88 | 3.60 | -                            | 3.60 |      |

# NC7WZ17

## DC ELECTRICAL CHARACTERISTICS (continued)

| Symbol           | Parameter                  | V <sub>CC</sub> (V) | Conditions  | T <sub>A</sub> = 25°C |                              |       | T <sub>A</sub> = -40 to 85°C |      | Unit |
|------------------|----------------------------|---------------------|---|-----------------------|------------------------------|-------|------------------------------|------|------|
|                  |                            |                     |   | Min                   | Typ                          | Max   | Min                          | Max  |      |
| V <sub>N</sub>   | Negative Threshold Voltage | 1.65                |   | 0.20                  | 0.50                         | -     | 0.20                         | -    | V    |
|                  |                            | 1.80                |   | 0.25                  | 0.56                         | -     | 0.25                         | -    |      |
|                  |                            | 2.30                |   | 0.40                  | 0.75                         | -     | 0.40                         | -    |      |
|                  |                            | 3.00                |   | 0.60                  | 0.98                         | -     | 0.60                         | -    |      |
|                  |                            | 4.50                |   | 1.00                  | 1.42                         | -     | 1.00                         | -    |      |
|                  |                            | 5.50                |   | 1.20                  | 1.68                         | -     | 1.20                         | -    |      |
| V <sub>H</sub>   | Hysteresis Voltage         | 1.65                |   | 0.10                  | 0.48                         | 0.90  | 0.10                         | 0.90 | V    |
|                  |                            | 1.80                |   | 0.15                  | 0.51                         | 1.00  | 0.15                         | 1.00 |      |
|                  |                            | 2.30                |   | 0.25                  | 0.62                         | 1.10  | 0.25                         | 1.10 |      |
|                  |                            | 3.00                |   | 0.40                  | 0.76                         | 1.20  | 0.40                         | 1.20 |      |
|                  |                            | 4.50                |   | 0.60                  | 1.01                         | 1.50  | 0.60                         | 1.50 |      |
|                  |                            | 5.50                |   | 0.70                  | 1.20                         | 1.70  | 0.70                         | 1.70 |      |
| V <sub>OH</sub>  | HIGH Level Output Voltage  | 1.65                | V <sub>IN</sub> = V <sub>P</sub> or V <sub>N</sub> ,<br>I <sub>OH</sub> = -100 μA | 1.55                  | 1.65                         | -     | 1.55                         | -    | V    |
|                  |                            | 1.80                |   | 1.70                  | 1.80                         | -     | 1.70                         | -    |      |
|                  |                            | 2.30                |   | 2.20                  | 2.30                         | -     | 2.20                         | -    |      |
|                  |                            | 3.00                |   | 2.90                  | 3.00                         | -     | 2.90                         | -    |      |
|                  |                            | 4.50                |   | 4.40                  | 4.50                         | -     | 4.40                         | -    |      |
|                  |                            | 1.65                | I <sub>OH</sub> = -4 mA   | 1.29                  | 1.52                         | -     | 1.29                         | -    |      |
|                  |                            | 2.30                | I <sub>OH</sub> = -8 mA   | 1.90                  | 2.14                         | -     | 1.90                         | -    |      |
|                  |                            | 3.00                | I <sub>OH</sub> = -16 mA  | 2.40                  | 2.75                         | -     | 2.40                         | -    |      |
|                  |                            | 3.00                | I <sub>OH</sub> = -24 mA  | 2.30                  | 2.62                         | -     | 2.30                         | -    |      |
|                  |                            | 4.50                | I <sub>OH</sub> = -32 mA  | 3.80                  | 4.13                         | -     | 3.80                         | -    |      |
| V <sub>OL</sub>  | LOW Level Output Voltage   | 1.65                | V <sub>IN</sub> = V <sub>P</sub> or V <sub>N</sub> ,<br>I <sub>OL</sub> = 100 μA  | -                     | 0.00                         | 0.10  | -                            | 0.10 | V    |
|                  |                            | 1.80                |   | -                     | 0.00                         | 0.10  | -                            | 0.10 |      |
|                  |                            | 2.30                |   | -                     | 0.00                         | 0.10  | -                            | 0.10 |      |
|                  |                            | 3.00                |   | -                     | 0.00                         | 0.10  | -                            | 0.10 |      |
|                  |                            | 4.50                |   | -                     | 0.00                         | 0.10  | -                            | 0.10 |      |
|                  |                            | 1.65                | I <sub>OL</sub> = 4 mA  | -                     | 0.08                         | 0.24  | -                            | 0.24 |      |
|                  |                            | 2.30                | I <sub>OL</sub> = 8 mA  | -                     | 0.10                         | 0.30  | -                            | 0.30 |      |
|                  |                            | 3.00                | I <sub>OL</sub> = 16 mA   | -                     | 0.16                         | 0.40  | -                            | 0.40 |      |
|                  |                            | 3.00                | I <sub>OL</sub> = 24 mA   | -                     | 0.24                         | 0.55  | -                            | 0.55 |      |
|                  |                            | 4.50                | I <sub>OL</sub> = 32 mA   | -                     | 0.25                         | 0.550 | -                            | 0.55 |      |
|                  |                            | I <sub>IN</sub>     | Input Leakage Current   | 1.65 to 5.5           | V <sub>IN</sub> = 5.5 V, GND | -     | -                            | ±0.1 |      |
| I <sub>OFF</sub> | Power Off Leakage Current  | 0                   | V <sub>IN</sub> or V <sub>OUT</sub> = 5.5 V                                       | -                     | -                            | 1     | -                            | 10   | μA   |
| I <sub>CC</sub>  | Quiescent Supply Current   | 1.65 to 5.50        | V <sub>IN</sub> = 5.5 V, GND  | -                     | -                            | 1     | -                            | 10   | μA   |

AC ELECTRICAL CHARACTERISTICS

| Symbol                              | Parameter  | V <sub>CC</sub> (V) | Conditions                                       | T <sub>A</sub> = 25°C                             |      |      | T <sub>A</sub> = -40 to 85°C |      | Unit |
|-------------------------------------|--|---------------------|--|---|------|------|------------------------------|------|------|
|                                     |  |                     |  | Min   | Typ  | Max  | Min                          | Max  |      |
| t <sub>PLH</sub> , t <sub>PHL</sub> | Propagation Delay<br>(Figure 5, 6)                   | 1.65                | C <sub>L</sub> = 15 pF,<br>R <sub>L</sub> = 1 MΩ | -   | 8.3  | 14.3 | -                            | 15.8 | ns   |
|                                     |  | 1.80                |  | -   | 6.9  | 11.9 | -                            | 13.1 |      |
|                                     |  | 2.50 ±0.20          |  | -   | 4.8  | 8.2  | -                            | 9.0  |      |
|                                     |  | 3.30 ±0.30          |  | -   | 3.7  | 5.6  | -                            | 6.2  |      |
|                                     |  | 5.00 ±0.50          |  | -   | 3.0  | 4.7  | -                            | 5.2  |      |
|                                     |  | 3.30 ±0.30          |  | C <sub>L</sub> = 50 pF,<br>R <sub>L</sub> = 500 Ω | -    | 4.3  | 6.6                          | -    |      |
|                                     |  | 5.00 ±0.50          | -  |   | 3.6  | 5.6  | -                            | 6.2  |      |
| C <sub>IN</sub>                     | Input Capacitance                                    | 0                   |  | -   | 2.5  | -    | -                            | -    | pF   |
| C <sub>PD</sub>                     | Power Dissipation Capacitance<br>(Note 4) (Figure 7) | 3.30                |  | -   | 10.0 | -    | -                            | -    | pF   |
|                                     |  | 5.00                |  | -   | 12.0 | -    | -                            | -    |      |

4. C<sub>PD</sub> is defined as the value of the internal equivalent capacitance which is derived from dynamic operating current consumption (I<sub>CCD</sub>) at no output loading and operating at 50% duty cycle. C<sub>PD</sub> is related to I<sub>CCD</sub> dynamic operating current by the expression:  
 $I_{CCD} = (C_{PD}) (V_{CC}) (f_{IN}) + (I_{CCstatic})$ .

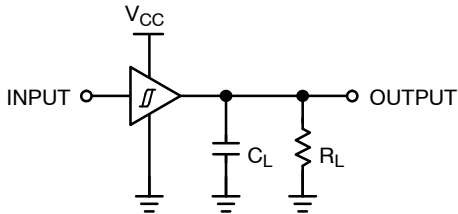

NOTE:  
 5. C<sub>L</sub> includes load and stray capacitance;  
 Input PRR = 1.0 MHz, t<sub>W</sub> = 500 ns

Figure 5. AC Test Circuit

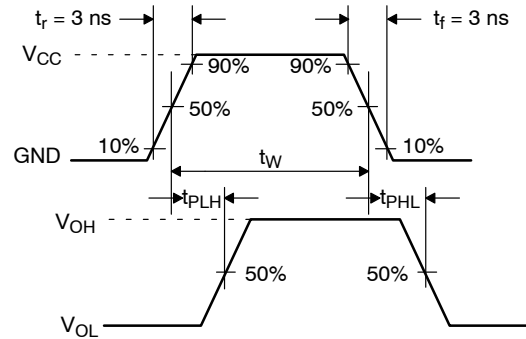
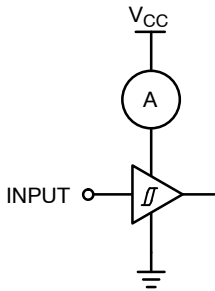

Figure 6. AC Waveforms



NOTE:  
 6. Input = AC Waveform; t<sub>r</sub> = t<sub>f</sub> = 1.8 ns;  
 PRR = 10 MHz; Duty Cycle = 50%.

Figure 7. I<sub>CCD</sub> Test Circuit

# NC7WZ17

## DEVICE ORDERING INFORMATION

| Device     | Top Mark | Packages                                     | Shipping <sup>†</sup> |
|------------|----------|--|-----------------------|
| NC7WZ17P6X | Z17      | 6-Lead SC70, EIAJ SC-88, 1.25 mm Wide        | 3000 / Tape & Reel    |
| NC7WZ17L6X | A5       | 6-Lead MicroPak, 1.00 mm Wide                | 5000 / Tape & Reel    |
| NC7WZ17FHX | A5       | 6-Lead, MicroPak2, 1x1 mm Body, .35 mm Pitch | 5000 / Tape & Reel    |

### DISCONTINUED (Note 7)

|                   |     |  |                    |
|-------------------|-----|--|--------------------|
| NC7WZ17P6X-L22347 | Z17 | 6-Lead SC70, EIAJ SC-88, 1.25 mm Wide        | 3000 / Tape & Reel |
| NC7WZ17L6X-L22175 | A5  | 6-Lead MicroPak, 1.00 mm Wide                | 5000 / Tape & Reel |
| NC7WZ17FHX-L22175 | A5  | 6-Lead, MicroPak2, 1x1 mm Body, .35 mm Pitch | 5000 / Tape & Reel |

<sup>†</sup>For information on tape and reel specifications, including part orientation and tape sizes, please refer to our Tape and Reel Packaging Specifications Brochure, BRD8011/D.

7. **DISCONTINUED:** These devices are not recommended for new design. Please contact your **onsemi** representative for information. The most current information on these devices may be available on [www.onsemi.com](http://www.onsemi.com).

# MECHANICAL CASE OUTLINE

## PACKAGE DIMENSIONS

ON Semiconductor®



SIP6 1.45X1.0  
CASE 127EB  
ISSUE O

DATE 31 AUG 2016



**NOTES:**

1. CONFORMS TO JEDEC STANDARD MO-252 VARIATION UAAD
2. DIMENSIONS ARE IN MILLIMETERS
3. DRAWING CONFORMS TO ASME Y14.5M-2009
4. PIN ONE IDENTIFIER IS 2X LENGTH OF ANY OTHER LINE IN THE MARK CODE LAYOUT.

|                         |                      |  |
|-------------------------|----------------------|--|
| <b>DOCUMENT NUMBER:</b> | <b>98AON13590G</b>   | Electronic versions are uncontrolled except when accessed directly from the Document Repository. Printed versions are uncontrolled except when stamped "CONTROLLED COPY" in red. |
| <b>DESCRIPTION:</b>     | <b>SIP6 1.45X1.0</b> | <b>PAGE 1 OF 1</b>   |

ON Semiconductor and are trademarks of Semiconductor Components Industries, LLC dba ON Semiconductor or its subsidiaries in the United States and/or other countries. ON Semiconductor reserves the right to make changes without further notice to any products herein. ON Semiconductor makes no warranty, representation or guarantee regarding the suitability of its products for any particular purpose, nor does ON Semiconductor assume any liability arising out of the application or use of any product or circuit, and specifically disclaims any and all liability, including without limitation special, consequential or incidental damages. ON Semiconductor does not convey any license under its patent rights nor the rights of others.

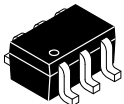

1

**SC-88 (SC-70 6 Lead), 1.25x2**  
**CASE 419AD**  
**ISSUE A**

DATE 07 JUL 2010

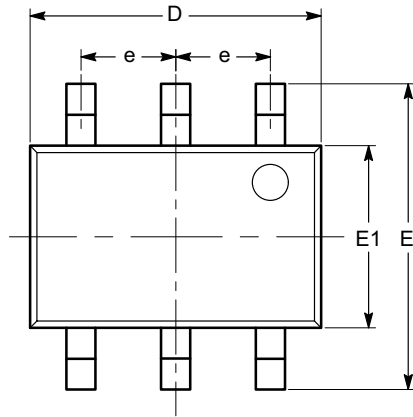

TOP VIEW

| SYMBOL     | MIN      | NOM  | MAX  |
|------------|----------|------|------|
| A          | 0.80     |      | 1.10 |
| A1         | 0.00     |      | 0.10 |
| A2         | 0.80     |      | 1.00 |
| b          | 0.15     |      | 0.30 |
| c          | 0.10     |      | 0.18 |
| D          | 1.80     | 2.00 | 2.20 |
| E          | 1.80     | 2.10 | 2.40 |
| E1         | 1.15     | 1.25 | 1.35 |
| e          | 0.65 BSC |      |      |
| L          | 0.26     | 0.36 | 0.46 |
| L1         | 0.42 REF |      |      |
| L2         | 0.15 BSC |      |      |
| $\theta$   | 0°       |      | 8°   |
| $\theta_1$ | 4°       |      | 10°  |

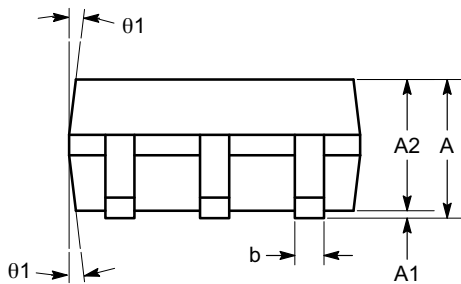

SIDE VIEW

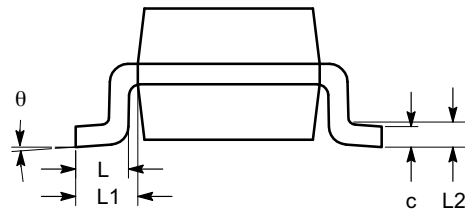

END VIEW

**Notes:**

- (1) All dimensions are in millimeters. Angles in degrees.
- (2) Complies with JEDEC MO-203.

|                         |                                     |  |
|-------------------------|-------------------------------------|--|
| <b>DOCUMENT NUMBER:</b> | <b>98AON34266E</b>                  | Electronic versions are uncontrolled except when accessed directly from the Document Repository. Printed versions are uncontrolled except when stamped "CONTROLLED COPY" in red. |
| <b>DESCRIPTION:</b>     | <b>SC-88 (SC-70 6 LEAD), 1.25X2</b> | <b>PAGE 1 OF 1</b>   |

onsemi and Onsemi are trademarks of Semiconductor Components Industries, LLC dba onsemi or its subsidiaries in the United States and/or other countries. onsemi reserves the right to make changes without further notice to any products herein. onsemi makes no warranty, representation or guarantee regarding the suitability of its products for any particular purpose, nor does onsemi assume any liability arising out of the application or use of any product or circuit, and specifically disclaims any and all liability, including without limitation special, consequential or incidental damages. onsemi does not convey any license under its patent rights nor the rights of others.





SC-88 2.00x1.25x0.90, 0.65P  
CASE 419B-02  
ISSUE Z

DATE 18 APR 2024

NOTES:

1. DIMENSIONING AND TOLERANCING CONFORM TO ASME Y14.5-2018.
2. ALL DIMENSION ARE IN MILLIMETERS.
3. DIMENSIONS D AND E1 DO NOT INCLUDE MOLD FLASH, PROTRUSIONS, OR GATE BURRS. MOLD FLASH, PROTRUSIONS, OR GATE BURRS SHALL NOT EXCEED 0.20 PER END.
4. DIMENSIONS D AND E1 AT THE OUTERMOST EXTREMES OF THE PLASTIC BODY AND DATUM H.
5. DATUMS A AND B ARE DETERMINED AT DATUM H.
6. DIMENSIONS b AND c APPLY TO THE FLAT SECTION OF THE LEAD BETWEEN 0.08 AND 0.15 FROM THE TIP.
7. DIMENSION b DOES NOT INCLUDE DAMBAR PROTRUSION. ALLOWABLE DAMBAR PROTRUSION SHALL BE 0.08 TOTAL IN EXCESS OF DIMENSION b AT MAXIMUM MATERIAL CONDITION. THE DAMBAR CANNOT BE LOCATED ON THE LOWER RADIUS OF THE FOOT.

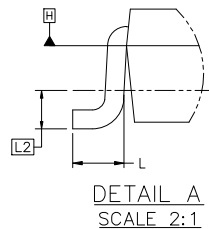
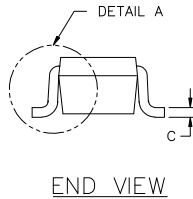
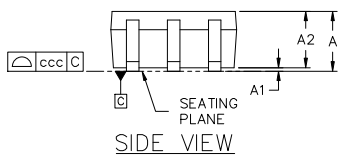
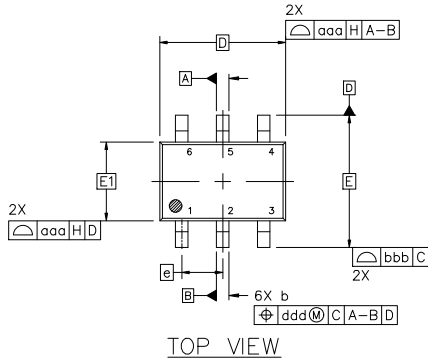

| DIM | MILLIMETERS |      |      |
|-----|-------------|------|------|
|     | MIN.        | NOM. | MAX. |
| A   | ---         | ---  | 1.10 |
| A1  | 0.00        | ---  | 0.10 |
| A2  | 0.70        | 0.90 | 1.00 |
| b   | 0.15        | 0.20 | 0.25 |
| c   | 0.08        | 0.15 | 0.22 |
| D   | 2.00 BSC    |      |      |
| E   | 2.10 BSC    |      |      |
| E1  | 1.25 BSC    |      |      |
| e   | 0.65 BSC    |      |      |
| L   | 0.26        | 0.36 | 0.46 |
| L2  | 0.15 BSC    |      |      |
| aaa | 0.15        |      |      |
| bbb | 0.30        |      |      |
| ccc | 0.10        |      |      |
| ddd | 0.10        |      |      |

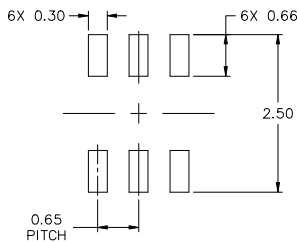

\* FOR ADDITIONAL INFORMATION ON OUR Pb-FREE STRATEGY AND SOLDERING DETAILS, PLEASE DOWNLOAD THE ONSEMI SOLDERING AND MOUNTING TECHNIQUES REFERENCE MANUAL, SOLDERRM/D.

GENERIC MARKING DIAGRAM\*

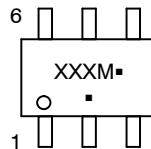

XXX = Specific Device Code  
M = Date Code\*  
▪ = Pb-Free Package

(Note: Microdot may be in either location)

\*Date Code orientation and/or position may vary depending upon manufacturing location.

\*This information is generic. Please refer to device data sheet for actual part marking. Pb-Free indicator, "G" or microdot "▪", may or may not be present. Some products may not follow the Generic Marking.

STYLES ON PAGE 2

|                  |                             |  |
|------------------|-----------------------------|--|
| DOCUMENT NUMBER: | 98ASB42985B                 | Electronic versions are uncontrolled except when accessed directly from the Document Repository. Printed versions are uncontrolled except when stamped "CONTROLLED COPY" in red. |
| DESCRIPTION:     | SC-88 2.00x1.25x0.90, 0.65P | PAGE 1 OF 2  |

onsemi and ONSEMI are trademarks of Semiconductor Components Industries, LLC dba onsemi or its subsidiaries in the United States and/or other countries. onsemi reserves the right to make changes without further notice to any products herein. onsemi makes no warranty, representation or guarantee regarding the suitability of its products for any particular purpose, nor does onsemi assume any liability arising out of the application or use of any product or circuit, and specifically disclaims any and all liability, including without limitation special, consequential or incidental damages. onsemi does not convey any license under its patent rights nor the rights of others.

**SC-88 2.00x1.25x0.90, 0.65P**  
**CASE 419B-02**  
**ISSUE Z**

DATE 18 APR 2024

|  |  |   |   |   |   |
|--|--|---|---|---|---|
| STYLE 1:<br>PIN 1. EMITTER 2<br>2. BASE 2<br>3. COLLECTOR 1<br>4. EMITTER 1<br>5. BASE 1<br>6. COLLECTOR 2 | STYLE 2:<br>CANCELLED  | STYLE 3:<br>CANCELLED   | STYLE 4:<br>PIN 1. CATHODE<br>2. CATHODE<br>3. COLLECTOR<br>4. EMITTER<br>5. BASE<br>6. ANODE               | STYLE 5:<br>PIN 1. ANODE<br>2. ANODE<br>3. COLLECTOR<br>4. EMITTER<br>5. BASE<br>6. CATHODE                 | STYLE 6:<br>PIN 1. ANODE 2<br>2. N/C<br>3. CATHODE 1<br>4. ANODE 1<br>5. N/C<br>6. CATHODE 2          |
| STYLE 7:<br>PIN 1. SOURCE 2<br>2. DRAIN 2<br>3. GATE 1<br>4. SOURCE 1<br>5. DRAIN 1<br>6. GATE 2           | STYLE 8:<br>CANCELLED  | STYLE 9:<br>PIN 1. EMITTER 2<br>2. EMITTER 1<br>3. COLLECTOR 1<br>4. BASE 1<br>5. BASE 2<br>6. COLLECTOR 2  | STYLE 10:<br>PIN 1. SOURCE 2<br>2. SOURCE 1<br>3. GATE 1<br>4. DRAIN 1<br>5. DRAIN 2<br>6. GATE 2           | STYLE 11:<br>PIN 1. CATHODE 2<br>2. CATHODE 2<br>3. ANODE 1<br>4. CATHODE 1<br>5. CATHODE 1<br>6. ANODE 2   | STYLE 12:<br>PIN 1. ANODE 2<br>2. ANODE 2<br>3. CATHODE 1<br>4. ANODE 1<br>5. ANODE 1<br>6. CATHODE 2 |
| STYLE 13:<br>PIN 1. ANODE<br>2. N/C<br>3. COLLECTOR<br>4. EMITTER<br>5. BASE<br>6. CATHODE                 | STYLE 14:<br>PIN 1. VREF<br>2. GND<br>3. GND<br>4. IOUT<br>5. VEN<br>6. VCC                            | STYLE 15:<br>PIN 1. ANODE 1<br>2. ANODE 2<br>3. ANODE 3<br>4. CATHODE 3<br>5. CATHODE 2<br>6. CATHODE 1     | STYLE 16:<br>PIN 1. BASE 1<br>2. EMITTER 2<br>3. COLLECTOR 2<br>4. BASE 2<br>5. EMITTER 1<br>6. COLLECTOR 1 | STYLE 17:<br>PIN 1. BASE 1<br>2. EMITTER 1<br>3. COLLECTOR 2<br>4. BASE 2<br>5. EMITTER 2<br>6. COLLECTOR 1 | STYLE 18:<br>PIN 1. VIN1<br>2. VCC<br>3. VOUT2<br>4. VIN2<br>5. GND<br>6. VOUT1                       |
| STYLE 19:<br>PIN 1. IOUT<br>2. GND<br>3. GND<br>4. V CC<br>5. V EN<br>6. V REF                             | STYLE 20:<br>PIN 1. COLLECTOR<br>2. COLLECTOR<br>3. BASE<br>4. EMITTER<br>5. COLLECTOR<br>6. COLLECTOR | STYLE 21:<br>PIN 1. ANODE 1<br>2. N/C<br>3. ANODE 2<br>4. CATHODE 2<br>5. N/C<br>6. CATHODE 1               | STYLE 22:<br>PIN 1. D1 (i)<br>2. GND<br>3. D2 (i)<br>4. D2 (c)<br>5. VBUS<br>6. D1 (c)                      | STYLE 23:<br>PIN 1. Vn<br>2. CH1<br>3. Vp<br>4. N/C<br>5. CH2<br>6. N/C                                     | STYLE 24:<br>PIN 1. CATHODE<br>2. ANODE<br>3. CATHODE<br>4. CATHODE<br>5. CATHODE<br>6. CATHODE       |
| STYLE 25:<br>PIN 1. BASE 1<br>2. CATHODE<br>3. COLLECTOR 2<br>4. BASE 2<br>5. EMITTER<br>6. COLLECTOR 1    | STYLE 26:<br>PIN 1. SOURCE 1<br>2. GATE 1<br>3. DRAIN 2<br>4. SOURCE 2<br>5. GATE 2<br>6. DRAIN 1      | STYLE 27:<br>PIN 1. BASE 2<br>2. BASE 1<br>3. COLLECTOR 1<br>4. EMITTER 1<br>5. EMITTER 2<br>6. COLLECTOR 2 | STYLE 28:<br>PIN 1. DRAIN<br>2. DRAIN<br>3. GATE<br>4. SOURCE<br>5. DRAIN<br>6. DRAIN                       | STYLE 29:<br>PIN 1. ANODE<br>2. ANODE<br>3. COLLECTOR<br>4. EMITTER<br>5. BASE/ANODE<br>6. CATHODE          | STYLE 30:<br>PIN 1. SOURCE 1<br>2. DRAIN 2<br>3. DRAIN 2<br>4. SOURCE 2<br>5. GATE 1<br>6. DRAIN 1    |

Note: Please refer to datasheet for style callout. If style type is not called out in the datasheet refer to the device datasheet pinout or pin assignment.

|                         |                                    |   |
|-------------------------|------------------------------------|---|
| <b>DOCUMENT NUMBER:</b> | <b>98ASB42985B</b>                 | Electronic versions are uncontrolled except when accessed directly from the Document Repository.<br>Printed versions are uncontrolled except when stamped "CONTROLLED COPY" in red. |
| <b>DESCRIPTION:</b>     | <b>SC-88 2.00x1.25x0.90, 0.65P</b> | <b>PAGE 2 OF 2</b>  |

**onsemi** and **ONSEMI** are trademarks of Semiconductor Components Industries, LLC dba **onsemi** or its subsidiaries in the United States and/or other countries. **onsemi** reserves the right to make changes without further notice to any products herein. **onsemi** makes no warranty, representation or guarantee regarding the suitability of its products for any particular purpose, nor does **onsemi** assume any liability arising out of the application or use of any product or circuit, and specifically disclaims any and all liability, including without limitation special, consequential or incidental damages. **onsemi** does not convey any license under its patent rights nor the rights of others.



**UDFN6 1.0X1.0, 0.35P**  
CASE 517DP  
ISSUE O

DATE 31 AUG 2016

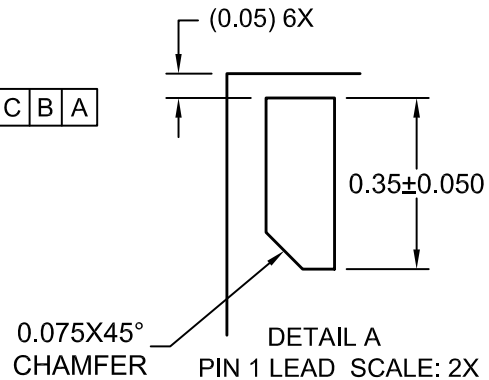
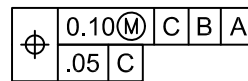
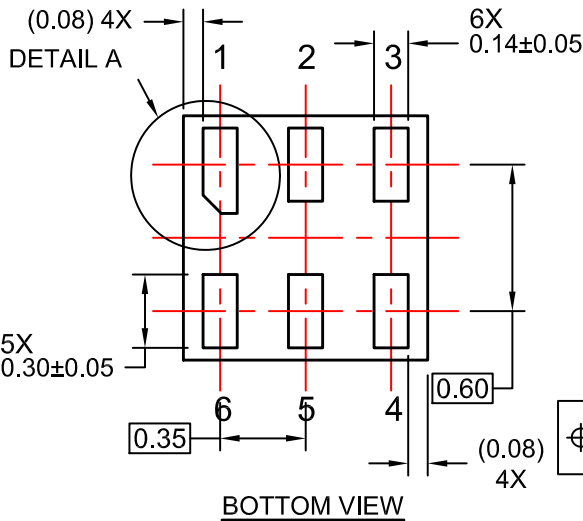
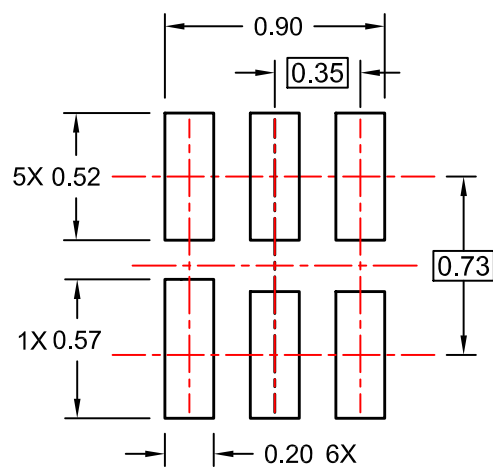
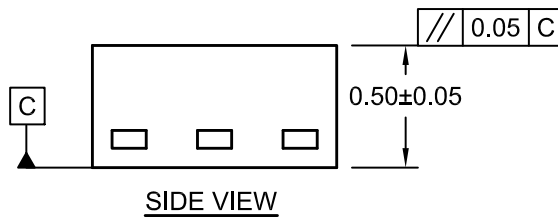
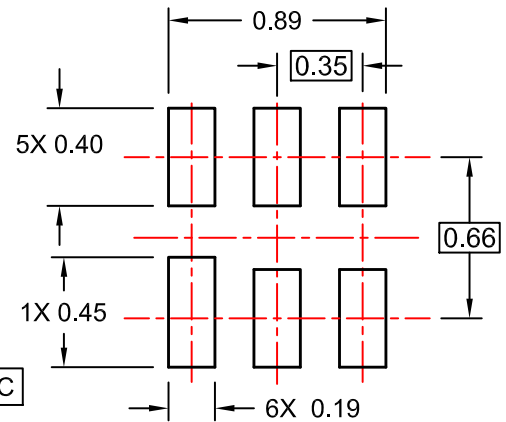
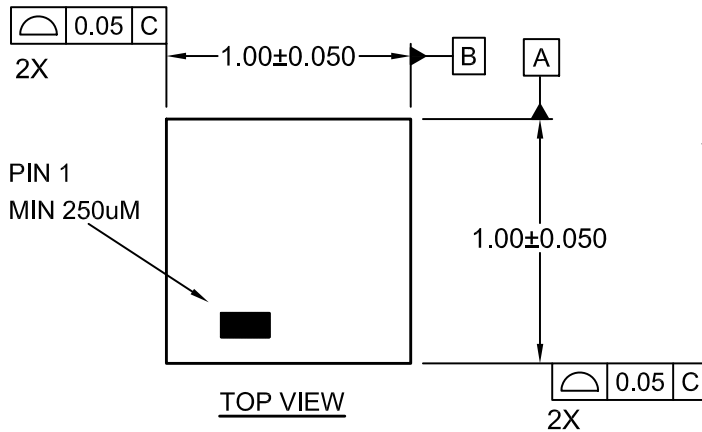

- NOTES:  
A. COMPLIES TO JEDEC MO-252 STANDARD  
B. DIMENSIONS ARE IN MILLIMETERS.  
C. DIMENSIONS AND TOLERANCES PER ASME Y14.5M, 2009

|                         |                             |  |
|-------------------------|-----------------------------|--|
| <b>DOCUMENT NUMBER:</b> | <b>98AON13593G</b>          | Electronic versions are uncontrolled except when accessed directly from the Document Repository. Printed versions are uncontrolled except when stamped "CONTROLLED COPY" in red. |
| <b>DESCRIPTION:</b>     | <b>UDFN6 1.0X1.0, 0.35P</b> | <b>PAGE 1 OF 1</b>   |

ON Semiconductor and are trademarks of Semiconductor Components Industries, LLC dba ON Semiconductor or its subsidiaries in the United States and/or other countries. ON Semiconductor reserves the right to make changes without further notice to any products herein. ON Semiconductor makes no warranty, representation or guarantee regarding the suitability of its products for any particular purpose, nor does ON Semiconductor assume any liability arising out of the application or use of any product or circuit, and specifically disclaims any and all liability, including without limitation special, consequential or incidental damages. ON Semiconductor does not convey any license under its patent rights nor the rights of others.

**onsemi**, **Onsemi**, and other names, marks, and brands are registered and/or common law trademarks of Semiconductor Components Industries, LLC dba "**onsemi**" or its affiliates and/or subsidiaries in the United States and/or other countries. **onsemi** owns the rights to a number of patents, trademarks, copyrights, trade secrets, and other intellectual property. A listing of **onsemi**'s product/patent coverage may be accessed at [www.onsemi.com/site/pdf/Patent-Marking.pdf](http://www.onsemi.com/site/pdf/Patent-Marking.pdf). **onsemi** reserves the right to make changes at any time to any products or information herein, without notice. The information herein is provided "as-is" and **onsemi** makes no warranty, representation or guarantee regarding the accuracy of the information, product features, availability, functionality, or suitability of its products for any particular purpose, nor does **onsemi** assume any liability arising out of the application or use of any product or circuit, and specifically disclaims any and all liability, including without limitation special, consequential or incidental damages. Buyer is responsible for its products and applications using **onsemi** products, including compliance with all laws, regulations and safety requirements or standards, regardless of any support or applications information provided by **onsemi**. "Typical" parameters which may be provided in **onsemi** data sheets and/or specifications can and do vary in different applications and actual performance may vary over time. All operating parameters, including "Typicals" must be validated for each customer application by customer's technical experts. **onsemi** does not convey any license under any of its intellectual property rights nor the rights of others. **onsemi** products are not designed, intended, or authorized for use as a critical component in life support systems or any FDA Class 3 medical devices or medical devices with a same or similar classification in a foreign jurisdiction or any devices intended for implantation in the human body. Should Buyer purchase or use **onsemi** products for any such unintended or unauthorized application, Buyer shall indemnify and hold **onsemi** and its officers, employees, subsidiaries, affiliates, and distributors harmless against all claims, costs, damages, and expenses, and reasonable attorney fees arising out of, directly or indirectly, any claim of personal injury or death associated with such unintended or unauthorized use, even if such claim alleges that **onsemi** was negligent regarding the design or manufacture of the part. **onsemi** is an Equal Opportunity/Affirmative Action Employer. This literature is subject to all applicable copyright laws and is not for resale in any manner.

## ADDITIONAL INFORMATION

### TECHNICAL PUBLICATIONS:

Technical Library: [www.onsemi.com/design/resources/technical-documentation](http://www.onsemi.com/design/resources/technical-documentation)  
onsemi Website: [www.onsemi.com](http://www.onsemi.com)

### ONLINE SUPPORT: [www.onsemi.com/support](http://www.onsemi.com/support)

For additional information, please contact your local Sales Representative at [www.onsemi.com/support/sales](http://www.onsemi.com/support/sales)