

# DATA SHEET

## TFT LCD Monitor Control Board

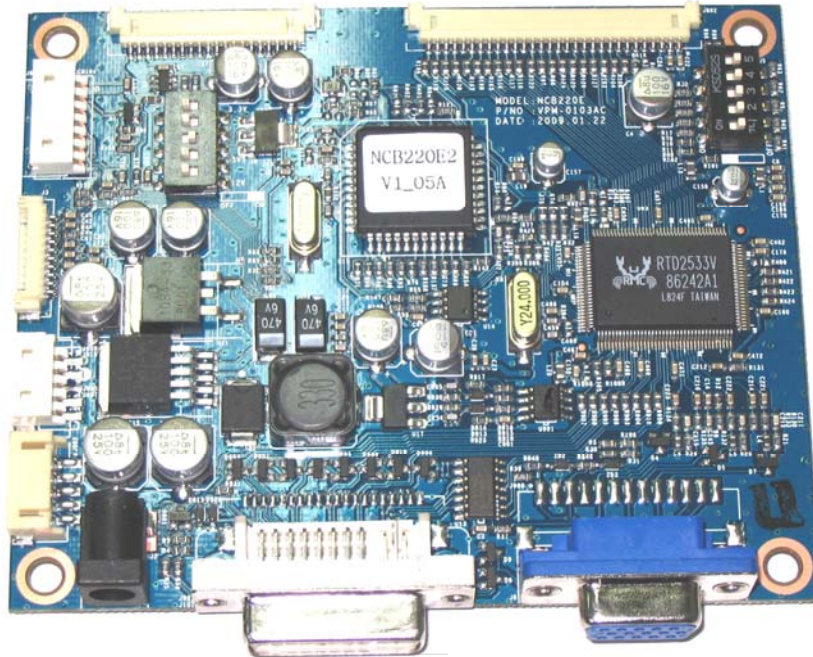

<b>NCB220E</b>	
<b>NCB220E1</b>	Analog input support Max resolution : WSXGA+
<b>NCB220E2</b>	Analog & DVI input support Max resolution : WSXGA+
<b>NCB220E1/E2 (SMD type)</b>	Analog / Analog & DVI input support Max resolution : WSXGA+ Low profile component

**RoHS** Compliant

January 2009

**CONTENT**

<b>COVER</b>	<b>1</b>
<b>CONTENT</b>	<b>2</b>
<b>Record of revision</b>	<b>3</b>
<b>1 INTRODUCTION</b>	<b>4</b>
<b>2 GENERAL SPECIFICATION</b>	<b>5</b>
<b>3 ELECTRICAL SPECIFICATION</b>	<b>6</b>
<b>4 BLOCK DIAGRAM</b>	<b>7</b>
<b>5 CONNCTION CABLE</b>	<b>8</b>
<b>6 ASSEMBLY NOTES</b>	<b>9</b>
<b>7 OSD MENU</b>	<b>11</b>
<b>8 CONNECTION &amp; OPERATION</b>	<b>16</b>
<b>9 CONNECTOR, PINOUT &amp; JUMPERS</b>	<b>17</b>
<b>10 CONTROLLER DIMENSIONS</b>	<b>27</b>
<b>11 APPLICATION NOTES</b>	<b>28</b>
<b>12 TROUBLESHOOTING</b>	<b>29</b>
<b>13 ACCESSORY</b>	<b>30</b>

**RECORD OF REVISION**

No	Description	Revision	Page	Date
1	E/S	A1		
2	MP	AA		2007-05-23
3	Correction of mistyping	AA	18	2007-06-20
4	Added F/W for Special Panel setting	AB	27	2008-07-25
5	PCB Revision ( Changed J905/907 3P → 5P )	AC	19	2009-01-22

## 1. INTRODUCTION

Designed for LCD monitor and other flat panel display application, the NCB220E controller provides an auto input synchronization and easy to use interface controller for:

- ▶ TFT (active matrix) LCD panels of 640x480 to 1280x1024 & 1440 x 900, 1680x1050 resolutions.
- ▶ Computer video signals of VGA, SVGA, XGA, WXGA+, SXGA, WSXGA+ standard.
- ▶ Input Signal Support
  - All VESA standard

### HOW TO PROCEED

- ▶ Ensure that you have all parts & they are correct, referring to:
  - Connection diagram
  - Connector reference
  - Assembly notes
- ▶ Check controller switch & jumper settings (errors may damage the panel)
- ▶ Prepare the PC
- ▶ Connect the parts
- ▶ Understand the operation & functions

### IMPORTANT USAGE NOTE

This equipment is for use by developers and integrators. The manufacturer accepts no liability for damage or injury caused by the use of this product. It is the responsibility of the developer, integrators or other users of this product to:

- Ensure that all necessary and appropriate safety measures are taken.
- Obtain suitable regulatory approvals as may be required.
- Check power settings to all component parts before connection.

### DISCLAIMER

There is no implied or expressed warranty regarding this material.



## 2. GENERAL SPECIFICATION

No.	Item	Description	
1	Controller name	NCB220E	640*480, 800*600, 1024*768, 1440* 900, 1280*1024, 1680*1050 Panel support
2	LCD Module	VGA, SVGA, XGA, WXGA+, SXGA, WSXGA+ LVDS Interface TFT LCD	
3	Signal Input	NCB220E1 (or SMD type) : Analog RGB input NCB220E2 : Analog RGB input & DVI input	
4	Resolution Support	H: 31 ~ 61kHz	
		V: 55 ~ 76Hz	
5	OSD Control	Menu, Select, Down, Up, Power	
	Plug & Play	VESA DDC 1/2B Ver1.3	
6	Power Connector	Input	IEC320 Male 3 line connector
7.	Power Consumption	Supply Voltage	12Vdc
		Max Power	Note2)
8	Signal Connector	Analog	D-SUB 15P
9	LED status	Green	Normal state
		Amber	DPMS state
		Off	Power off

Note2) Max Power is depending on the subject display to be used.

## 3. ELECTRICAL SPECIFICATION

### 3.1 Absolute Maximum Rating

Item	Unit	Min.	Typical	Max.	Remarks
Operation Temperature	°C	0	-	60	
Storage Temperature	°C	-30	-	80	
Relative Humidity	%		-	90	

### 3.2 Input characteristic

Description	Signal	Unit	Min	Typical	Max	Remarks
Power In (12Vdc)	Input	Vdc	11.4	12	12.6	
	Consumption	Watt			5	Board only
RGB Input	Analog RGB	Vp-p	0		0.7	
	Sync	Vdc	0		5.5	
	H Frequency	KHz	31		65.2	Depends on Mode
	V Frequency	Hz	55	60	75	

### 3.3 Output Characteristics

Description	Signal	Unit	Min	Typical	Max	Remarks
LVDS Interface						
	Differential output	mVp-p	250	350	450	
	LCD Power (3.3V)	Vdc	3.16	3.3	3.5	Jumper option
	LCD Power (5V)	Vdc	4.5	5.0	5.5	Jumper option
	LCD Power (12V)	Vdc	11.4	12.0	12.6	Jumper option
Inverter Interface						
	Power out	Vdc	11.4	12.0	12.6	
	On/Off control	Vp-p	0		3.3	L=off, H=on
	Bright control	Vp-p	0		4.0	

## 4. BLOCK DIAGRAM

### 4.1 NCB220E1 Block Diagram

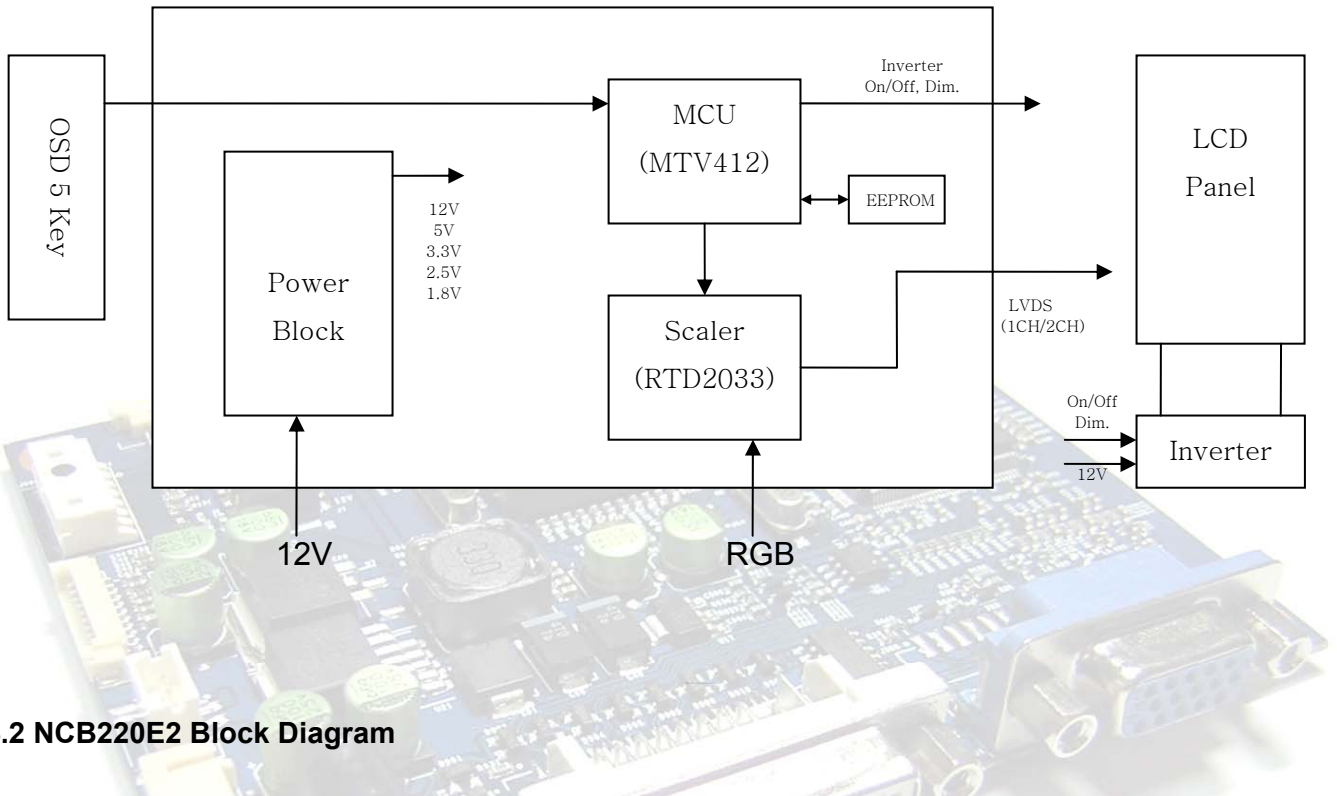

### 4.2 NCB220E2 Block Diagram

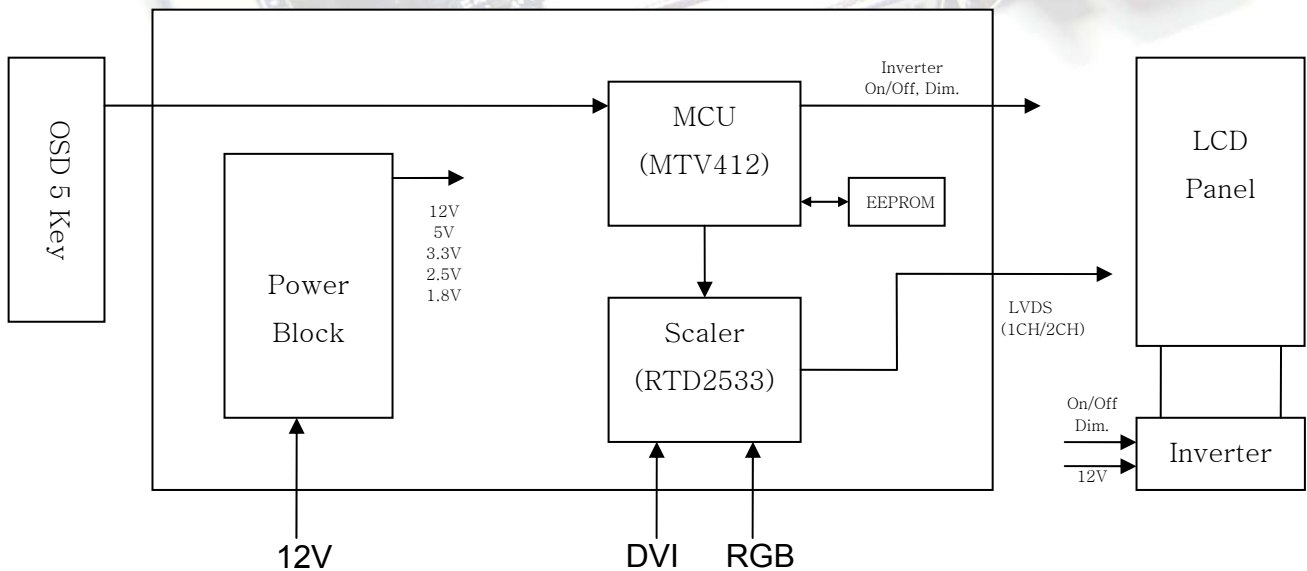

### 5. CONNECTION CABLE

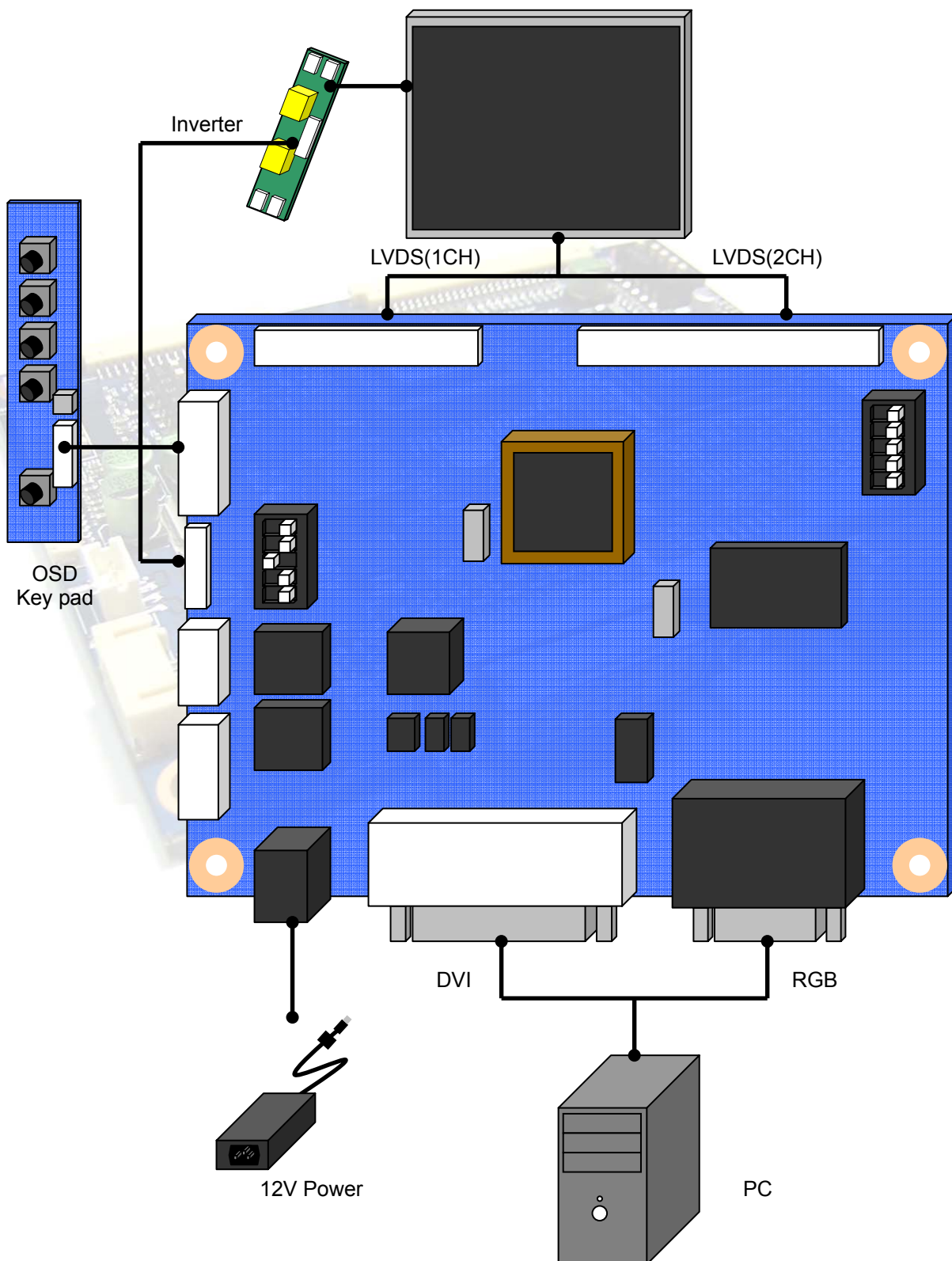



## 6. ASSEMBLY NOTES

This controller is designed for monitors and custom display projects using 1680x1050, resolution TFT LCD panels with a VGA, SVGA, XGA, WXGA+, SXGA, WSXGA+ signal input. The following provides some guidelines for installation and preparation of a finished display solution.

**Preparation:** Before proceeding it is important to familiarize yourself with the parts making up the system and the various connectors, mounting holes and general layout of the controller. As much as possible connectors have been labeled. Guides to connectors and mounting holes are shown in the following relevant sections.

- 1. LCD panel:** This controller has 12V, 5V or 3.3V LVDS interface logic on the Board for different kind of TFT LCD panel. For the other type of LCD interface like Panel Link interface and etc, this board can accommodate a daughter board instead of on-board LCD interface. Due to the different signal timing and electrical characteristics from each LCD panel manufacturer, for selecting LCD interface type and resolution, put jumper marked J5 on the right position following LCD panel specification. For selecting DC power level, put jumper marked J7 on the right position. Supplied power level depends on LCD panel specification.
- 2. Controller:** Handle the controller with care as static charge may damage electronic components, Make sure correct jumper and switches settings to match the target LCD panel
- 3. LCD connector board:** Different makers and models of LCD panel require different panel signal connectors and different pin assignments.
- 4. LCD signal cables:** In order to provide a clean signal it is recommended that LCD signal cables should not be longer than 30cm. If loose wire cabling is utilized these can be made into a harness with cable ties. Care should be taken when you place the cables to avoid signal interface. Additionally it may be necessary in some systems to add ferrite cores to the cables to minimize signal noise.
- 5. Inverter:** This will be required for the backlight of an LCD, some LCD panel have an inverter built in. As LCD panels may have 1 or more backlight tubes and the power requirements for different panel backlights may vary, it is important to match the inverter in order to obtain optimum performance. See application notes for more information on connection.
- 6. Inverter cable:** Different inverter models require different cables and different pin assignment. Make sure the correct cable pin out to match the inverter. Unsuitable cable pins out may damage the inverter.
- 7. OSD button:** See Operational Function section.

**8. 3 Color LED:** This LED shows the state of controller.

- Green – Normal state
- Off – Off mode
- Amber – DPMS mode

**9. Power switch:** This switch is located on OSD button board.

**10. Power input:** +12Vdc is required to supply power for the controller, the Inverter and the LCD panel

**11. VGA input cable:** As this may affect regulatory emission test result, a suitably shielded cable should be utilized.

**EMI:** Shielding will be required for passing certain regulatory emissions tests. Also the choice of video board and power supply can affect the test result.

**Consideration should be given to:**

- Electrical insulation.
- Grounding.
- EMI shielding.
- Heat & ventilation

**Caution:** Ensure that the equated insulation is provided for all areas of the PCB with special attention to high voltage parts such as the inverter.

**\*\*\* Remarks\*\*\***

For a specific panel use, One LCD panel sample and full technical specifications for the LCD panel from the manufacturer are required to test for tuning up screen image. **Innodisplay** can provide engineering service for customers specific controller development.

Please contact Innodisplay. (sohn@innodisplay.co.kr)

**12. Setup for operation**

Once the circuit has been connected, a setup procedure for optimal requires a few minutes the following instructions are likely to form the basis of the finished product operation manual.

**PC settings**

The PC needs to be set to an appropriate graphics mode that has the same resolution with the LCD panel to have clear screen image. And the vertical refresh rate should be set to one of 56~75Hz, non-interlaced signal.

**LCD display system settings**

The OSD (On Screen Display) provides certain functions to have clear image and others. This board supports 5 buttons OSD operation as a standard. The control functions defined on OSD operation are as below.

**PC Graphics Output:** A few guidelines:

- Signal quality is very important, if there is noise or instability in the PC graphics output this may result in visible noise on the display
- Refer to the graphic modes table in specification section for supported modes.
- Non-interlaced & interlaced video input is acceptable.

**Important: please read the application notes section for more information.**

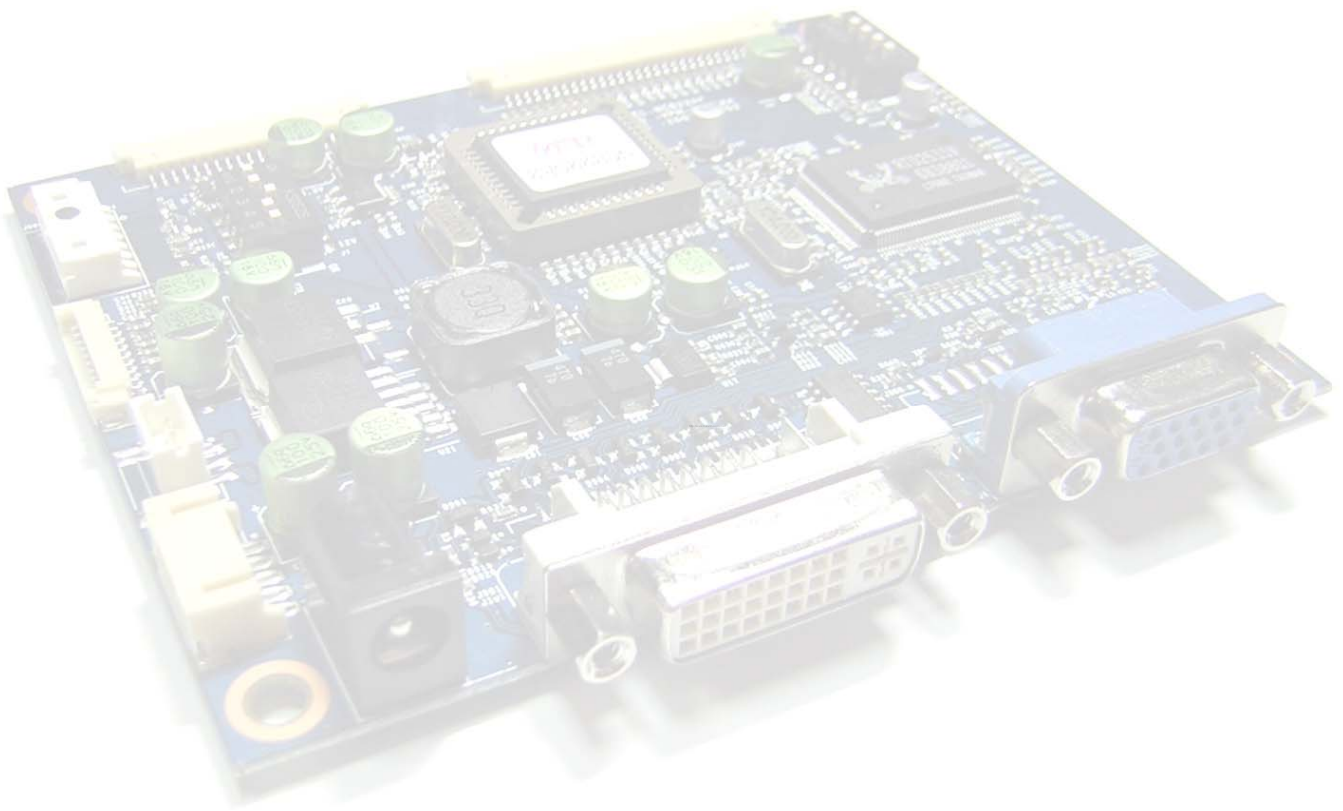

**7. OSD MENU**

**7.1 OSD GUI**

**Brightness / Contrast**

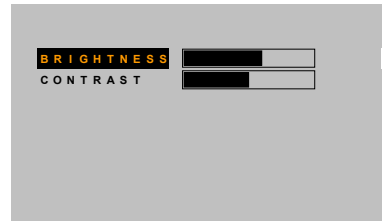

Select the Brightness or Contrast.

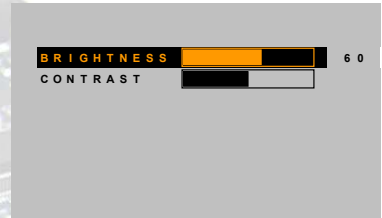

To adjust screen brightness or contrast.

**Color (Not selectable on DVI mode)**

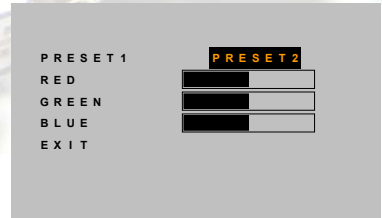

Select color temperature 6500K / 9300K / user mode.

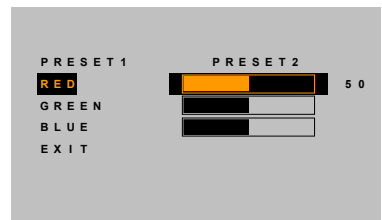

Color temperature is adjustable as wished by user.



Position (Not selectable on DVI mode)

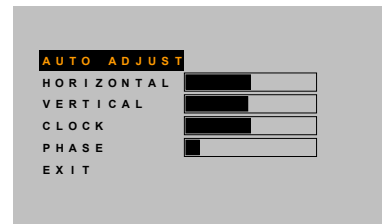

Select screen position option.

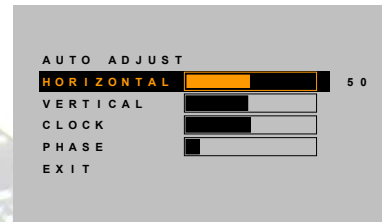

Adjustment for screen position, clock and phase.

Setup

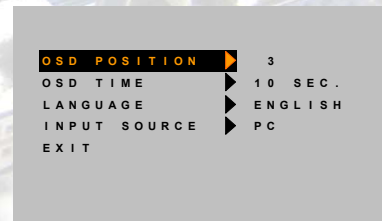

Select OSD window option.

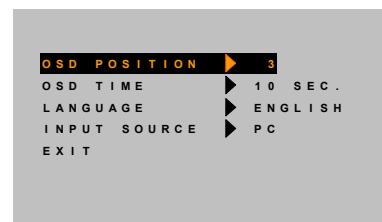

Adjust OSD window position, time, language and source change.

## 7.2 OSD GUI Control Table

Main Menu	Sub Menu	Description
BRIGHTNESS/ CONTRAST	BRIGHTNESS	To adjust screen brightness
	CONTRAST	To adjust screen contrast
COLOR	PRESET1	Color temperature 9300K
	PRESET2	Color temperature 6500K
	RED/GREEN/BLUE	Color temperature adjustable as wished by user
POSITION	AUTO ADJUST	Execute AUTO function
	HORIZONTAL	To adjust screen horizontal position
	VERTICAL	To adjust screen vertical position
	CLOCK	To adjust screen clock
	PHASE	To adjust screen phase
SETUP	OSD POSITION	To adjust OSD menu position
	OSD TIME	To adjust open time for OSD menu (3~60 sec.)
	LANGUAGE	Language selectable by user (English/Deutsch/François/Italiano/Espanol/Portuguese)
	INPUT SOURCE	Selectable input source RGB or DVI

### 7.3 Operation Message

#### OUT OF FREQUENCY

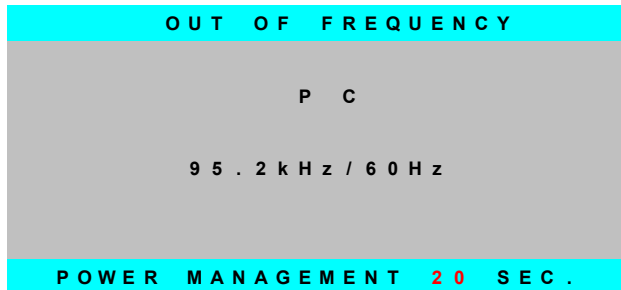

This is when Input Signal is over the range or frequency.

#### NO SIGNAL



This is when Input Signal is not present. This message is disappeared after 5 seconds.

#### CHECK SIGNAL CABLE

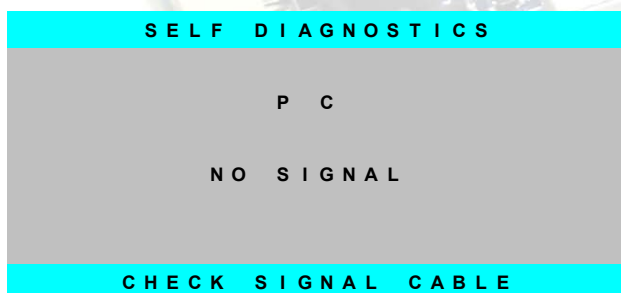

This is when Input Signal is not present after power on with power switch.

This message is not disappeared before power off or activity of input signal

## Factory Reset



F a c t o r y   R e s e t

When pressing MENU button for 5 seconds or more, then factory reset is being implemented.  
Use to reset all the menu option (user section setting values) to their original factory preset values.

## AUTO CONFIGURATION



P R O C E S S I N G  
A U T O   C O N F I G R A T I O N

Execute AUTO Function

The chosen OSD settings will be stored in memory. The OSD menu can be cleared from the screen from the screen by moving the selection bar to the **EXIT MENU** icon pressing the **SEL** button or **MENU** key pressing otherwise it will be automatically cleared after a few second of no use.



## 8. CONNECTION & OPERATION

**CAUTION:** Never connect or disconnect parts of the display system when the system is powered up as this may cause serious damage.

### CONNECTION

1. **LCD panel & Inverter:** Connect the inverter (if it is not built-in the panel) to the CCFT lead connector of the LCD panel.
2. **LVDS type panels:** Plug the signal cables direct to J100 for single channel interface panel or J802 for dual channel interface panel. Plug the other end of cables to the LCD connector board.
3. **Inverter & Controller:** Plug the inverter cable to J3 of the controller board and another end to the connector on the inverter.
4. **Function switch & Controller:** Plug the OSD switch mount cable to CN104(J906) of the controller board and another end to the OSD board.
5. **Jumpers & Switch:** Check all switches and also if J7 (Target panel power is setting) and J5 (Target panel resolution setting) are set correctly. Details referring the switches setting table (in the following section).
6. **VGA cable & Controller:** Plug the VGA cable to the connector J6(J4) of the controller board.
7. **DVI-D cable & Controller:** Plug the DVI-D cable to the connector J901 of the controller board.
8. **Power supply & Controller:** Plug the DC 12V power in to the connector J2 or J902.
9. **Power on:** Switch on the controller board and panel by using the OSD switch mount.

### General:

- If you use supplied cables & accessories, ensure that they are correct for the model of the panel and the controller.
- If you make your own cables & connectors, refer carefully to both the panel & inverter specifications and the section in this manual, "Connectors, Pin outs & Jumpers" to ensure the correct pin to pin wiring.

### PC Setting:

The controller has been designed to take a very wide range of input signals however to optimize the PC's graphic performance we recommend choosing 60Hz vertical refresh rate – this will not cause screen flicker.

**9. CONNECTOR, PINOUT & JUMPERS**

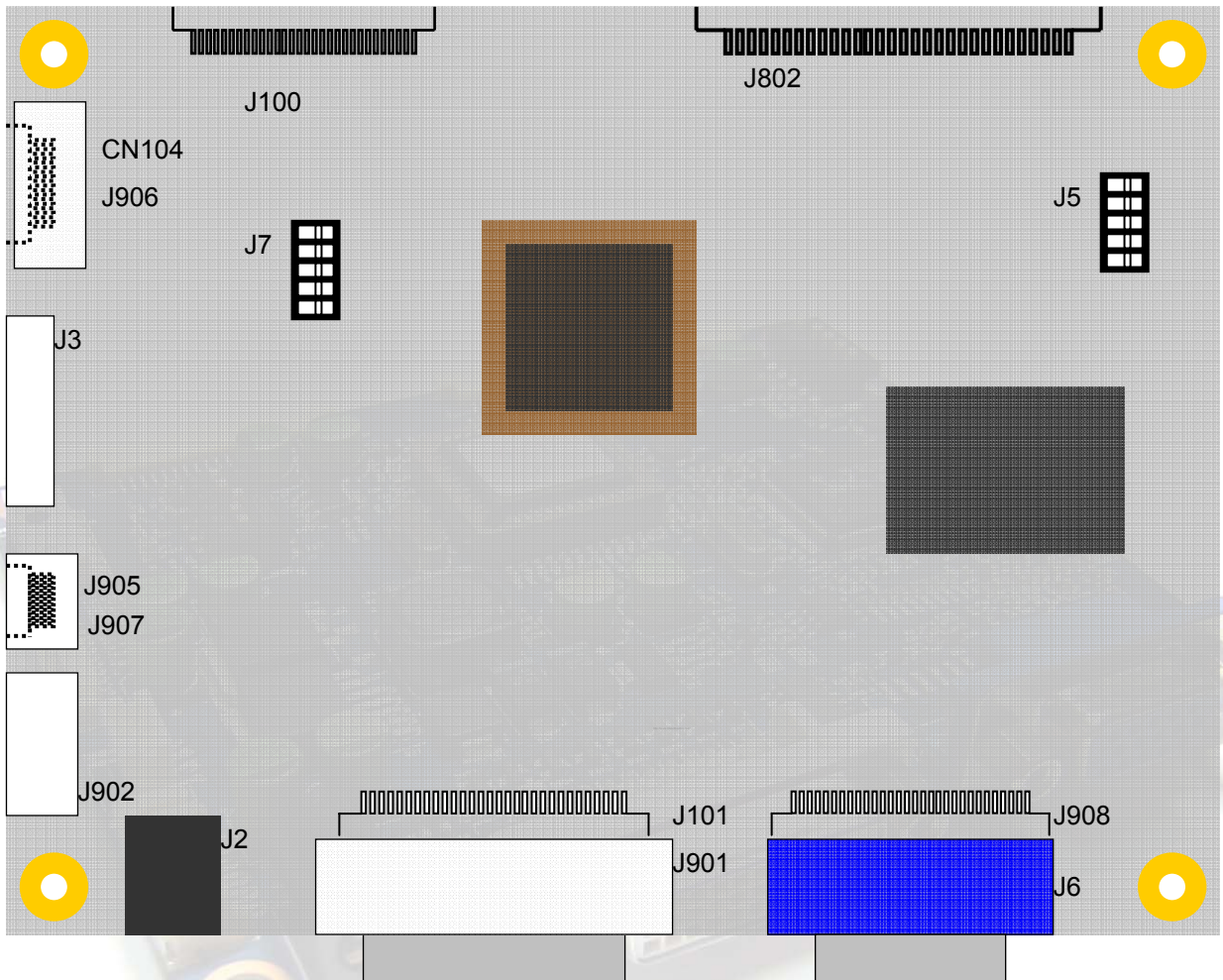

## 9.1 Summary : Connector & Switch

L/No.	Description	Connector Type	Remark
J2	Input DC power Jack	DJ05H-250Y (2.5 Ø)	Note1
J3	Inverter Connector	YEON-HO 12505WR-10A00 10P 1.25mm	
J5	Panel Type Select Switch	HDR5x2, SMD, 10Pin	
J6	Analog RGB Connector	15P D-SUB	
J7	Panel Power Out Select Switch	HDR5x2, SMD, 10Pin	
J100	LCD interface board Connector for LVDS 1ch	YEON-HO 12507WR-20 20P 1.25mm	
J101	DVI-D Signal Input Connector	YEON-HO 12507WR-20 20P 1.25mm	Note1
J802	LCD interface board Connector for LVDS 2ch	YEON-HO 12507WR-30 30P 1.25mm	
J901	DVI-D Connector	DVI-D24P	Note1
J902	Input DC Power Connector	YEON-HO 20022WR-05A00 5P 2mm	
J905	Output DC Power Connector	YEON-HO 20022WR-05A00 5P 2mm	Note1
J906	OSD control Connector	YEON-HO 12505WR-07A00 7P 1.25mm	Note1
J907	Output DC Power Connector	YEON-HO 20017WR-0510 5P 2mm	Note1
J908	RGB Signal Input Connector	YEON-HO 20022WR-13A00 13P 2.0mm	Note1
CN104	OSD control Connector	YEON-HO 20017WR-0710 7P 2mm	Note1

Note1) Option SMD type board only.

- Remove J2/J6/J901/J905/CN104
- Insert J101/J906/J907/J908

## 9.2 Connector Pin Assignment

### J2 : Input Dc power Jack

Pin No.	Symbol	Description
1	Vcc	12V
2,3	GND	Ground

### J3 : Inverter Connector

Pin No.	Symbol	Description
1	DIM-ADJ	DIM-adjustment
2	GND	Ground
3	GND	Ground
4	GND	Ground
5	ON/OFF	Inverter ON/OFF
6	GND	Ground
7	GND	Ground
8	GND	Ground
9	Vcc	12V
10	Vcc	12V

### J5 : Panel Type Select Switch

**\* Refer to 9.3 On/Off Switch Assignment**

### J6 : Analog RGB Connector

Pin No.	Symbol	Description
1	Red1	Red analog input
2	Green1	Green analog input
3	Blue1	Blue analog input
4	GND	Ground
5	GND	Ground
6	GND	Ground
7	GND	Ground
8	GND	Ground
9	NC	Not connected



10	GND	Ground
11	GND	Ground
12	DSDA	DDC-SDA
13	HSYNC	Horizontal Sync
14	VSYNC	Vertical Sync
15	DSCL	Serial Clock Input

**J7 : Panel Power Out Select Switch**

**\* Refer to 9.3 On/Off Switch Assignment**

**J100 : LCD interface board Connector for LVDS 1ch**

Pin No.	Symbol	Description
1	GND	Ground
2	GND	Ground
3	Y3P	LVDS 3 Channel Positive Signal for LCD Module (6Bit Unused)
4	Y3M	LVDS 3 Channel Negative Signal for LCD Module (6Bit Unused)
5	GND	Ground
6	CLKOUTP	LVDS Clock Positive Signal of Channel for LCD Module
7	CLKOUTM	LVDS Clock Negative Signal of Channel for LCD Module
8	GND	Ground
9	Y2P	LVDS 2 Channel Positive Signal for LCD Module
10	Y2M	LVDS 2 Channel Negative Signal for LCD Module
11	GND	Ground
12	Y1P	LVDS 1 Channel Positive Signal for LCD Module
13	Y1M	LVDS 1 Channel Negative Signal for LCD Module
14	GND	Ground
15	Y0P	LVDS 0 Channel Positive Signal for LCD Module
16	Y0M	LVDS 0 Channel Negative Signal for LCD Module
17	GND	Ground
18	GND	Ground
19	MOD_PWR	VDD For LCD Module
20	MOD_PWR	VDD For LCD Module

## J101 : DVI-D Signal Input Connector(SMD Type Board option)

Pin No.	Symbol	Description
1	GND	Ground
2	HPD	Identify the presence of a monitor
3	TMDS DATA2+	TMDS DATA2 Differential Positive Signal
4	TMDS DATA2-	TMDS DATA2 Differential Negative Signal
5	TMDS DATA2 Shield	Shield for TMDS Channel #2
6	TMDS DATA1+	TMDS DATA1 Differential Positive Signal
7	TMDS DATA1-	TMDS DATA1 Differential Negative Signal
8	TMDS DATA1 Shield	Shield for TMDS Channel #1
9	GND	Ground
10	TMDS DATA0+	TMDS DATA0 Differential Positive Signal
11	TMDS DATA0-	TMDS DATA0 Differential Negative Signal
12	TMDS DATA0 Shield	Shield for TMDS Channel #0
13	TMDS CLOCK+	TMDS DATA0 Differential Positive Signal
14	TMDS CLOCK-	TMDS DATA0 Differential Negative Signal
15	TMDS CLOCK Shield	Shield for TMDS Clock differential Pair
16	+5V Power	+5 Volt signal for EDID (Un-powered Monitor)
17	NC	No Connection
18	DDC Clock	The Data Line for the DDC Interface
19	DDC Data	The Clock Line for the DDC Interface
20	GND	Ground

## J802 : LCD interface board Connector for LVDS 2ch

Pin No.	Symbol	Description
1	MOD_PWR	Panel Power
2	MOD_PWR	Panel Power
3	MOD_PWR	Panel Power
4	MOD_PWR	Panel Power
5	GND	Ground
6	NC	NC
7	GND	Ground
8	Y3P-EVEN	Positive(+) LVDS differential first 3 data(A port)

9	Y3M-EVEN	Negative(-) LVDS differential first 3 data(A port)
10	YCP-EVEN	Positive(+) LVDS differential first Clock(A port)
11	YCM-EVEN	Negative(-) LVDS differential first Clock(A port)
12	Y2P-EVEN	Positive(+) LVDS differential first 2 data(A port)
13	Y2M-EVEN	Negative(-) LVDS differential first 2 data(A port)
14	GND	Ground
15	Y1P-EVEN	Positive(+) LVDS differential first 1 data(A port)
16	Y1M-EVEN	Negative(-) LVDS differential first 1 data(A port)
17	YOP-EVEN	Positive(+) LVDS differential first 0 data(A port)
18	Y0M-EVEN	Negative(-) LVDS differential first 0 data(A port)
19	GND	Ground
20	Y3P-ODD	Positive(+) LVDS differential second 3 data(B port)
21	Y3M-ODD	Negative(-) LVDS differential second 3 data(B port)
22	YCP-ODD	Positive(+) LVDS differential second Clock(B port)
23	YCM-ODD	Negative(-) LVDS differential second Clock(B port)
24	Y2P-ODD	Positive(+) LVDS differential second 2 data(B port)
25	Y2M-ODD	Negative(-) LVDS differential second 2 data(B port)
26	GND	Ground
27	Y1P-ODD	Positive(+) LVDS differential second 1 data(B port)
28	Y1M-ODD	Negative(-) LVDS differential second 1 data(B port)
29	YOP-ODD	Positive(+) LVDS differential second 0 data(B port)
30	Y0M-ODD	Negative(-) LVDS differential second 0 data(B port)

### J901: DVI-D Connector

Pin No.	Symbol	Description
1	TMDS DATA2-	TMDS DATA2 Differential Negative Signal
2	TMDS DATA2+	TMDS DATA2 Differential Positive Signal
3	TMDS DATA2 Shield	Shield for TMDS Channel #2
4	NC	No Connection
5	NC	No Connection
6	DDC Clock	The Data Line for the DDC Interface
7	DDC Data	The Clock Line for the DDC Interface
8	NC	No Connection
9	TMDS DATA1-	TMDS DATA1 Differential Negative Signal

10	TMDS DATA1+	TMDS DATA1 Differential Positive Signal
11	TMDS DATA1 Shield	Shield for TMDS Channel #1
12	NC	No Connection
13	NC	No Connection
14	+5V Power	+5 Volt signal for EDID (Un-powered Monitor)
15	GND(for +5V)	Ground for +5 Volt Power pin, Sync return
16	HPD	Identify the presence of a monitor
17	TMDS DATA0-	TMDS DATA0 Differential Negative Signal
18	TMDS DATA0+	TMDS DATA0 Differential Positive Signal
19	TMDS DATA0 Shield	Shield for TMDS Channel #0
20	NC	No Connection
21	NC	No Connection
22	TMDS CLOCK Shield	Shield for TMDS Clock differential Pair
23	TMDS CLOCK+	TMDS DATA0 Differential Positive Signal
24	TMDS CLOCK-	TMDS DATA0 Differential Negative Signal

### J902: Input DC Power Connector

Pin No.	Symbol	Description
1	12V	12V
2	12V	12V
3	N.C	N.C
4	GND	Ground
5	GND	Ground

### J905 : Output Dc power Connector(SMD Type Board Option)

Pin No.	Symbol	Description
1,2	12V	12V
3	GND	Ground
4,5	5V	5V



### J906 : OSD control Connector(SMD Type Board option)

Pin No.	Symbol	Description
1	VCC	+5V power for IR sensor
2	IRQ	Infrared rays signal line.
3	LED2	RED LED
4	LED1	GREEN LED
5	GND	Ground
6	KEY1	Up, Power
7	KEY0	Menu, Select, Down

### J907 : Output Dc power Connector

Pin No.	Symbol	Description
1,2	12V	12V
3	GND	Ground
4,5	5V	5V

### J908 : RGB Signal Input Connector(SMD Type Board option)

Pin No.	Symbol	Description
1	HSYNC	Horizontal Sync
2	GND	Ground
3	VSYNC	Vertical Sync
4	NC	No Connection
5	BLUE	Blue Analog Input Signal
6	BLUE GND	Ground for Blue Analog Input Signal
7	GREEN	Green Analog Input Signal
8	GREEN GND	Ground for Green Analog Input Signal
9	RED	Red Analog Input Signal
10	RED GND	Ground for Red Analog Input Signal
11	SCL	Serial Clock Line for DDC
12	SDA	Serial Data Line for DDC
13	A-DET	No Connection

### CN104 : OSD control Connector

Pin No.	Symbol	Description
1	VCC	+5V power for IR sensor
2	IRQ	Infrared rays signal line.
3	LED2	RED LED
4	LED1	GREEN LED
5	GND	Ground
6	KEY1	Up, Power
7	KEY0	Menu, Select, Down

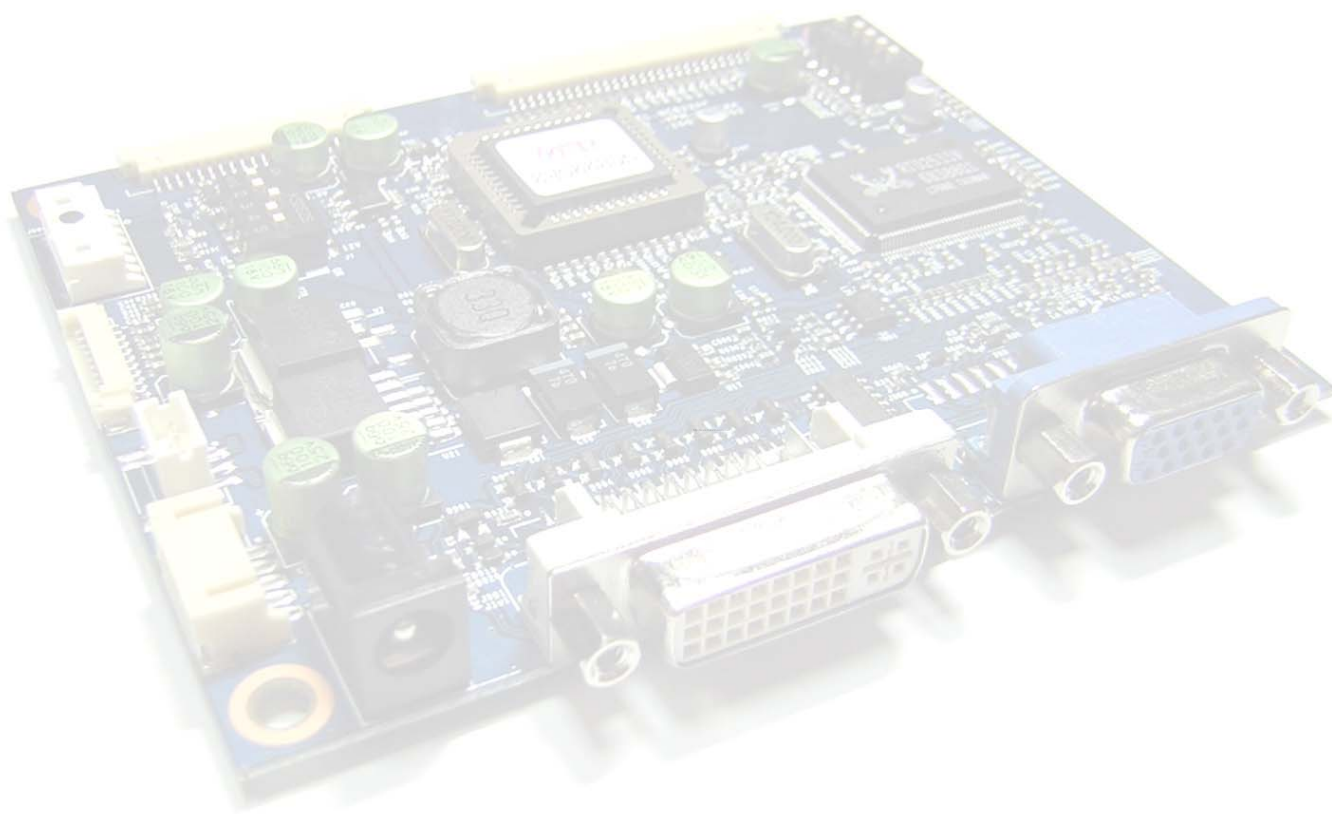

## 9.3 On/Off Switch Assignment

### Panel Type setting switch

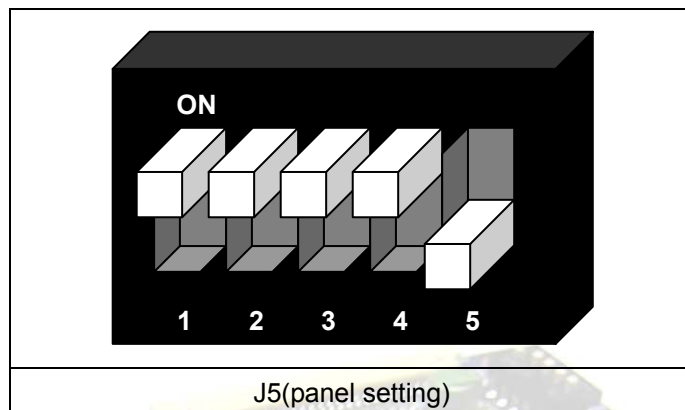

### Standard Panel Jumper Setting

Resolution setting			Mode setting					
1	2	resolution	3(LVDS MAP)		4(Color depth)		5(Signal type)	
ON	ON	VGA	ON	Shift	ON	6bit	ON	Special
ON	OFF	SVGA						
OFF	ON	XGA	OFF	Normal	OFF	8bit	OFF	Normal
OFF	OFF	SXGA						

### Special Panel Jumper Setting

If any certain display can not be driven as per Standard Panel Jumper Setting, then please check below different panel setting per each panel and re-set the jumper to drive properly

No.	1	2	3	4	5	Panel name	Vendor	Resolution	Remark
1	1	1	1	1	1	640*480 LVDS 6bit			
2	1	1	1	0	1	1024*768 LVDS 6bit			
3	1	1	0	1	1	1280*800 LVDS 6bit			
4	1	1	0	0	1	LB064 TTL 6bit	LG	640*480	
5	1	0	1	1	1	HT10X21 LVDS 6bit	BOE HYDIS	1024*768	
6	1	0	1	0	1	800*480 LVDS 6bit			
7	1	0	0	1	1	800*600 LVDS 6bit			
8	1	0	0	0	1	1280*1024 LVDS 8bit Shift			
9	0	1	1	1	1	1280*768 LVDS 8bit			
10	0	1	1	0	1	1366*768 LVDS 8bit			
11	0	1	0	1	1	1920*1200 LVDS 8bit			Option

12	0	1	0	0	1	1400*1050 LVDS 8bit			
13	0	0	1	1	1	1680*1050 LVDS 6bit Shift			
14	0	0	1	0	1	1400*900 LVDS 6bit Shift			
15	0	0	0	1	1	1680*1050 LVDS 8bit Normal			
16	0	0	0	0	1	1400*900 LVDS 8bit Normal			
17									

\*J5(ON=1, OFF=0)

**Panel Power Out Setting switch**

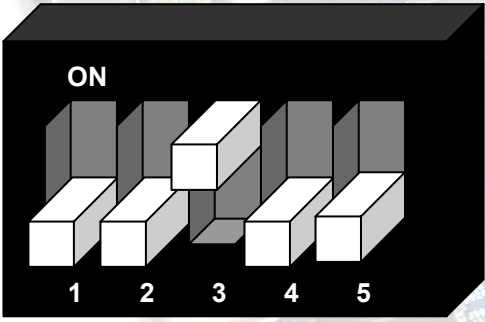
	Power Setting	Switch No.					<b>CAUTION:</b> Incorrect setting can damage panel. Please make sure to check the panel specs.
		1	2	3	4	5	
	3.3V	on	off	off	off	off	
	5.0V	off	off	on	off	off	
	12V	off	off	off	off	on	
J7(Panel power setting)							



### 10. CONTROLLER DIMENSIONS

(unit : mm)

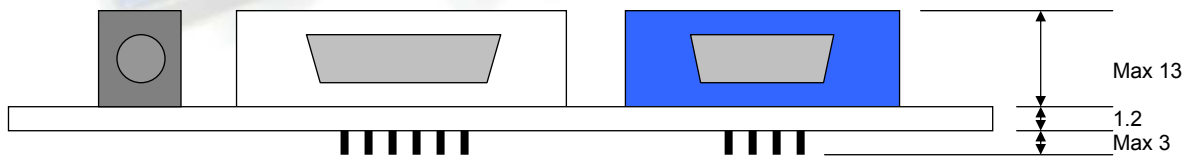
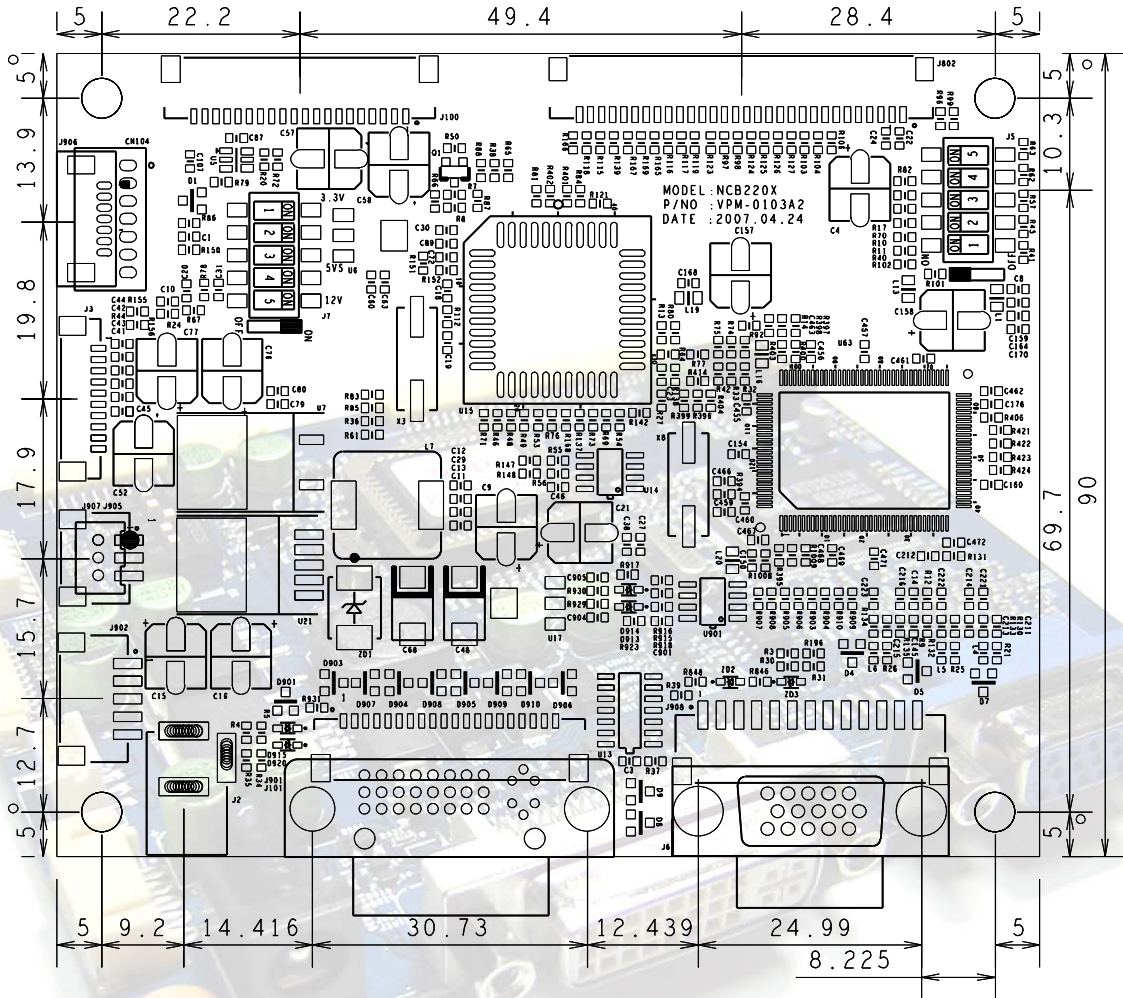

Standard Type (RGB, OSD, DVI, and Power-out)

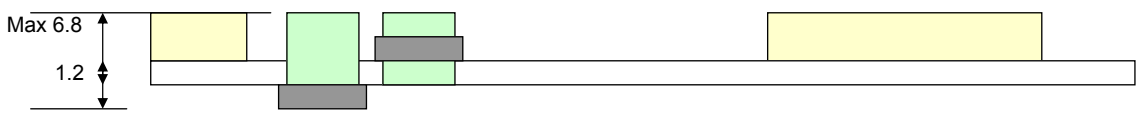

SMD Type

## 11. APPLICATION NOTES

### INVERTER CONNECTION

There are 3 potential issues to consider with inverter connection:

- Power
- ON/OFF
- Brightness (DIM-ADJ)

**Inverter power:** This should be matched with the inverter specification.

**Inverter ON/OFF:** This is a pin provided on some inverter for ON/OFF function and is used by this panel controller for VESA DPMS compliance. If the inverter does not have on/off pin or the on/off pin is not used DPMS will not operate. Pin 5 should be matched to the inverter specification for the ON/OFF pin.

**Brightness Dimming control:** NCB220E controller boards are analog dimming control method. And it is important to consider the specifications for the inverter to be used.

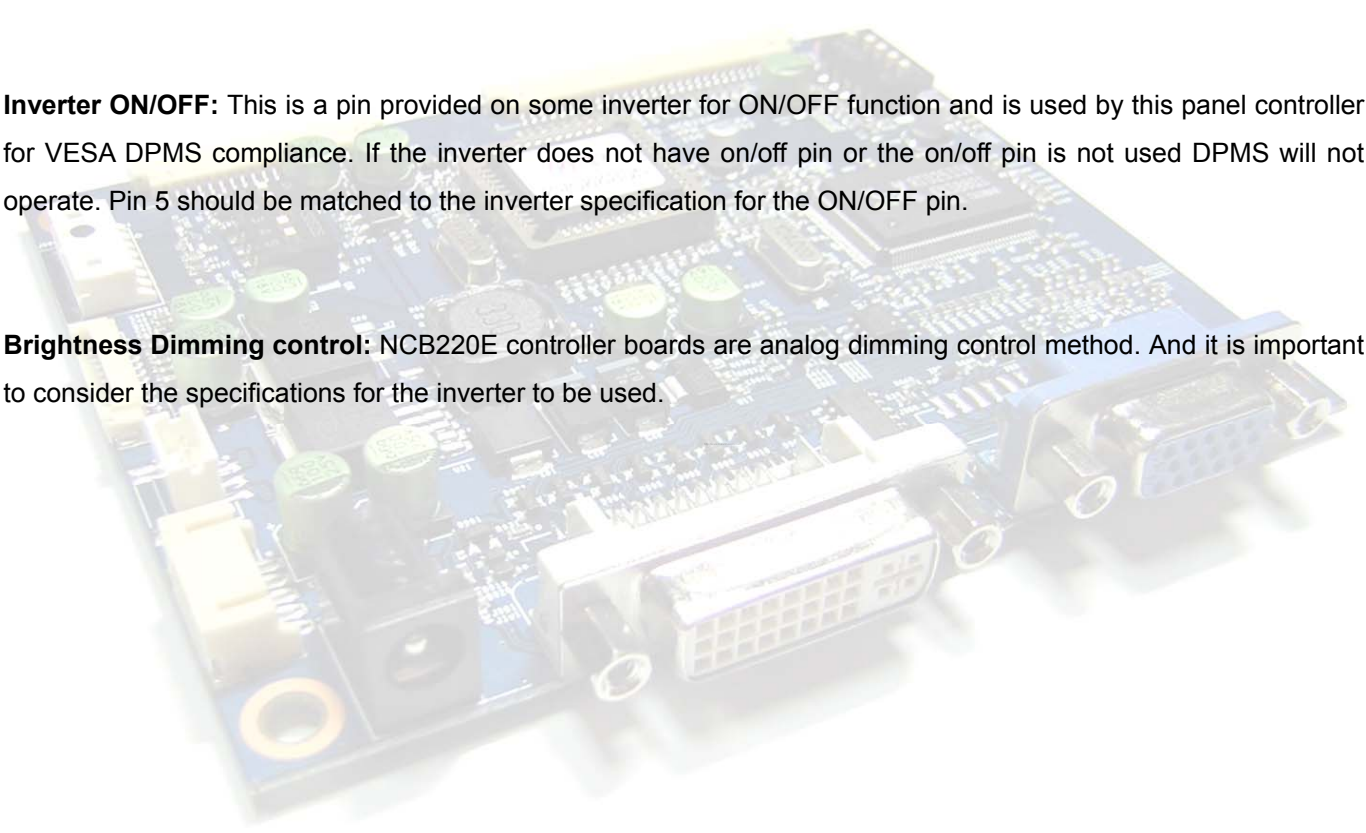

## 12. TROUBLESHOOTING

### General

A general guide to troubleshooting of a flat panel display system, worthy of considering the system as separate elements, such as:

- ▶ Controller (jumpers, PC settings)
- ▶ Panel (controller, cabling, connection, panel, PC settings)
- ▶ Backlight (inverter, cabling, connection, panel, Pc settings)
- ▶ Cabling
- ▶ Computer system (display settings, operating system)

Through checking the system step-by-step cross with instruction manuals and a process of elimination to isolate the problem it is usually possible to clearly identify the problem area.

### No image:

- ▶ If the panel backlight is not working it may still be possible to see just some image.
- ▶ A lack of image is most likely to be caused by incorrect connection, lack of power, failure to provide a signal or incorrect graphic card settings.

### Image position:

If it is impossible to position the image correctly, the image adjustment controls will not move the image far enough, then test using another graphics card. This situation can occur when a graphic card is not close to standard timing or when something is in the graphics line that may affect the signal such as a signal splitter (please note that normally a signal splitter will not have any adverse effect).

### Image appearance:

- ▶ A faulty panel can have blank lines, failed sections, flickering or flashing display.
- ▶ Incorrect graphic card refresh rate, resolution or interlaced mode will probably cause the image to be the wrong size, to scroll to, flicker badly or possibly even no image.
- ▶ Incorrect jumper settings on the controller may cause everything from incorrect image viewing to total failure.

**CAUTION:** Do not set the panel power input incorrectly.

- ▶ Sparkling on the display: faulty panel signal cable.

### Backlight:

Items to check include: Power input, controls, inverter and Tubes generally in this order.

If half the screen is dimmer than the other half:

- ▶ Check cabling for the inverter.

Also:

- ▶ If system does not power down when there is a loss of signal.

### 13. ACCESSORY

This board requires several accessories to build a complete display unit. **Innodisplay** can provide standard accessory for this board as below.

No.	Items	Part No.	Ex) LG Philips LM150X08
1	LCD signal cable	VSC-Panel Part No.-Cm	VSC-LM150X08-30
2	Inverter	Part no. of Manufacturer	DS-1305WK
3	Inverter cable	VIC-Inverter Part No.-Cm	VIC-DS1305WK-20
4	OSD Board	NOB005P	NOB005P
5	OSD Cable	VOC-OSD B/D-Cm	VOC-NOB005P-20

\* **VSC:** LCD Signal Cable

**VIC:** Inverter Interface Cable

**VOC:** OSD Board Cable

**Cm :** Cable length(unit: Cm)

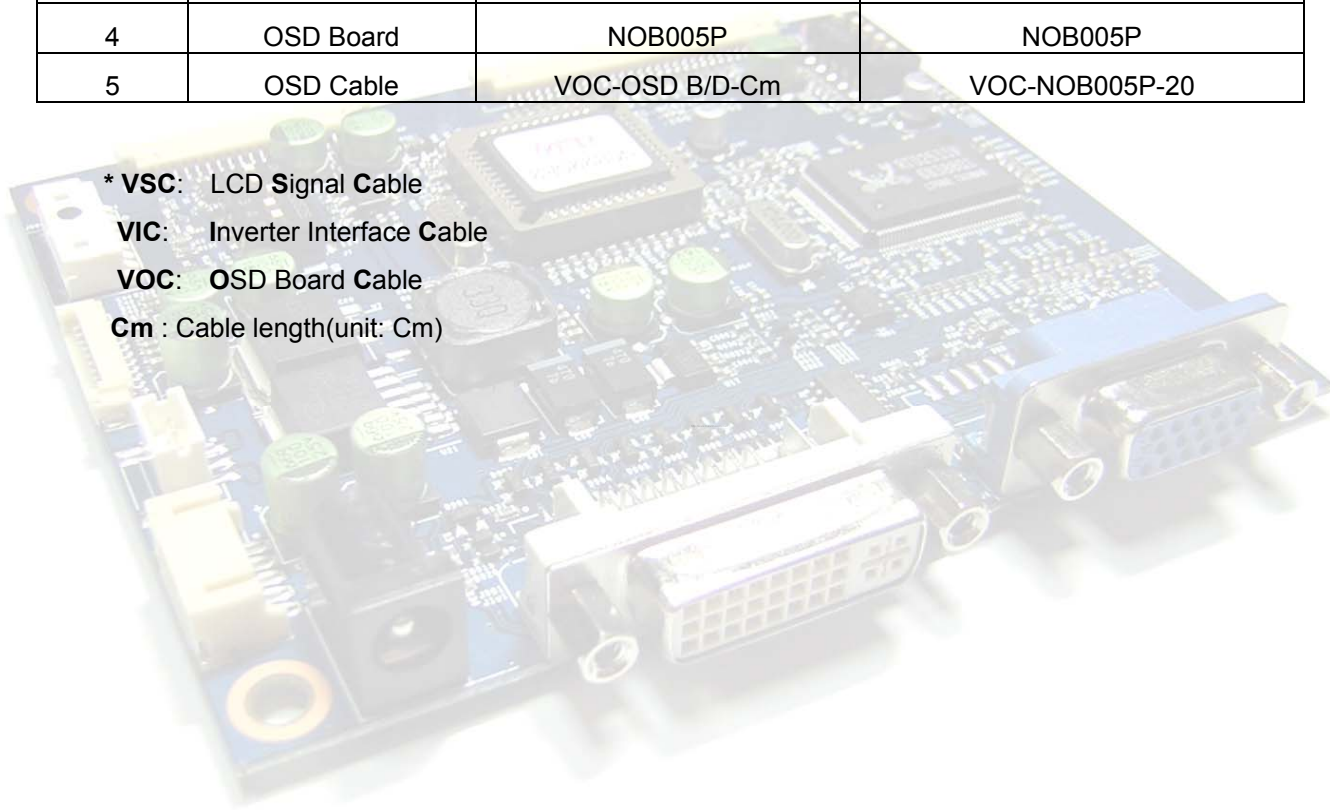



## 13.1 OSD Board

The OSD (On Screen Display) provides certain functions to have clear image and others. This board supports 5 buttons OSD operation as a standard. The control functions defined on OSD operation are as below. (unit: mm)

### Appearance

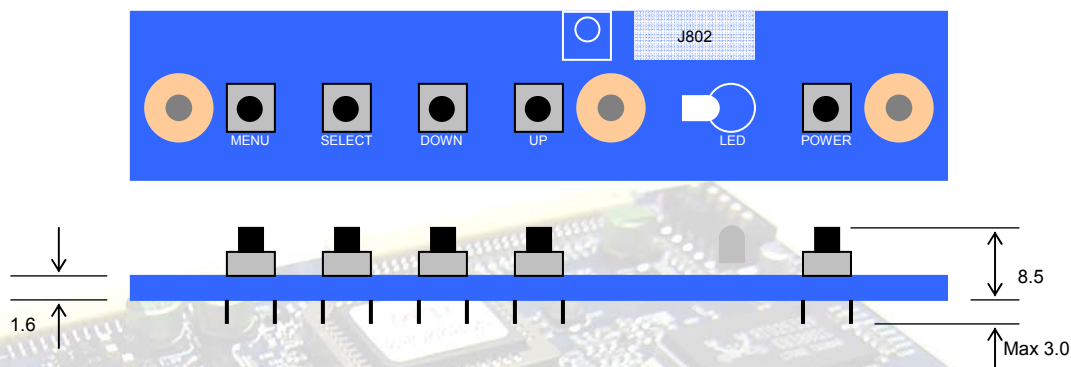

Button	Function	Status	HOT Key
Power	Power on/off	On/Off	
Menu	Activate menu		
Select	Menu Select		Auto setting
LED	Indicates operation status	Green/ Off/ Amber	
DOWN, UP ▼ ▲	Cursor control (Value Control) Down (Decrement)/Up (Increment)		UP: Source change

### J1 : OSD control connector

Pin No.	Symbol	Description
1	KEY0	Menu, Select, Down
2	KEY1	Up, Power
3	GND	Ground
4	LED1	GREEN LED
5	LED2	RED LED
6	IRQ	Infrared rays signal line.
7	VCC	+5V power for IR sensor