

NCE N-Channel Enhancement Mode Power MOSFET

Description

The NCE0130KA uses advanced trench technology and design to provide excellent $R_{DS(ON)}$ with low gate charge. It can be used in a wide variety of applications.

General Features

- $V_{DS} = 100V, I_D = 30A$
 $R_{DS(ON)} < 31m\Omega @ V_{GS}=10V$ (Typ:27m Ω)
- Special process technology for high ESD capability
- High density cell design for ultra low R_{dson}
- Fully characterized avalanche voltage and current
- Good stability and uniformity with high E_{AS}
- Excellent package for good heat dissipation

Application

- Power switching application
- Hard switched and high frequency circuits
- Uninterruptible power supply

100% UIS TESTED!

100% ΔV_d s TESTED!



Schematic diagram



Marking and pin assignment

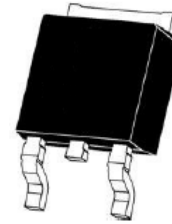

TO-252 -2L top view

Package Marking and Ordering Information

Device Marking	Device	Device Package	Reel Size	Tape width	Quantity
NCE0130KA	NCE0130KA	TO-252-2L	-	-	-

Absolute Maximum Ratings ($T_C=25^\circ C$ unless otherwise noted)

Symbol	Parameter	Limit	Unit
V_{DS}	Drain-Source Voltage	100	V
V_{GS}	Gate-Source Voltage	± 20	V
I_D	Drain Current-Continuous	30	A
$I_D(100^\circ C)$	Drain Current-Continuous($T_C=100^\circ C$)	21	A
I_{DM}	Pulsed Drain Current	70	A
P_D	Maximum Power Dissipation	85	W
	Derating factor	0.57	W/ $^\circ C$
E_{AS}	Single pulse avalanche energy ^(Note 5)	256	mJ
T_J, T_{STG}	Operating Junction and Storage Temperature Range	-55 To 175	$^\circ C$

Thermal Characteristic

$R_{\theta JC}$	Thermal Resistance, Junction-to-Case ^(Note 2)	1.8	$^{\circ}C/W$
-----------------	--	-----	---------------

Electrical Characteristics ($T_C=25^{\circ}C$ unless otherwise noted)

Symbol	Parameter	Condition	Min	Typ	Max	Unit
Off Characteristics						
BV_{DSS}	Drain-Source Breakdown Voltage	$V_{GS}=0V, I_D=250\mu A$	100	115	-	V
I_{DSS}	Zero Gate Voltage Drain Current	$V_{DS}=100V, V_{GS}=0V$	-	-	1	μA
I_{GSS}	Gate-Body Leakage Current	$V_{GS}=\pm 20V, V_{DS}=0V$	-	-	± 100	nA
On Characteristics ^(Note 3)						
$V_{GS(th)}$	Gate Threshold Voltage	$V_{DS}=V_{GS}, I_D=250\mu A$	1.3	1.9	2.5	V
$R_{DS(ON)}$	Drain-Source On-State Resistance	$V_{GS}=10V, I_D=10A$	-	27	31	m Ω
g_{FS}	Forward Transconductance	$V_{DS}=5V, I_D=10A$	-	15	-	S
Dynamic Characteristics ^(Note 4)						
C_{iss}	Input Capacitance	$V_{DS}=25V, V_{GS}=0V,$ $F=1.0MHz$	-	2000	-	PF
C_{oss}	Output Capacitance		-	300	-	PF
C_{rSS}	Reverse Transfer Capacitance		-	250	-	PF
Switching Characteristics ^(Note 4)						
$t_{d(on)}$	Turn-on Delay Time	$V_{DD}=50V, R_L=5\Omega$ $V_{GS}=10V, R_{GEN}=3\Omega$	-	7	-	nS
t_r	Turn-on Rise Time		-	7	-	nS
$t_{d(off)}$	Turn-Off Delay Time		-	29	-	nS
t_f	Turn-Off Fall Time		-	7	-	nS
Q_g	Total Gate Charge	$V_{DS}=50V, I_D=10A,$ $V_{GS}=10V$	-	39	-	nC
Q_{gs}	Gate-Source Charge		-	8	-	nC
Q_{gd}	Gate-Drain Charge		-	12	-	nC
Drain-Source Diode Characteristics						
V_{SD}	Diode Forward Voltage ^(Note 3)	$V_{GS}=0V, I_S=10A$	-	-	1.2	V
I_S	Diode Forward Current ^(Note 2)	-	-	-	30	A
t_{rr}	Reverse Recovery Time	$T_J = 25^{\circ}C, I_F = 10A$ $di/dt = 100A/\mu s$ ^(Note 3)	-	32	-	nS
Q_{rr}	Reverse Recovery Charge		-	53	-	nC
t_{on}	Forward Turn-On Time	Intrinsic turn-on time is negligible (turn-on is dominated by LS+LD)				

Notes:

1. Repetitive Rating: Pulse width limited by maximum junction temperature.
2. Surface Mounted on FR4 Board, $t \leq 10$ sec.
3. Pulse Test: Pulse Width $\leq 300\mu s$, Duty Cycle $\leq 2\%$.
4. Guaranteed by design, not subject to production
5. EAS Condition : $T_J=25^{\circ}C, V_{DD}=50V, V_G=10V, L=0.5mH, R_g=25\Omega, I_{AS}=32A$

Test Circuit

1) E_{AS} Test Circuit



2) Gate Charge Test Circuit



3) Switch Time Test Circuit



Typical Electrical and Thermal Characteristics (Curves)

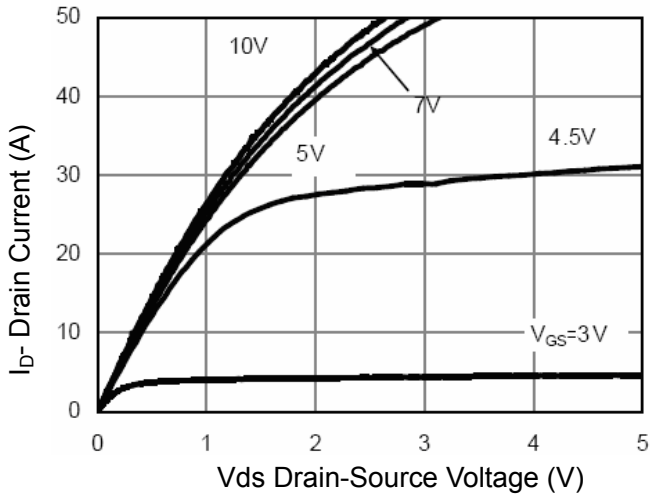

Figure 1 Output Characteristics

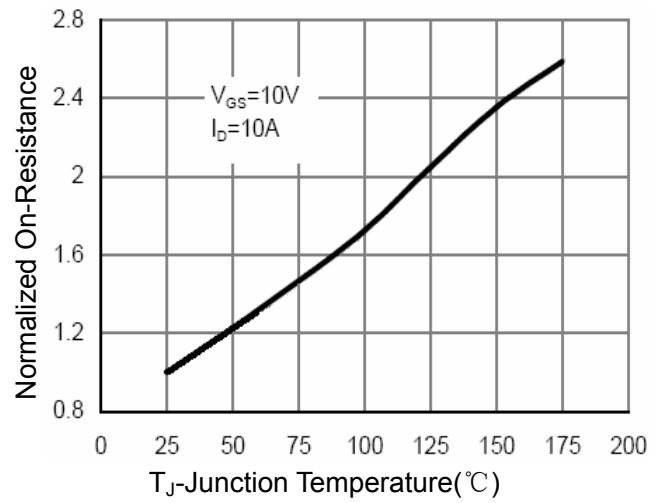

Figure 4 Rdson-Junction Temperature

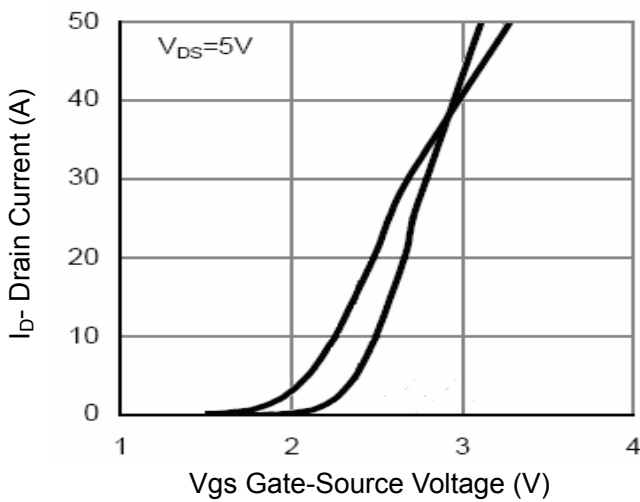

Figure 2 Transfer Characteristics

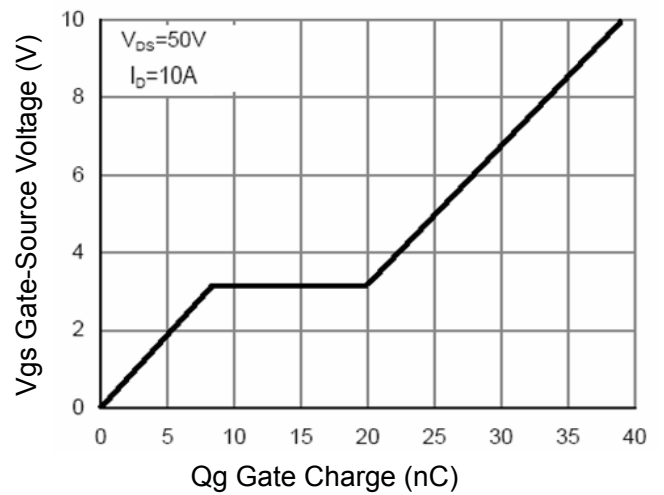

Figure 5 Gate Charge

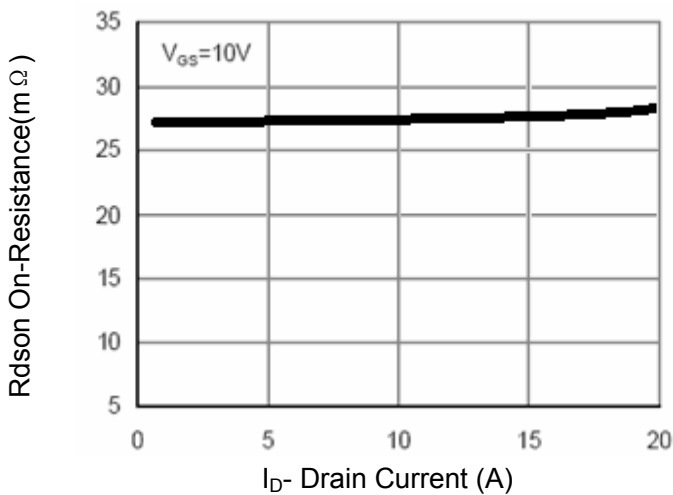

Figure 3 Rdson- Drain Current

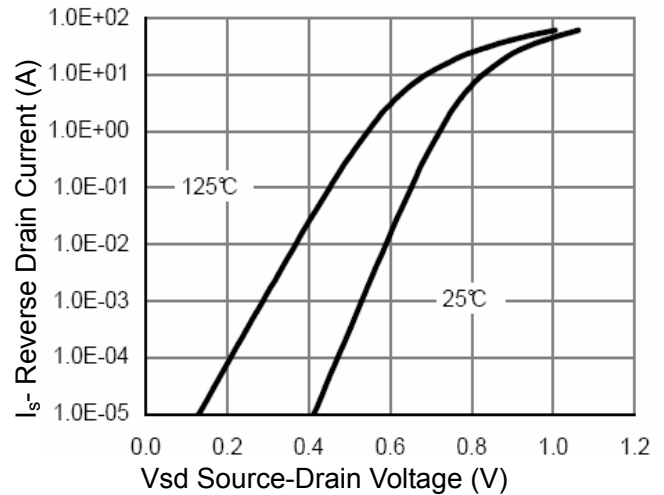

Figure 6 Source- Drain Diode Forward

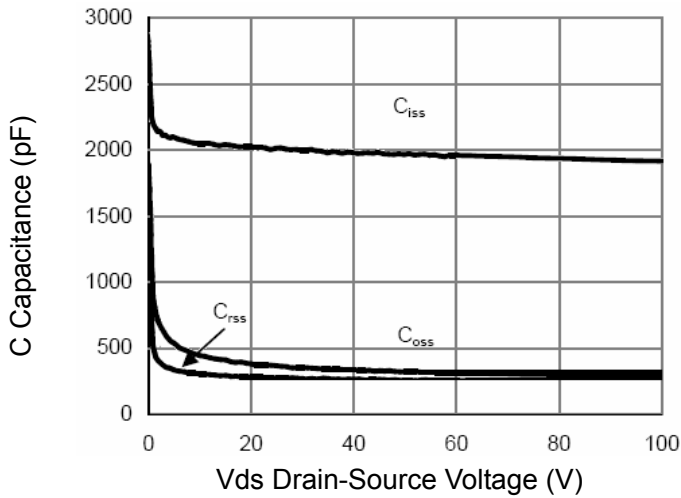

Figure 7 Capacitance vs Vds

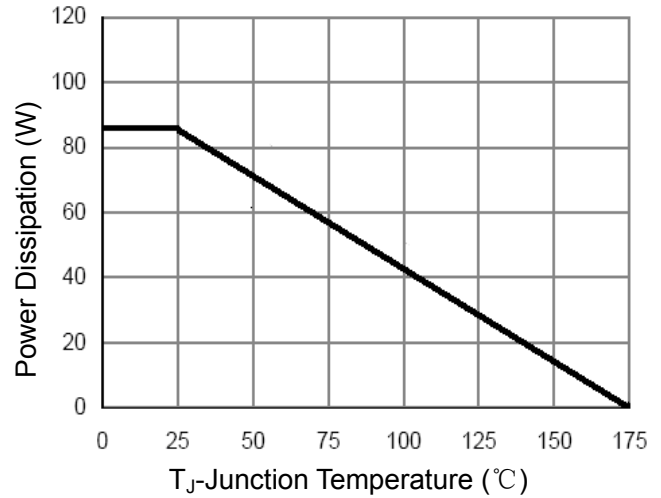

Figure 9 Power De-rating

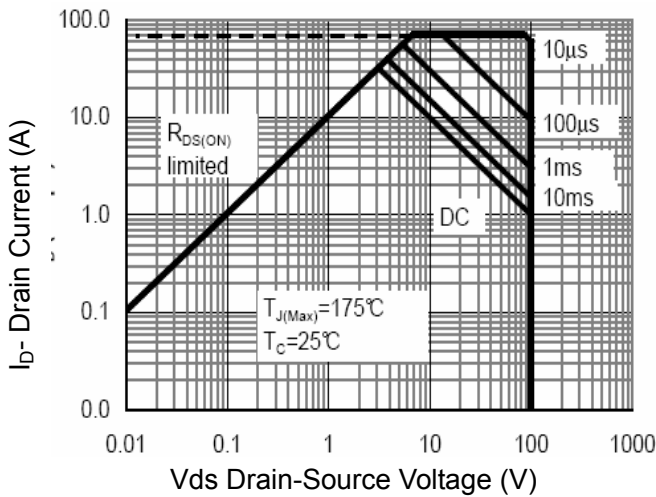

Figure 8 Safe Operation Area

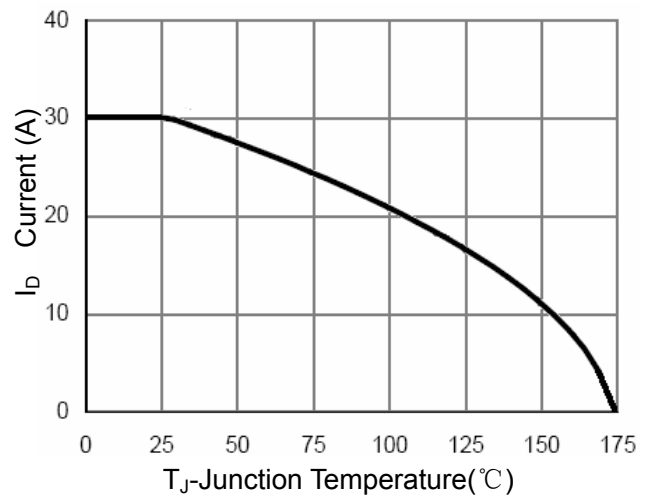

Figure 10 ID Current- Junction Temperature

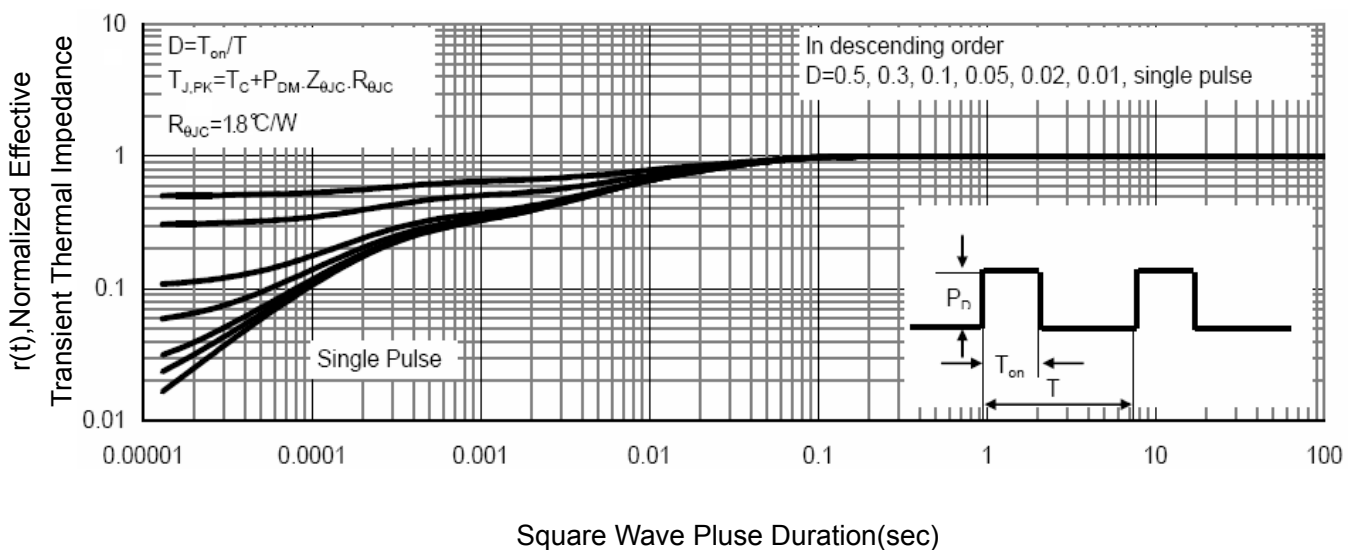
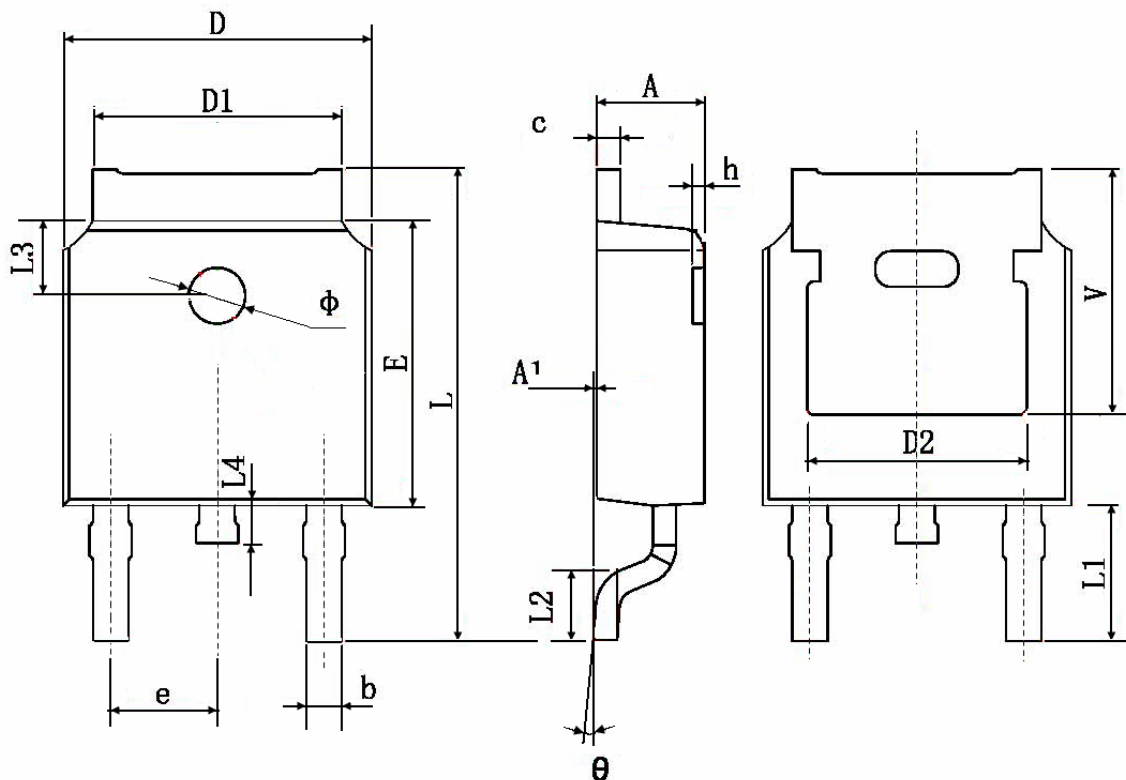

Figure 11 Normalized Maximum Transient Thermal Impedance

TO-252 Package Information

Symbol	Dimensions In Millimeters		Dimensions In Inches	
	Min.	Max.	Min.	Max.
A	2.200	2.400	0.087	0.094
A1	0.000	0.127	0.000	0.005
b	0.660	0.860	0.026	0.034
c	0.460	0.580	0.018	0.023
D	6.500	6.700	0.256	0.264
D1	5.100	5.460	0.201	0.215
D2	4.830 TYP.		0.190 TYP.	
E	6.000	6.200	0.236	0.244
e	2.186	2.386	0.086	0.094
L	9.800	10.400	0.386	0.409
L1	2.900 TYP.		0.114 TYP.	
L2	1.400	1.700	0.055	0.067
L3	1.600 TYP.		0.063 TYP.	
L4	0.600	1.000	0.024	0.039
Φ	1.100	1.300	0.043	0.051
θ	0°	8°	0°	8°
h	0.000	0.300	0.000	0.012
V	5.350 TYP.		0.211 TYP.	

Attention:

- Any and all NCE power products described or contained herein do not have specifications that can handle applications that require extremely high levels of reliability, such as life-support systems, aircraft's control systems, or other applications whose failure can be reasonably expected to result in serious physical and/or material damage. Consult with your NCE power representative nearest you before using any NCE power products described or contained herein in such applications.
- NCE power assumes no responsibility for equipment failures that result from using products at values that exceed, even momentarily, rated values (such as maximum ratings, operating condition ranges, or other parameters) listed in products specifications of any and all NCE power products described or contained herein.
- Specifications of any and all NCE power products described or contained herein stipulate the performance, characteristics, and functions of the described products in the independent state, and are not guarantees of the performance, characteristics, and functions of the described products as mounted in the customer's products or equipment. To verify symptoms and states that cannot be evaluated in an independent device, the customer should always evaluate and test devices mounted in the customer's products or equipment.
- NCE power Semiconductor CO.,LTD. strives to supply high-quality high-reliability products. However, any and all semiconductor products fail with some probability. It is possible that these probabilistic failures could give rise to accidents or events that could endanger human lives, that could give rise to smoke or fire, or that could cause damage to other property. When designing equipment, adopt safety measures so that these kinds of accidents or events cannot occur. Such measures include but are not limited to protective circuits and error prevention circuits for safe design, redundant design, and structural design.
- In the event that any or all NCE power products(including technical data, services) described or contained herein are controlled under any of applicable local export control laws and regulations, such products must not be exported without obtaining the export license from the authorities concerned in accordance with the above law.
- No part of this publication may be reproduced or transmitted in any form or by any means, electronic or mechanical, including photocopying and recording, or any information storage or retrieval system, or otherwise, without the prior written permission of NCE power Semiconductor CO.,LTD.
- Information (including circuit diagrams and circuit parameters) herein is for example only ; it is not guaranteed for volume production. NCE power believes information herein is accurate and reliable, but no guarantees are made or implied regarding its use or any infringements of intellectual property rights or other rights of third parties.
- Any and all information described or contained herein are subject to change without notice due to product/technology improvement, etc. When designing equipment, refer to the "Delivery Specification" for the NCE power product that you intend to use.
- This catalog provides information as of Sep.2010. Specifications and information herein are subject to change without notice.