

Advanced Secondary Side LLC Resonant Converter Controller with Synchronous Rectifier Control NCP4390

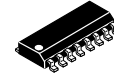

SOIC-16
 CASE 751B-05

MARKING DIAGRAM

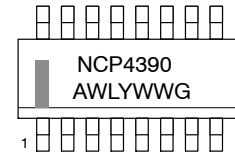

NCP4390	= Specific Device Code
A	= Assembly Location
L	= Wafer Lot
Y	= Year
WW	= Work Week
G	= Pb-Free Package

The NCP4390 is an advanced Pulse Frequency Modulated (PFM) controller for LLC resonant converters with Synchronous Rectification (SR) that offers best in class efficiency for isolated DC/DC converters. It employs a current mode control technique based on a charge control, where the triangular waveform from the oscillator is combined with the integrated switch current information to determine the switching frequency. This provides a better control-to-output transfer function of the power stage simplifying the feedback loop design while allowing true input power limit capability. Closed-loop soft-start prevents saturation of the error amplifier and allows monotonic rising of the output voltage regardless of load condition. A dual edge tracking adaptive dead time control minimizes the body diode conduction time thus maximizing efficiency.

Features

- Secondary Side PFM Controller for LLC Resonant Converter with Synchronous Rectifier Control
- Charge Current Control for Better Transient Response and Easy Feedback Loop Design
- Adaptive Synchronous Rectification Control with Dual Edge Tracking
- Closed Loop Soft-Start for Monotonic Rising Output
- Wide Operating Frequency (39 kHz ~ 690 kHz)
- Green Functions to Improve Light-Load Efficiency
 - ◆ Symmetric PWM Control at Light-Load to Limit the Switching Frequency while Reducing Switching Losses
 - ◆ Disabling SR at Light-Load Condition
- Protection Functions with Auto-Restart
 - ◆ Over-Current Protection (OCP)
 - ◆ Output Short Protection (OSP)
 - ◆ NON Zero-Voltage Switching Prevention (NVS) by Compensation Cutback (Frequency Shift)
 - ◆ Power Limit by Compensation Cutback (Frequency Shift)
 - ◆ Overload Protection (OLP) with Programmable Shutdown Delay Time
- Programmable Dead Times for Primary Side Switches and Secondary Side Synchronous Rectifiers
- V_{DD} Under-Voltage Lockout (UVLO)
- Wide Operating Temperature Range -40°C to +125°C
- This Device is Pb-Free, Halogen Free/BFR Free and is RoHS Compliant

Applications

- Automotive On Board Charger
- Intelligent 100 W-2 kW+ Off-Line & Industrial Power Supplies

PIN CONNECTIONS

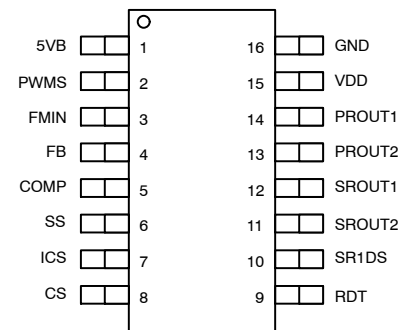

ORDERING INFORMATION

See detailed ordering and shipping information on page 3 of this data sheet.

NCP4390

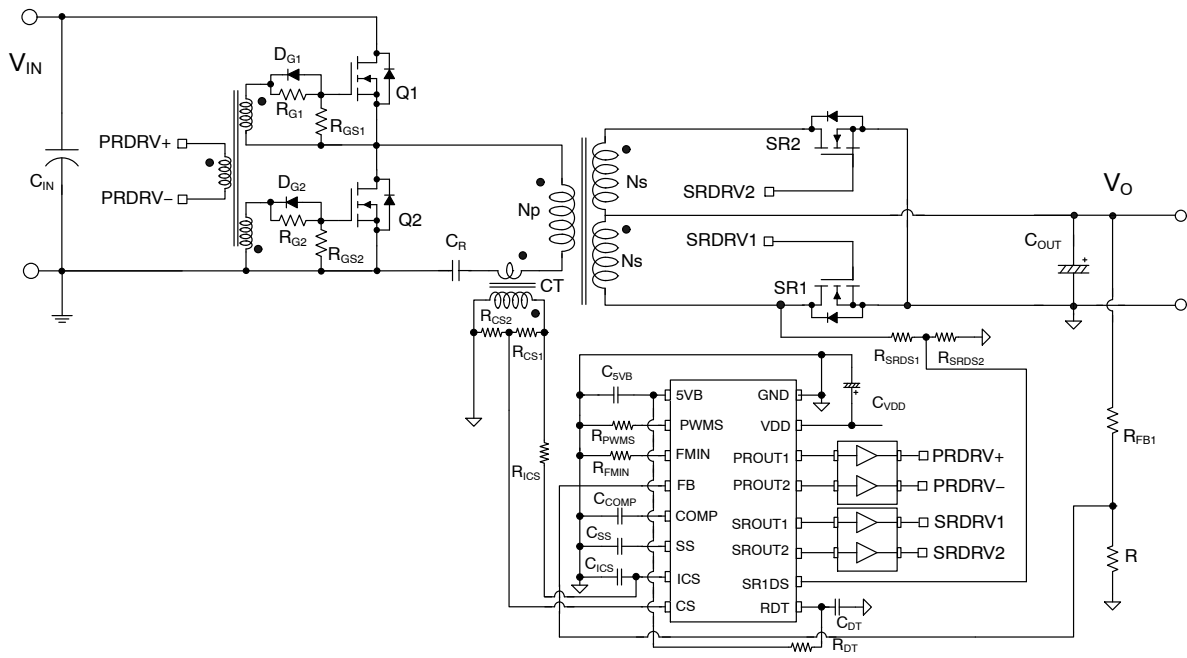

Figure 1. Typical Application Schematic of NCP4390

Block Diagram

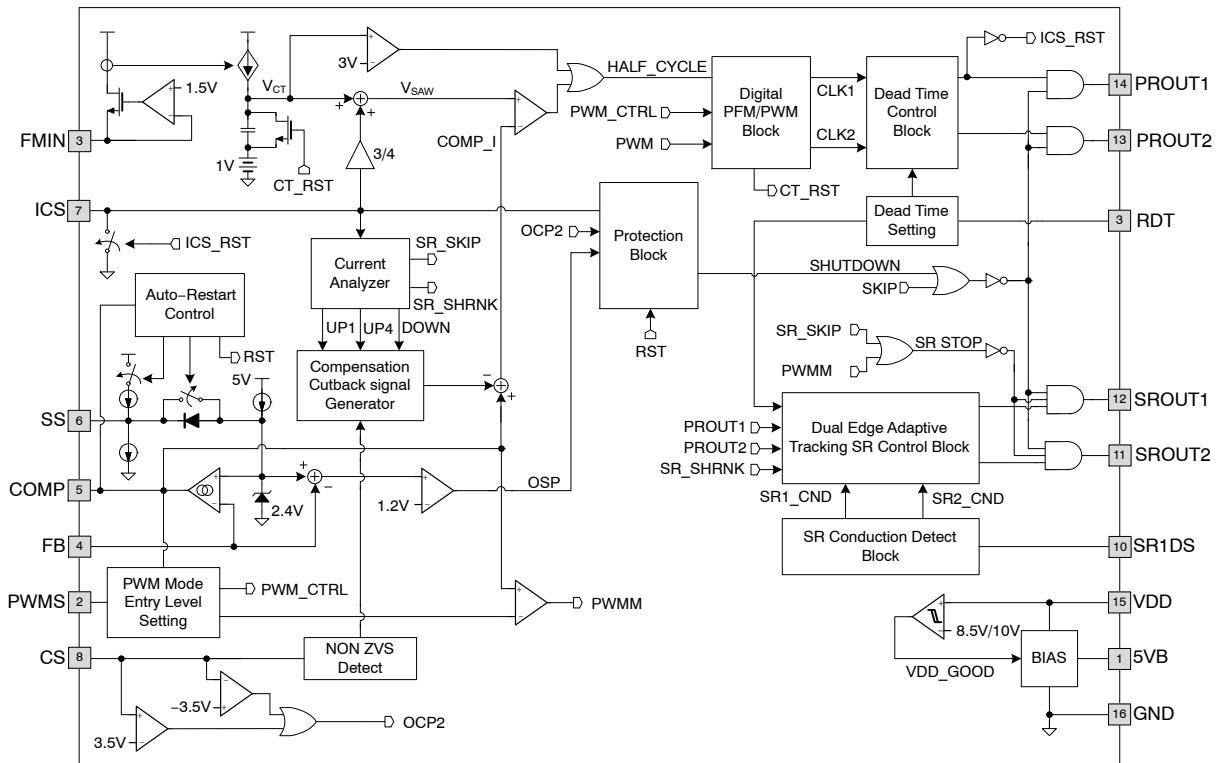

Figure 2. Internal Block Diagram of NCP4390

NCP4390

PIN DESCRIPTION

Pin Number	Pin Name	Description
1	5VB	5 V REF
2	PWMS	PWM mode entry level setting.
3	FMIN	Minimum frequency setting pin.
4	FB	Output voltage sensing for feedback control.
5	COMP	Output of error amplifier.
6	SS	Soft-start time programming pin.
7	ICS	Current information integration pin for current mode control.
8	CS	Current sensing for over current protection.
9	RDT	Dead time programming pin for the primary side switches and secondary side SR switches.
10	SR1DS	SR1 Drain-to-source voltage detection.
11	SROUT2	Gate drive output for the secondary side SR MOSFET 2.
12	SROUT1	Gate drive output for the secondary side SR MOSFET 1.
13	PROUT2	Gate drive output 2 for the primary side switch.
14	PROUT1	Gate drive output 1 for the primary side switch.
15	VDD	IC Supply voltage.
16	GND	Ground.

ORDERING AND SHIPPING INFORMATION

Ordering Code	Device Marking	Package	Shipping [†]
NCP4390DR2G	NCP4390	SOIC-16	Tape & Reel

[†]For information on tape and reel specifications, including part orientation and tape sizes, please refer to our Tape and Reel Packaging Specifications Brochure, BRD8011/D.

NCP4390

MAXIMUM RATINGS

Symbol	Parameter		Min	Max	Unit
V _{DD}	VDD Pin Supply Voltage to GND		-0.3	20.0	V
V _{5VB}	5VB Pin Voltage		-0.3	5.5	V
V _{PWMS}	PWMS Pin Voltage		-0.3	5.0	V
V _{FMIN}	FMIN Pin Voltage		-0.3	5.0	V
V _{FB}	FB Pin Voltage		-0.3	5.0	V
V _{COMP}	COMP Pin Voltage		-0.3	5.0	V
V _{SS}	SS Pin Voltage		-0.3	5.0	V
V _{ICS}	ICS Pin Voltage		-0.5	5.0	V
V _{CS}	CS Pin Voltage		-5.0	5.0	V
V _{RDT}	RDT Pin Voltage		-0.3	5.0	V
V _{SR1DS}	SR1DS Pin Voltage		-0.3	5.0	V
V _{PROUT1}	PROUT1 Pin Voltage		-0.3	V _{DD}	V
V _{PROUT2}	PROUT2 Pin Voltage		-0.3	V _{DD}	V
V _{SROUT1}	SROUT1 Pin Voltage		-0.3	V _{DD}	V
V _{SROUT2}	SROUT2 Pin Voltage		-0.3	V _{DD}	V
T _J	Junction Temperature		-40	150	°C
T _L	Lead Soldering Temperature (10 Seconds)			260	°C
T _{STG}	Storage Temperature		-65	150	°C
ESD	Electrostatic Discharge Capability	Human body Model, ANSI / ESDA / JEDEC JS-001-2012		2	kV
		Charged Device Model, JESD22-C101		1	kV

Stresses exceeding those listed in the Maximum Ratings table may damage the device. If any of these limits are exceeded, device functionality should not be assumed, damage may occur and reliability may be affected.
All voltage values are with respect to the GND pin.

THERMAL CHARACTERISTICS

Symbol	Rating	Value	Unit
R _{θJA}	Junction-to-Ambient Thermal Characteristics	115	°C/W

RECOMMENDED OPERATING CONDITIONS

Symbol	Parameter	Min.	Max.	Unit
V _{DD}	VDD Pin Supply Voltage to GND	0	18	V
V _{5VB}	5VB Pin Voltage	0	5	V
V _{INS}	Signal Input Voltage	0	5	V
T _J	Operating Junction Temperature	-40	+125	°C

Functional operation above the stresses listed in the Recommended Operating Ranges is not implied. Extended exposure to stresses beyond the Recommended Operating Ranges limits may affect device reliability.
Allowable operating ambient temperature can be limited by the power dissipation of NCP4390.

NCP4390

ELECTRICAL CHARACTERISTICS ($V_{DD} = 12\text{ V}$, $C_{5VB} = 33\text{ nF}$ and $T_J = -40^\circ\text{C}$ to 125°C unless otherwise specified)

Symbol	Parameter	Conditions	Min	Typ	Max	Unit
SUPPLY VOLTAGE (VDD PIN)						
$I_{STARTUP}$	Startup Supply Current	$V_{DD} = 9\text{ V}$		80	115	μA
I_{DD}	Operating Current	$V_{COMP} = 0.1\text{ V}$, $V_{FB} = 3\text{ V}$, $V_{SS} = 0\text{ V}$		2.8		mA
I_{DD_DYM1}	Dynamic Operating Current	$f_{SW} = 100\text{ kHz}$; $C_L = 1\text{ nF}$, with PR Operation Only		10		mA
I_{DD_DYM2}	Dynamic Operating Current	$f_{SW} = 100\text{ kHz}$; $C_L = 1\text{ nF}$, with PR & SR Operation		13		mA
V_{DD_ON}	VDD ON Voltage (VDD Rising)		9	10	11	V
V_{DD_OFF}	VDD OFF Voltage (VDD Falling)			8.6		V
V_{DD_HYS}	UVLO Hysteresis		0.9	1.4	1.9	V
REFERENCE VOLTAGE						
V_{5VB}	5 V Reference	$T_J = 25^\circ\text{C}$	4.99	5.05	5.11	V
		$-40^\circ\text{C} < T_J < 125^\circ\text{C}$	4.90	5.05	5.20	V
ERROR AMPLIFIER (COMP PIN)						
V_{SS_CLMP}	Voltage Feedback Reference	$T_J = 25^\circ\text{C}$	2.37	2.40	2.43	V
		$-40^\circ\text{C} < T_J < 125^\circ\text{C}$	2.34	2.40	2.46	V
g_m	Error Amplifier Gain Transconductance			300		μmho
I_{COMP1}	Error Amplifier Maximum Output Current (Sourcing)	$V_{FB} = 1.8\text{ V}$, $V_{COMP} = 2.5\text{ V}$	65	90	115	μA
I_{COMP2}	Error Amplifier Maximum Output Current (Sinking)	$V_{FB} = 3.0\text{ V}$, $V_{COMP} = 2.5\text{ V}$	65	90	115	μA
V_{COMP_CLMP1}	Error Amplifier Output High Clamping Voltage	$V_{FB} = 1.8\text{ V}$	4.2	4.4	4.6	V
V_{COMP_PWM}	V_{COMP} Internal Clamping Voltage for PWM Operation	$RPWM = 130\text{ k}$	1.26	1.41	1.56	V
		$RPWM = 82\text{ k}$	1.4	1.6	1.8	V
V_{PWMS}	PWMS Pin Voltage	$RPWM = 82\text{ k}$	1.9	2.0	2.1	V
V_{COMP_SKP}	V_{COMP} Threshold for Entering Skip Cycle Operation		1.15	1.25	1.35	V
$V_{COMP_SKP_HYS}$	V_{COMP} Threshold Hysteresis for Entering Skip Cycle Operation			50		mV
DEAD TIME (DT PIN)						
I_{DT}	Dead-Time Programming Current	$V_{RDT} = 1.2\text{ V}$	140	150	160	μA
V_{THDT1}	First Threshold for Dead-Time Detection		0.9	1.0	1.1	V
V_{THDT2}	Second Threshold for Dead-Time Detection		2.8	3.0	3.2	V
V_{RDT_ON}	V_{RDT_ON} Voltage (V_{RDT} Rising)		1.2	1.4	1.6	V
SOFT-START (SS PIN)						
I_{SS_T}	Total Soft-Start Current (Including I_{SS_UP})	$V_{SS} = 1\text{ V}$	32	40	52	μA
V_{OLP}	Overload Protection Threshold		3.45	3.60	3.75	V
I_{SS_UP}	Soft-Start Capacitor Charge Current for Delayed Shutdown	$V_{SS} = 3\text{ V}$	8.2	10.5	12.8	μA

NCP4390

ELECTRICAL CHARACTERISTICS ($V_{DD} = 12\text{ V}$, $C_{5VB} = 33\text{ nF}$ and $T_J = -40^\circ\text{C}$ to 125°C unless otherwise specified)

Symbol	Parameter	Conditions	Min	Typ	Max	Unit
--------	-----------	------------	-----	-----	-----	------

SOFT-START (SS PIN)

$I_{SS.DN}$	Soft-Start Capacitor Discharge Current	$V_{SS} = 3\text{ V}$	8.2	10.5	12.8	μA
$V_{SS.MAX}$	SS Capacitor Maximum Charging Voltage		4.5	4.7	4.9	V
$V_{SS.INIT}$	SS Capacitor Initialization Voltage		0.01	0.10	0.20	V

FEEDBACK (FB PIN)

$V_{FB.OVP1}$	VFB Threshold for Entering Skip Cycle Operation	$V_{COMP} = 3\text{ V}$	2.53	2.65	2.77	V
$V_{FB.OVP2}$	VFB Threshold for Exiting Skip Cycle Operation	$V_{COMP} = 3\text{ V}$	2.18	2.30	2.42	V
$V_{ERR.OSP}$	Error Voltage to Enable Output Short Protection (OSP)	$V_{SS} = 2.4\text{ V}$	1.0	1.2	1.4	V

OSCILLATOR

V_{FMIN}	FMIN Pin Voltage	$R_{FIMN} = 10\text{ k}\Omega$,	1.4	1.5	1.6	V
f_{OSC}	PROUT Switching Frequency	$R_{MINF} = 10\text{ k}\Omega$, $V_{CS} = 1\text{ V}$ $V_{COMP} = 4.0\text{ V}$, $V_{ICS} = 0\text{ V}$	95	100	105	kHz
$f_{OSC.min}$	Minimum PROUT Switching Frequency (40 MHz/1024)	$R_{MINF} = 40\text{ k}\Omega$, $V_{CS} = 1\text{ V}$ $V_{COMP} = 4.0\text{ V}$, $V_{ICS} = 0\text{ V}$	36	39	42	kHz
$f_{OSC.max}$	Maximum PROUT Switching Frequency (40 MHz/58)	$R_{MINF} = 2\text{ k}\Omega$, $V_{CS} = 1\text{ V}$ $V_{COMP} = 2.0\text{ V}$, $V_{ICS} = 0\text{ V}$	635	690	735	kHz
D	PROUT Duty Cycle in PFM Mode	$R_{MINF} = 20\text{ k}\Omega$, $V_{CS} = 1\text{ V}$ $V_{COMP} = 4.0\text{ V}$		50		%

INTEGRATED CURRENT SENSING (ICS PIN)

$V_{ICS.CLMP}$	ICS Pin Signal Clamping Voltage	$I_{CS} = 400\text{ }\mu\text{A}$		10	50	mV
$R_{DS-ON.ICS}$	ICS Pin Clamping MOSFET R_{DS-ON}	$I_{CS} = 1.5\text{ mA}$		20		Ω
V_{TH1}	SR_SHRINK Enable Threshold	$V_{COMP} = 2.4\text{ V}$	0.15	0.20	0.25	V
$V_{TH1.HYS}$	SR_SHRINK Disable Hysteresis	$V_{COMP} = 2.4\text{ V}$		50		mV
V_{TH2}	SR_SKIP Disable Threshold	$V_{COMP} = 2.4\text{ V}$	0.10	0.15	0.20	V
V_{TH3}	SR_SKIP Enable Threshold	$V_{COMP} = 2.4\text{ V}$	0.025	0.075	0.125	V
V_{OCL1}	Over-Current Limit First Threshold	$V_{COMP} = 2.4\text{ V}$	1.12	1.20	1.28	V
V_{OCL2}	Over-Current Limit Second Threshold	$V_{COMP} = 2.4\text{ V}$	1.34	1.45	1.56	V
$V_{OCL1.BR}$	Over-Current Limit First Threshold in Deep Below Resonance Operation	$V_{COMP} = 2.4\text{ V}$	1.34	1.45	1.56	V
$V_{OCL2.BR}$	Over-Current Limit Second Threshold in Deep Below Resonance Operation	$V_{COMP} = 2.4\text{ V}$	1.59	1.70	1.81	V
V_{OCP1}	Over-Current Protection Threshold	$V_{COMP} = 2.4\text{ V}$	1.77	1.90	2.03	V
$V_{OCP1.BR}$	Over-Current Protection Threshold	$V_{COMP} = 2.4\text{ V}$	2.02	2.15	2.28	V
$T_{OCP1.DLY}$	Debounce Time for Over-Current Protection 1			150		ns

NCP4390

ELECTRICAL CHARACTERISTICS ($V_{DD} = 12\text{ V}$, $C_{5VB} = 33\text{ nF}$ and $T_J = -40^\circ\text{C}$ to 125°C unless otherwise specified)

Symbol	Parameter	Conditions	Min	Typ	Max	Unit
--------	-----------	------------	-----	-----	-----	------

CURRENT SENSING (CS PIN)

V_{OCP2P}	Over-Current Protection Threshold		3.3	3.5	3.7	V
$T_{OCP2.DLY}$	Debounce Time for Over-Current Protection 2			150		ns
V_{OCP2N}	Over-Current Protection Threshold		-4.0	-3.5	-3.0	V
$V_{CS.NZVS}$	CS Signal Threshold for Non-ZVS Detection	$V_{COMP} = 3.5\text{ V}$	0.24	0.30	0.36	V
$V_{COMP.NZVS}$	COMP Threshold for Non-ZVS Detection	$V_{CS} = 0.1\text{ V}$	2.7	3.0	3.3	V

GATE DRIVE (PROUT1 AND PROUT2)

I_{SINK}	PROUT Sinking Current	$V_{PROUT1} \text{ \& } V_{PROUT2} = 6\text{ V}$		140		mA
I_{SOURCE}	PROUT Sourcing Current	$V_{PROUT1} \text{ \& } V_{PROUT2} = 6\text{ V}$		150		mA
$t_{PR.RISE}$	Rise Time	$V_{DD} = 12\text{ V}$, $C_L = 1\text{ nF}$, 10% to 90%		100		ns
$t_{PR.FALL}$	Fall Time	$V_{DD} = 12\text{ V}$, $C_L = 1\text{ nF}$, 90% to 10%		85		ns

SYNCHRONOUS RECTIFICATION (SR) CONTROL

TRC_SRC (Note 1)	Internal RC Time Constant SR Conduction Detection		50	100	150	ns
VSRCD.OFFSET1 (Note 1)	Internal Comparator Offset Rising Edge Detection		0.15	0.25	0.35	V
VSRCD.OFFSET2 (Note 1)	Internal Comparator Offset Falling Edge Detection		0.10	0.20	0.30	V
$V_{SRCD.LOW}$	SR Conduction Detect threshold		0.4	0.5	0.6	V
$T_{DLY.CMP.SR}$	SR Conduction Detect Comparator Delay			65		ns
$V_{FB.SR.ON}$	SR Enable FB Voltage		1.6	1.8	2.0	V
$V_{FB.SR.OFF}$	SR Disable FB Voltage		1.0	1.2	1.4	V

SR OUTPUT (SROUT1 AND SROUT2)

$I_{SR.SINK}$	PROUT Sinking Current	$V_{SROUT1} \text{ \& } V_{SROUT2} = 6\text{ V}$		140		mA
$I_{SR.SOURCE}$	PROUT Sourcing Current	$V_{SROUT1} \text{ \& } V_{SROUT2} = 6\text{ V}$		150		mA
$t_{SR.RISE}$	Rise Time	$V_{DD} = 12\text{ V}$, $C_L = 1\text{ nF}$, 10% to 90%		100		ns
$t_{SR.FALL}$	Fall Time	$V_{DD} = 12\text{ V}$, $C_L = 1\text{ nF}$, 90% to 10%		85		ns

Product parametric performance is indicated in the Electrical Characteristics for the listed test conditions, unless otherwise noted. Product performance may not be indicated by the Electrical Characteristics if operated under different conditions.

1. These parameters, although guaranteed by design, are not production tested.

TYPICAL PERFORMANCE CHARACTERISTICS

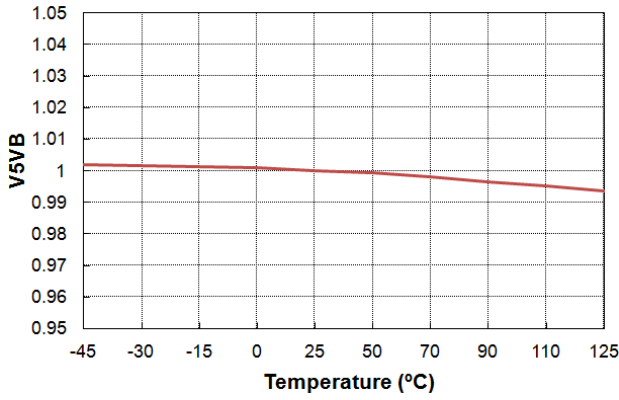

Figure 3. V_{5VB} vs. Temperature

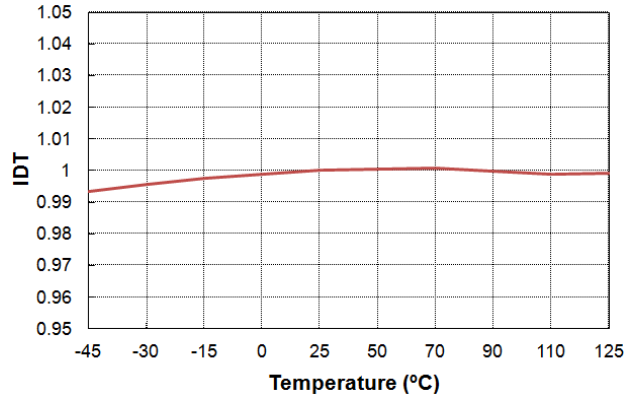

Figure 4. I_{DT} vs. Temperature

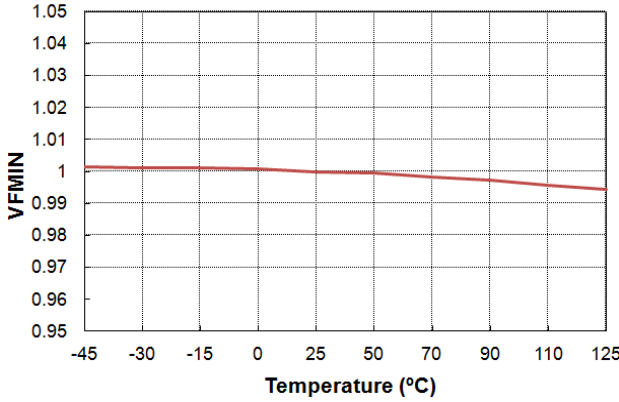

Figure 5. V_{FMIN} vs. Temperature

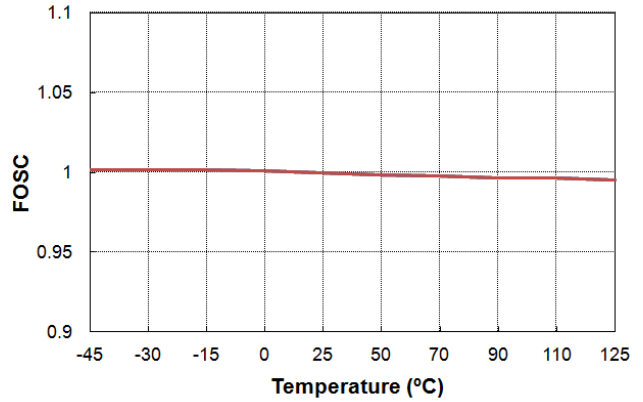

Figure 6. f_{OSC} vs. Temperature

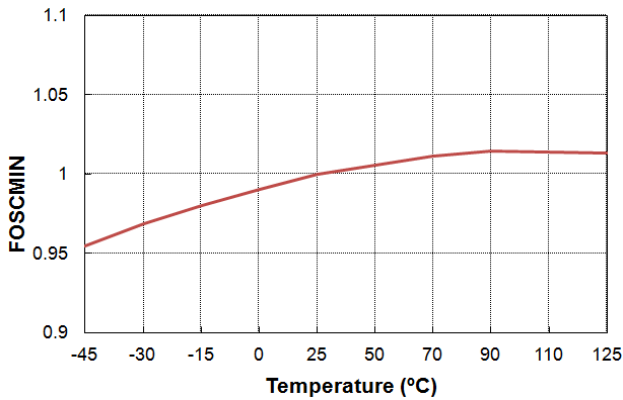

Figure 7. $f_{OSC.MIN}$ vs. Temperature

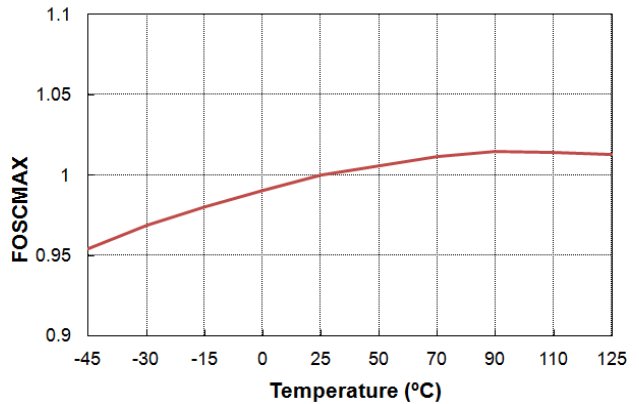

Figure 8. $f_{OSC.MAX}$ vs. Temperature

TYPICAL PERFORMANCE CHARACTERISTICS

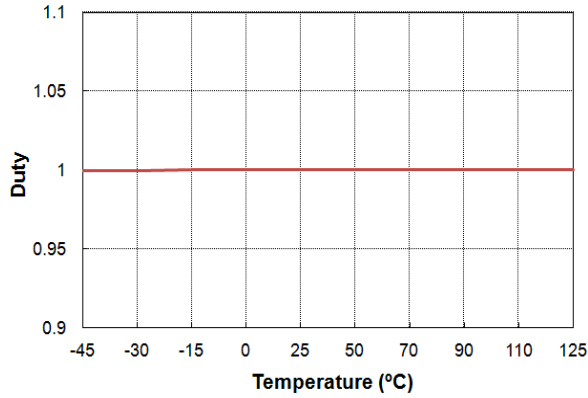

Figure 9. DUTY CYCLE vs. Temperature

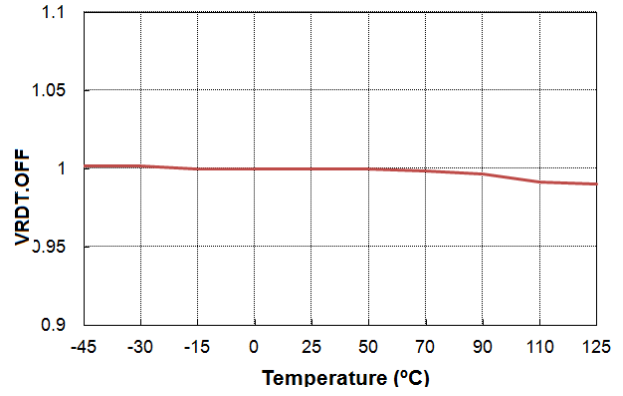

Figure 10. VRDT.OFF vs. Temperature

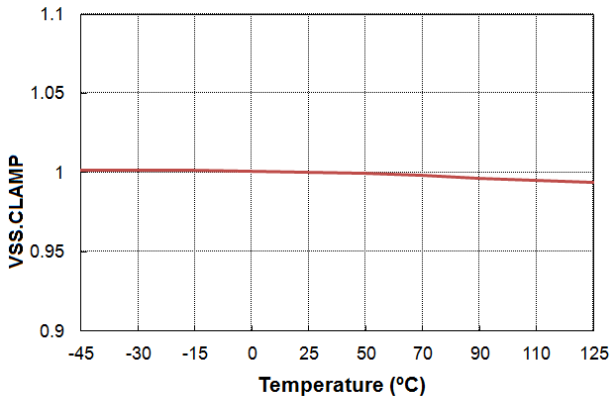

Figure 11. VSS.CLAMP vs. Temperature

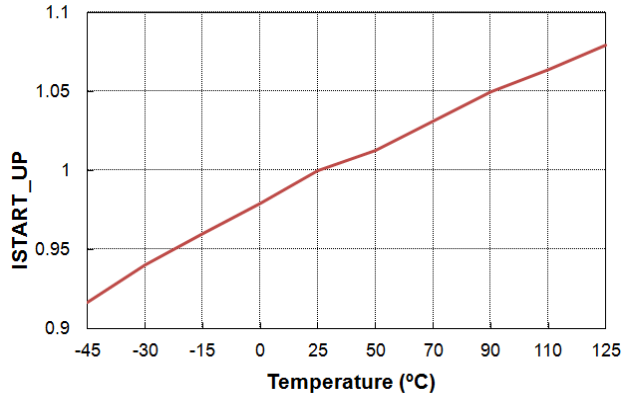

Figure 12. ISTARTUP vs. Temperature

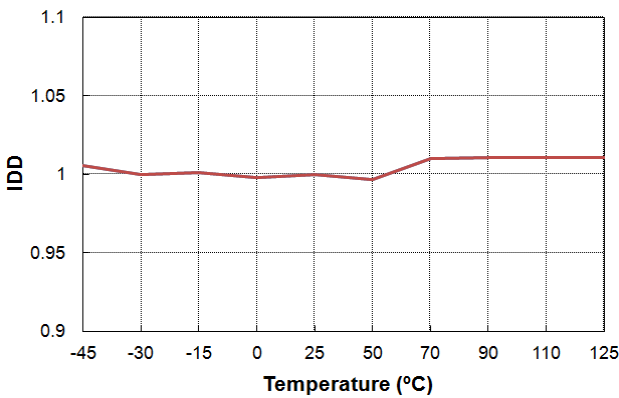

Figure 13. IDD vs. Temperature

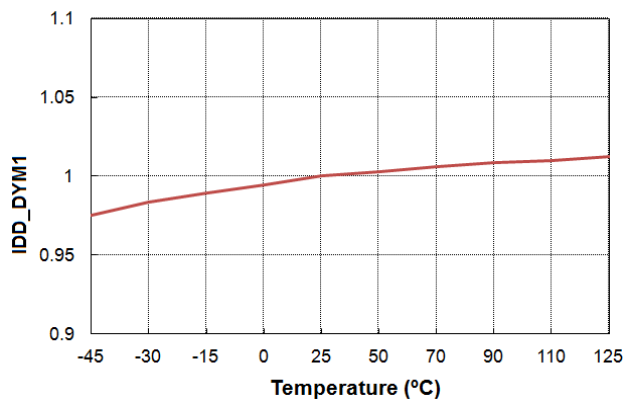

Figure 14. IDD_DYM1 vs. Temperature

TYPICAL PERFORMANCE CHARACTERISTICS

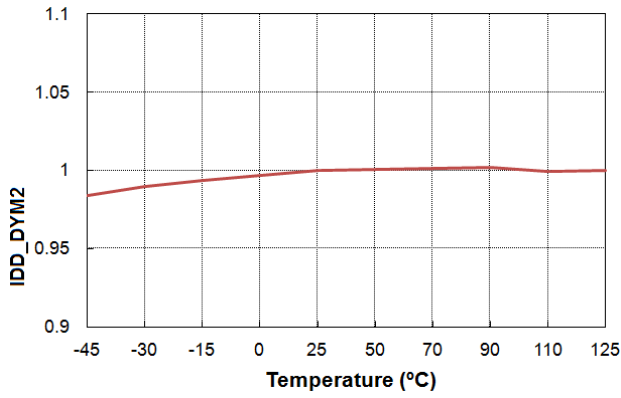

Figure 15. I_{DD_DYM2} vs. Temperature

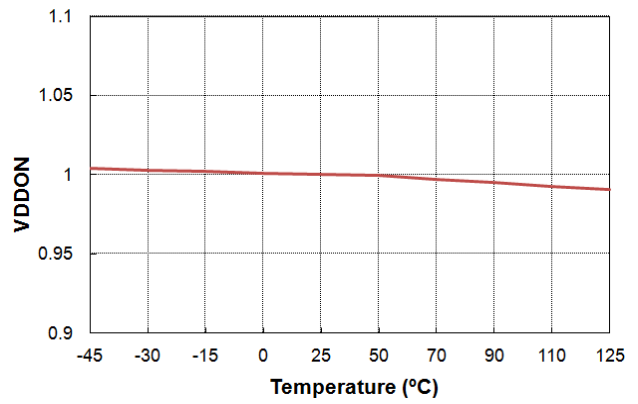

Figure 16. V_{DD_ON} vs. Temperature

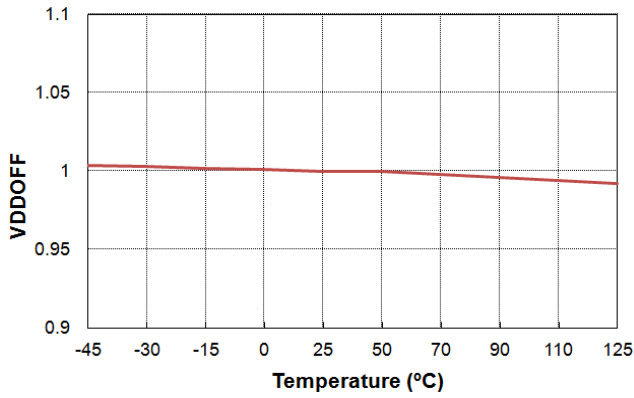

Figure 17. V_{DD_OFF} vs. Temperature

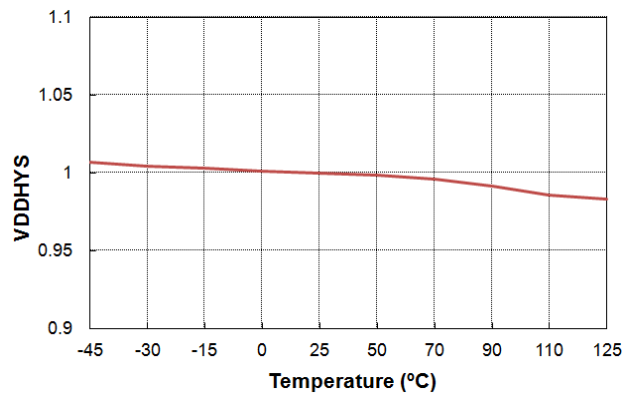

Figure 18. V_{DD_HYS} vs. Temperature

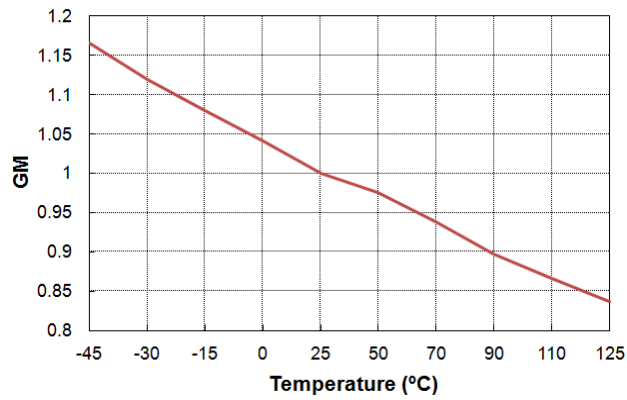

Figure 19. gm vs. Temperature

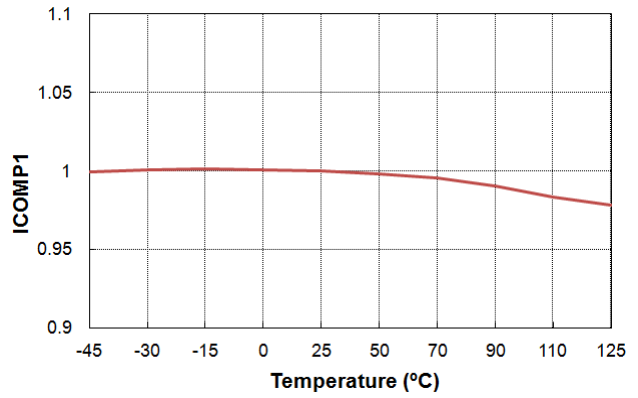

Figure 20. I_{COMP1} vs. Temperature

TYPICAL PERFORMANCE CHARACTERISTICS

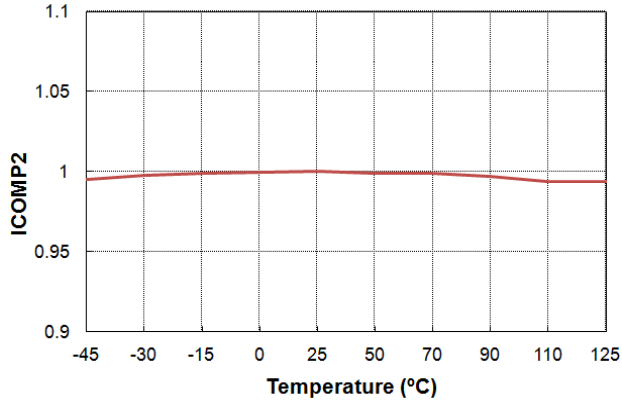

Figure 21. ICOMP2 vs. Temperature

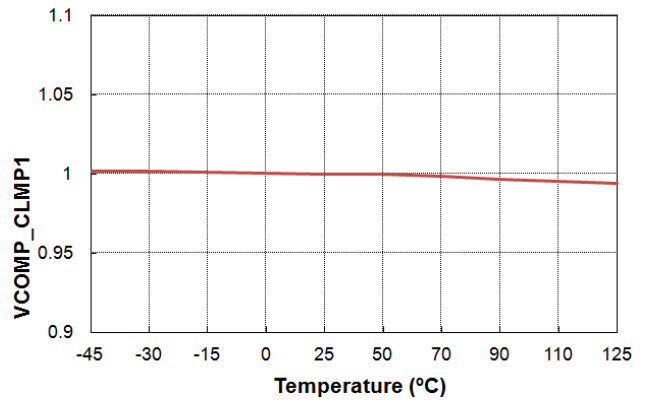

Figure 22. VCOMP.CLMP1 vs. Temperature

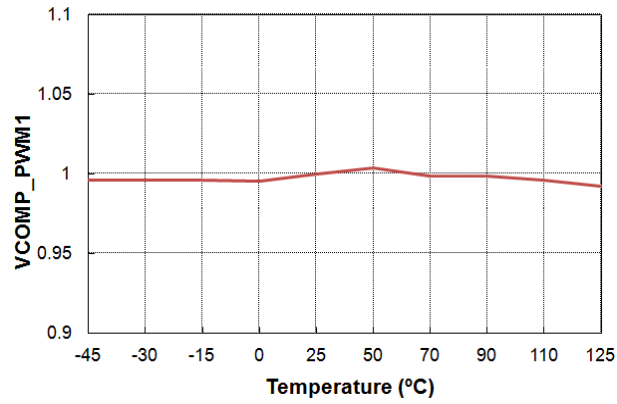

Figure 23. VCOMP.PWM vs. Temperature

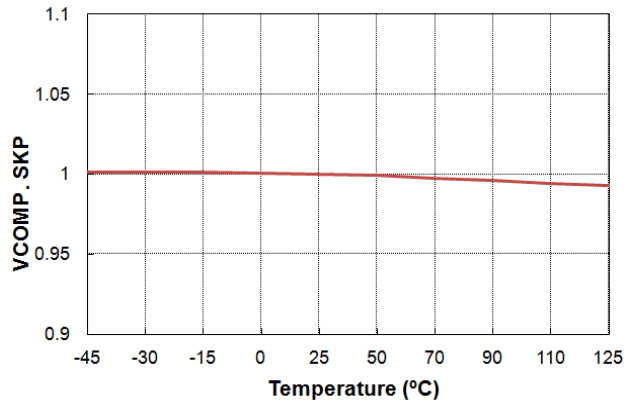

Figure 24. VCOMP.SKIP vs. Temperature

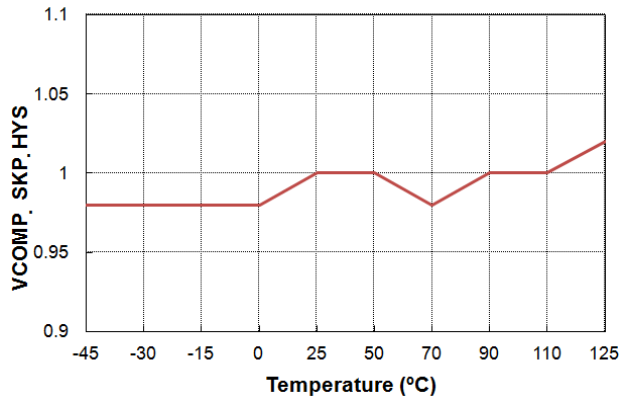

Figure 25. VCOMP.SKIP.HYS vs. Temperature

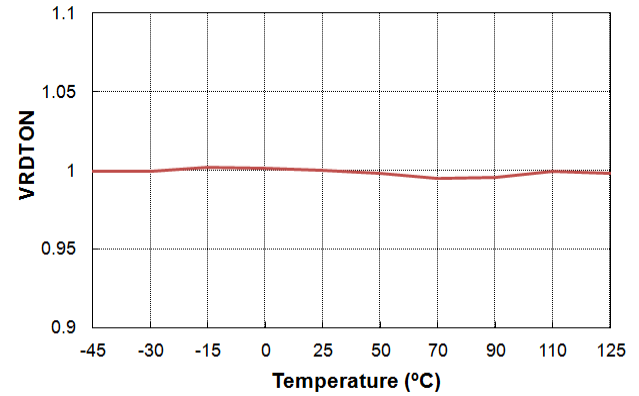

Figure 26. VRDT.ON vs. Temperature

TYPICAL PERFORMANCE CHARACTERISTICS

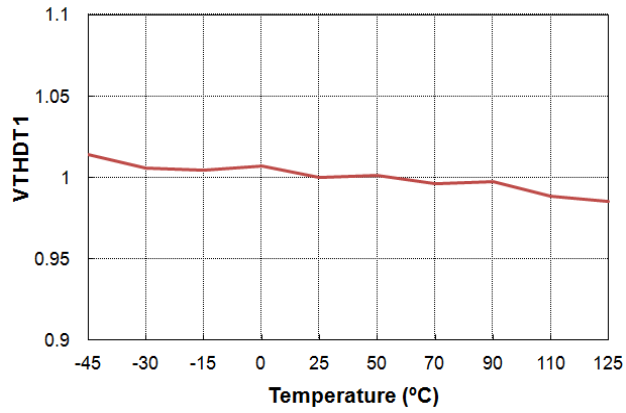

Figure 27. V_{THDT1} vs. Temperature

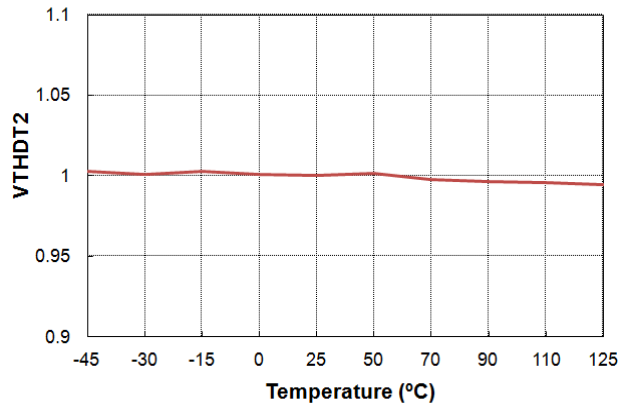

Figure 28. V_{THDT2} vs. Temperature

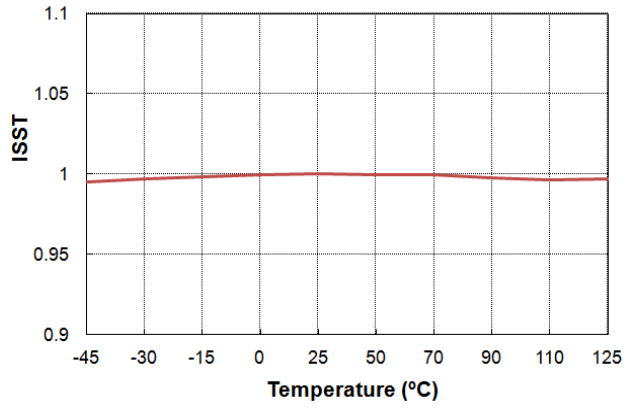

Figure 29. I_{SS,T} vs. Temperature

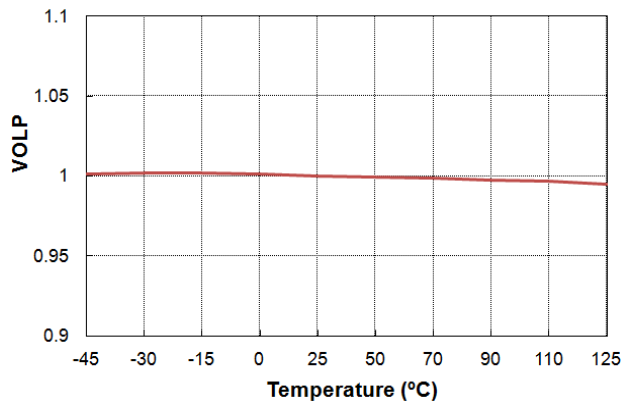

Figure 30. V_{OLP} vs. Temperature

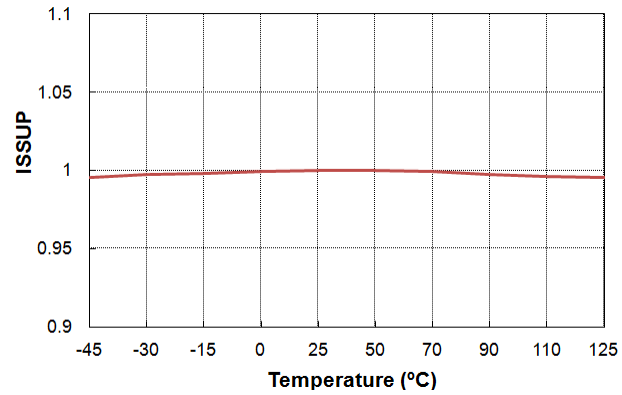

Figure 31. I_{SS,UP} vs. Temperature

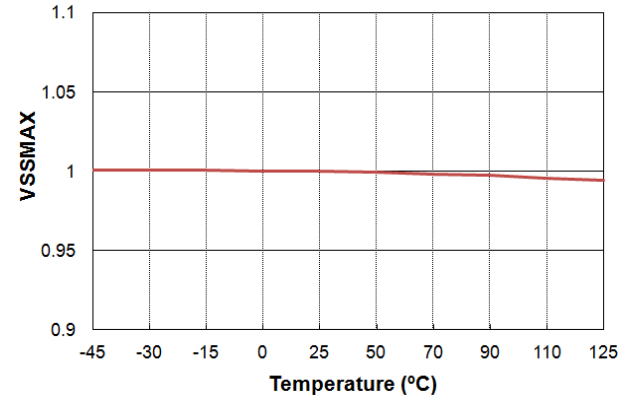

Figure 32. V_{SS,MAX} vs. Temperature

TYPICAL PERFORMANCE CHARACTERISTICS

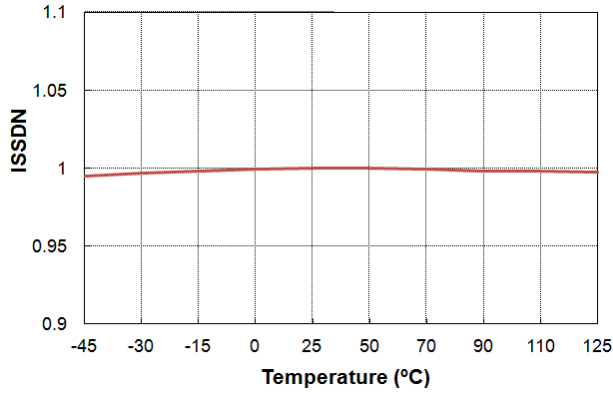

Figure 33. $I_{SS.DN}$ vs. Temperature

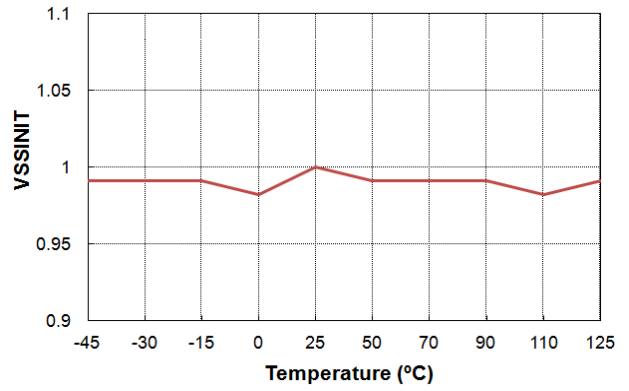

Figure 34. $V_{SS.INIT}$ vs. Temperature

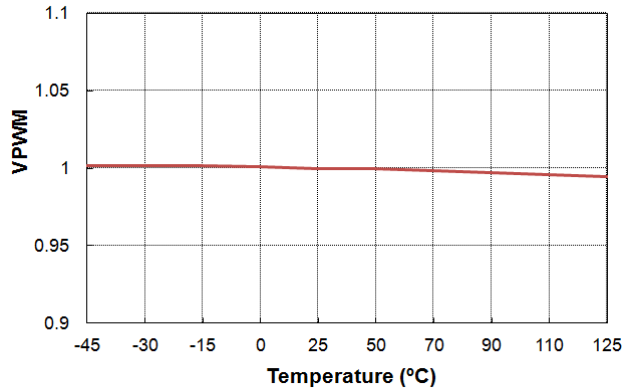

Figure 35. V_{PWMS} vs. Temperature

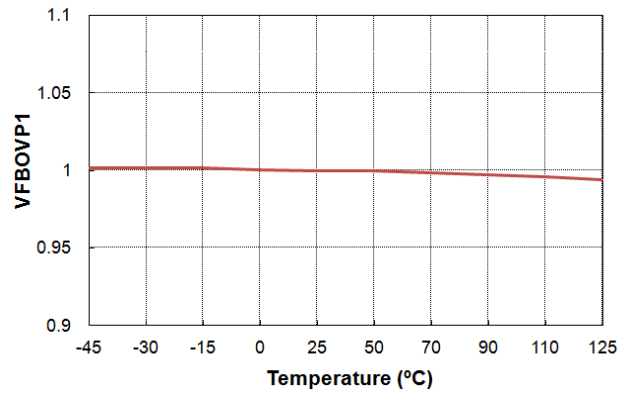

Figure 36. $V_{FB.OVP1}$ vs. Temperature

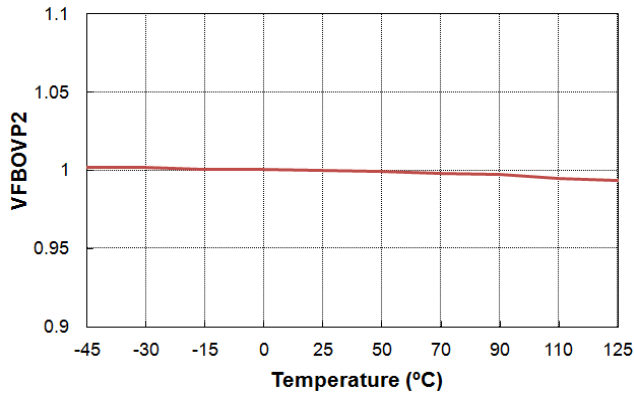

Figure 37. $V_{FB.OVP2}$ vs. Temperature

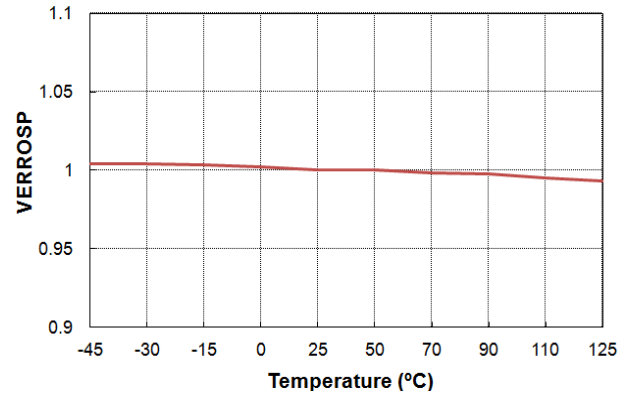

Figure 38. $V_{ERR.OSP}$ vs. Temperature

TYPICAL PERFORMANCE CHARACTERISTICS

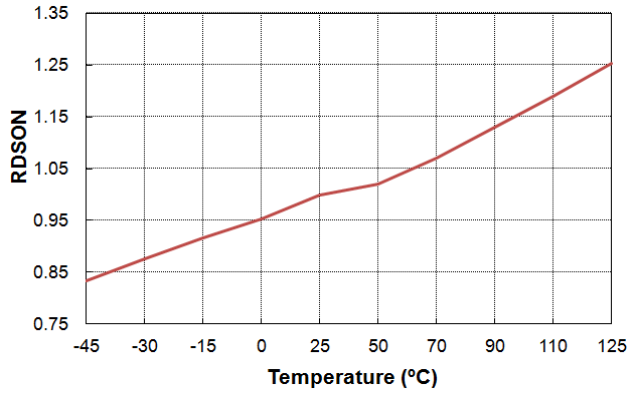

Figure 39. RDS-ON, ICS vs. Temperature

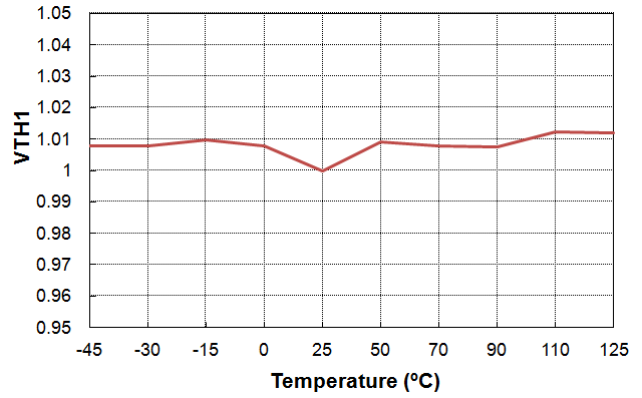

Figure 40. V_{TH1} vs. Temperature

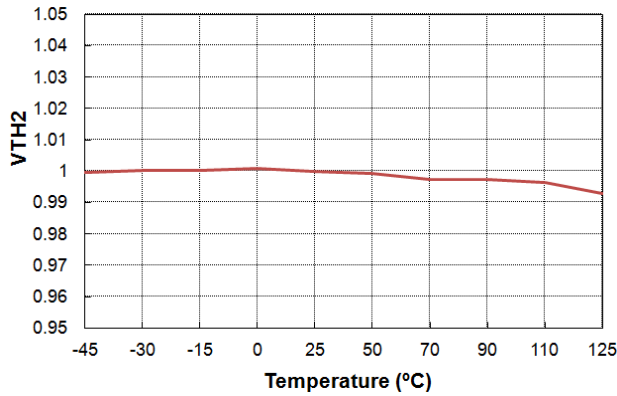

Figure 41. V_{TH1} vs. Temperature

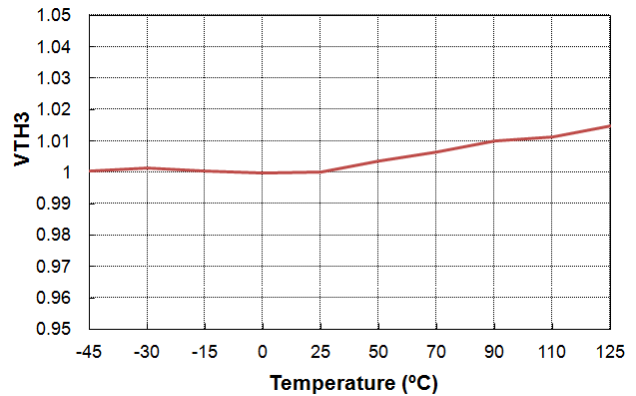

Figure 42. V_{TH3} vs. Temperature

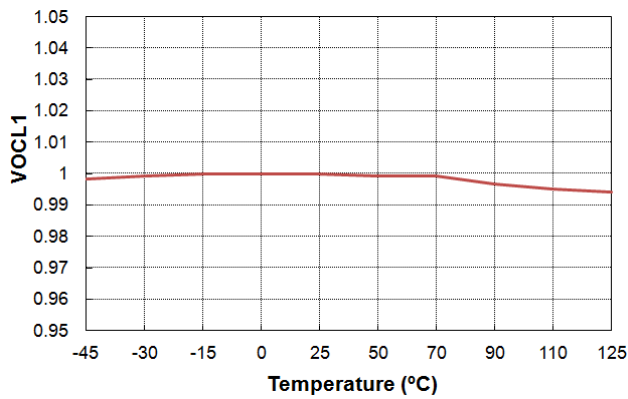

Figure 43. V_{OCL1} vs. Temperature

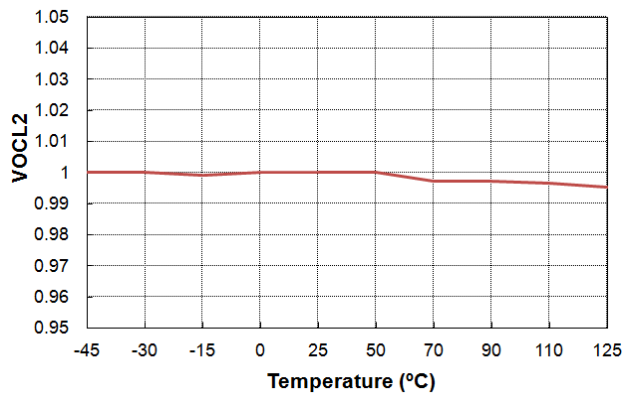

Figure 44. V_{OCL2} vs. Temperature

TYPICAL PERFORMANCE CHARACTERISTICS

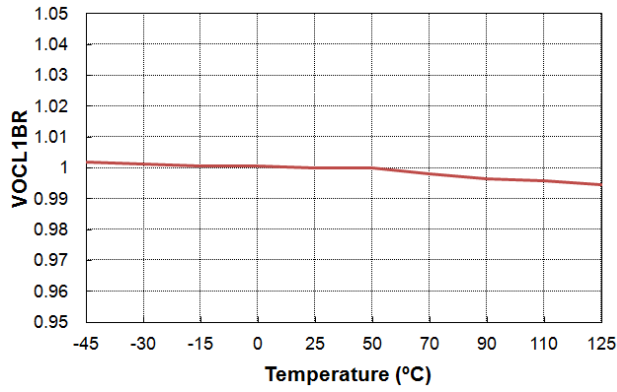

Figure 45. V_{OCL1BR} vs. Temperature

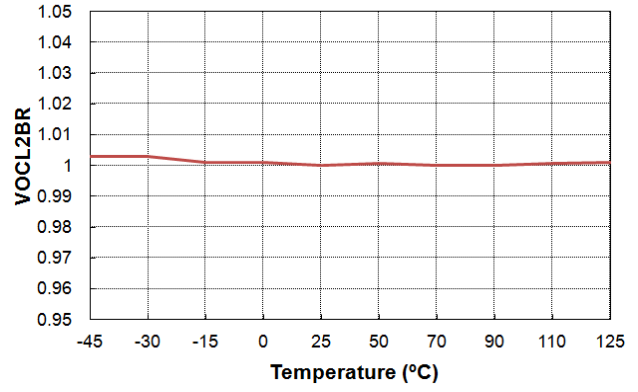

Figure 46. V_{OCL2BR} vs. Temperature

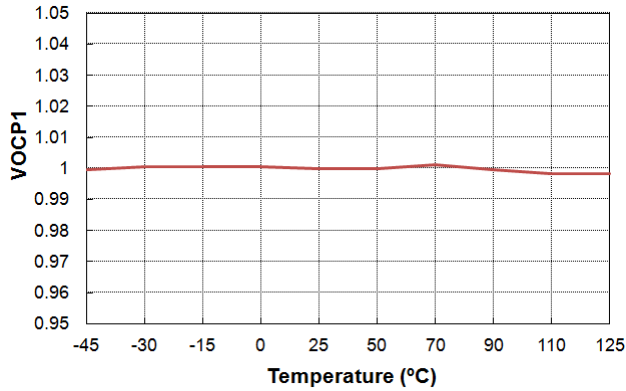

Figure 47. V_{OCP1} vs. Temperature

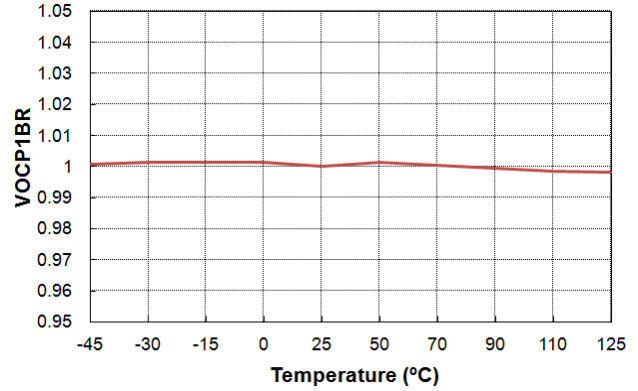

Figure 48. V_{OCP1BR} vs. Temperature

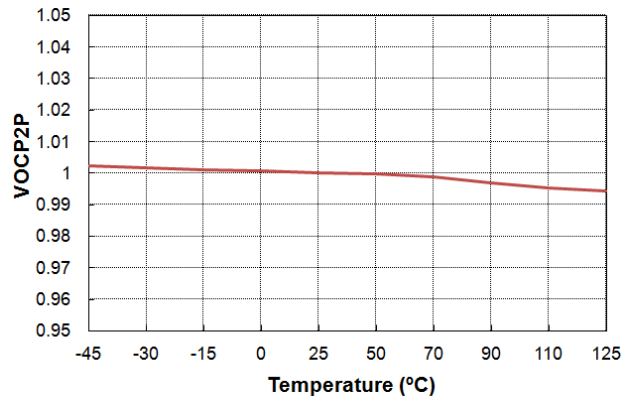

Figure 49. V_{OCP2P} vs. Temperature

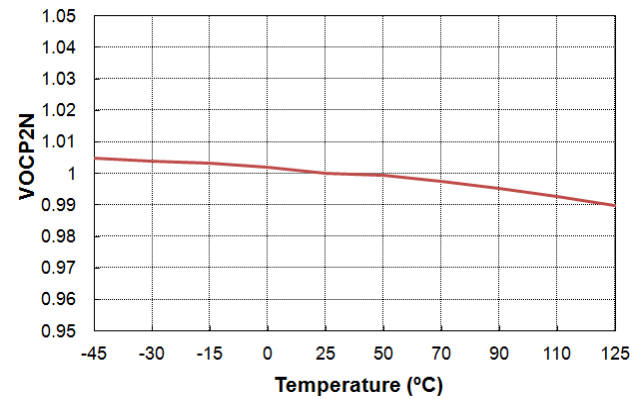

Figure 50. V_{OCP2N} vs. Temperature

NCP4390

TYPICAL PERFORMANCE CHARACTERISTICS

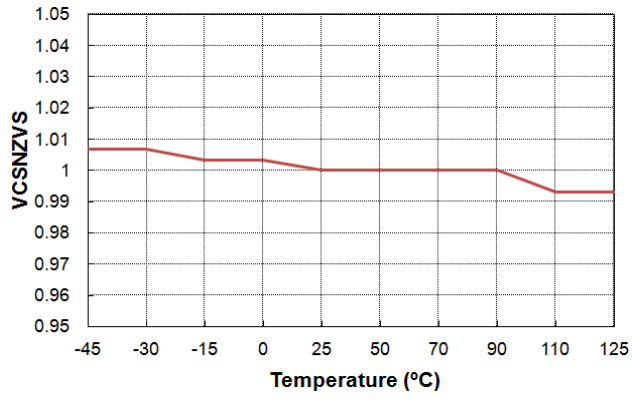

Figure 51. V_{CS.NZVS} vs. Temperature

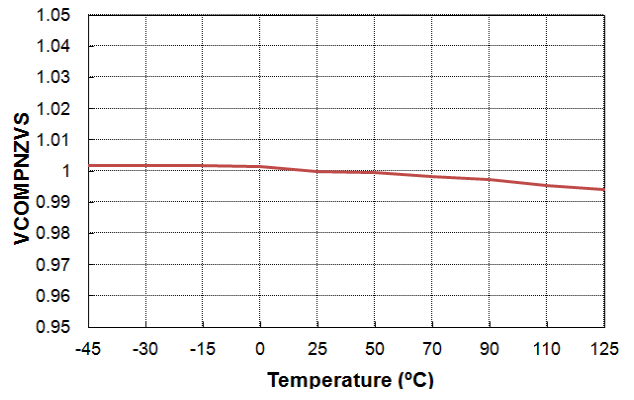

Figure 52. V_{COMP.NZVS} vs. Temperature

APPLICATION INFORMATION

Operation Principle of Charge Current Control

The LLC resonant converter has been widely used for many applications because it can regulate the output over entire load variations with a relatively small variation of switching frequency, and achieve Zero Voltage Switching (ZVS) for the primary side switches and Zero Current Switching (ZCS) for the secondary side rectifiers over the entire operating range. In addition, the resonant inductance can be integrated with the transformer into a single magnetic component. Figure 53 shows the simplified schematic of the LLC resonant converter where voltage mode control is employed. Voltage mode control is typically used for the LLC resonant converter where the error amplifier output voltage directly controls the switching frequency. However, the compensation network design of the LLC resonant converter is relatively challenging since the frequency response with voltage mode control includes four poles where the location of the poles changes with input voltage and load variations.

NCP4390 employs charge current mode control to improve the dynamic response of the LLC resonant converter. Figure 54 shows the simplified schematic of a half-bridge LLC resonant converter using NCP4390, where L_m is the magnetizing inductance, L_r is the resonant inductor and C_r is the resonant capacitor. Typical key waveforms of the LLC resonant converter for heavy load and light load conditions are illustrated in Figure 55 and Figure 56, respectively. It is assumed that the operation frequency is same as the resonance frequency, as determined by the resonance between L_r and C_r . Since the primary-side switch current does not increase monotonically, the switch current itself cannot be used for pulse-frequency-modulation (PFM) for the output voltage regulation. Also, the peak value of the primary-side current does not reflect the load condition properly because the large circulating current (magnetizing current) is included in the primary-side switch current. However, the integral of the switch current (V_{ICS}) does increase monotonically and has a peak value similar to that used for peak current mode control, as shown in Figure 55 and Figure 56.

Thus, NCP4390 employs charge current control, which compares the total charge of the switch current (integral of switch current) to the control voltage to modulate the switching frequency. Since the charge of the switch current is proportional to the average input current over one switching cycle, charge control provides a fast inner loop and offers excellent transient response including inherent line feed-forward. The PFM block has an internal timing capacitor (CT) whose charging current is determined by the

current flowing out of the FMIN pin. The FMIN pin voltage is regulated at 1.5 V.

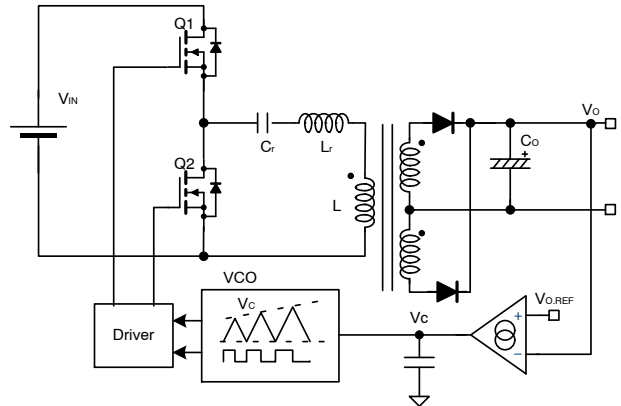

Figure 53. LLC Resonant Converter with Voltage Mode Control

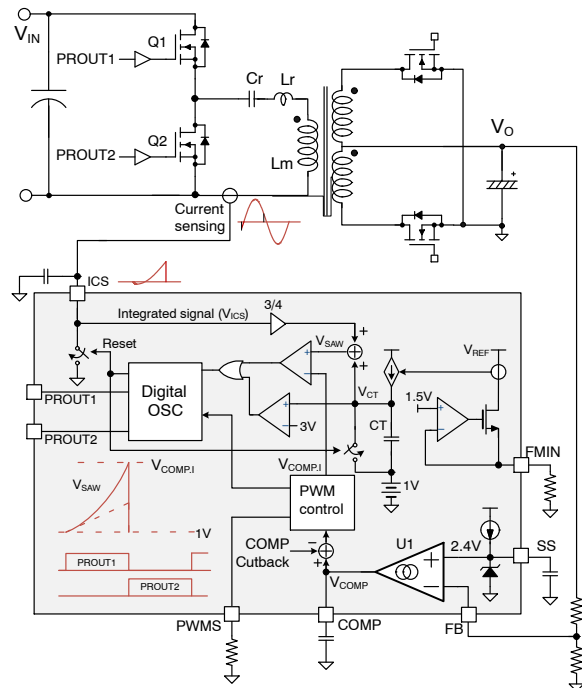

Figure 54. Schematic of LLC resonant Converter Power Stage Schematic

There is an upper limit (3 V) for the timing capacitor voltage, which determines the minimum switching frequency for a given resistor connected to the FMIN pin. The sawtooth waveform (V_{SAW}) is generated by adding the integral of the Q1 switch current (V_{ICS}) and the timing

capacitor voltage (V_{CT}) of the oscillator. The sawtooth waveform (V_{saw}) is then compared with the compensation voltage (V_{COMP}) to determine the switching frequency.

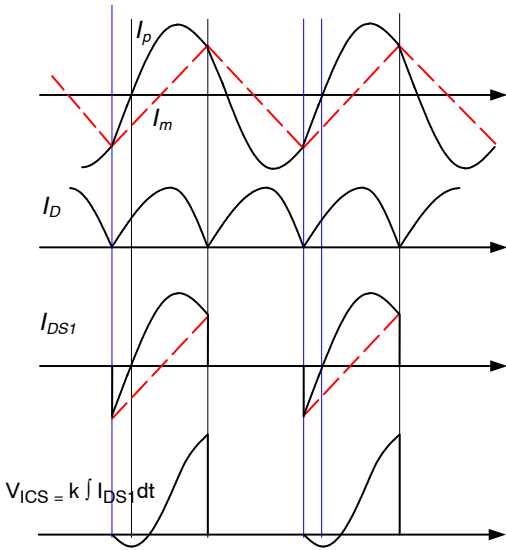

Figure 55. Typical Waveforms of the LLC Resonant Converter for Heavy Load Condition

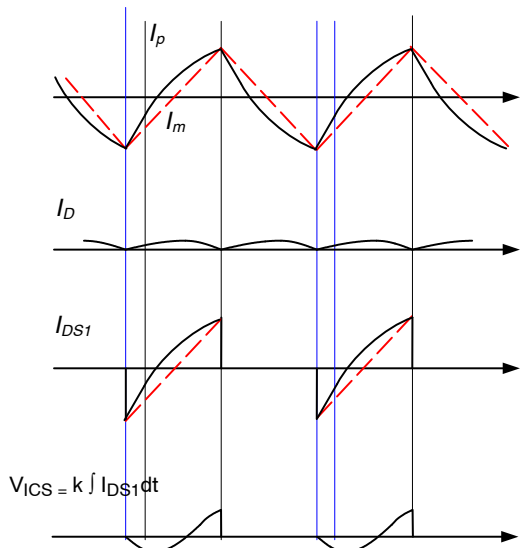

Figure 56. Typical Waveforms of LLC Resonant Converter for Light-Load Condition

Hybrid Control (PWM + PFM)

The conventional PFM control method modulates only the switching frequency with a fixed duty cycle of 50%, which typically results in relatively poor light load efficiency due to the large circulating primary side current.

To improve the light load efficiency, NCP4390 employs hybrid control where the PFM is switched to pulse width modulation (PWM) mode at light load as illustrated in Figure 57. If want to not uses PWM mode in light load condition, adjust PWM entry level using external PWM resistor for under skip threshold level. The figure 58 show that the switching frequency and duty ratio characteristics in disable PWM mode. The typical waveforms for PFM mode and PWM mode are shown in Figure 59 and Figure 60, respectively. When the error amplifier voltage (V_{COMP}) is below the PWM mode threshold, the internal COMP signal is clamped at the threshold level and the PFM operation switches to PWM mode.

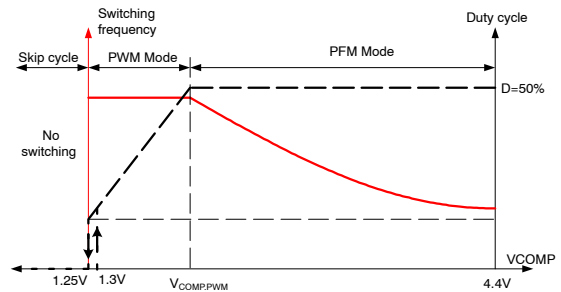

Figure 57. Mode Change with COMP Voltage

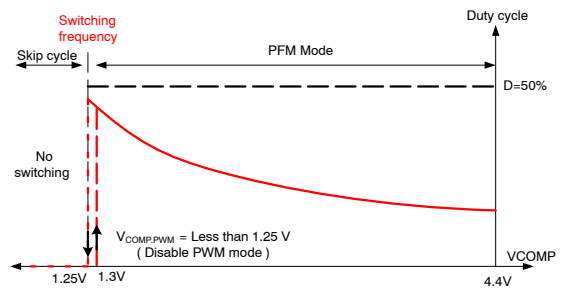

Figure 58. Disable PWM mode with COMP Voltage

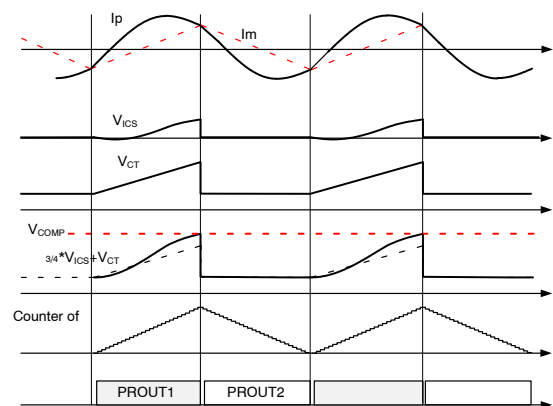

Figure 59. Key Waveforms of PFM Operation

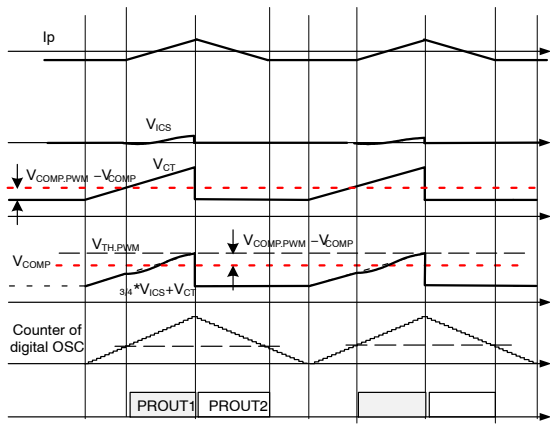

Figure 60. Key Waveforms of PWM Operation

In PWM mode, the switching frequency is fixed by the clamped internal COMP voltage (VCOMP1) and the duty cycle is determined by the difference between COMP voltage and the PWM mode threshold voltage. Thus, the duty cycle decreases as VCOMP drops below the PWM mode threshold, which limits the switching frequency at light load condition as illustrated in Figure 57. The PWM mode threshold can be programmed between 1.9 V and under skip threshold using a resistor on the PWMS pin. Disable PWM mode when the PWM mode threshold is set below 1.25 V.

Current Sensing

NCP4390 senses instantaneous switch current and the integral of the switch current as illustrated in Figure 61. Since NCP4390 is located in the secondary side, it is typical to use a current transformer for sensing the primary side current. While the PROUT1 is LOW, the ICS pin is clamped at 0 V with an internal reset MOSFET. Conversely, while PROUT1 is high, the ICS pin is not clamped and the integral capacitor (C_{ICS}) is charged and discharged by the voltage difference between the sensing resistor voltage (V_{SENSE}) and the ICS pin voltage. During normal operation, the voltage of the ICS pin is below 1.2 V since the power limit threshold is 1.2 V. The current sensing resistor and current transformer turns ratio should be designed such that the voltage across the current sensing resistor (V_{SENSE}) is greater than 4 V at the full load condition. Therefore the current charging and discharging C_{ICS} should be almost proportional to the voltage across the current sensing resistor (V_{SENSE}). Figure 62 compares the V_{ICS} signal and the ideal integral signal when the amplitude of V_{SENSE} is 4 V. As can be seen, there is about 10% error in the V_{ICS} signal compared to the ideal integral signal, which is acceptable for most designs. If more accuracy of the V_{ICS} is required, the amplitude of V_{SENSE} should be increased.

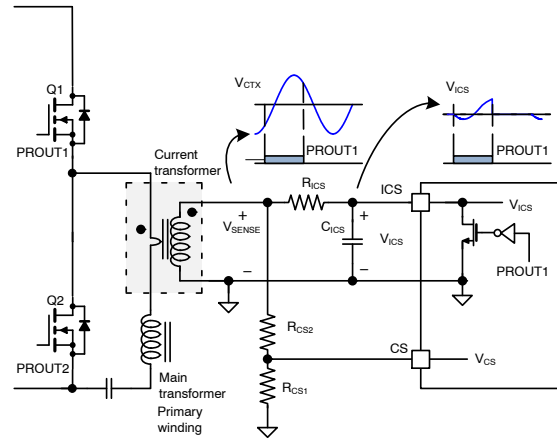

Figure 61. Current Sensing of NCP4390

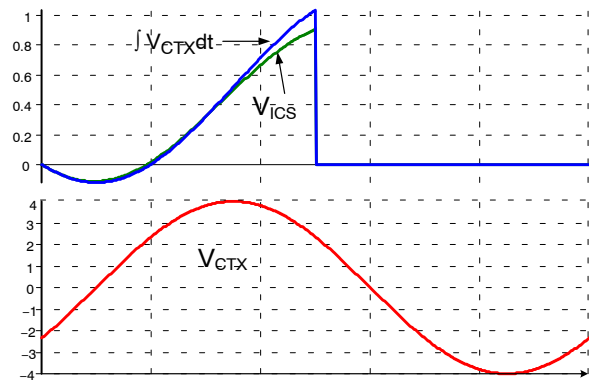

Figure 62. Disable PWM mode with COMP Voltage

Since the peak value of the integral of the current sensing voltage (V_{ICS}) is proportional to the average input current of the LLC resonant converter, it is used for four main functions, listed and shown in Figure 63.

1. SR Gate Shrink: To guarantee stable SR operation during light load operation, the SR dead time (both of turn-on and turn-off transitions) is increased resulting in SR gate shrink when V_{ICS} peak value drops below V_{TH1} (0.2 V). The SR dead time is reduced to the programmed value when V_{ICS} peak value rises above 0.25 V
2. SR Disable and Enable: During very light-load condition, the SR is disabled when the V_{ICS} peak value is smaller than V_{TH3} (0.075 V). When the V_{ICS} peak value increases above V_{TH2} (0.15 V), the SR is enabled

- Over-Current Limit: The V_{ICS} peak value is also used for input current limit. As can be seen in Figure 64, there exist two different current limits (fast and slow). When the V_{ICS} peak value increases above the slow current limit level (V_{OCL1}) due to a mild overload condition, the internal feedback compensation voltage is slowly reduced to limit the input power. This continues until the V_{ICS} peak value drops below V_{OCL1} . During a more severe over load condition, the V_{ICS} peak value crosses the fast current limit threshold (V_{OCL2}) and the internal feedback compensation voltage is quickly reduced to limit the input power as shown in Figure 64 (b). This continues until the V_{ICS} peak value drops below V_{OCL2} . The current limit threshold on the V_{ICS} peak value also changes as the output voltage sensing signal (V_{FB}) decreases such that output current is limited during overload condition as shown in Figure 65. In addition, these limit thresholds change to higher values ($V_{OCL1.BR}$ and $V_{OCL2.BR}$) when the converter operates in deep below resonance operation for a longer holdup time (refer to holdup time boost function)
- Over-Current Protection (OCP1): When the V_{ICS} peak value is larger than V_{OCP1} (1.9 V), the over current protection is triggered. 150 ns debounce time is added for over-current protection. These OCP threshold can be changed to a higher value ($V_{OCP1.BR}$) when the converter operates in deep below resonance operation for a longer holdup time (refer to holdup time boost function)

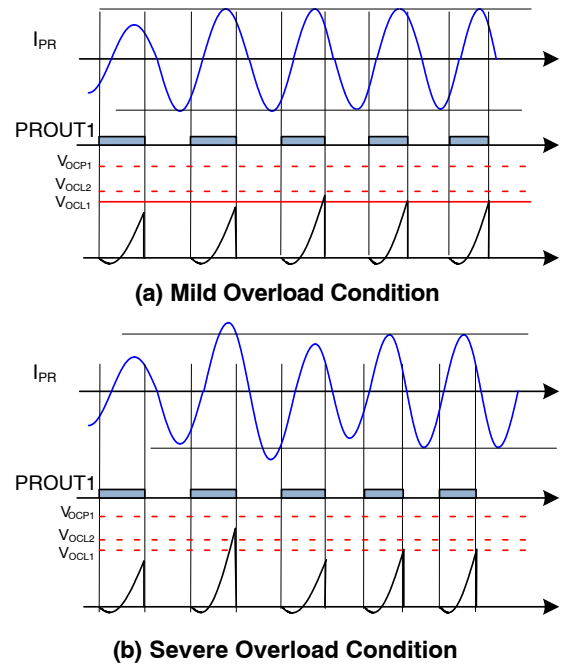

Figure 64. Current Limit of the ICS Pin by Frequency Shift (Compensation Cutback)

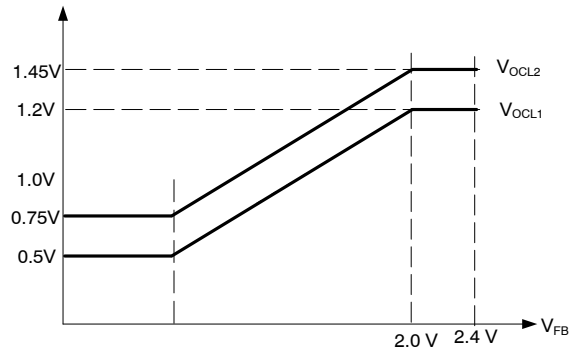

Figure 65. Current Limit Threshold Modulation as a Function of Feedback Voltage

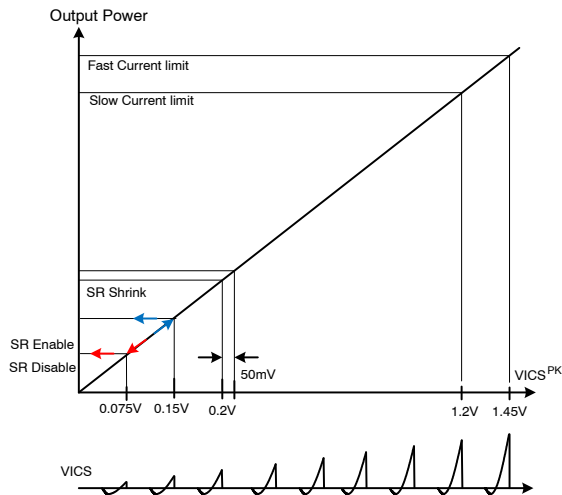

Figure 63. Functions Related to VICS Peak Voltage

The instantaneous switch current sensing on the CS pin is also used for the following functions.

1. Non-ZVS Prevention: When the compensation voltage (V_{COMP}) is higher than 3 V and V_{CS} peak value is smaller than 0.3 V at PROUT1 falling edge, non-ZVS condition is detected, which decreases the internal compensation signal to increase the switching frequency
2. Over-Current Protection (OCP2): When V_{CS} is higher than 3.5 V or lower than -3.5 V, over-current protection (OCP2) is triggered. The instantaneous primary side current is also sensed on CS pin. Since the OCP2 thresholds on the CS pin are 3.5 V and -3.5 V as shown in Figure 66, the CS signal is typically obtained from V_{SENSE} by using a voltage divider as illustrated in Figure 61. 150 ns debounce time is also added for OCP2

Figure 67 shows utilization of current sensing by using ICS and CS signals.

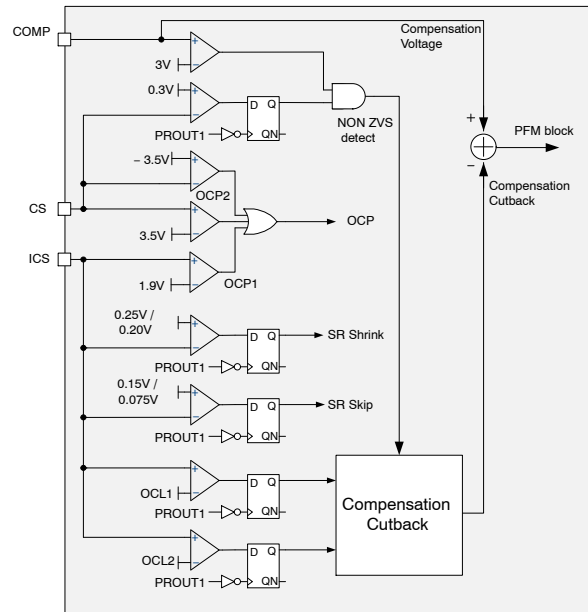

Figure 67. Utilization of Current Sensing Signal

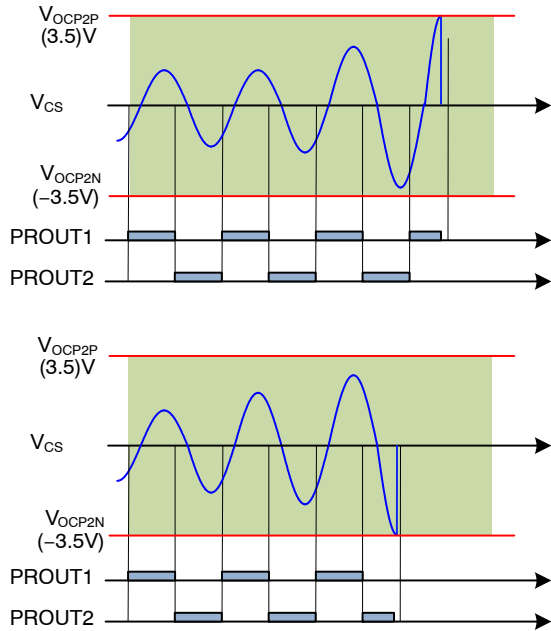

Figure 66. Over-Current Protection of the CS Pin

Soft-Start and Output Voltage Regulation

Figure 68 shows the simplified circuit block for feedback control and closed loop soft-start. During normal, steady state operation, the Soft-Start (SS) pin is connected to the non-inverting input of the error amplifier which is clamped at 2.4 V. The feedback loop operates such that the sensed output voltage is same as the SS pin voltage. During startup, an internal current source ($I_{SS,T}$) charges the SS capacitor and SS pin voltage progressively increases. Therefore, the output voltage also rises monotonically as a result of closed loop SS control.

The SS capacitor is also used for the shutdown delay time during overload protection (OLP). Figure 69 shows the OLP waveform. During normal operation, the SS capacitor voltage is clamped at 2.4 V. When the output is over-loaded, V_{COMP} is saturated to HIGH and the SS capacitor is decoupled from the clamping circuit through the SS control block. I_{SS} is blocked by D_{BLCK} and the SS capacitor is slowly charged up by the current source $I_{SS,UP}$. When the SS capacitor voltage reaches 3.6 V, OLP is triggered. The time required for the soft-start capacitor to be charged from 2.4 V to 3.6 V determines the shutdown delay time for overload protection.

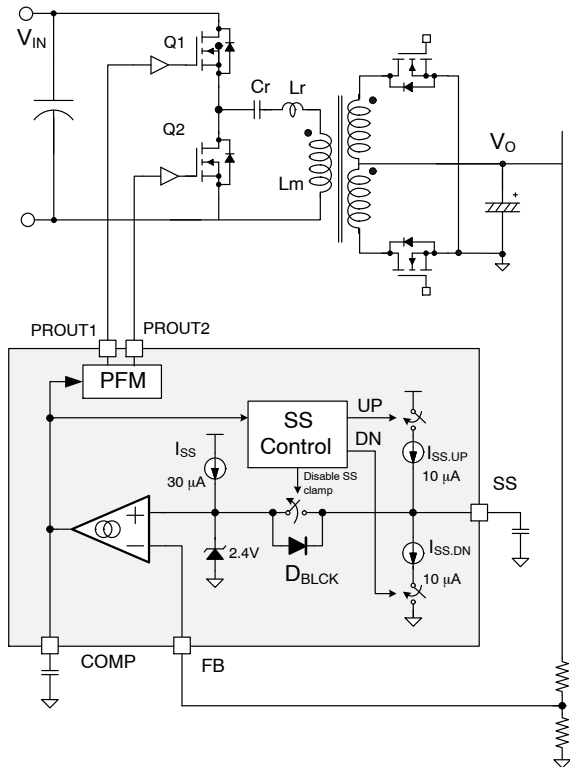

Figure 68. Schematic of Closed Loop Soft-Start

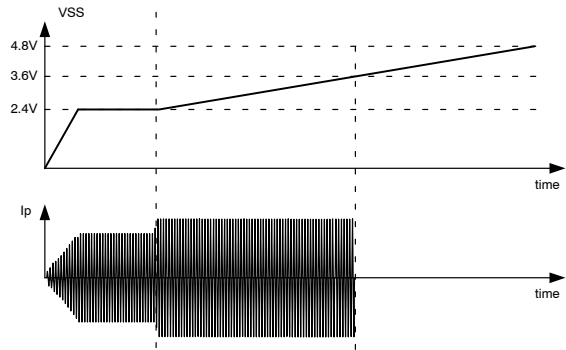

Figure 69. Delayed Shutdown with Soft-Start

Auto-Restart after Protection

All protections of NCP4390 are non-latching, auto-restart, where the delayed restart is implemented by charging and discharging the SS capacitor as illustrated in Figure 70. During normal operation, the SS capacitor voltage is clamped at 2.4 V. Once any protection is triggered, the SS clamping circuit is disabled. The SS capacitor is then charged up to 4.7 V by an internal current source ($I_{SS,UP}$). The SS capacitor is then discharged down to 0.1 V by another internal current ($I_{SS,DN}$). After charging and discharging the SS capacitor three more times, auto recovery is enabled.

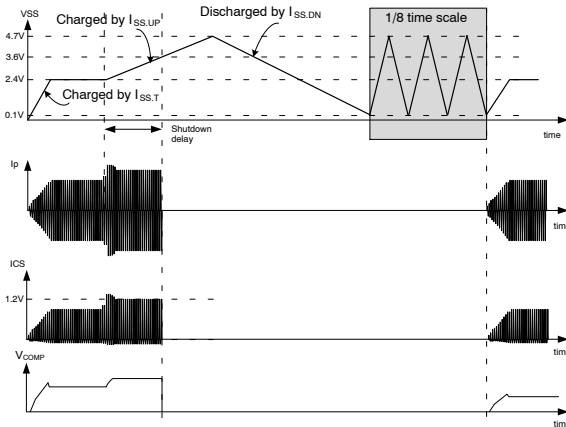

Figure 70. Auto Re-Start after Protection is Triggered

Output Short Protection

To minimize the power dissipation through the power stage during a severe fault condition, NCP4390 offers Output Short Protection (OSP). When the output is heavily over-loaded or short circuited, the feedback voltage (output voltage sensing) does not follow the reference voltage of the error amplifier (2.4 V). When the difference between the reference voltage of the error amplifier and the FB voltage is larger than 1.2 V, the OSP is triggered without waiting until the OLP is triggered as shown in Figure 71.

Dead-Time Setting

With a single pin (RDT pin), the dead times between the primary side gate drive signals (PROUT1 and PROUT2) and secondary side SR gate drive signal (SROUT1 and SROUT2) are programmed using a switched current source as shown in Figure 72 and Figure 73. Once the 5 V bias is enabled, the RDT pin voltage is pulled up. When the RDT pin voltage reaches 1.4 V, the voltage across C_{DT} is then discharged down to 1 V by an internal current source I_{DT} . I_{DT} is then disabled and the RDT pin voltage is charged up by the RDT resistor. As shown in Figure 73, 1/64 of the time required (T_{SET1}) for RDT pin voltage to rise from 1 V to 3 V determines the dead time between the secondary side SR gate drive signals.

The switched current source I_{DT} is then enabled and the RDT pin voltage is discharged. 1/32 of the time required (T_{SET2}) for the RDT pin voltage to drop from 3 V to 1 V determines the dead time between the primary side gate drive signals. After the RDT voltage drops to 1 V, the current source I_{DT} is disabled a second time, allowing the RDT voltage to be charged up to 5 V.

Table 1 shows the dead times for SROUT and PROUT programmed with recommended RDT and CDT component values. Since the time is measured by an internal 40 MHz clock signal, the resolution of the dead time setting is 25 ns.

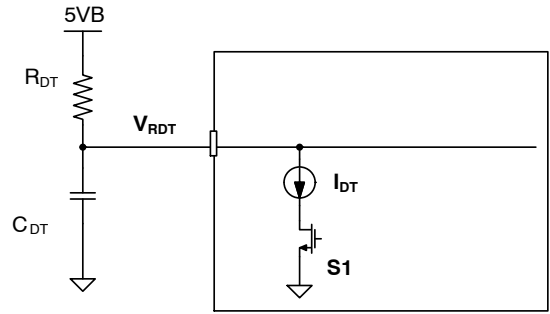

Figure 72. Internal Current Source for of RDT Pin

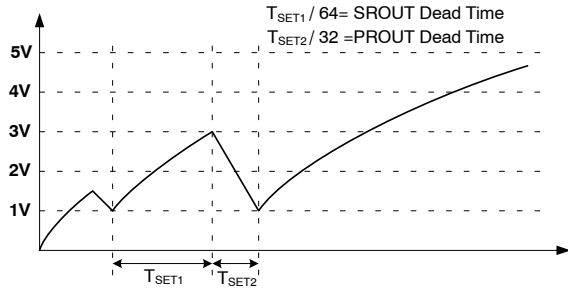

Figure 73. Multi-function Operation of RDT Pin

The minimum and maximum dead times are therefore limited at 75 ns and 375 ns respectively. To assure stable SR operation while taking circuit parameter tolerance into account, 75 ns dead time is not recommended especially for the SR dead time.

When NCP4390 operates in PWM mode at light-load condition, the dead time is doubled to reduce the switching loss.

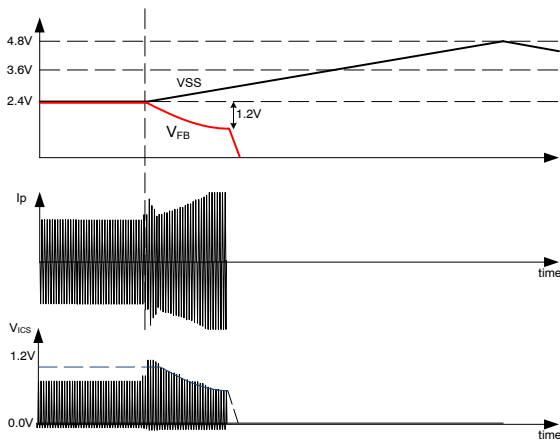

Figure 71. Output Short Protection

Table 1. DEAD TIME SETTING FOR PROUT AND SROUT

R _{DT}	C _{DT} = 180 pF		C _{DT} = 220 pF		C _{DT} = 270pF		C _{DT} = 330 pF		C _{DT} = 390 pF		C _{DT} = 470 pF		C _{DT} = 560 pF	
	SROUT DT (ns)	PROUT DT (ns)	SROUT DT (ns)	PROUT DT (ns)	SROUT DT (ns)	PROUT DT (ns)	SROUT DT (ns)	PROUT DT (ns)	SROUT DT (ns)	PROUT DT (ns)	SROUT DT (ns)	PROUT DT (ns)	SROUT DT (ns)	PROUT DT (ns)
28 k	75	375	75	375	75	375	100	375	125	375	150	375	175	375
30 k	75	250	75	325	100	375	100	375	125	375	150	375	175	375
33 k	75	200	75	250	100	300	125	375	150	375	175	375	200	375
36 k	75	175	75	200	100	250	125	325	150	375	175	375	225	375
40 k	75	150	100	175	125	225	150	275	175	325	200	375	250	375
44 k	75	125	100	150	125	200	150	250	175	300	225	350	275	375
48 k	100	125	125	150	150	175	175	225	200	275	250	325	300	375
53 k	100	100	125	125	150	175	200	200	225	250	275	300	325	375
58 k	125	100	150	125	175	150	200	200	250	250	300	300	350	350
64 k	125	100	150	125	175	150	225	200	275	225	325	275	375	325
71 k	150	100	175	125	200	150	250	175	300	225	350	250	375	325
78 k	150	100	175	100	225	150	275	175	325	200	375	250	375	300
86 k	175	75	200	100	250	125	300	175	375	200	375	250	375	300
94 k	175	75	225	100	275	125	325	175	375	200	375	225	375	275
104 k	200	75	250	100	300	125	375	150	375	200	375	225	375	275
114 k	225	75	275	100	325	125	375	150	375	175	375	225	375	275
126 k	250	75	300	100	375	125	375	150	375	175	375	225	375	275
138 k	275	75	325	100	375	125	375	150	375	175	375	225	375	250
152 k	300	75	350	100	375	125	375	150	375	175	375	225	375	250

Minimum Frequency Setting

The minimum switching frequency is limited by comparing the timing capacitor voltage (V_{CT}) with an internal 3 V reference as shown in Figure 74. Since the rising slope of the timing capacitor voltage is determined by the resistor (R_{FMIN}) connected to FMIN pin, the minimum switching frequency is given as:

$$f_{SW,MIN} = 100 \text{ kHz} \times \frac{10 \text{ k}\Omega}{R_{FMIN}} \quad (\text{eq. 1})$$

The minimum programmable switching frequency is limited by the digital counter running on an internal 40 MHz clock. Since a 10 bit counter is used, the minimum switching

frequency given by the digital oscillator is 39 kHz (40 MHz/1024 = 39 kHz). Therefore, the maximum allowable value for R_{FMIN} is 25.5 KΩ.

PWM Mode Entry Level Setting

When the COMP voltage drops below V_{COMP,PWM} as a result of decreasing load, the internal COMP signal is clamped at the threshold level and PFM operation switches to PWM Mode. The PWM entry level threshold is programmed using a external resistor on the PWMS pin as shown in Figure 75. Once NCP4390 enters into PWM mode, the SR gate drives are disabled. If want to uses specially disable PWM mode, open PWMS pin or connect to 1 MΩ.

Skip Cycle Operation

As illustrated in Figure 76, when the COMP voltage drops below $V_{COMP.SKIP}$ (1.25 V) as a result of decreasing load, skip cycle operation is employed to reduce switching losses. As the COMP voltage rises above 1.3 V, the switching operation is resumed. When the FB voltage rises above $V_{FB.OVP1}$ (2.65 V), the skip cycle operation is also enabled to limit the output voltage rising quickly. As the FB voltage drops below $V_{FB.OVP2}$ (2.3 V), the switching operation is resumed.

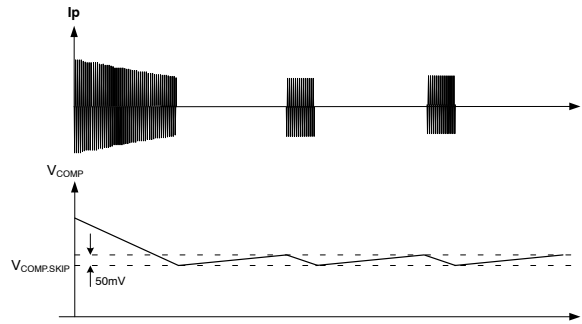

Figure 76. Skip Cycle Operation

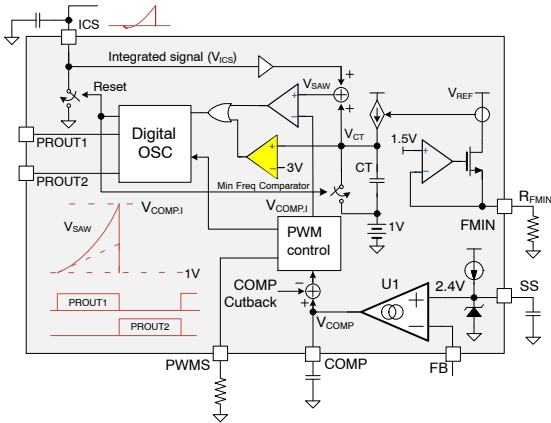
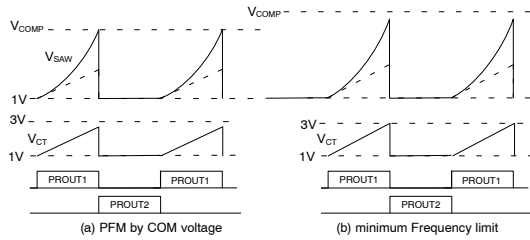

Figure 74. Minimum Switching Frequency Setting



Figure 75. PWM Mode Entry Level Setting

NCP4390 uses a dual edge tracking adaptive gate drive method that anticipates the SR current zero crossing instant with respect to two different time references. Figure 77 and Figure 78 show the operational waveforms of the dual edge tracking adaptive SR drive method operating below and above resonance. To simplify the explanation, the SR dead time is assumed to be zero. The first tracking circuit measures SR conduction time ($T_{SR_CONDCTN}$) and uses this information to generate the first adaptive drive signal (V_{PRD_DRV1}) for the next switching cycle whose duration is the same as the SR conduction time of previous switching cycle. The second tracking circuit measures the turn-off extension time which is defined as time duration from the falling edge of the primary side drive to the corresponding SR turn-off instant (T_{EXT}). This information is then used to generate the second adaptive drive signal (V_{PRD_DRV2}) for the next switching cycle. When the turn-off of the primary side drive signal is after the turn-off of the corresponding SR for below resonance operation, the second adaptive SR drive signal is the same as the corresponding primary side gate drive signal. However, when the turn-off of the primary side drive signal is before the turn-off instant of the corresponding SR for above resonance operation, the second adaptive SR drive signal is generated by extending the corresponding primary side gate drive signal by T_{EXT} of the previous switching cycle.

Since the turn off instant of the second adaptive gate drive signal is extended by T_{EXT} with respect to the falling edge of the primary side gate drive signal, the duration of this signal consequentially changes with switching frequency. By combining these two signals V_{PRD_DRV1} and V_{PRD_DRV2} with an AND gate, the optimal adaptive gate drive signal is obtained.

The SR conduction times for SR1 and SR2 for each switching cycle are measured using a single pin (SR1DS pin). The SR1DS voltage and its delayed signal, resulting

from a 100 ns RC time constant, are compared as shown in Figure 79. When the SR is conducting, the SR1DS voltage is clamped to either ground or the high voltage rail (2 times the output voltage) as illustrated in Figure 80. Whereas, SR1DS voltage changes fast when there is a switching transition. When both of the SR MOSFETs are turned off, the SR1DS voltage oscillates. When the SR1DS voltage changes faster than 0.25 V/100 ns on the rising edge and 0.2 V/100 ns on the falling edge the switching transition of the SR conduction state is detected. Based on the detected switching transition, NCP4390 predicts the SR current zero-crossing instant for the next switching cycle. The 100 ns detection delay caused by the RC time constant is compensated in the internal timing detection circuit for a correct gate drive for SR.

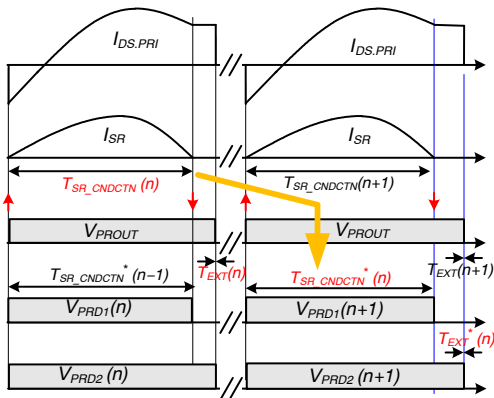

Figure 77. Operation of Dual Edge Tracking Adaptive SR Control (below Resonance)

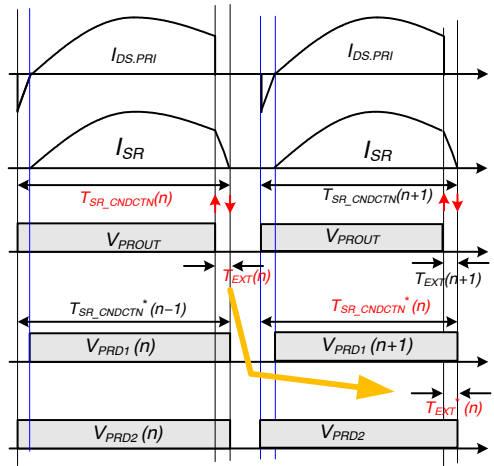

Figure 78. Operation of Dual Edge Tracking Adaptive SR Control (above Resonance)

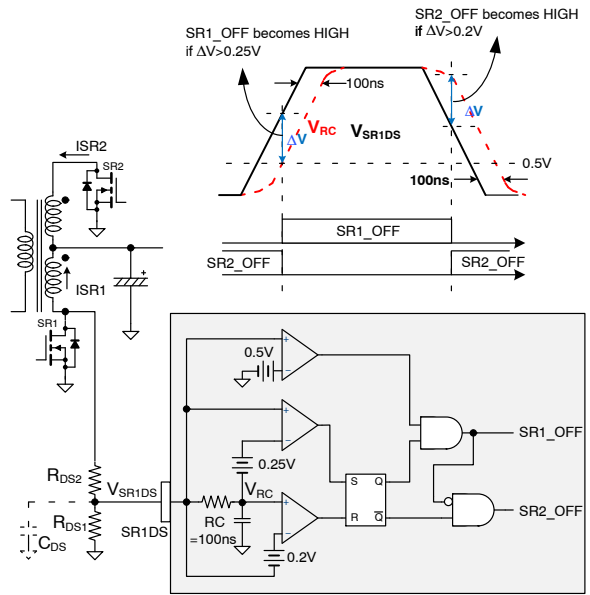

Figure 79. SR Conduction Detection with Single Pin (SR1DS Pin)

Figure 80 and Figure 81 show the typical waveforms of SR1DS pin voltage together with other key waveforms. Since the voltage rating of SR1DS pin is 5 V, the voltage divider should be properly designed such that no over-voltage is applied to this pin. Additional bypass capacitor (CDS) can be connected to SR1DS pin to improve noise immunity. However, the equivalent time constant generated from the bypass capacitor and voltage divider resistors should be smaller than the internal RC time constant (100 ns) of the detection circuit for proper SR current zero crossing detection.

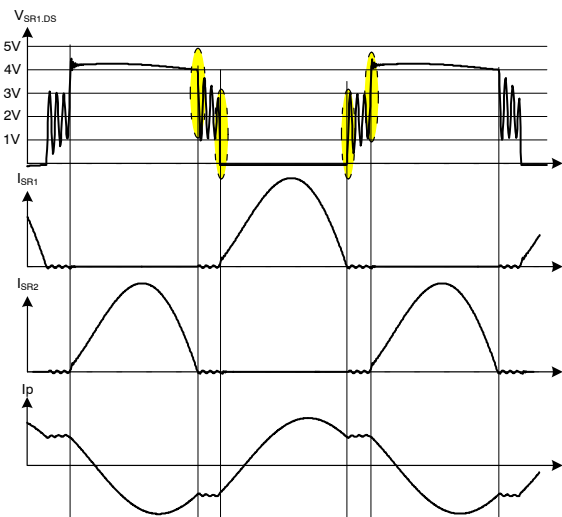

Figure 80. SR Conduction Detection Waveform at below Resonance Operation

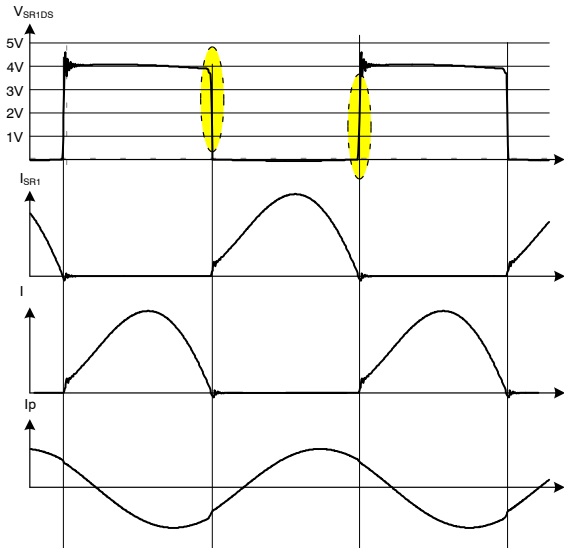

Figure 81. SR Conduction Detection Waveform at above Resonance Operation

Holdup Time Boost Function

The holdup time of an off-line supply is defined as the time required for the output voltage to remain within regulation after the AC input voltage is removed. Since the input bulk capacitor voltage drops during the holdup time, more current is taken from the bulk capacitor to deliver the same power to the load. With a fixed power limit level of power supply designed for nominal input voltage, the holdup time tends to be limited due to the increased input current of the power supply.

NCP4390 has a holdup time boost function which increases the current limit threshold on the ICS pin voltage when the LLC resonant converter operates in deep below

resonance operation during the holdup time as shown in Figure 82. This holdup time boost operation is enabled when the SR conduction time is smaller than 94% of the half switching cycle for longer than 1.6 ms. The current limit level on ICS pin is recovered to normal value when the SR conduction time is larger than 98% of the half switching cycle for longer than 3.2 ms.

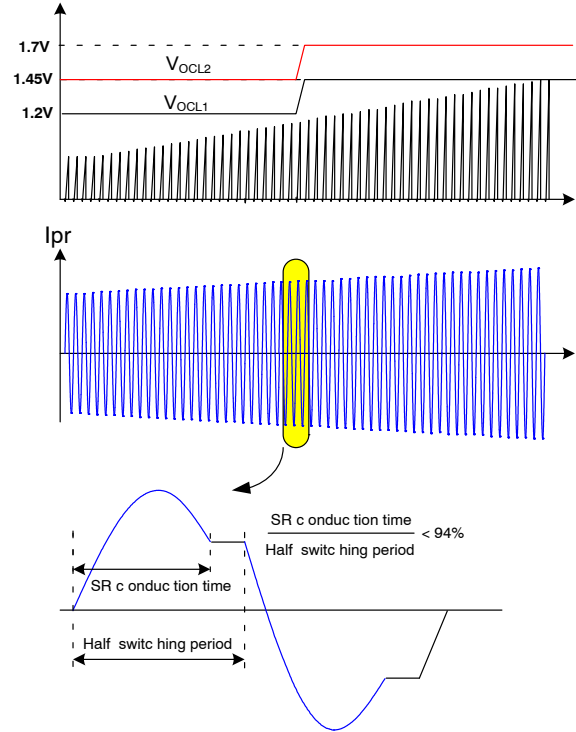

Figure 82. Holdup Time Boost Function Operation

QUICK SETUP GUIDELINE for CURRENT SENSING and SOFT-START

Assuming the switching frequency is the same as the resonance frequency, the peak v of the secondary side voltage of current transformer (V_{SENSE}) is given as:

$$V_{SENSE}^{PK} = I_O \times \frac{\pi}{2} \times \frac{N_S}{N_P} \times \frac{1}{n_{CT}} \times (R_{CS1} + R_{CS2})$$

[example] $I_O = 20\text{ A}$, $N_P = 35$, $N_S = 2$, $n_{CT} = 50$, $R_{CS1} + R_{CS2} = 100\ \Omega \rightarrow V_{SENSE}^{PK} = 3.59\text{ V}$ in nominal load condition.

The voltage divider on the CS pin should be selected such that OCP is not triggered during normal operation.

$$V_{CS}^{PK} = I_O \times \frac{\pi}{2} \times \frac{N_S}{N_P} \times \frac{1}{n_{CT}} \times R_{CS1} < 3.5\text{ V}$$

[example] $I_O = 21\text{ A}$, $N_P = 35$, $N_S = 2$, $n_{CT} = 50$, $R_{CS1} = 30\ \Omega$, $R_{CS2} = 70\ \Omega \rightarrow V_{CS}^{PK} = 1.131\text{ V}$ in nominal load condition.

The resistor and capacitor on the ICS pin should be selected such that the current limit is not triggered during normal operation.

$$V_{ICS}^{PK} = I_O \times \frac{N_S}{N_P} \times \frac{1}{n_{CT}} \times \frac{R_{CS1} + R_{CS2}}{R_{ICS}} \times \frac{1}{C_{ICS}} \times \frac{1}{2} f_{SW} < 1.2\text{ V}$$

[example] $I_O = 20\text{ A}$, $N_P = 35$, $N_S = 2$, $n_{CT} = 50$, $R_{CS1} = 30\ \Omega$, $R_{CS2} = 70\ \Omega$, $R_{ICS} = 10\text{ k}\Omega$, $C_{ICS} = 1\text{ nF}$, $f_S = 100\text{ kHz}$.

$\rightarrow V_{ICS}^{PK} = 1.14\text{ V}$ in nominal load condition (actual V_{ICS}^{PK} is lower by about 10% as shown in Figure 62 due to a quasi integral effect).

Assuming the actual V_{ICS}^{PK} (V_{ICS}^{PKA}) is 1 V, the soft-start capacitor should be selected such that the overload protection is not triggered during startup with full load condition.

$$T_{SS} = \frac{C_{SS} \times 2.4\text{ V}}{I_{SS}} = 40.8\text{ ms} > \frac{C_{OUT} \times V_O}{\frac{1.2 - V_{ICS}^{PK}}{V_{ICS}^{PK}} \times I_O} = 22.5\text{ ms}$$

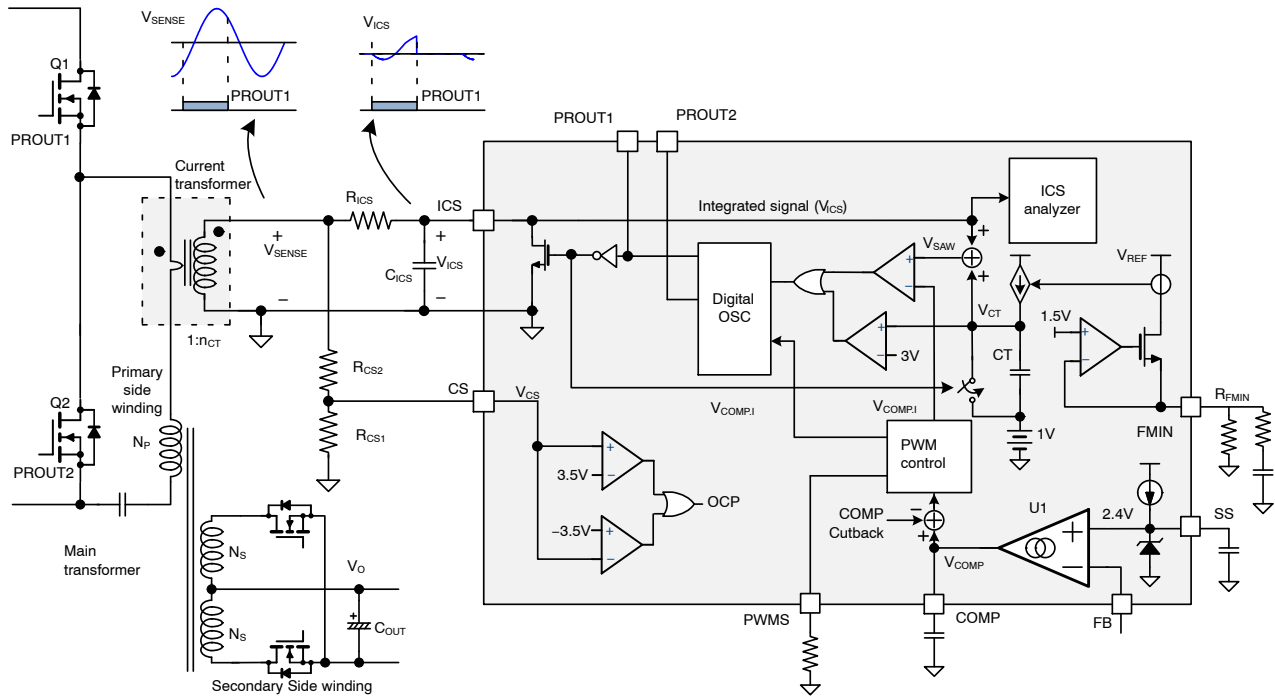

Figure 83. Basic Application Circuit for Current Sensing and Soft-Start

MECHANICAL CASE OUTLINE PACKAGE DIMENSIONS

ON Semiconductor®



SCALE 1:1

SOIC-16 CASE 751B-05 ISSUE K

DATE 29 DEC 2006



NOTES:

1. DIMENSIONING AND TOLERANCING PER ANSI Y14.5M, 1982.
2. CONTROLLING DIMENSION: MILLIMETER.
3. DIMENSIONS A AND B DO NOT INCLUDE MOLD PROTRUSION.
4. MAXIMUM MOLD PROTRUSION 0.15 (0.006) PER SIDE.
5. DIMENSION D DOES NOT INCLUDE DAMBAR PROTRUSION. ALLOWABLE DAMBAR PROTRUSION SHALL BE 0.127 (0.005) TOTAL IN EXCESS OF THE D DIMENSION AT MAXIMUM MATERIAL CONDITION.

DIM	MILLIMETERS		INCHES	
	MIN	MAX	MIN	MAX
A	9.80	10.00	0.386	0.393
B	3.80	4.00	0.150	0.157
C	1.35	1.75	0.054	0.068
D	0.35	0.49	0.014	0.019
F	0.40	1.25	0.016	0.049
G	1.27 BSC		0.050 BSC	
J	0.19	0.25	0.008	0.009
K	0.10	0.25	0.004	0.009
M	0°	7°	0°	7°
P	5.80	6.20	0.229	0.244
R	0.25	0.50	0.010	0.019

- | | | | |
|---|---|---|---|
| <p>STYLE 1:</p> <p>PIN 1. COLLECTOR
2. BASE
3. EMITTER
4. NO CONNECTION
5. EMITTER
6. BASE
7. COLLECTOR
8. COLLECTOR
9. BASE
10. EMITTER
11. NO CONNECTION
12. EMITTER
13. BASE
14. COLLECTOR
15. EMITTER
16. COLLECTOR</p> | <p>STYLE 2:</p> <p>PIN 1. CATHODE
2. ANODE
3. NO CONNECTION
4. CATHODE
5. CATHODE
6. NO CONNECTION
7. ANODE
8. CATHODE
9. CATHODE
10. ANODE
11. NO CONNECTION
12. CATHODE
13. CATHODE
14. NO CONNECTION
15. ANODE
16. CATHODE</p> | <p>STYLE 3:</p> <p>PIN 1. COLLECTOR, DYE #1
2. BASE, #1
3. EMITTER, #1
4. COLLECTOR, #1
5. COLLECTOR, #2
6. BASE, #2
7. EMITTER, #2
8. COLLECTOR, #2
9. COLLECTOR, #3
10. BASE, #3
11. EMITTER, #3
12. COLLECTOR, #3
13. COLLECTOR, #4
14. BASE, #4
15. EMITTER, #4
16. COLLECTOR, #4</p> | <p>STYLE 4:</p> <p>PIN 1. COLLECTOR, DYE #1
2. COLLECTOR, #1
3. COLLECTOR, #2
4. COLLECTOR, #2
5. COLLECTOR, #3
6. COLLECTOR, #3
7. COLLECTOR, #4
8. COLLECTOR, #4
9. BASE, #4
10. EMITTER, #4
11. BASE, #3
12. EMITTER, #3
13. BASE, #2
14. EMITTER, #2
15. BASE, #1
16. EMITTER, #1</p> |
| <p>STYLE 5:</p> <p>PIN 1. DRAIN, DYE #1
2. DRAIN, #1
3. DRAIN, #2
4. DRAIN, #2
5. DRAIN, #3
6. DRAIN, #3
7. DRAIN, #4
8. DRAIN, #4
9. GATE, #4
10. SOURCE, #4
11. GATE, #3
12. SOURCE, #3
13. GATE, #2
14. SOURCE, #2
15. GATE, #1
16. SOURCE, #1</p> | <p>STYLE 6:</p> <p>PIN 1. CATHODE
2. CATHODE
3. CATHODE
4. CATHODE
5. CATHODE
6. CATHODE
7. CATHODE
8. CATHODE
9. ANODE
10. ANODE
11. ANODE
12. ANODE
13. ANODE
14. ANODE
15. ANODE
16. ANODE</p> | <p>STYLE 7:</p> <p>PIN 1. SOURCE N-CH
2. COMMON DRAIN (OUTPUT)
3. COMMON DRAIN (OUTPUT)
4. GATE P-CH
5. COMMON DRAIN (OUTPUT)
6. COMMON DRAIN (OUTPUT)
7. COMMON DRAIN (OUTPUT)
8. SOURCE P-CH
9. SOURCE P-CH
10. COMMON DRAIN (OUTPUT)
11. COMMON DRAIN (OUTPUT)
12. COMMON DRAIN (OUTPUT)
13. GATE N-CH
14. COMMON DRAIN (OUTPUT)
15. COMMON DRAIN (OUTPUT)
16. SOURCE N-CH</p> | |

SOLDERING FOOTPRINT



DIMENSIONS: MILLIMETERS

DOCUMENT NUMBER:	98ASB42566B	Electronic versions are uncontrolled except when accessed directly from the Document Repository. Printed versions are uncontrolled except when stamped "CONTROLLED COPY" in red.
DESCRIPTION:	SOIC-16	PAGE 1 OF 1

ON Semiconductor and ON are trademarks of Semiconductor Components Industries, LLC dba ON Semiconductor or its subsidiaries in the United States and/or other countries. ON Semiconductor reserves the right to make changes without further notice to any products herein. ON Semiconductor makes no warranty, representation or guarantee regarding the suitability of its products for any particular purpose, nor does ON Semiconductor assume any liability arising out of the application or use of any product or circuit, and specifically disclaims any and all liability, including without limitation special, consequential or incidental damages. ON Semiconductor does not convey any license under its patent rights nor the rights of others.

onsemi, **Onsemi**, and other names, marks, and brands are registered and/or common law trademarks of Semiconductor Components Industries, LLC dba "**onsemi**" or its affiliates and/or subsidiaries in the United States and/or other countries. **onsemi** owns the rights to a number of patents, trademarks, copyrights, trade secrets, and other intellectual property. A listing of **onsemi**'s product/patent coverage may be accessed at www.onsemi.com/site/pdf/Patent-Marking.pdf. **onsemi** reserves the right to make changes at any time to any products or information herein, without notice. The information herein is provided "as-is" and **onsemi** makes no warranty, representation or guarantee regarding the accuracy of the information, product features, availability, functionality, or suitability of its products for any particular purpose, nor does **onsemi** assume any liability arising out of the application or use of any product or circuit, and specifically disclaims any and all liability, including without limitation special, consequential or incidental damages. Buyer is responsible for its products and applications using **onsemi** products, including compliance with all laws, regulations and safety requirements or standards, regardless of any support or applications information provided by **onsemi**. "Typical" parameters which may be provided in **onsemi** data sheets and/or specifications can and do vary in different applications and actual performance may vary over time. All operating parameters, including "Typicals" must be validated for each customer application by customer's technical experts. **onsemi** does not convey any license under any of its intellectual property rights nor the rights of others. **onsemi** products are not designed, intended, or authorized for use as a critical component in life support systems or any FDA Class 3 medical devices or medical devices with a same or similar classification in a foreign jurisdiction or any devices intended for implantation in the human body. Should Buyer purchase or use **onsemi** products for any such unintended or unauthorized application, Buyer shall indemnify and hold **onsemi** and its officers, employees, subsidiaries, affiliates, and distributors harmless against all claims, costs, damages, and expenses, and reasonable attorney fees arising out of, directly or indirectly, any claim of personal injury or death associated with such unintended or unauthorized use, even if such claim alleges that **onsemi** was negligent regarding the design or manufacture of the part. **onsemi** is an Equal Opportunity/Affirmative Action Employer. This literature is subject to all applicable copyright laws and is not for resale in any manner.

ADDITIONAL INFORMATION

TECHNICAL PUBLICATIONS:

Technical Library: www.onsemi.com/design/resources/technical-documentation
onsemi Website: www.onsemi.com

ONLINE SUPPORT: www.onsemi.com/support

For additional information, please contact your local Sales Representative at www.onsemi.com/support/sales