

Linear Regulator - Dual-Rail, Very Low-Dropout, Programmable Soft-Start

3.0 A

NCP59744

The NCP59744 is dual-rail very low dropout voltage regulator that is capable of providing an output current in excess of 3.0 A with a dropout voltage of 75 mV typ. at full load current. The devices are stable with ceramic and other low ESR output capacitors. This series contains adjustable output voltage version with output voltage down to 0.8 V. Internal protection features consist of built-in thermal shutdown and output current limiting protection. User-programmable Soft-Start and Power Good pins are available. The NCP59744 is offered in DFN10 3x3, QFN20 5x5 and WLCSP10 packages.

Features

- Output Current in Excess of 3.0 A
- 0.25% Typical Accuracy Over Line and Load
- V_{IN} Range: 0.8 V to 5.5 V
- V_{BIAS} Range: 2.2 V to 5.5 V
- Output Voltage Range: 0.8 V to 3.6 V
- Dropout Voltage: 75 mV at 3 A
- Programmable Soft Start
- Open Drain Power Good Output
- Excellent Transient Response
- Current Limit and Thermal Shutdown Protection
- These Devices are Pb-Free and are RoHS Compliant

Applications

- Telecom and Industrial Equipment Point of Load Regulation
- FPGA, DSP and Logic Power Supplies
- Switching Power Supply Post Regulation
- Applications with Specific Start-up Time or Sequencing Requirements

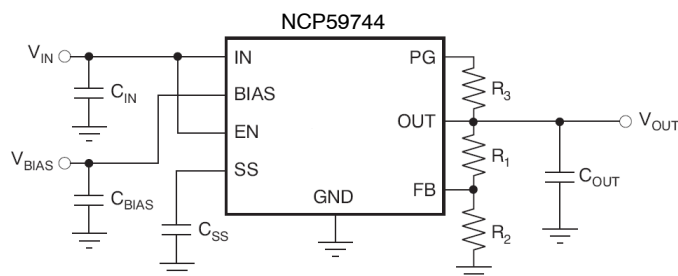
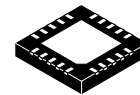

Figure 1. Typical Application Schematic



QFN20
CASE 485DB



DFN10
CASE 485C

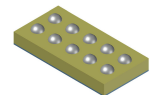

WLCSP10
CASE 567ZC

MARKING DIAGRAMS

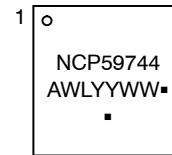

QFN20

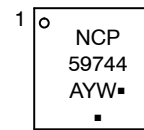

DFN10

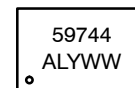

WLCSP10

- A = Assembly Location
- WL = Wafer Lot
- YY, Y = Year
- WW, W = Work Week
- = Pb-Free Package

(Note: Microdot may be in either location)

ORDERING INFORMATION

See detailed ordering, marking and shipping information on page 13 of this data sheet.

NOTE: Some of the devices on this data sheet have been **DISCONTINUED**. Please refer to the table on page 13.

NCP59744

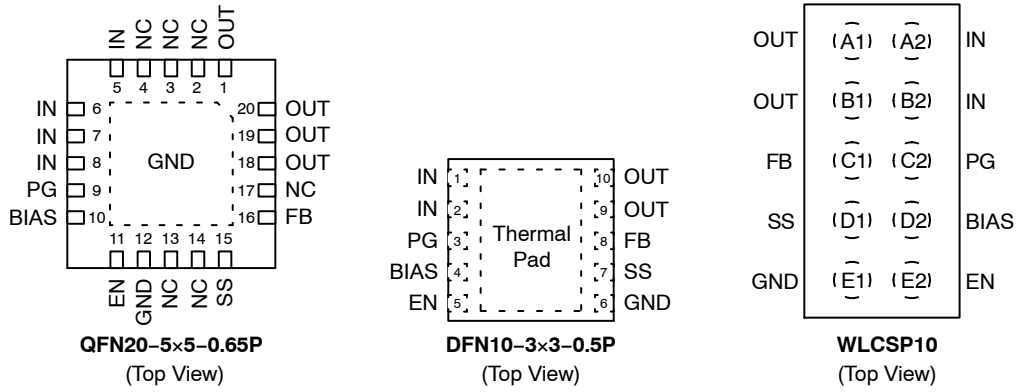

Figure 2. Pin Connections

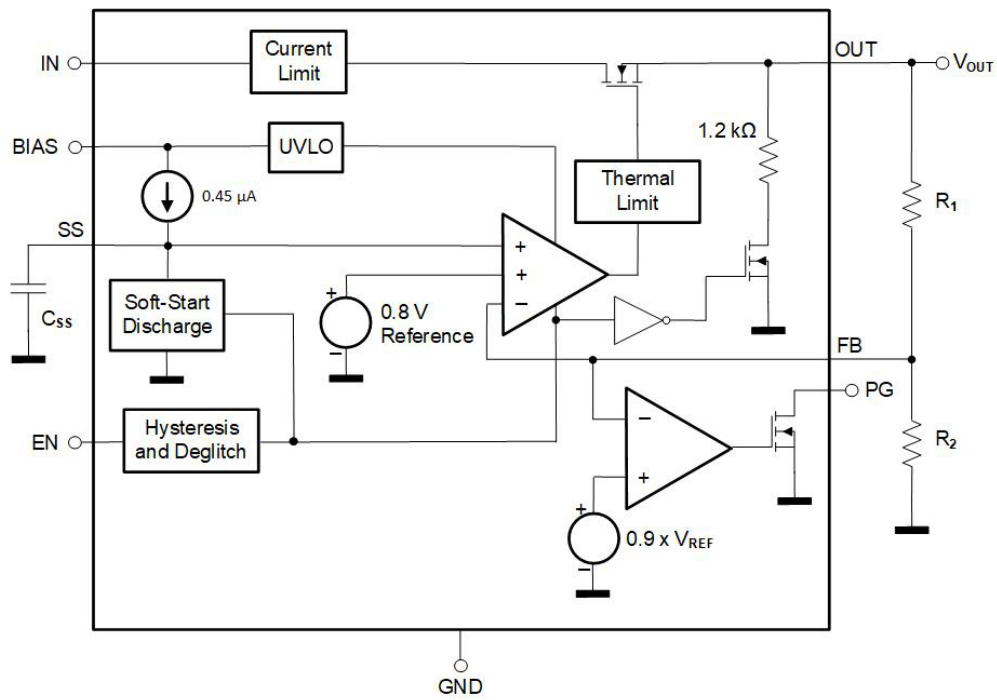

Figure 3. Simplified Schematic Block Diagram

NCP59744

Table 1. PIN FUNCTION DESCRIPTION

| Name | DFN10 | QFN20 | WLCSP10 | Description |
|---------|-------|-----------------|---------|---|
| IN | 1, 2 | 5–8 | A2, B2 | Unregulated input to the device. |
| EN | 5 | 11 | E2 | Enable pin. Driving this pin high enables the regulator. Driving this pin low puts the regulator into shutdown mode. This pin must not be left floating. |
| SS | 7 | 15 | D1 | Soft-Start pin. A capacitor connected on this pin to ground sets the start-up time. If this pin is left floating, the regulator output soft-start ramp time is typically 200 μ s. |
| BIAS | 4 | 10 | D2 | Bias input voltage for error amplifier, reference, and internal control circuits. |
| PG | 3 | 9 | C2 | Power-Good (PG) is an open-drain, active-high output that indicates the status of V_{OUT} . When V_{OUT} exceeds the PG trip threshold, the PG pin goes into a high-impedance state. When V_{OUT} is below this threshold the pin is driven to a low-impedance state. A pull-up resistor from 10 k Ω to 1 M Ω should be connected from this pin to a supply up to 5.5 V. The supply can be higher than the input voltage. Alternatively, the PG pin can be left floating if output monitoring is not necessary. |
| FB | 8 | 16 | C1 | This pin is the feedback connection to the center tap of an external resistor divider network that sets the output voltage. This pin must not be left floating. |
| OUT | 9, 10 | 1, 18–20 | A1, B1 | Regulated output voltage. It is recommended that the output capacitor $\geq 2.2 \mu$ F. |
| NC | N/A | 2–4, 13, 14, 17 | N/A | No connection. This pin can be left floating or connected to GND to allow better thermal contact to the top-side plane. |
| GND | 6 | 12 | E1 | Ground |
| PAD/TAB | | | | Should be soldered to the ground plane for increased thermal performance |

Table 2. ABSOLUTE MAXIMUM RATINGS

| Parameter | Symbol | Value | Unit |
|---|-------------|---|--------------|
| Input Voltage Range | V_{IN} | -0.3 to +6 | V |
| Input Voltage Range | V_{BIAS} | -0.3 to +6 | V |
| Enable Voltage Range | V_{EN} | -0.3 to +6 | V |
| Power-Good Voltage Range | V_{PG} | -0.3 to +6 | V |
| PG Sink Current | I_{PG} | 0 to +1.5 | mA |
| SS Pin Voltage Range | V_{SS} | -0.3 to +6 | V |
| Feedback Pin Voltage Range | V_{FB} | -0.3 to +6 | V |
| Output Voltage Range | V_{OUT} | -0.3 to $(V_{IN} + 0.3) \leq 6$ | V |
| Maximum Output Current | I_{OUT} | Internally Limited | |
| Output Short Circuit Duration | | Indefinite | |
| Continuous Total Power Dissipation | P_D | See Thermal Characteristics Table and Formula | |
| Maximum Junction Temperature | T_{JMAX} | +150 | $^{\circ}$ C |
| Storage Junction Temperature Range | T_{STG} | -55 to +150 | $^{\circ}$ C |
| ESD Capability, Human Body Model (Note 2) | ESD_{HBM} | 2000 | V |
| ESD Capability, Machine Model (Note 2) | ESD_{MM} | 200 | V |

Stresses exceeding those listed in the Maximum Ratings table may damage the device. If any of these limits are exceeded, device functionality should not be assumed, damage may occur and reliability may be affected.

1. Refer to ELECTRICAL CHARACTERISTICS and APPLICATION INFORMATION for Safe Operating Area.
2. This device series incorporates ESD protection and is tested by the following methods:
 ESD Human Body Model tested per EIA/JESD22-A114
 ESD Machine Model tested per EIA/JESD22-A115
 Latch-up Current Maximum Rating tested per JEDEC standard: JESD78.

NCP59744

Table 3. THERMAL CHARACTERISTICS

| Rating | Symbol | Value | Unit |
|--|-----------------|-------|------|
| Thermal Characteristics, DFN10, 3x3, 0.5P package | | | |
| Thermal Resistance, Junction-to-Ambient (Note 5) | $R_{\theta JA}$ | 41.5 | °C/W |
| Thermal Resistance, Junction-to-Case (bottom) (Note 7) | $R_{\theta JC}$ | 6.6 | °C/W |
| Thermal Characteristics, QFN20, 5x5, 0.65P package | | | |
| Thermal Resistance, Junction-to-Ambient (Note 5) | $R_{\theta JA}$ | 35.4 | °C/W |
| Thermal Resistance, Junction-to-Board (Note 6) | $R_{\theta JB}$ | 14.7 | °C/W |
| Thermal Resistance, Junction-to-Case (bottom) (Note 7) | $R_{\theta JC}$ | 3.9 | °C/W |
| Thermal Characteristics, WLCSP10 package | | | |
| Thermal Resistance, Junction-to-Ambient (Note 5) | $R_{\theta JA}$ | 72 | °C/W |
| Thermal Characterization Parameter, Junction-to-Case (top) | Ψ_{JT} | 0.9 | °C/W |

3. Refer to ELECTRICAL CHARACTERISTICS and APPLICATION INFORMATION for Safe Operating Area.
4. Thermal data are derived by thermal simulations based on methodology specified in the JEDEC JESD51 series standards. The following assumptions are used in the simulations:
 - These data were generated with only a single device at the center of a high-K (2s2p) board with 3 in x 3 in copper area which follows the JEDEC51.7 guidelines. Top and Bottom layer 2 oz. copper, inner planes 1 oz. copper.
 - DFN10: The exposed pad is connected to the PCB ground inner layer through a 3x2 thermal via array. Vias are 0.3 mm diameter, plated. Each of top and bottom copper layers are assumed to have thermal conductivity representing 20% copper coverage.
 - QFN20: The exposed pad is connected to the PCB ground inner layer through a 4x4 thermal via array. Vias are 0.3 mm diameter, plated. Each of top and bottom copper layers has a dedicated pattern for 20% copper coverage.
5. The junction-to-ambient thermal resistance under natural convection is obtained in a simulation on a high-K board, following the JEDEC51.7 guidelines with assumptions as above, in an environment described in JESD51-2a.
6. The junction-to-board thermal resistance is simulated in an environment with a ring cold plate fixture to control the PCB temperature, as described in JESD51-8.
7. The junction-to-case (bottom) thermal resistance is obtained by simulating a cold plate test on the IC exposed pad. Test description can be found in the ANSI SEMI standard G30-88.

Table 4. RECOMMENDED OPERATING CONDITIONS (Note 8)

| Rating | Symbol | Min | Max | Unit |
|----------------------|------------|--------------------|-----|------|
| Input Voltage | V_{IN} | $V_{OUT} + V_{DO}$ | 5.5 | V |
| Bias Voltage | V_{BIAS} | 2.2 | 5.5 | V |
| Junction Temperature | T_J | -40 | 125 | °C |

Functional operation above the stresses listed in the Recommended Operating Ranges is not implied. Extended exposure to stresses beyond the Recommended Operating Ranges limits may affect device reliability.

8. Refer to ELECTRICAL CHARACTERISTICS and APPLICATION INFORMATION for Safe Operating Area.

NCP59744

Table 5. ELECTRICAL CHARACTERISTICS – NCP59744FCTCADJT2G – WLCSP10

(At $V_{EN} = 1.1\text{ V}$, $V_{IN} = V_{OUT} + 0.3\text{ V}$, $C_{BIAS} = C_{IN} = 0.1\ \mu\text{F}$, $C_{OUT} = 10\ \mu\text{F}$, $I_{OUT} = 50\text{ mA}$, $V_{BIAS} = 5.0\text{ V}$, $T_J = -40^\circ\text{C}$ to $+125^\circ\text{C}$, unless otherwise noted. Typical values are at $T_J = +25^\circ\text{C}$.)

| Symbol | Parameter | Test Conditions | Min | Typ | Max | Unit |
|-------------------|--|---|--------------------|---------------------|----------|------------------|
| V_{IN} | Input voltage range | | $V_{OUT} + V_{DO}$ | | 5.5 | V |
| V_{BIAS} | Bias pin voltage range | | 2.2 | | 5.5 | V |
| UVLO | Undervoltage Lock-out | V_{BIAS} Rising Hysteresis | 1.2 – | 1.6 0.4 | 1.9 – | V |
| V_{REF} | Internal reference (Adj.) | $T_J = +25^\circ\text{C}$ | 0.796 | 0.8 | 0.804 | V |
| V_{OUT} | Output voltage range | $V_{IN} = 5\text{ V}$, $I_{OUT} = 1.5\text{ A}$, $V_{BIAS} = 5\text{ V}$ | V_{REF} | | 3.6 | V |
| | Accuracy (Note 9) | $2.97\text{ V} \leq V_{BIAS} \leq 5.25\text{ V}$, $V_{OUT} + 1.62\text{ V} \leq V_{BIAS}$ $50\text{ mA} \leq I_{OUT} \leq 3.0\text{ A}$ | –1.0 | ± 0.25 | +1.0 | % |
| V_{OUT}/V_{IN} | Line regulation | $V_{OUT(NOM)} + 0.3 \leq V_{IN} \leq 5.5\text{ V}$ | | 0.0006 | | %/V |
| V_{OUT}/I_{OUT} | Load regulation | $0\text{ mA} \leq I_{OUT} \leq 50\text{ mA}$ | | 0.005 | | %/mA |
| | | $50\text{ mA} \leq I_{OUT} \leq 3.0\text{ A}$ | | 0.01 | | %/A |
| V_{DO} | V_{IN} dropout voltage (Note 10) | $I_{OUT} = 3.0\text{ A}$, $V_{BIAS} - V_{OUT(NOM)} \geq 1.62\text{ V}$ | | 75 | 140 | mV |
| | V_{BIAS} dropout voltage (Note 10) | $I_{OUT} = 3.0\text{ A}$, $V_{IN} = V_{BIAS}$ | | 1.13 | 1.5 | V |
| I_{CL} | Current limit | $V_{OUT} = 80\% \times V_{OUT(NOM)}$ | 3.8 | 4.6 | 7 | A |
| I_{BIAS} | Bias pin current | $0\text{ mA} \leq I_{OUT} \leq 3.0\text{ A}$ | | 1.3 | 2 | mA |
| I_{SHDN} | Shutdown supply current | $V_{EN} \leq 0.4\text{ V}$ | | 1 | 15 | μA |
| I_{FB} | Feedback pin current | $0\text{ mA} \leq I_{OUT} \leq 3.0\text{ A}$ | –250 | 95 | 250 | nA |
| PSRR | Power-supply rejection (V_{IN} to V_{OUT}) | 1 kHz, $I_{OUT} = 1.5\text{ A}$, $V_{IN} = 1.8\text{ V}$, $V_{OUT} = 1.5\text{ V}$ | | 72 | | dB |
| | | 1 MHz, $I_{OUT} = 1.5\text{ A}$, $V_{IN} = 1.8\text{ V}$, $V_{OUT} = 1.5\text{ V}$ | | 50 | | |
| | Power-supply rejection (V_{BIAS} to V_{OUT}) | 1 kHz, $I_{OUT} = 1.5\text{ A}$, $V_{IN} = 1.8\text{ V}$, $V_{OUT} = 1.5\text{ V}$ | | 80 | | dB |
| | | 1 MHz, $I_{OUT} = 1.5\text{ A}$, $V_{IN} = 1.8\text{ V}$, $V_{OUT} = 1.5\text{ V}$ | | 48 | | |
| Noise | Output noise voltage | 100 Hz to 100 kHz, $I_{OUT} = 3\text{ A}$ $C_{SS} = 1.0\text{ nF}$ | | $18 \times V_{OUT}$ | | μVrms |
| V_{TRAN} | % V_{OUT} droop during load transient | $I_{OUT} = 50\text{ mA}$ to 3.0 A at $1\text{ A}/\mu\text{s}$, $C_{OUT} = 10\ \mu\text{F}$, $V_{OUT} = 3.3\text{ V}$ | | ± 1.5 | | % V_{OUT} |
| t_{STRT} | Minimum startup time | $I_{OUT} = 1.5\text{ A}$, $C_{SS} = \text{open}$ | | 200 | | μs |
| I_{SS} | Soft-start charging current | $V_{SS} = 0.4\text{ V}$ | | 0.45 | | μA |
| $V_{EN, HI}$ | Enable input high level | | 1.1 | | 5.5 | V |
| $V_{EN, LO}$ | Enable input low level | | 0 | | 0.4 | V |
| $V_{EN, HYS}$ | Enable pin hysteresis | | | 100 | | mV |
| $V_{EN, DG}$ | Enable pin deglitch time | | | 20 | | μs |
| I_{EN} | Enable pin current | $V_{EN} = 5\text{ V}$ | | 0.3 | 1 | μA |
| V_{IT} | PG trip threshold | V_{OUT} decreasing | 86.5 | 90 | 93.5 | % V_{OUT} |
| V_{HYS} | PG trip hysteresis | | | 3 | | % V_{OUT} |
| $V_{PG, LO}$ | PG output low voltage | $I_{PG} = 1\text{ mA}$ (sinking), $V_{OUT} < V_{IT}$ | | | 0.3 | V |
| $I_{PG, LKG}$ | PG leakage current | $V_{PG} = 5.25\text{ V}$, $V_{OUT} > V_{IT}$ | | 0.03 | 1 | μA |
| TSD | Thermal shutdown temperature | Shutdown, temperature increasing Reset, temperature decreasing | | +165 +140 | | $^\circ\text{C}$ |

Product parametric performance is indicated in the Electrical Characteristics for the listed test conditions, unless otherwise noted. Product performance may not be indicated by the Electrical Characteristics if operated under different conditions.

9. Adjustable devices tested at 0.8 V; external resistor tolerance is not taken into account.

10. Dropout is defined as the voltage from the input to V_{OUT} when V_{OUT} is 2% below nominal.

NCP59744

Table 6. ELECTRICAL CHARACTERISTICS – NCP59744MN1ADJTBG – DFN10

(At $V_{EN} = 1.1\text{ V}$, $V_{IN} = V_{OUT} + 0.3\text{ V}$, $C_{BIAS} = C_{IN} = 0.1\ \mu\text{F}$, $C_{OUT} = 10\ \mu\text{F}$, $I_{OUT} = 50\text{ mA}$, $V_{BIAS} = 5.0\text{ V}$, $T_J = -40^\circ\text{C}$ to $+125^\circ\text{C}$, unless otherwise noted. Typical values are at $T_J = +25^\circ\text{C}$.)

| Symbol | Parameter | Test Conditions | Min | Typ | Max | Unit |
|-------------------|--|---|--------------------|---------------------|----------|------------------|
| V_{IN} | Input voltage range | | $V_{OUT} + V_{DO}$ | | 5.5 | V |
| V_{BIAS} | Bias pin voltage range | | 2.2 | | 5.5 | V |
| UVLO | Undervoltage Lock-out | V_{BIAS} Rising Hysteresis | 1.2 – | 1.6 0.4 | 1.9 – | V |
| V_{REF} | Internal reference (Adj.) | $T_J = +25^\circ\text{C}$ | 0.796 | 0.8 | 0.804 | V |
| V_{OUT} | Output voltage range | $V_{IN} = 5\text{ V}$, $I_{OUT} = 1.5\text{ A}$, $V_{BIAS} = 5\text{ V}$ | V_{REF} | | 3.6 | V |
| | Accuracy (Note 11) | $2.97\text{ V} \leq V_{BIAS} \leq 5.25\text{ V}$, $V_{OUT} + 1.62\text{ V} \leq V_{BIAS}$ $50\text{ mA} \leq I_{OUT} \leq 3.0\text{ A}$ | –1.0 | ± 0.25 | +1.0 | % |
| V_{OUT}/V_{IN} | Line regulation | $V_{OUT(NOM)} + 0.3 \leq V_{IN} \leq 5.5\text{ V}$ | | 0.0006 | | %/V |
| V_{OUT}/I_{OUT} | Load regulation | $0\text{ mA} \leq I_{OUT} \leq 50\text{ mA}$ | | 0.005 | | %/mA |
| | | $50\text{ mA} \leq I_{OUT} \leq 3.0\text{ A}$ | | 0.01 | | %/A |
| V_{DO} | V_{IN} dropout voltage (Note 12) | $I_{OUT} = 3.0\text{ A}$, $V_{BIAS} - V_{OUT(NOM)} \geq 1.62\text{ V}$ | | 95 | 160 | mV |
| | V_{BIAS} dropout voltage (Note 12) | $I_{OUT} = 3.0\text{ A}$, $V_{IN} = V_{BIAS}$ | | 1.13 | 1.5 | V |
| I_{CL} | Current limit | $V_{OUT} = 80\% \times V_{OUT(NOM)}$ | 3.8 | 4.6 | 7 | A |
| I_{BIAS} | Bias pin current | $0\text{ mA} \leq I_{OUT} \leq 3.0\text{ A}$ | | 1.3 | 2 | mA |
| I_{SHDN} | Shutdown supply current | $V_{EN} \leq 0.4\text{ V}$ | | 1 | 15 | μA |
| I_{FB} | Feedback pin current | $0\text{ mA} \leq I_{OUT} \leq 3.0\text{ A}$ | –250 | 95 | 250 | nA |
| PSRR | Power-supply rejection (V_{IN} to V_{OUT}) | 1 kHz, $I_{OUT} = 1.5\text{ A}$, $V_{IN} = 1.8\text{ V}$, $V_{OUT} = 1.5\text{ V}$ | | 72 | | dB |
| | | 1 MHz, $I_{OUT} = 1.5\text{ A}$, $V_{IN} = 1.8\text{ V}$, $V_{OUT} = 1.5\text{ V}$ | | 50 | | |
| | Power-supply rejection (V_{BIAS} to V_{OUT}) | 1 kHz, $I_{OUT} = 1.5\text{ A}$, $V_{IN} = 1.8\text{ V}$, $V_{OUT} = 1.5\text{ V}$ | | 80 | | dB |
| | | 1 MHz, $I_{OUT} = 1.5\text{ A}$, $V_{IN} = 1.8\text{ V}$, $V_{OUT} = 1.5\text{ V}$ | | 48 | | |
| Noise | Output noise voltage | 100 Hz to 100 kHz, $I_{OUT} = 3\text{ A}$ $C_{SS} = 1.0\text{ nF}$ | | $18 \times V_{OUT}$ | | μVrms |
| V_{TRAN} | % V_{OUT} droop during load transient | $I_{OUT} = 50\text{ mA}$ to 3.0 A at $1\text{ A}/\mu\text{s}$, $C_{OUT} = 10\ \mu\text{F}$, $V_{OUT} = 3.3\text{ V}$ | | ± 1.5 | | % V_{OUT} |
| t_{STRT} | Minimum startup time | $I_{OUT} = 1.5\text{ A}$, $C_{SS} = \text{open}$ | | 200 | | μs |
| I_{SS} | Soft-start charging current | $V_{SS} = 0.4\text{ V}$ | | 0.45 | | μA |
| $V_{EN, HI}$ | Enable input high level | | 1.1 | | 5.5 | V |
| $V_{EN, LO}$ | Enable input low level | | 0 | | 0.4 | V |
| $V_{EN, HYS}$ | Enable pin hysteresis | | | 100 | | mV |
| $V_{EN, DG}$ | Enable pin deglitch time | | | 20 | | μs |
| I_{EN} | Enable pin current | $V_{EN} = 5\text{ V}$ | | 0.3 | 1 | μA |
| V_{IT} | PG trip threshold | V_{OUT} decreasing | 86.5 | 90 | 93.5 | % V_{OUT} |
| V_{HYS} | PG trip hysteresis | | | 3 | | % V_{OUT} |
| $V_{PG, LO}$ | PG output low voltage | $I_{PG} = 1\text{ mA}$ (sinking), $V_{OUT} < V_{IT}$ | | | 0.3 | V |
| $I_{PG, LKG}$ | PG leakage current | $V_{PG} = 5.25\text{ V}$, $V_{OUT} > V_{IT}$ | | 0.03 | 1 | μA |
| TSD | Thermal shutdown temperature | Shutdown, temperature increasing Reset, temperature decreasing | | +165 +140 | | $^\circ\text{C}$ |

Product parametric performance is indicated in the Electrical Characteristics for the listed test conditions, unless otherwise noted. Product performance may not be indicated by the Electrical Characteristics if operated under different conditions.

11. Adjustable devices tested at 0.8 V; external resistor tolerance is not taken into account.

12. Dropout is defined as the voltage from the input to V_{OUT} when V_{OUT} is 2% below nominal.

NCP59744

Table 7. ELECTRICAL CHARACTERISTICS – NCP59744MN2ADJTBG – QFN20

(At $V_{EN} = 1.1\text{ V}$, $V_{IN} = V_{OUT} + 0.3\text{ V}$, $C_{BIAS} = C_{IN} = 0.1\ \mu\text{F}$, $C_{OUT} = 10\ \mu\text{F}$, $I_{OUT} = 50\text{ mA}$, $V_{BIAS} = 5.0\text{ V}$, $T_J = -40^\circ\text{C}$ to $+125^\circ\text{C}$, unless otherwise noted. Typical values are at $T_J = +25^\circ\text{C}$.)

| Symbol | Parameter | Test Conditions | Min | Typ | Max | Unit | |
|-------------------|--|---|--------------------|---------------------|----------|------------------|----|
| V_{IN} | Input voltage range | | $V_{OUT} + V_{DO}$ | | 5.5 | V | |
| V_{BIAS} | Bias pin voltage range | | 2.2 | | 5.5 | V | |
| UVLO | Undervoltage Lock-out | V_{BIAS} Rising Hysteresis | 1.2 – | 1.6 0.4 | 1.9 – | V | |
| V_{REF} | Internal reference (Adj.) | $T_J = +25^\circ\text{C}$ | 0.796 | 0.8 | 0.804 | V | |
| V_{OUT} | Output voltage range | $V_{IN} = 5\text{ V}$, $I_{OUT} = 1.5\text{ A}$, $V_{BIAS} = 5\text{ V}$ | V_{REF} | | 3.6 | V | |
| | Accuracy (Note 13) | $2.97\text{ V} \leq V_{BIAS} \leq 5.25\text{ V}$, $V_{OUT} + 1.62\text{ V} \leq V_{BIAS}$ $50\text{ mA} \leq I_{OUT} \leq 3.0\text{ A}$ | –1.0 | ± 0.25 | +1.0 | % | |
| V_{OUT}/V_{IN} | Line regulation | $V_{OUT(NOM)} + 0.3 \leq V_{IN} \leq 5.5\text{ V}$ | | 0.0006 | | %/V | |
| V_{OUT}/I_{OUT} | Load regulation | $0\text{ mA} \leq I_{OUT} \leq 50\text{ mA}$ | | 0.005 | | %/mA | |
| | | $50\text{ mA} \leq I_{OUT} \leq 3.0\text{ A}$ | | 0.01 | | %/A | |
| V_{DO} | V_{IN} dropout voltage (Note 14) | $I_{OUT} = 3.0\text{ A}$, $V_{BIAS} - V_{OUT(NOM)} \geq 1.62\text{ V}$ | | 115 | 195 | mV | |
| | V_{BIAS} dropout voltage (Note 14) | $I_{OUT} = 3.0\text{ A}$, $V_{IN} = V_{BIAS}$ | | 1.13 | 1.5 | V | |
| I_{CL} | Current limit | $V_{OUT} = 80\% \times V_{OUT(NOM)}$ | 3.8 | 4.6 | 6 | A | |
| I_{BIAS} | Bias pin current | $0\text{ mA} \leq I_{OUT} \leq 3.0\text{ A}$ | | 1.3 | 2 | mA | |
| I_{SHDN} | Shutdown supply current | $V_{EN} \leq 0.4\text{ V}$ | | 1 | 10 | μA | |
| I_{FB} | Feedback pin current | $0\text{ mA} \leq I_{OUT} \leq 3.0\text{ A}$ | –250 | 95 | 250 | nA | |
| PSRR | Power-supply rejection (V_{IN} to V_{OUT}) | 1 kHz, $I_{OUT} = 1.5\text{ A}$, $V_{IN} = 1.8\text{ V}$, $V_{OUT} = 1.5\text{ V}$ | | 72 | | dB | |
| | | 1 MHz, $I_{OUT} = 1.5\text{ A}$, $V_{IN} = 1.8\text{ V}$, $V_{OUT} = 1.5\text{ V}$ | | 50 | | | |
| | Power-supply rejection (V_{BIAS} to V_{OUT}) | 1 kHz, $I_{OUT} = 1.5\text{ A}$, $V_{IN} = 1.8\text{ V}$, $V_{OUT} = 1.5\text{ V}$ | | | 80 | | dB |
| | | 1 MHz, $I_{OUT} = 1.5\text{ A}$, $V_{IN} = 1.8\text{ V}$, $V_{OUT} = 1.5\text{ V}$ | | | 48 | | |
| Noise | Output noise voltage | 100 Hz to 100 kHz, $I_{OUT} = 3\text{ A}$ $C_{SS} = 1.0\text{ nF}$ | | $18 \times V_{OUT}$ | | μVrms | |
| V_{TRAN} | % V_{OUT} droop during load transient | $I_{OUT} = 50\text{ mA}$ to 3.0 A at $1\text{ A}/\mu\text{s}$, $C_{OUT} = 10\ \mu\text{F}$, $V_{OUT} = 3.3\text{ V}$ | | ± 1.5 | | % V_{OUT} | |
| t_{STRT} | Minimum startup time | $I_{OUT} = 1.5\text{ A}$, $C_{SS} = \text{open}$ | | 200 | | μs | |
| I_{SS} | Soft-start charging current | $V_{SS} = 0.4\text{ V}$ | | 0.45 | | μA | |
| $V_{EN, HI}$ | Enable input high level | | 1.1 | | 5.5 | V | |
| $V_{EN, LO}$ | Enable input low level | | 0 | | 0.4 | V | |
| $V_{EN, HYS}$ | Enable pin hysteresis | | | 100 | | mV | |
| $V_{EN, DG}$ | Enable pin deglitch time | | | 20 | | μs | |
| I_{EN} | Enable pin current | $V_{EN} = 5\text{ V}$ | | 0.3 | 1 | μA | |
| V_{IT} | PG trip threshold | V_{OUT} decreasing | 86.5 | 90 | 93.5 | % V_{OUT} | |
| V_{HYS} | PG trip hysteresis | | | 3 | | % V_{OUT} | |
| $V_{PG, LO}$ | PG output low voltage | $I_{PG} = 1\text{ mA}$ (sinking), $V_{OUT} < V_{IT}$ | | | 0.3 | V | |
| $I_{PG, LKG}$ | PG leakage current | $V_{PG} = 5.25\text{ V}$, $V_{OUT} > V_{IT}$ | | 0.03 | 1 | μA | |
| TSD | Thermal shutdown temperature | Shutdown, temperature increasing Reset, temperature decreasing | | +165 +140 | | $^\circ\text{C}$ | |

Product parametric performance is indicated in the Electrical Characteristics for the listed test conditions, unless otherwise noted. Product performance may not be indicated by the Electrical Characteristics if operated under different conditions.

13. Adjustable devices tested at 0.8 V; external resistor tolerance is not taken into account.

14. Dropout is defined as the voltage from the input to V_{OUT} when V_{OUT} is 2% below nominal.

TYPICAL CHARACTERISTICS

At $T_J = +25^\circ\text{C}$, $V_{OUT} = 1.5\text{ V}$, $V_{IN} = V_{OUT(TYP)} + 0.3\text{ V}$, $V_{BIAS} = 3.3\text{ V}$, $I_{OUT} = 50\text{ mA}$, $V_{EN} = V_{IN}$,
 $C_{IN} = 1\ \mu\text{F}$, $C_{BIAS} = 1\ \mu\text{F}$, $C_{SS} = 0.01\ \mu\text{F}$, and $C_{OUT} = 10\ \mu\text{F}$, unless otherwise noted.

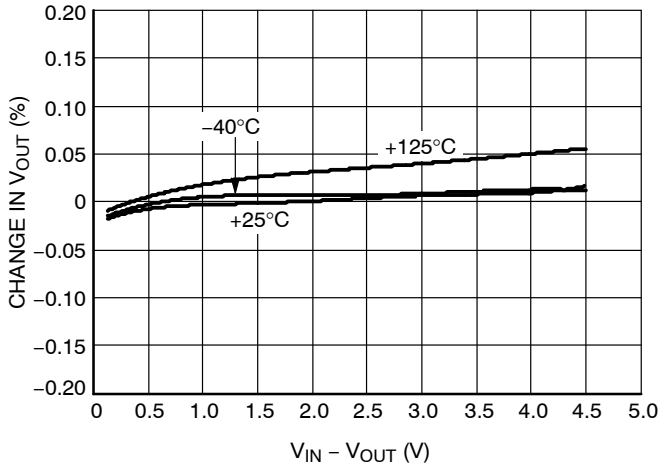

Figure 4. V_{IN} Line Regulation

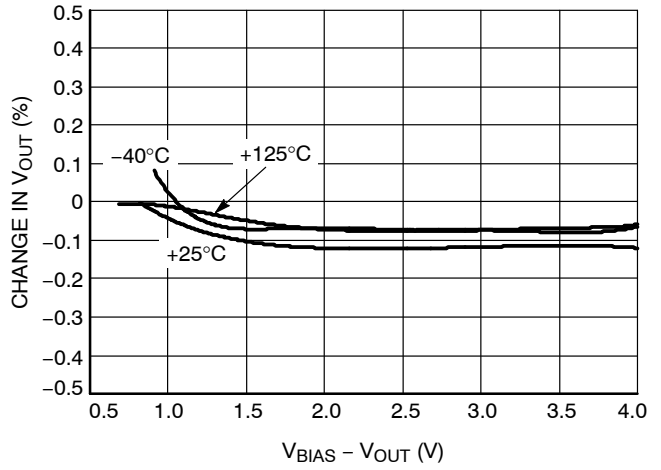

Figure 5. V_{BIAS} Line Regulation

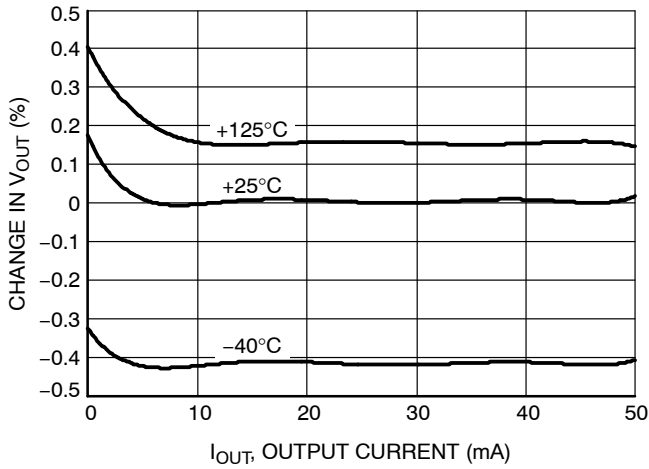

Figure 6. Load Regulation

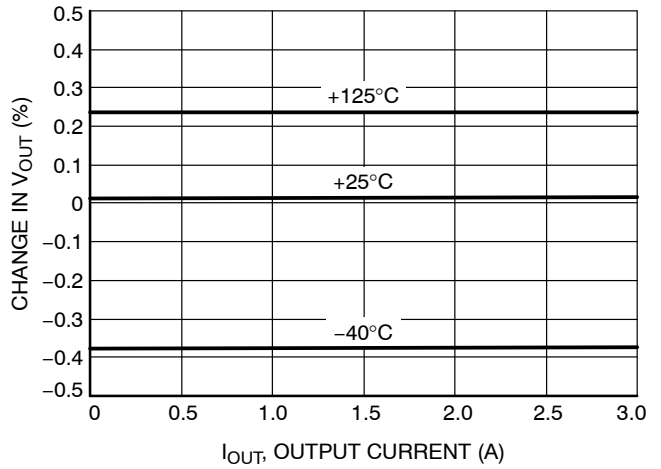

Figure 7. Load Regulation

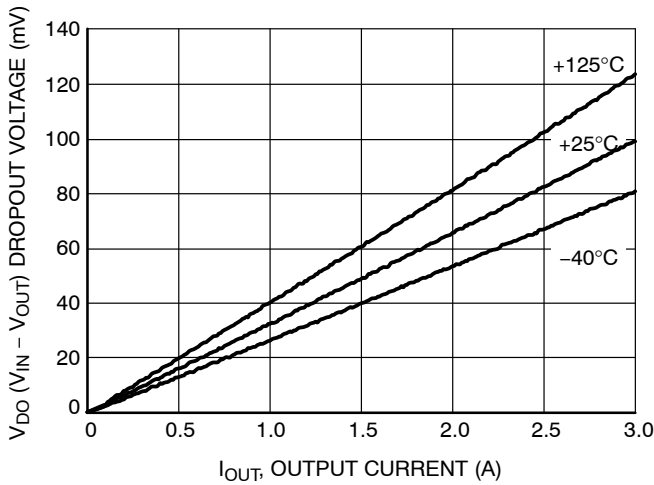

Figure 8. V_{IN} Dropout Voltage vs. I_{OUT} and Temperature T_J

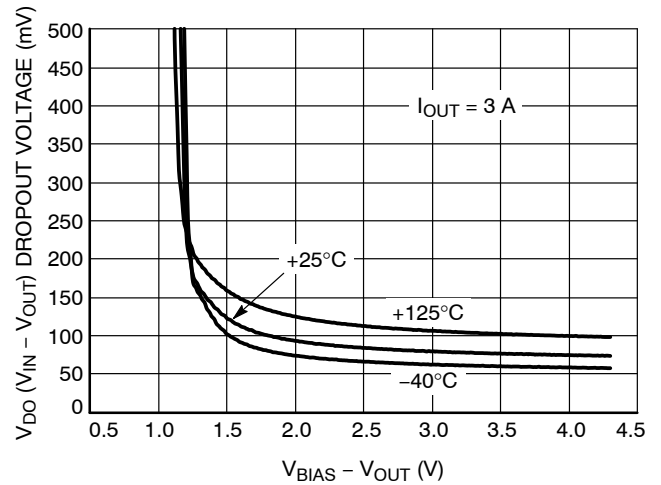

Figure 9. V_{IN} Dropout Voltage vs. $(V_{BIAS} - V_{OUT})$ and Temperature T_J

TYPICAL CHARACTERISTICS

At $T_J = +25^\circ\text{C}$, $V_{OUT} = 1.5\text{ V}$, $V_{IN} = V_{OUT(TYP)} + 0.3\text{ V}$, $V_{BIAS} = 3.3\text{ V}$, $I_{OUT} = 50\text{ mA}$, $V_{EN} = V_{IN}$, $C_{IN} = 1\ \mu\text{F}$, $C_{BIAS} = 1\ \mu\text{F}$, $C_{SS} = 0.01\ \mu\text{F}$, and $C_{OUT} = 10\ \mu\text{F}$, unless otherwise noted.

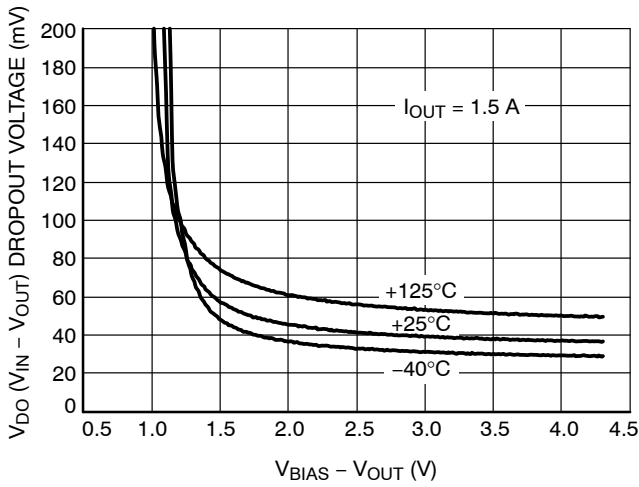

Figure 10. V_{IN} Dropout Voltage vs. ($V_{BIAS} - V_{OUT}$) and Temperature T_J

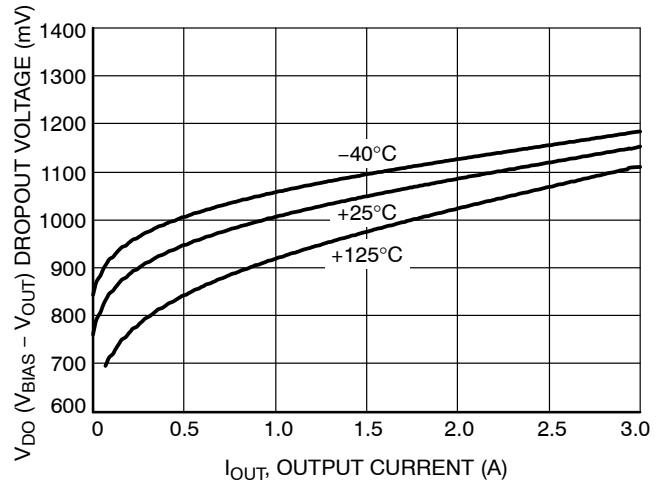

Figure 11. V_{BIAS} Dropout Voltage vs. I_{OUT} and Temperature T_J

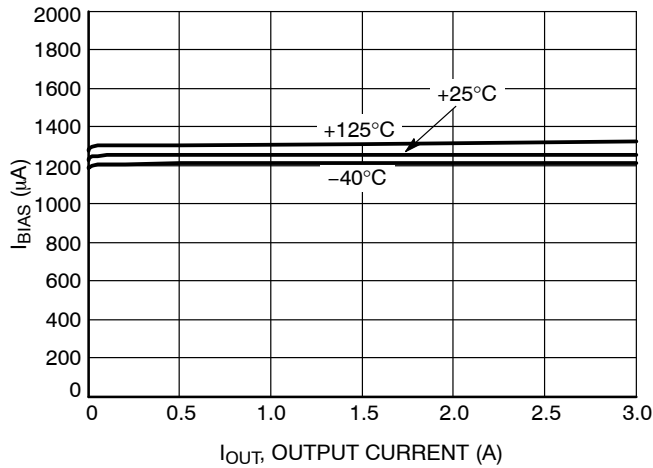

Figure 12. BIAS Pin Current vs. I_{OUT} and Temperature T_J

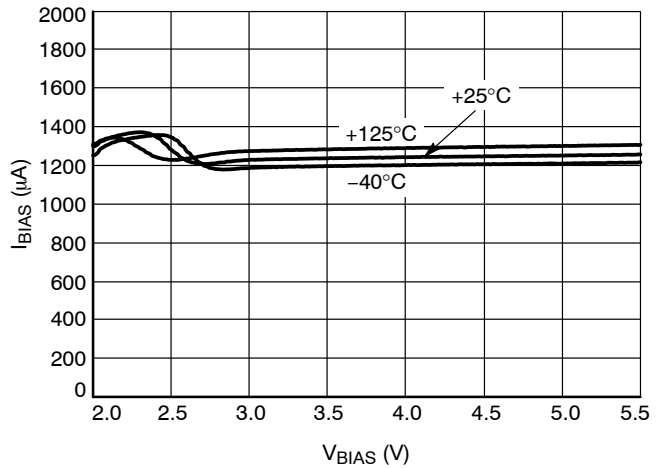

Figure 13. BIAS Pin Current vs. V_{BIAS} and Temperature T_J

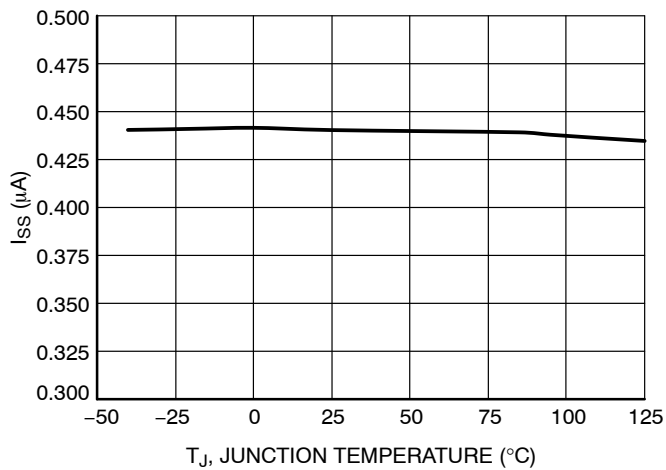

Figure 14. Soft Start Charging Current I_{SS} vs. Temperature T_J

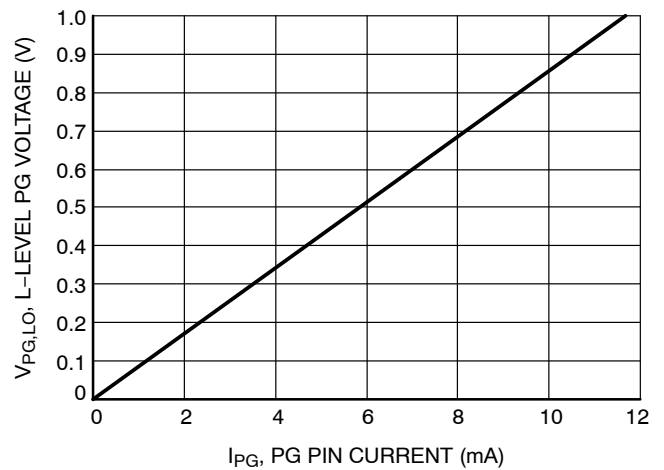

Figure 15. L-level PG Voltage vs. Current

TYPICAL CHARACTERISTICS

At $T_J = +25^\circ\text{C}$, $V_{OUT} = 1.5\text{ V}$, $V_{IN} = V_{OUT(TYP)} + 0.3\text{ V}$, $V_{BIAS} = 3.3\text{ V}$, $I_{OUT} = 50\text{ mA}$, $V_{EN} = V_{IN}$, $C_{IN} = 1\ \mu\text{F}$, $C_{BIAS} = 1\ \mu\text{F}$, $C_{SS} = 0.01\ \mu\text{F}$, and $C_{OUT} = 10\ \mu\text{F}$, unless otherwise noted.

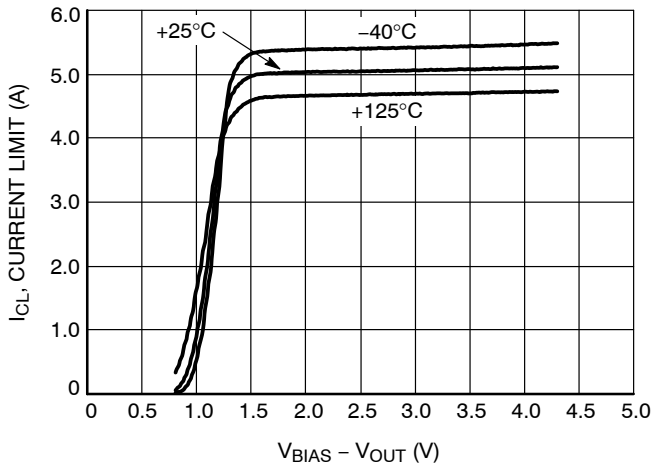

Figure 16. Current Limit vs. ($V_{BIAS} - V_{OUT}$)

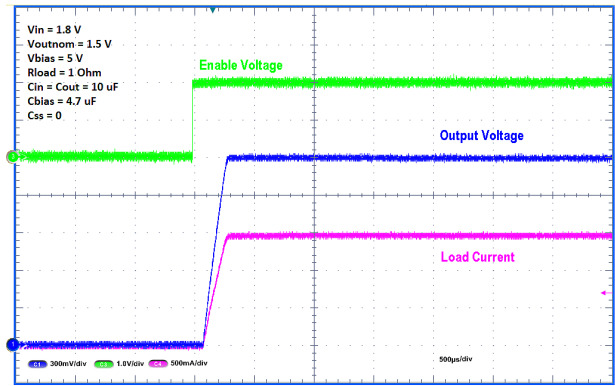

Figure 17. Start by Enable at $C_{SS} = 0$

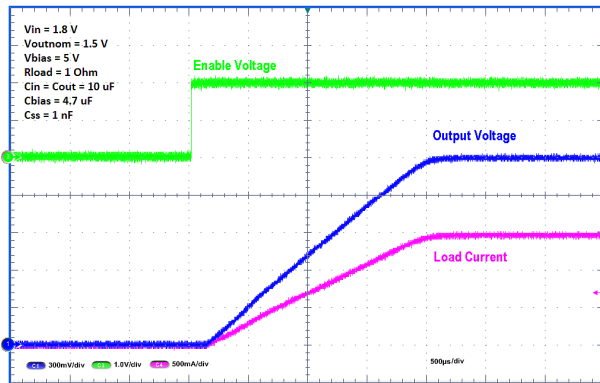

Figure 18. Start by Enable at $C_{SS} = 1\text{ nF}$

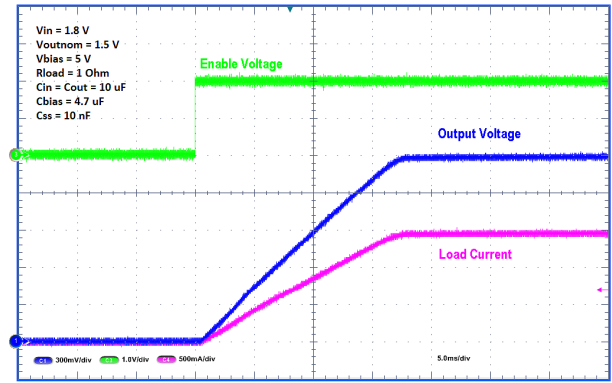

Figure 19. Start by Enable at $C_{SS} = 10\text{ nF}$

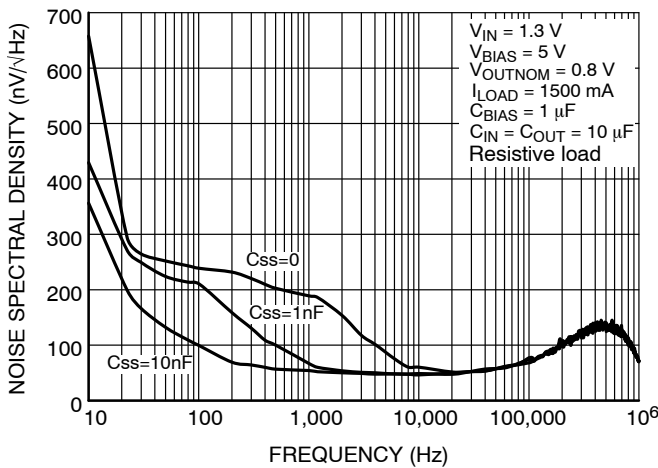

Figure 20. Output Voltage Noise Spectral Density at $V_{OUT} = 0.8\text{ V}$

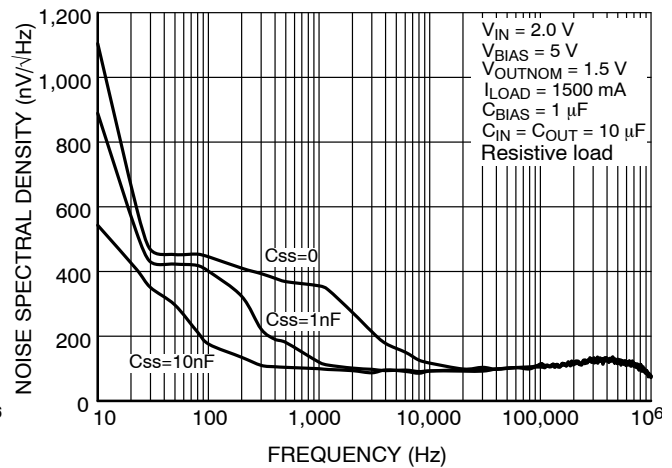

Figure 21. Output Voltage Noise Spectral Density at $V_{OUT} = 1.5\text{ V}$

TYPICAL CHARACTERISTICS

At $T_J = +25^\circ\text{C}$, $V_{OUT} = 1.5\text{ V}$, $V_{IN} = V_{OUT(TYP)} + 0.3\text{ V}$, $V_{BIAS} = 3.3\text{ V}$, $I_{OUT} = 50\text{ mA}$, $V_{EN} = V_{IN}$,
 $C_{IN} = 1\ \mu\text{F}$, $C_{BIAS} = 1\ \mu\text{F}$, $C_{SS} = 0.01\ \mu\text{F}$, and $C_{OUT} = 10\ \mu\text{F}$, unless otherwise noted.

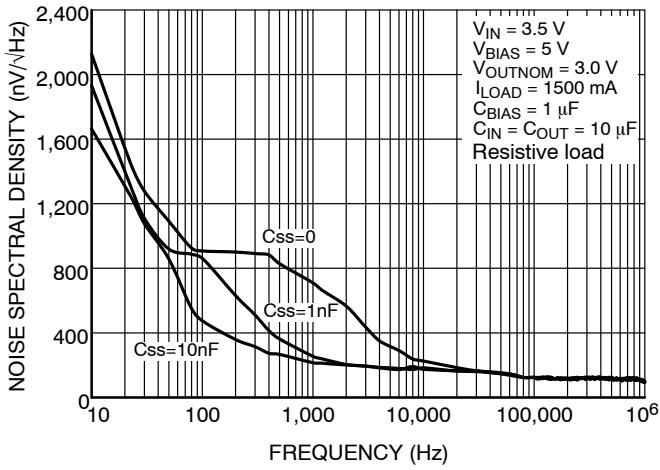

Figure 22. Output Voltage Noise Spectral Density at $V_{OUT} = 3.0\text{ V}$

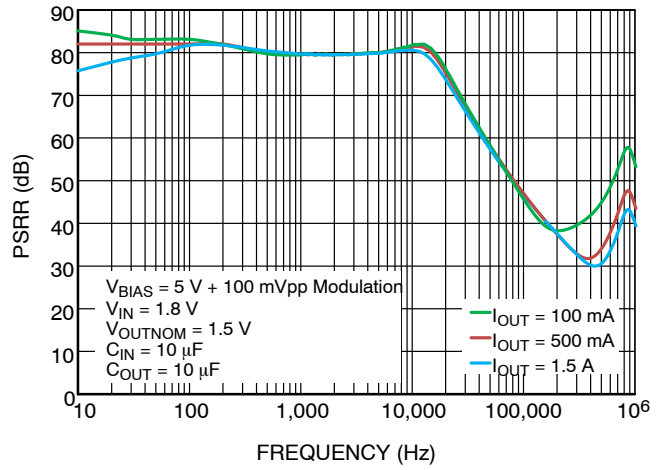

Figure 23. V_{BIAS} PSRR

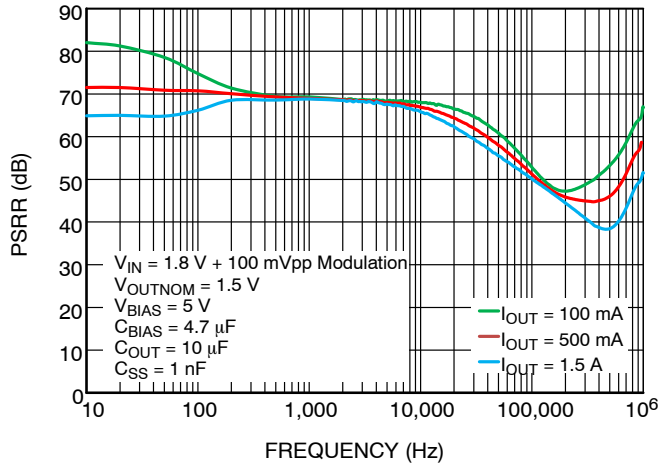

Figure 24. V_{IN} PSRR

APPLICATIONS INFORMATION

The NCP59744 dual-rail very low dropout voltage regulator is using NMOS pass transistor for output voltage regulation from V_{IN} voltage. All the low current internal control circuitry is powered from the V_{BIAS} voltage.

The use of an NMOS pass transistor offers several advantages in applications. Unlike a PMOS topology devices, the output capacitor has reduced impact on loop stability. V_{in} to V_{out} operating voltage difference can be very low compared with standard PMOS regulators in very low V_{in} applications.

The NCP59744 offers programmable smooth monotonic start-up. The controlled voltage rising limits the inrush current what is advantageous in applications with large capacitive loads. The Voltage Controlled Soft Start timing is programmable by external C_{SS} capacitor value.

The Enable (EN) input is equipped with internal hysteresis and deglitch filter.

Open Drain type Power Good (PG) output is available for V_{out} monitoring and sequencing of other devices.

NCP59744 is a Adjustable linear regulator. The required Output voltage can be adjusted by two external resistors. Typical application schematics is shown in Figure 25.

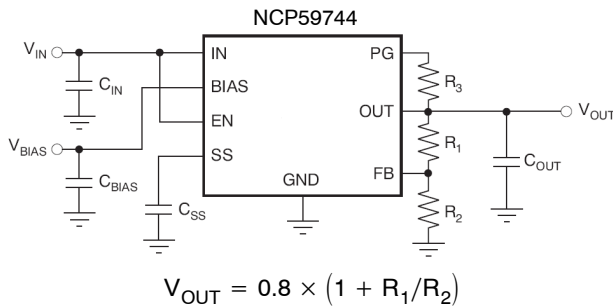

Figure 25. Typical Application Schematics

Dropout Voltage

Because of two power supply inputs V_{IN} and V_{BIAS} and one V_{OUT} regulator output, there are two Dropout voltages specified.

The first, the V_{IN} Dropout voltage is the voltage difference ($V_{IN} - V_{OUT}$) when V_{OUT} starts to decrease by percents specified in the Electrical Characteristics table. V_{BIAS} is high enough, specific value is published in the Electrical Characteristics table.

The second, V_{BIAS} dropout voltage is the voltage difference ($V_{BIAS} - V_{OUT}$) when V_{IN} and V_{BIAS} pins are joined together and V_{OUT} starts to decrease.

Input and Output Capacitors

The device is designed to be stable for all available types and values of output capacitors $\geq 2.2 \mu F$. The device is also stable with multiple capacitors in parallel, which can be of any type or value.

In applications where no low input supply impedance is available (PCB inductance in V_{in} and/or V_{bias} inputs as an example) the recommended C_{in} and C_{bias} value is $1 \mu F$ or

greater. In order to avoid any excessive input voltage transients caused i.e. by a sudden output short circuit conditions the input capacitor value should be sized properly for each particular application to counteract any input inductance. For V_{in} of 5.5 V the recommended input capacitance is $22 \mu F$ or greater. Ceramic or other low ESR capacitors are recommended. For the best performance all capacitors should be connected to the NCP59744 respective pins directly in the device PCB copper layer, not through vias having not negligible impedance.

Enable Operation

The enable pin will turn the regulator on or off. The threshold limits are covered in the electrical characteristics table in this data sheet. If the enable function is not to be used then the pin should be connected to V_{IN} or V_{BIAS} .

To get the full functionality of Soft-Start, it is recommended to turn on the V_{IN} and V_{BIAS} supply voltages first and activate the Enable pin no sooner than when V_{IN} and V_{BIAS} are on their nominal levels.

The NCP59744 device is equipped with Output Active Discharge transistor that is pulling the output to GND through a $1.2 k\Omega$ (typ.) resistor when the device is disabled.

Output Noise

When the NCP59744 device reaches the end of the Soft-Start cycle, the Soft Start capacitor is switched to serve as a Noise filtering capacitor.

Output Voltage Adjust

The output voltage can be adjusted from 0.8 V to 3.6 V using resistors divider between the output and the FB input. Recommended resistor values for frequently used voltages can be found in the Table 8.

Programmable Soft-Start

The Soft-Start ramp time depends on the Soft Start charging current I_{SS} , Soft-Start capacitor value C_{SS} and internal reference voltage V_{REF} .

The Soft -Start time can be calculated using following equations:

$$t_{ss} = C_{SS} \times (V_{REF} / I_{SS}) [s, F, V, A]$$

or in more practical units

$$t_{ss} = C_{SS} \times 0.8V / 0.45 = C_{SS} \times 1.78$$

where

t_{ss} = Soft-Start time in milliseconds

C_{SS} = Soft-Start capacitor value in nano Farads

Capacitor values for frequently used Soft-Start times can be found in the Table 9.

The maximal recommended value of C_{SS} capacitor is 15 nF. For higher C_{SS} values the capacitor full discharging before new Soft-Start cycle is not guaranteed.

NCP59744

Power Good

Power–Good (PG) is an open–drain, active–high output that indicates the status of V_{OUT} . When V_{OUT} exceeds the PG trip threshold, the PG pin goes into a high–impedance state. When V_{OUT} is below this threshold the pin is driven to a low–impedance state. A pull–up resistor from 10 k Ω to 1 M Ω should be connected from this pin to a supply up to 5.5 V. The supply can be higher than the input voltage. Alternatively, the PG pin can be left floating if output monitoring is not necessary.

Current Limitation

The internal Current Limitation circuitry allows the device to supply the full nominal current and surges but protects the device against Current Overload or Short.

Thermal Protection

Internal thermal shutdown (TSD) circuitry is provided to protect the integrated circuit in the event that the maximum junction temperature is exceeded. When TSD activated, the regulator output turns off. When cooling down under the low temperature threshold, device output is activated again. This

TSD feature is provided to prevent failures from accidental overheating.

Table 8. RESISTOR VALUES FOR PROGRAMMING THE OUTPUT VOLTAGE

| V_{OUT} (V) | R_1 (k Ω) | R_2 (k Ω) |
|---------------|---------------------|---------------------|
| 0.8 | Short | Open |
| 0.9 | 0.619 | 4.99 |
| 1.0 | 1.13 | 4.53 |
| 1.05 | 1.37 | 4.33 |
| 1.1 | 1.87 | 4.99 |
| 1.2 | 2.49 | 4.99 |
| 1.5 | 4.12 | 4.75 |
| 1.8 | 3.57 | 2.87 |
| 2.5 | 3.57 | 1.69 |
| 3.3 | 3.57 | 1.15 |

NOTE: $V_{OUT} = 0.8 \times (1 + R_1/R_2)$
Resistors in the table are standard 1% types

Table 9. CAPACITOR VALUES FOR PROGRAMMING THE SOFT–START TIME

| Soft–Start Time | C_{SS} |
|-----------------|----------|
| 0.2 ms | Open |
| 0.5 ms | 270 pF |
| 1 ms | 560 pF |

| | |
|-------|--------|
| 5 ms | 2.7 nF |
| 10 ms | 5.6 nF |
| 18 ms | 10 nF |

Table 10. ORDERING INFORMATION

| Device | Output Current | Output Voltage | Junction Temp. Range | Package | Shipping [†] |
|-------------------|----------------|----------------|----------------------|-----------------|-----------------------|
| NCP59744MN1ADJTBG | 3.0 A | ADJ | –40°C to +125°C | DFN10 (Pb–Free) | 3000 / Tape & Reel |
| NCP59744MN2ADJTBG | 3.0 A | ADJ | –40°C to +125°C | QFN20 (Pb–Free) | 3000 / Tape & Reel |

DISCONTINUED (Note 15)

| | | | | | |
|--------------------|-------|-----|-----------------|-------------------|--------------------|
| NCP59744FCTCADJT2G | 3.0 A | ADJ | –40°C to +125°C | WLCSP10 (Pb–Free) | 5000 / Tape & Reel |
|--------------------|-------|-----|-----------------|-------------------|--------------------|

[†]For information on tape and reel specifications, including part orientation and tape sizes, please refer to our Tape and Reel Packaging Specifications Brochure, BRD8011/D.

15. **DISCONTINUED:** This device is not recommended for new design. Please contact your **onsemi** representative for information. The most current information on this device may be available on www.onsemi.com.

MECHANICAL CASE OUTLINE PACKAGE DIMENSIONS



SCALE 2:1

DFN10, 3x3, 0.5P CASE 485C ISSUE F

DATE 16 DEC 2021

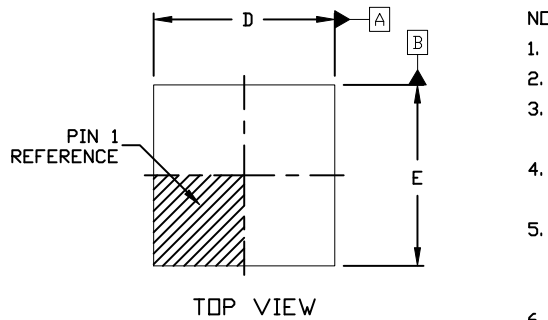

NOTES:

1. DIMENSION AND TOLERANCING PER ASME Y14.5, 2009.
2. CONTROLLING DIMENSION: MILLIMETERS
3. DIMENSION *b* APPLIES TO PLATED TERMINAL AND IS MEASURED BETWEEN 0.15 AND 0.30 MM FROM THE TERMINAL TIP.
4. COPLANARITY APPLIES TO THE EXPOSED PAD AS WELL AS THE TERMINALS.
5. TERMINAL *b* MAY HAVE MOLD COMPOUND MATERIAL ALONG SIDE EDGE. MOLD FLASH MAY NOT EXCEED 30 MICRONS ONTO BOTTOM SURFACE OF TERMINAL.
6. FOR DEVICE OPN CONTAINING W OPTION, DETAIL A AND DETAIL B ALTERNATE CONSTRUCTIONS ARE NOT APPLICABLE. WETTABLE FLANK CONSTRUCTION IS DETAIL B AS SHOWN ON SIDE VIEW OF PACKAGE.

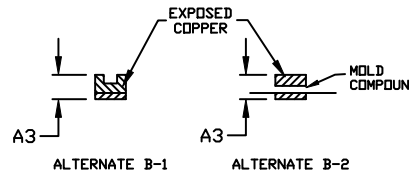
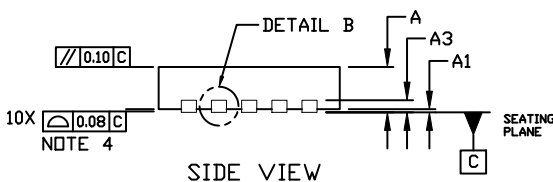

| DIM | MILLIMETERS | | |
|----------|-------------|------|------|
| | MIN. | NOM. | MAX. |
| A | 0.80 | 0.90 | 1.00 |
| A1 | 0.00 | --- | 0.05 |
| A3 | 0.20 REF | | |
| <i>b</i> | 0.18 | 0.23 | 0.30 |
| D | 2.90 | 3.00 | 3.10 |
| D2 | 2.40 | 2.50 | 2.60 |
| E | 2.90 | 3.00 | 3.10 |
| E2 | 1.70 | 1.80 | 1.90 |
| <i>e</i> | 0.50 BSC | | |
| K | 0.20 REF | | |
| L | 0.30 | 0.40 | 0.50 |
| L1 | --- | --- | 0.03 |

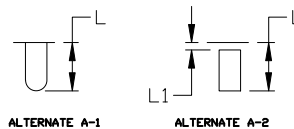
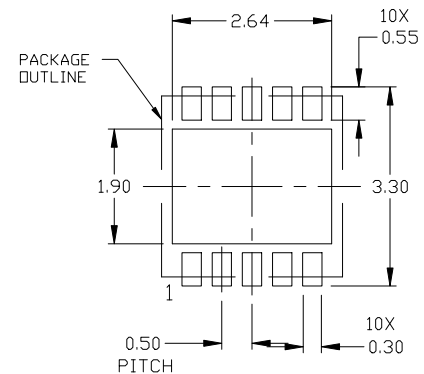
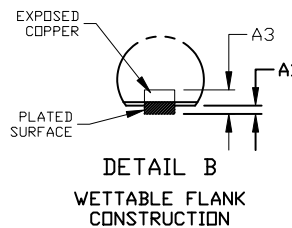
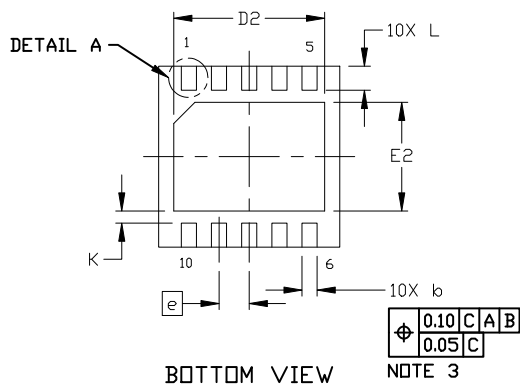

GENERIC MARKING DIAGRAM*

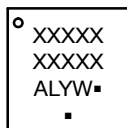

- XXXXX = Specific Device Code
- A = Assembly Location
- L = Wafer Lot
- Y = Year
- W = Work Week
- = Pb-Free Package

(Note: Microdot may be in either location)

*This information is generic. Please refer to device data sheet for actual part marking. Pb-Free indicator, "G" or microdot "▪", may or may not be present. Some products may not follow the Generic Marking.

RECOMMENDED MOUNTING FOOTPRINT

For additional information on our Pb-Free strategy and soldering details, please download the ON Semiconductor Soldering and Mounting Techniques Reference Manual, SOLDERRM/D.

| | | |
|-------------------------|------------------------------------|--|
| DOCUMENT NUMBER: | 98AON03161D | Electronic versions are uncontrolled except when accessed directly from the Document Repository. Printed versions are uncontrolled except when stamped "CONTROLLED COPY" in red. |
| DESCRIPTION: | DFN10, 3X3 MM, 0.5 MM PITCH | PAGE 1 OF 1 |

onsemi and ONSEMI are trademarks of Semiconductor Components Industries, LLC dba onsemi or its subsidiaries in the United States and/or other countries. onsemi reserves the right to make changes without further notice to any products herein. onsemi makes no warranty, representation or guarantee regarding the suitability of its products for any particular purpose, nor does onsemi assume any liability arising out of the application or use of any product or circuit, and specifically disclaims any and all liability, including without limitation special, consequential or incidental damages. onsemi does not convey any license under its patent rights nor the rights of others.

MECHANICAL CASE OUTLINE

PACKAGE DIMENSIONS

ON Semiconductor®

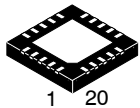

QFN20 5x5, 0.65P
CASE 485DB
ISSUE O

DATE 02 APR 2013

SCALE 2:1

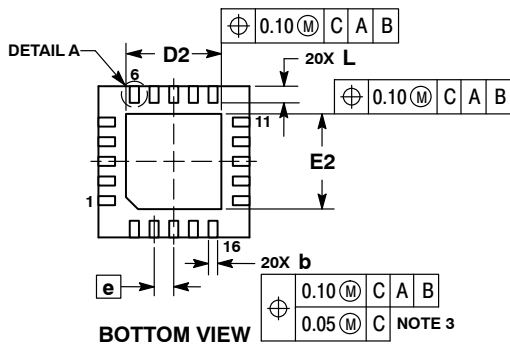
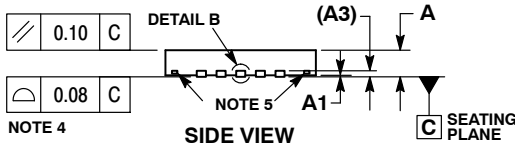
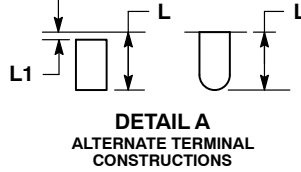
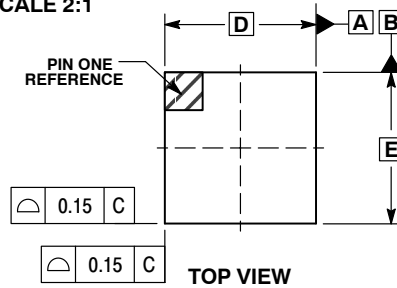

NOTES:

1. DIMENSIONS AND TOLERANCING PER ASME Y14.5M, 1994.
2. CONTROLLING DIMENSION: MILLIMETERS.
3. DIMENSION b APPLIES TO PLATED TERMINAL AND IS MEASURED BETWEEN 0.25 AND 0.30 MM FROM THE TERMINAL TIP.
4. COPLANARITY APPLIES TO THE EXPOSED PAD AS WELL AS THE TERMINALS.
5. OPTIONAL FEATURES.

| MILLIMETERS | | |
|-------------|------|------|
| DIM | MIN | MAX |
| A | 0.80 | 1.00 |
| A1 | --- | 0.05 |
| A3 | 0.20 | REF |
| b | 0.25 | 0.35 |
| D | 5.00 | BSC |
| D2 | 3.05 | 3.25 |
| E | 5.00 | BSC |
| E2 | 3.05 | 3.25 |
| e | 0.65 | BSC |
| L | 0.45 | 0.65 |
| L1 | --- | 0.15 |

GENERIC MARKING DIAGRAM*

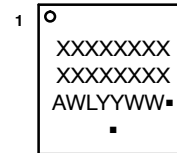

- XXXXX = Specific Device Code
- A = Assembly Location
- WL = Wafer Lot
- YY = Year
- WW = Work Week
- = Pb-Free Package

(Note: Microdot may be in either location)

*This information is generic. Please refer to device data sheet for actual part marking.
Pb-Free indicator, "G" or microdot "▪", may or may not be present.

RECOMMENDED SOLDERING FOOTPRINT*

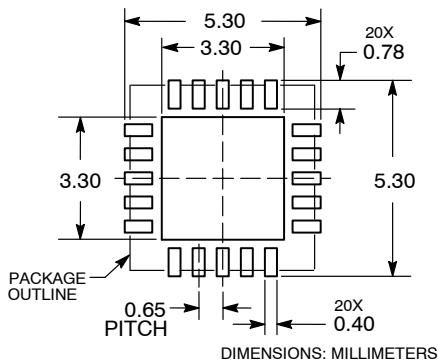

*For additional information on our Pb-Free strategy and soldering details, please download the ON Semiconductor Soldering and Mounting Techniques Reference Manual, SOLDERRM/D.

| | | |
|-------------------------|-------------------------|--|
| DOCUMENT NUMBER: | 98AON88183E | Electronic versions are uncontrolled except when accessed directly from the Document Repository. Printed versions are uncontrolled except when stamped "CONTROLLED COPY" in red. |
| DESCRIPTION: | QFN20 5x5, 0.65P | PAGE 1 OF 1 |

ON Semiconductor and ON are trademarks of Semiconductor Components Industries, LLC dba ON Semiconductor or its subsidiaries in the United States and/or other countries. ON Semiconductor reserves the right to make changes without further notice to any products herein. ON Semiconductor makes no warranty, representation or guarantee regarding the suitability of its products for any particular purpose, nor does ON Semiconductor assume any liability arising out of the application or use of any product or circuit, and specifically disclaims any and all liability, including without limitation special, consequential or incidental damages. ON Semiconductor does not convey any license under its patent rights nor the rights of others.

MECHANICAL CASE OUTLINE

PACKAGE DIMENSIONS

ON Semiconductor®

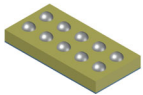

WLCSP10, 2.075x1.025x0.35
CASE 567ZC
ISSUE O

DATE 29 APR 2020

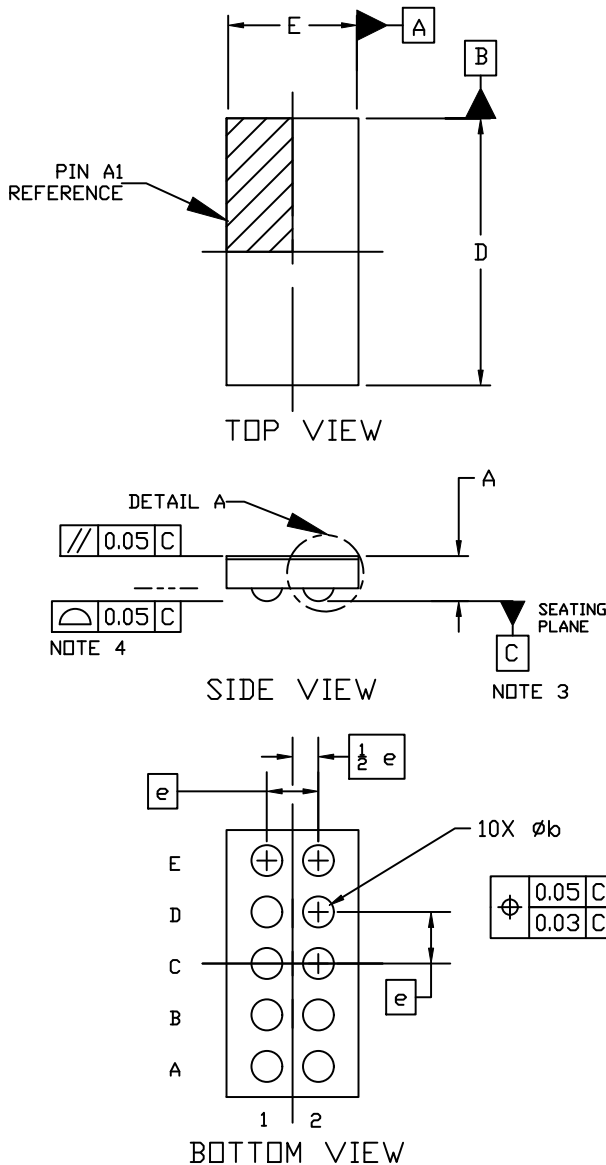

NOTES:

1. DIMENSIONING AND TOLERANCING PER ASME Y14.5M, 2009.
2. CONTROLLING DIMENSION: MILLIMETERS
3. DATUM C, THE SEATING PLANE, IS DEFINED BY THE SPHERICAL CROWNS OF THE CONTACT BALLS.
4. COPLANARITY APPLIES TO THE SPHERICAL CROWNS OF THE CONTACT BALLS.
5. DIMENSION *b* IS MEASURED AT THE MAXIMUM CONTACT BALL DIAMETER PARALLEL TO DATUM C.
6. BACKSIDE COATING, IS OPTIONAL

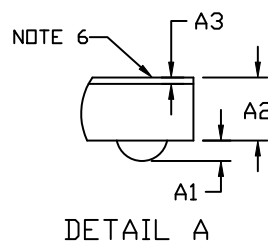

| DIM | MILLIMETERS | | |
|----------|-------------|-------|-------|
| | MIN. | NOM. | MAX. |
| A | 0.310 | 0.350 | 0.390 |
| A1 | 0.080 | 0.100 | 0.120 |
| A2 | 0.25 REF | | |
| A3 | 0.025 REF | | |
| <i>b</i> | 0.22 | 0.24 | 0.26 |
| D | 2.050 | 2.075 | 2.100 |
| E | 1.000 | 1.025 | 1.050 |
| <i>e</i> | 0.40 BSC | | |

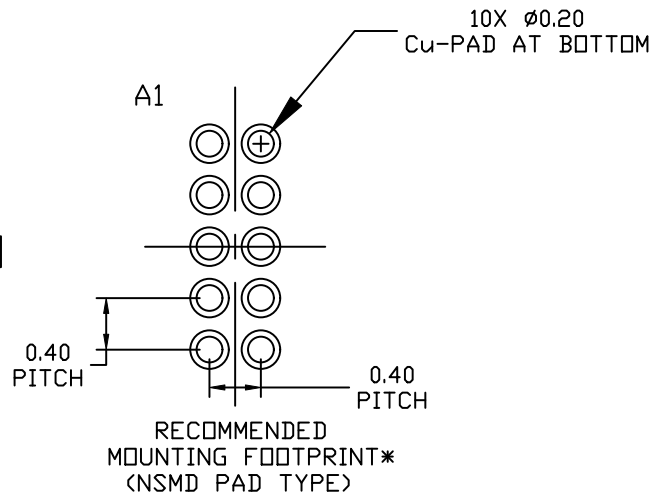

* For additional information on our Pb-Free strategy and soldering details, please download the ON Semiconductor Soldering and Mounting Techniques Reference Manual, SOLDERM/D.

GENERIC MARKING DIAGRAM*

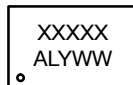

XXXX = Specific Device Code
 A = Assembly Location
 L = Wafer Lot
 Y = Year
 WW = Work Week

*This information is generic. Please refer to device data sheet for actual part marking. Pb-Free indicator, "G", may or not be present. Some products may not follow the Generic Marking.

| | | |
|-------------------------|----------------------------------|--|
| DOCUMENT NUMBER: | 98AON19872H | Electronic versions are uncontrolled except when accessed directly from the Document Repository. Printed versions are uncontrolled except when stamped "CONTROLLED COPY" in red. |
| DESCRIPTION: | WLCSP10, 2.075x1.025x0.35 | PAGE 1 OF 1 |

ON Semiconductor and are trademarks of Semiconductor Components Industries, LLC dba ON Semiconductor or its subsidiaries in the United States and/or other countries. ON Semiconductor reserves the right to make changes without further notice to any products herein. ON Semiconductor makes no warranty, representation or guarantee regarding the suitability of its products for any particular purpose, nor does ON Semiconductor assume any liability arising out of the application or use of any product or circuit, and specifically disclaims any and all liability, including without limitation special, consequential or incidental damages. ON Semiconductor does not convey any license under its patent rights nor the rights of others.

onsemi, **Onsemi**, and other names, marks, and brands are registered and/or common law trademarks of Semiconductor Components Industries, LLC dba "**onsemi**" or its affiliates and/or subsidiaries in the United States and/or other countries. **onsemi** owns the rights to a number of patents, trademarks, copyrights, trade secrets, and other intellectual property. A listing of **onsemi**'s product/patent coverage may be accessed at www.onsemi.com/site/pdf/Patent-Marking.pdf. **onsemi** reserves the right to make changes at any time to any products or information herein, without notice. The information herein is provided "as-is" and **onsemi** makes no warranty, representation or guarantee regarding the accuracy of the information, product features, availability, functionality, or suitability of its products for any particular purpose, nor does **onsemi** assume any liability arising out of the application or use of any product or circuit, and specifically disclaims any and all liability, including without limitation special, consequential or incidental damages. Buyer is responsible for its products and applications using **onsemi** products, including compliance with all laws, regulations and safety requirements or standards, regardless of any support or applications information provided by **onsemi**. "Typical" parameters which may be provided in **onsemi** data sheets and/or specifications can and do vary in different applications and actual performance may vary over time. All operating parameters, including "Typicals" must be validated for each customer application by customer's technical experts. **onsemi** does not convey any license under any of its intellectual property rights nor the rights of others. **onsemi** products are not designed, intended, or authorized for use as a critical component in life support systems or any FDA Class 3 medical devices or medical devices with a same or similar classification in a foreign jurisdiction or any devices intended for implantation in the human body. Should Buyer purchase or use **onsemi** products for any such unintended or unauthorized application, Buyer shall indemnify and hold **onsemi** and its officers, employees, subsidiaries, affiliates, and distributors harmless against all claims, costs, damages, and expenses, and reasonable attorney fees arising out of, directly or indirectly, any claim of personal injury or death associated with such unintended or unauthorized use, even if such claim alleges that **onsemi** was negligent regarding the design or manufacture of the part. **onsemi** is an Equal Opportunity/Affirmative Action Employer. This literature is subject to all applicable copyright laws and is not for resale in any manner.

ADDITIONAL INFORMATION

TECHNICAL PUBLICATIONS:

Technical Library: www.onsemi.com/design/resources/technical-documentation
onsemi Website: www.onsemi.com

ONLINE SUPPORT: www.onsemi.com/support

For additional information, please contact your local Sales Representative at www.onsemi.com/support/sales