

# NCV4290

## 5.0 V, 450 mA Low-Dropout Voltage Regulator with Power Good

The NCV4290 is an integrated low dropout regulator designed for use in harsh automotive environments. It includes wide operating temperature and input voltage ranges. The output is regulated at 5.0 V and is rated to 450 mA of output current. It also provides a number of features, including overcurrent protection, overtemperature protection and a programmable microprocessor power good signal. The NCV4290 is available in the DPAK and D<sup>2</sup>PAK surface mount packages. The output is stable over a wide output capacitance and ESR range.

### Features

- 5.0 V,  $\pm 2\%$  Output Voltage Options
- 450 mA Output Current
- Very Low Current Consumption
- Active Power Good Output
- Power Good Low Down to  $V_Q = 1.0$  V
- 500 mV (max) Dropout Voltage
- Fault Protection
  - ◆ +45 V Peak Transient Voltage
  - ◆ -42 V Reverse Voltage
  - ◆ Short Circuit Protection
  - ◆ Thermal Overload Protection
- AEC-Q100 Qualified
- These are Pb-Free Devices

### Applications

- Auto Body Electronics

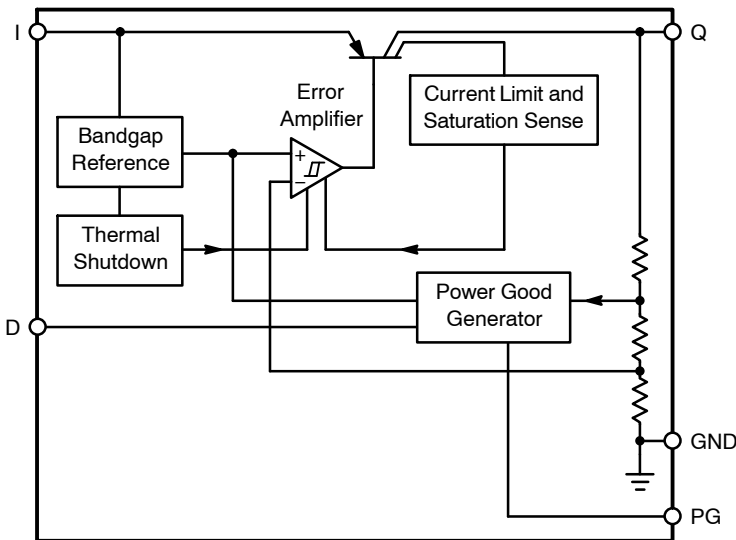

Figure 1. Block Diagram



ON Semiconductor®

<http://onsemi.com>

### MARKING DIAGRAMS

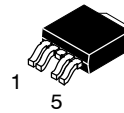

DPAK, 5-PIN  
DT SUFFIX  
CASE 175AA

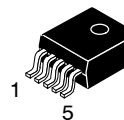
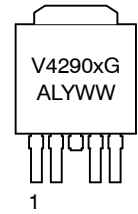

D<sup>2</sup>PAK, 5-PIN  
DS SUFFIX  
CASE 936A

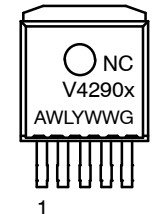

x = 5 (5.0 V Output)  
A = Assembly Location  
WL, L = Wafer Lot  
Y = Year  
WW = Work Week  
G = Pb-Free Package

Pin 1. I  
2. PG  
Tab, 3. GND\*  
4. D  
5. Q

\* Tab is connected to Pin 3 on all packages

### ORDERING INFORMATION

See detailed ordering and shipping information in the dimensions section on page 13 of this data sheet.

# NCV4290

## PIN FUNCTION DESCRIPTION

Pin #	Symbol	Description
1	I	Input; Battery Supply Input Voltage. Bypass to ground with a ceramic capacitor.
2	PG	Power Good Output; Open Collector Active Power Good (accurate when $V_Q > 1.0$ V).
3, Tab	GND	Ground; Pin 3 internally connected to tab.
4	D	Power Good Delay; timing capacitor to GND for Power Good Delay function.
5	Q	Output; $\pm 2.0\%$ , 450 mA output. Bypass with 22 $\mu$ F capacitor, ESR < 4.0 $\Omega$ .

## MAXIMUM RATINGS

Rating	Symbol	Min	Max	Unit	
Input Voltage	$V_I$	-42	45	V	
Input Peak Transient Voltage	$V_I$	-	45	V	
Output Voltage	$V_Q$	-1.0	16	V	
Power Good Output Voltage	$V_{PG}$	-0.3	25	V	
Power Good Output Current	$I_{PG}$	-5.0	5.0	mA	
Power Good Delay Voltage	$V_D$	-0.3	7.0	V	
Power Good Delay Current	$I_D$	-2.0	2.0	mA	
ESD Susceptibility (Note 1)	- Human Body Model - Machine Model - Charge Device Model	$ESD_{HBM}$ $ESD_{MM}$ $ESD_{CDM}$	4.0 200 1000	- - -	kV V V
Junction Temperature	$T_J$	-40	150	$^{\circ}$ C	
Storage Temperature	$T_{stg}$	-55	150	$^{\circ}$ C	

Stresses exceeding Maximum Ratings may damage the device. Maximum Ratings are stress ratings only. Functional operation above the Recommended Operating Conditions is not implied. Extended exposure to stresses above the Recommended Operating Conditions may affect device reliability.

1. This device incorporates ESD protection and is tested by the following methods: ESD Human Body Model tested per AEC-Q100-002, ESD Machine Model tested per AEC-Q100-003, ESD Charged Device Model tested per AEC-Q100-011, Latch-up tested per AEC-Q100-004.

# NCV4290

## OPERATING RANGE

Rating	Symbol	Min	Max	Unit
Input Voltage Operating Range, 5.0 V Option	$V_I$	5.5	42	V
Junction Temperature	$T_J$	-40	150	°C

## LEAD TEMPERATURE SOLDERING REFLOW AND MSL (Note 2)

Rating	Symbol	Min	Max	Unit
Lead Free, 60 sec–150 sec above 217°C	$T_{SLD}$	–	265 Peak	°C
Moisture Sensitivity Level	MSL	1		

2.  $PR_R$  IPC / JEDEC J-STD-020C

## THERMAL CHARACTERISTICS

Characteristic	Test Conditions (Typical Value)		Unit
----------------	---------------------------------	--	------

### DPAK 5-PIN PACKAGE

	0.3 sq. in. Spreader Board (Note 3)	1.2 sq. in. Spreader Board (Note 4)	
Junction-to-Tab ( $R_{\theta JT}$ )	4.5	4.8	°C/W
Junction-to-Ambient ( $R_{\theta JA}$ )	76	53	°C/W

### D<sup>2</sup>PAK 5-PIN PACKAGE

	0.4 sq. in. Spreader Board (Note 5)	1.2 sq. in. Spreader Board (Note 6)	
Junction-to-Tab ( $R_{\theta JT}$ )	3.8	4.1	°C/W
Junction-to-Ambient ( $R_{\theta JA}$ )	60	50	°C/W

3. 1 oz. copper, 0.26 inch<sup>2</sup> (168 mm<sup>2</sup>) copper area, 0.062" thick FR4.
4. 1 oz. copper, 1.14 inch<sup>2</sup> (736 mm<sup>2</sup>) copper area, 0.062" thick FR4.
5. 1 oz. copper, 0.373 inch<sup>2</sup> (241 mm<sup>2</sup>) copper area, 0.062" thick FR4.
6. 1 oz. copper, 1.222 inch<sup>2</sup> (788 mm<sup>2</sup>) copper area, 0.062" thick FR4.

# NCV4290

## ELECTRICAL CHARACTERISTICS ( $V_I = 13.5\text{ V}$ , $C_Q = 22\ \mu\text{F}$ , $\text{ESR} = 1.5\ \Omega$ ; $-40^\circ\text{C} < T_J < 150^\circ\text{C}$ ; unless otherwise noted.)

Characteristic	Symbol	Test Conditions	Min	Typ	Max	Unit
<b>OUTPUT</b>						
Output Voltage (5.0 V Option)	$V_Q$	$100\ \mu\text{A} \leq I_Q \leq 400\ \text{mA}$ $6.0\ \text{V} \leq V_I \leq 28\ \text{V}$	4.9	5.0	5.1	V
Output Voltage (5.0 V Option)	$V_Q$	$100\ \mu\text{A} \leq I_Q \leq 200\ \text{mA}$ $6.0\ \text{V} \leq V_I \leq 40\ \text{V}$	4.9	5.0	5.1	V
Output Current Limitation	$I_Q$	$V_Q = 0.9 \times V_{Q,\text{typ}}$	450	1000	–	mA
Quiescent Current $I_q = I_I - I_Q$	$I_q$	$I_Q = 1.0\ \text{mA}$	–	170	230	$\mu\text{A}$
		$I_Q = 1.0\ \text{mA}$ , $T_J = 25^\circ\text{C}$	–	170	200	$\mu\text{A}$
		$I_Q = 250\ \text{mA}$	–	10	15	mA
		$I_Q = 400\ \text{mA}$	–	23	35	mA
Dropout Voltage (5.0 V Option)	$V_{\text{dr}}$	$I_Q = 300\ \text{mA}$ $V_{\text{dr}} = V_I - V_Q$ (Note 7)	–	250	500	mV
Load Regulation	$\Delta V_Q$	$I_Q = 5.0\ \text{mA}$ to $400\ \text{mA}$	–30	5.0	30	mV
Line Regulation	$\Delta V_Q$	$\Delta V_I = 8.0\ \text{V}$ to $32\ \text{V}$ , $I_Q = 5.0\ \text{mA}$	–15	5.0	15	mV
Power Supply Ripple Rejection	PSRR	$f_r = 100\ \text{Hz}$ , $V_r = 0.5\ V_{\text{pp}}$	–	60	–	dB
Temperature Output Voltage Drift	$dV_Q/dT$	--	–	0.5	–	mV/K

## DELAY TIMING D AND POWER GOOD OUTPUT

PG Switching Threshold (5.0 V Option)	$V_{Q,\text{pgt-i}}$	VQ increasing	4.45	4.65	4.8	V
PG Switching Threshold (5.0 V Option)	$V_{Q,\text{pgt-d}}$	VQ decreasing	3.5	3.65	3.8	V
PG Output Low Voltage	$V_{\text{PG}}$	$R_{\text{ext}} \geq 5.0\ \text{k}\Omega$ , $V_Q \geq 1.0\ \text{V}$	–	0.1	0.4	V
PG Output Leakage Current	$I_{\text{PG}}$	$V_{\text{PGH}} > 4.5\ \text{V}$	–	0	10	$\mu\text{A}$
PG Charging Current	$I_{\text{D,C}}$	$V_{\text{D}} = 1.0\ \text{V}$	3.0	6.0	9.0	$\mu\text{A}$
Upper Timing Threshold	$V_{\text{DU}}$	--	1.5	1.8	2.2	V
Lower Timing Threshold	$V_{\text{DL}}$	--	0.6	0.85	1.1	V
PG Delay Time	$t_{\text{rd}}$	$C_{\text{D}} = 47\ \text{nF}$	10	16	22	ms
PG Reaction Time	$t_{\text{rr}}$	$C_{\text{D}} = 47\ \text{nF}$	0.2	0.75	2.0	$\mu\text{s}$

## THERMAL SHUTDOWN

Shutdown Temperature (Note 8)	$T_{\text{SD}}$	--	150	–	210	$^\circ\text{C}$
-------------------------------	-----------------	----	-----	---	-----	------------------

7. Measured when output voltage  $V_Q$  falls 100 mV below the regulated voltage at  $V_I = 13.5\ \text{V}$ .  $V_{\text{dr}} = V_I - V_Q$ .

8. Guaranteed by design, not tested in production.

TYPICAL PERFORMANCE CHARACTERISTICS

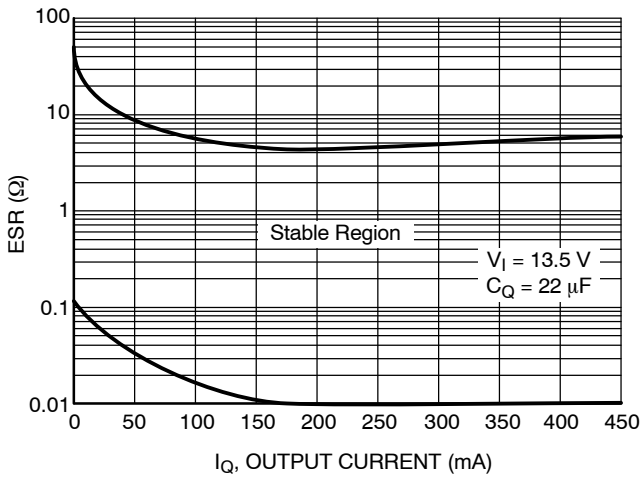

Figure 2. Output Stability with Output Capacitor ESR

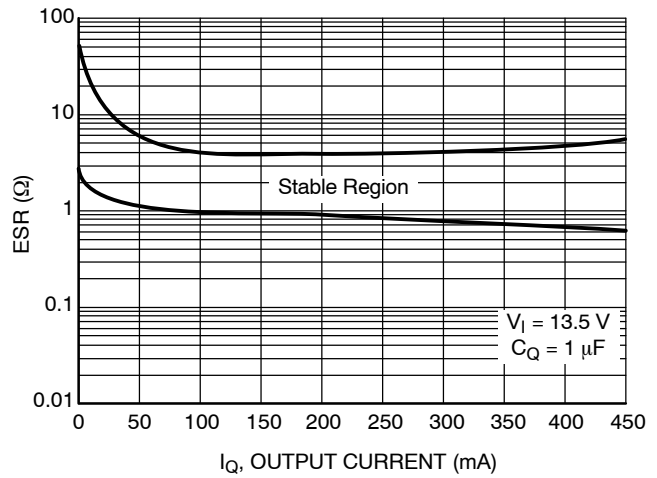

Figure 3. Output Stability with Output Capacitor ESR

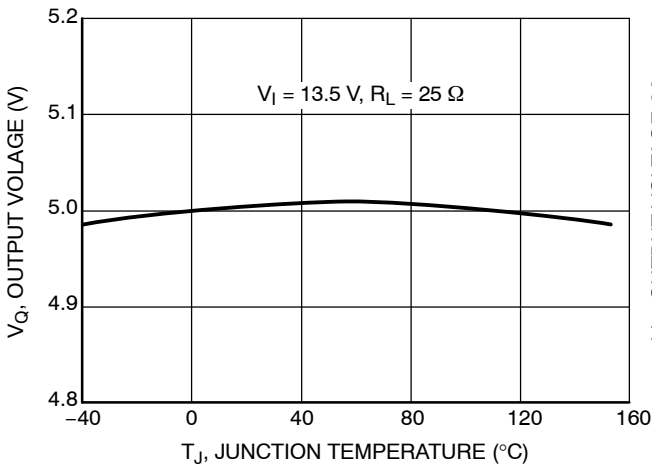

Figure 4. Output Voltage  $V_Q$  vs. Temperature  $T_J$

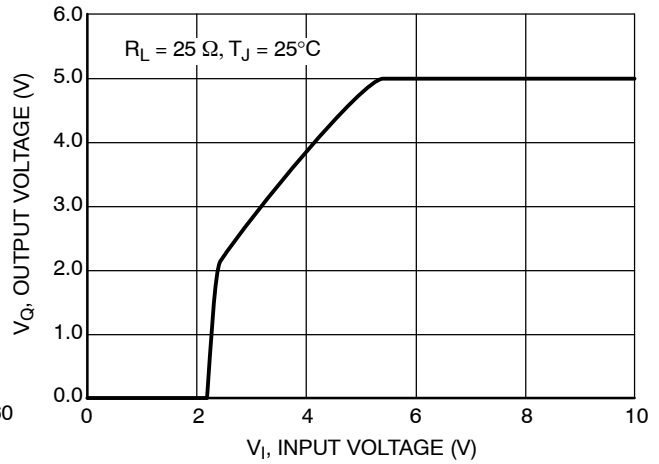

Figure 5. Output Voltage  $V_Q$  vs. Input Voltage  $V_I$

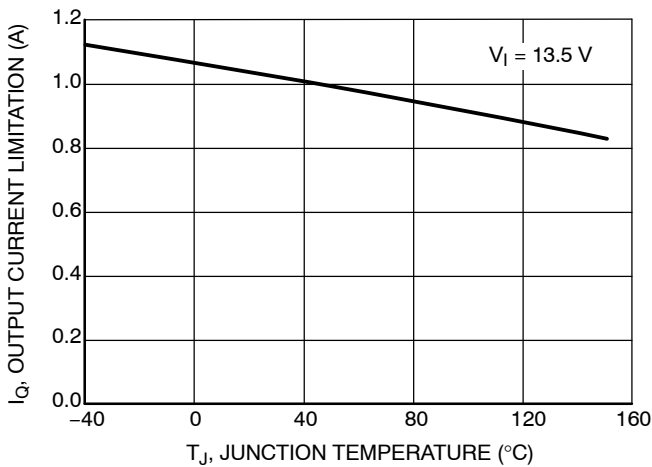

Figure 6. Output Current  $I_Q$  vs. Temperature  $T_J$

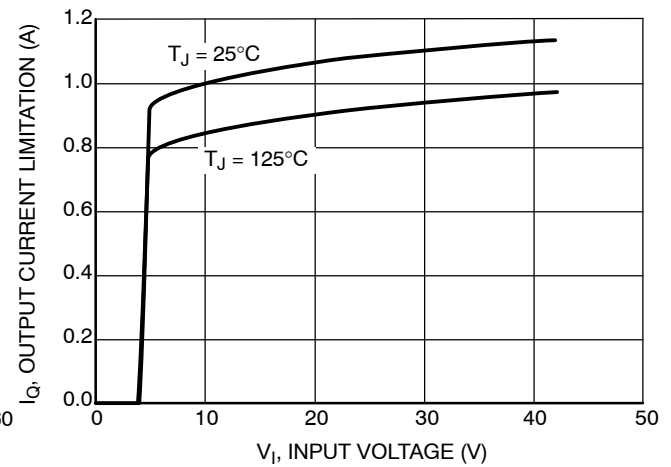

Figure 7. Output Current  $I_Q$  vs. Input Voltage  $V_I$

TYPICAL PERFORMANCE CHARACTERISTICS

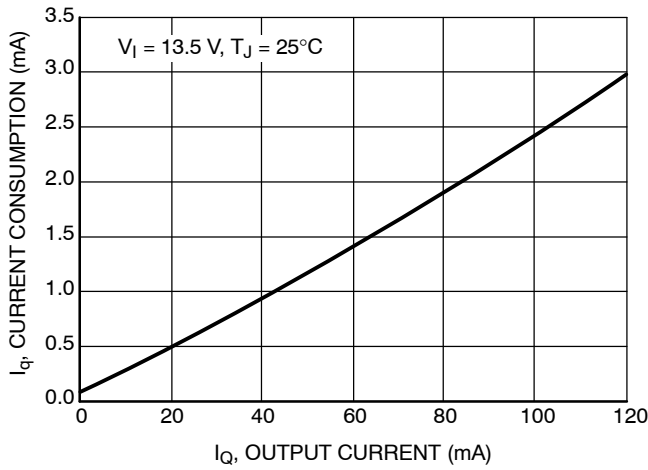

Figure 8. Current Consumption  $I_q$  vs. Output Current  $I_Q$

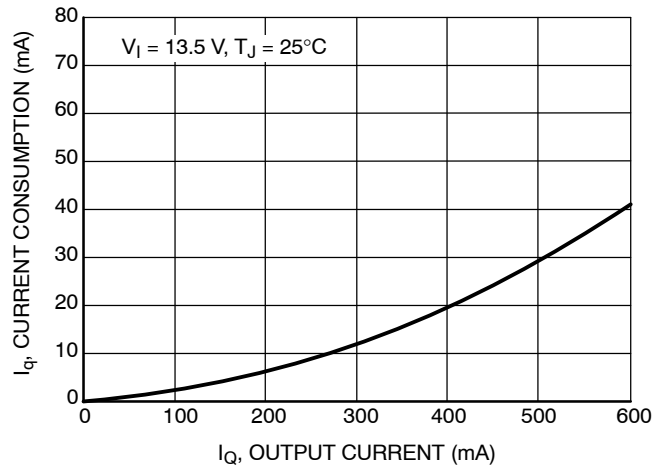

Figure 9. Current Consumption  $I_q$  vs. Output Current  $I_Q$

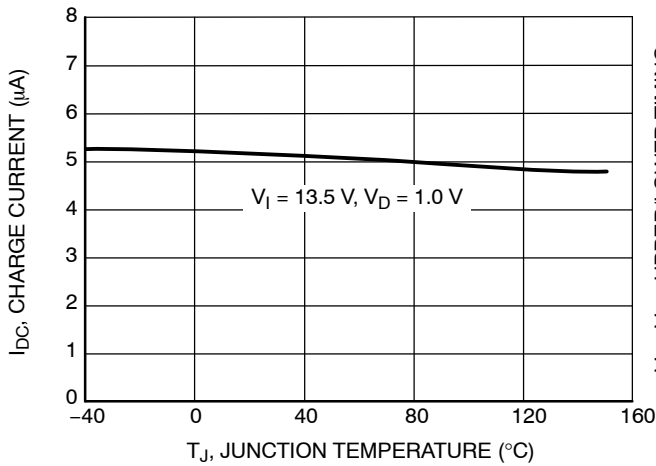

Figure 10. Charge Current  $I_{D,C}$  vs. Temperature  $T_J$

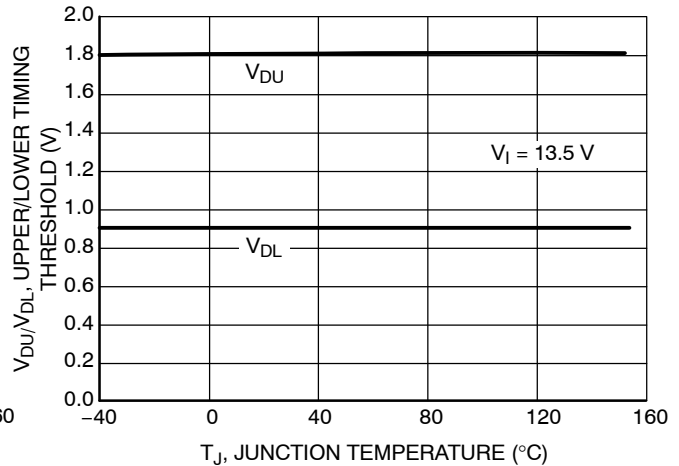

Figure 11. Delay Switching Threshold  $V_{DU}$ ,  $V_{DL}$  vs. Temperature  $T_J$

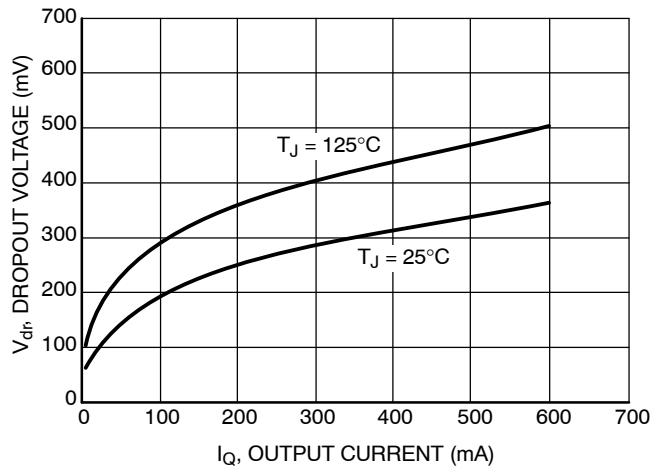

Figure 12. Drop Voltage  $V_{dr}$  vs. Output Current  $I_Q$

APPLICATION INFORMATION

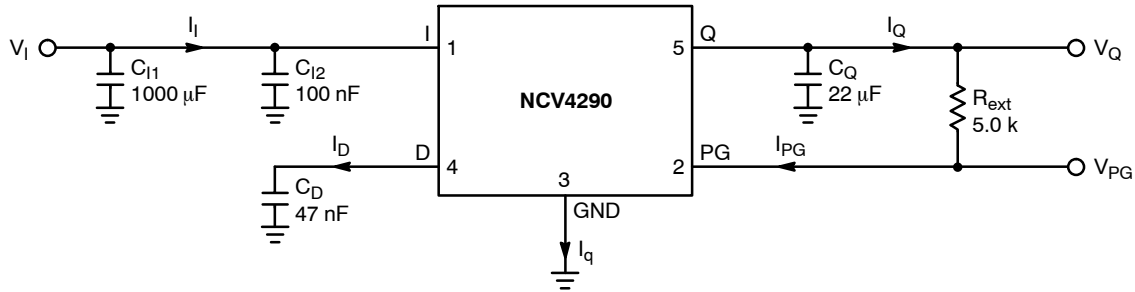

Figure 13. Test Circuit

**Circuit Description**

The NCV4290 is an integrated low dropout regulator that provides 5.0 V, 450 mA protected output and a signal for power on power good. The regulation is provided by a PNP pass transistor controlled by an error amplifier with a bandgap reference, which gives it the lowest possible drop out voltage and best possible temperature stability. The output current capability is 450 mA, and the base drive quiescent current is controlled to prevent over saturation when the input voltage is low or when the output is overloaded. The regulator is protected by both current limit and thermal shutdown. Thermal shutdown occurs above 150°C to protect the IC during overloads and extreme ambient temperatures. The delay time for the power good output is adjustable by selection of the timing capacitor. See Figure 13, Test Circuit, for circuit element nomenclature illustration.

**Regulator**

The error amplifier compares the reference voltage to a sample of the output voltage (V<sub>Q</sub>) and drives the base of a PNP series pass transistor by a buffer. The reference is a bandgap design to give it a temperature-stable output. Saturation control of the PNP is a function of the load current and input voltage. Over saturation of the output power device is prevented, and quiescent current in the ground pin is minimized.

**Regulator Stability Considerations**

The input capacitors (C<sub>I1</sub> and C<sub>I2</sub>) are necessary to stabilize the input impedance to avoid voltage line influences. Using a resistor of approximately 1.0 Ω in series with C<sub>I2</sub> can stop potential oscillations caused by stray inductance and capacitance.

The output capacitor helps determine three main characteristics of a linear regulator: startup delay, load transient response and loop stability. The capacitor value and type should be based on cost, availability, size and temperature constraints. A tantalum, aluminum or ceramic capacitors can be used. The range of stability versus capacitance, load current and capacitive ESR is illustrated in Figures 2 and 3. Minimum ESR for C<sub>Q</sub> = 22 μF is native ESR of ceramic capacitors. The aluminum electrolytic

capacitor is the least expensive solution, but, if the circuit operates at low temperatures (–25°C to –40°C), both the capacitance and ESR of the capacitor will vary considerably. The capacitor manufacturer’s data sheet usually provides this information.

The value for the output capacitor C<sub>Q</sub> shown in Figure 13, Test Circuit, should work for most applications; however, it is not necessarily the optimized solution. Stability is guaranteed for C<sub>Q</sub> ≥ 22 μF and an ESR ≤ 4.0 Ω.

ESR characteristics were measured with ceramic capacitors and additional resistors to emulate ESR. Murata ceramic capacitors were used, GRM32ER71C226ME18 (22 μF, 16 V, X7R, 1210), GRM219R71E105KA88 (1 μF, 25 V, X7R, 0805).

**Power Good Output**

The power good output is used as the power on indicator to the microcontroller. This signal indicates when the output voltage is suitable for reliable operation of the controller. It pulls low when the output is not considered to be ready. PG is pulled up to V<sub>Q</sub> by an external resistor, typically 5.0 kΩ in value. Hysteresis is implemented for PG signal. When output voltage is decreasing PG goes Low at V<sub>Q</sub> typ 3.65 V and when output voltage is increasing PG goes High at V<sub>Q</sub> typ 4.65 V. The input and output conditions that control the Power Good Output and the relative timing are illustrated in Figure 14, Power Good Timing.

Output voltage regulation must be maintained for the delay time before the power good output signals a valid condition. The delay for the power good output is defined as the amount of time it takes the timing capacitor on the delay pin to charge from a residual voltage of 0.0 V to the upper timing threshold voltage V<sub>DU</sub>. The charging current for this is I<sub>D,C</sub> and D pin voltage in steady state is typically 2.85 V. By using typical IC parameters with a 47 nF capacitor on the D pin, the following time delay for 5.0 V regulator is derived:

$$t_{RD} = C_D V_{DU} / I_{D,C}$$

$$t_{RD} = 47 \text{ nF} (1.8 \text{ V}) / 6.0 \text{ μA} = 14.1 \text{ ms}$$

Other time delays can be obtained by changing the capacitor value.

# NCV4290

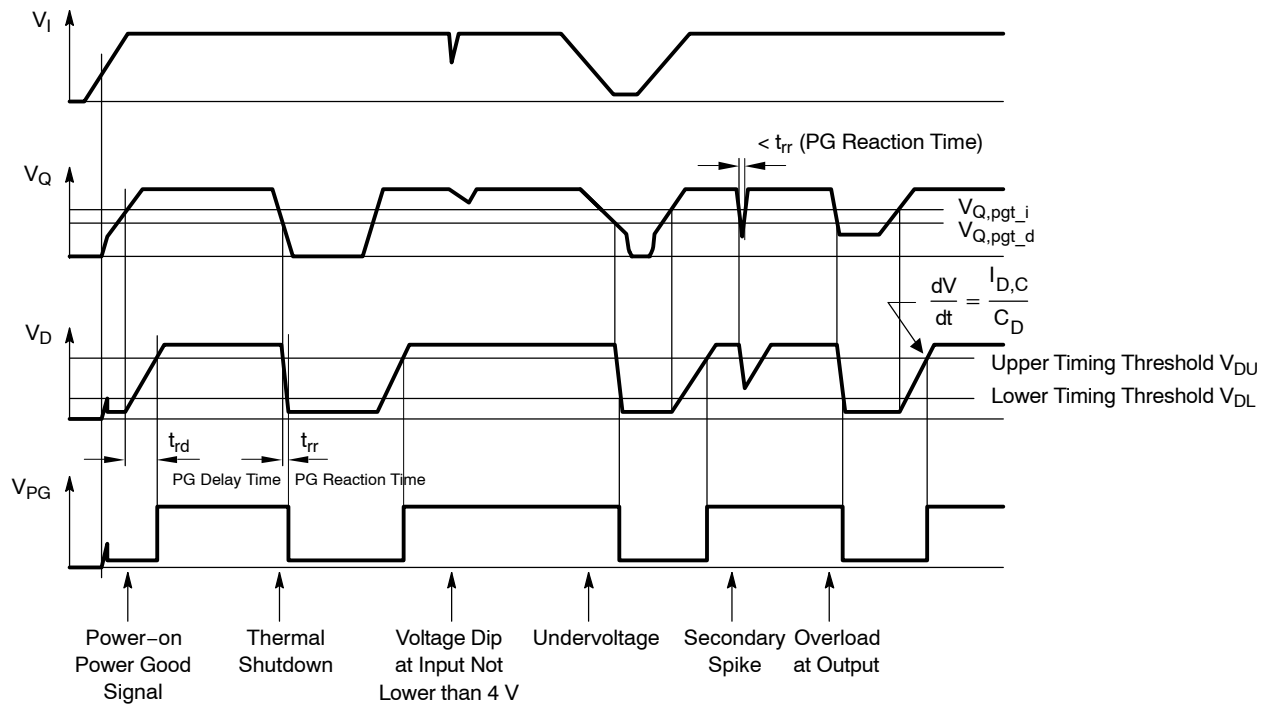

**Figure 14. Power Good Timing**



**Calculating Power Dissipation in a Single Output Linear Regulator**

The maximum power dissipation for a single output regulator (Figure 15) is:

$$P_{D(max)} = [V_{I(max)} - V_{Q(min)}]I_{Q(max)} + V_{I(max)}I_q \tag{1}$$

where

- $V_{I(max)}$  is the maximum input voltage,
- $V_{Q(min)}$  is the minimum output voltage,
- $I_{Q(max)}$  is the maximum output current for the application,
- $I_q$  is the quiescent current the regulator consumes at  $I_{Q(max)}$ .

Once the value of  $P_{D(max)}$  is known, the maximum permissible value of  $R_{\theta JA}$  can be calculated:

$$R_{\theta JA} = \frac{150^{\circ}C - T_A}{P_D} \tag{2}$$

The value of  $R_{\theta JA}$  can then be compared with those in the package section of the data sheet. Those packages with  $R_{\theta JA}$ 's less than the calculated value in Equation 2 will keep the die temperature below 150°C.

In some cases, none of the packages will be sufficient to dissipate the heat generated by the IC, and an external heatsink will be required.

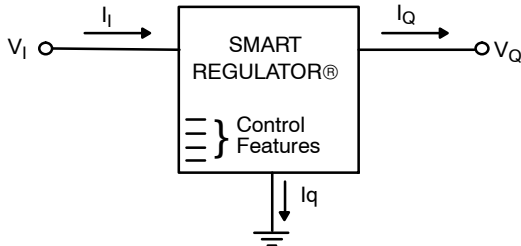

**Figure 15. Single Output Regulator with Key Performance Parameters Labeled**

**Heatsinks**

A heatsink effectively increases the surface area of the package to improve the flow of heat away from the IC and into the surrounding air.

Each material in the heat flow path between the IC and the outside environment will have a thermal resistance. Like series electrical resistances, these resistances are summed to determine the value of  $R_{\theta JA}$ :

$$R_{\theta JA} = R_{\theta JC} + R_{\theta CS} + R_{\theta SA} \tag{3}$$

where

- $R_{\theta JC}$  is the junction-to-case thermal resistance,
- $R_{\theta CS}$  is the case-to-heatsink thermal resistance,
- $R_{\theta SA}$  is the heatsink-to-ambient thermal resistance.

$R_{\theta JA}$  appears in the package section of the data sheet. Like  $R_{\theta JA}$ , it too is a function of package type.  $R_{\theta CS}$  and  $R_{\theta SA}$  are functions of the package type, heatsink and the interface between them. These values appear in heatsink data sheets of heatsink manufacturers.

Thermal, mounting, and heatsinking considerations are discussed in the ON Semiconductor application note AN1040/D.

**Thermal Model**

A discussion of thermal modeling is in the ON Semiconductor web site: <http://www.onsemi.com/pub/collateral/BR1487-D.PDF>.

**Table 1. DPAK 5-Lead Thermal RC Network Models**

Drain Copper Area (1 oz thick)			168 mm <sup>2</sup>	736 mm <sup>2</sup>		168 mm <sup>2</sup>	736 mm <sup>2</sup>	
(SPICE Deck Format)			Cauer Network			Foster Network		
			168 mm <sup>2</sup>	736 mm <sup>2</sup>	Units	Tau	Tau	Units
<b>C_C1</b>	<b>Junction</b>	<b>Gnd</b>	9.5059E-06	9.5059E-06	W-s/C	1.000E-06	1.000E-06	sec
<b>C_C2</b>	<b>node1</b>	<b>Gnd</b>	3.7125E-05	3.7125E-05	W-s/C	1.000E-05	1.000E-05	sec
<b>C_C3</b>	<b>node2</b>	<b>Gnd</b>	1.1233E-05	1.1233E-05	W-s/C	1.000E-04	1.000E-04	sec
<b>C_C4</b>	<b>node3</b>	<b>Gnd</b>	6.5344E-04	6.5339E-04	W-s/C	4.893E-04	4.893E-04	sec
<b>C_C5</b>	<b>node4</b>	<b>Gnd</b>	2.1647E-02	2.1606E-02	W-s/C	4.770E-03	4.770E-03	sec
C_C6	node5	Gnd	2.1471E-02	2.1361E-02	W-s/C	4.129E-02	4.129E-02	sec
C_C7	node6	Gnd	7.9135E-02	7.8444E-02	W-s/C	4.237E-01	4.237E-01	sec
C_C8	node7	Gnd	2.8534E-01	3.1338E-01	W-s/C	3.499	3.499	sec
C_C9	node8	Gnd	6.6085E-01	1.5496	W-s/C	8.532	49.601	sec
C_C10	node9	Gnd	8.7266E-01	24.4877	W-s/C	77.552	88.429	sec
			168 mm <sup>2</sup>	736 mm <sup>2</sup>		R's	R's	
<b>R_R1</b>	<b>Junction</b>	<b>node1</b>	1.3480E-01	1.3480E-01	C/W	0.0803	0.0803	C/W
<b>R_R2</b>	<b>node1</b>	<b>node2</b>	3.0852E-01	3.0853E-01	C/W	0.1736	0.1736	C/W
<b>R_R3</b>	<b>node2</b>	<b>node3</b>	8.0674E-01	8.0676E-01	C/W	0.5491	0.5491	C/W
<b>R_R4</b>	<b>node3</b>	<b>node4</b>	5.8520E-01	5.8528E-01	C/W	0.9733	0.9733	C/W
<b>R_R5</b>	<b>node4</b>	<b>node5</b>	4.7850E-01	4.8022E-01	C/W	0.1096	0.1096	C/W
R_R6	node5	node6	1.3832	1.3916	C/W	0.7361	0.7361	C/W
R_R7	node6	node7	4.8520	4.8196	C/W	2.8713	2.8713	C/W
R_R8	node7	node8	18.0698	10.0128	C/W	3.0988	8.1070	C/W
R_R9	node8	node9	15.7788	31.8880	C/W	10.1005	14.0987	C/W
R_R10	node9	Gnd	33.5404	2.7829	C/W	57.2455	25.5115	C/W

NOTE: Bold face items represent the package without the external thermal system.

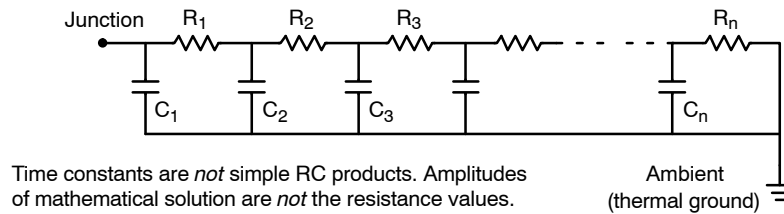

**Figure 16. Grounded Capacitor Thermal Network (“Cauer” Ladder)**

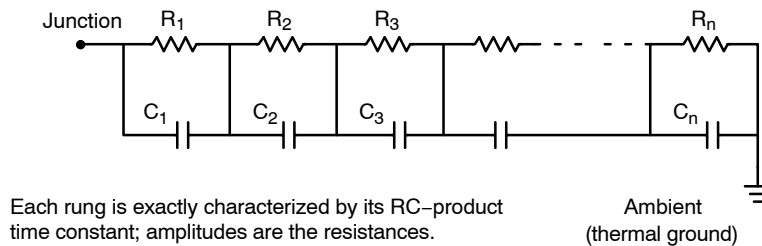

**Figure 17. Non-Grounded Capacitor Thermal Ladder (“Foster” Ladder)**

# NCV4290

**Table 2. D<sup>2</sup>PAK 5-Lead Thermal RC Network Models**

Drain Copper Area (1 oz thick)			241 mm <sup>2</sup>	788 mm <sup>2</sup>		241 mm <sup>2</sup>	788 mm <sup>2</sup>	
(SPICE Deck Format)			Cauer Network			Foster Network		
			241 mm <sup>2</sup>	788 mm <sup>2</sup>	Units	Tau	Tau	Units
<b>C_C1</b>	<b>Junction</b>	<b>Gnd</b>	9.5070E-06	9.5071E-06	W-s/C	1.000E-06	1.000E-06	sec
<b>C_C2</b>	<b>node1</b>	<b>Gnd</b>	3.7150E-05	3.7151E-05	W-s/C	1.000E-05	1.000E-05	sec
<b>C_C3</b>	<b>node2</b>	<b>Gnd</b>	1.1261E-04	1.1262E-04	W-s/C	1.000E-04	1.000E-04	sec
<b>C_C4</b>	<b>node3</b>	<b>Gnd</b>	6.6126E-04	6.6143E-04	W-s/C	4.893E-04	4.893E-04	sec
<b>C_C5</b>	<b>node4</b>	<b>Gnd</b>	2.9986E-02	3.0234E-02	W-s/C	4.770E-03	4.770E-03	sec
C_C6	node5	Gnd	5.2806E-02	5.4409E-02	W-s/C	4.129E-02	4.129E-02	sec
C_C7	node6	Gnd	3.9578E-01	4.6168E-01	W-s/C	1.294E+00	1.294E+00	sec
C_C8	node7	Gnd	9.6950E-01	1.66	W-s/C	2.089E+01	6.008E+01	sec
C_C9	node8	Gnd	2.26	37.44	W-s/C	5.824E+01	7.069E+01	sec
C_C10	node9	Gnd	231.58	4089.09	W-s/C			sec
			241 mm <sup>2</sup>	788 mm <sup>2</sup>		R's	R's	
<b>R_R1</b>	<b>Junction</b>	<b>node1</b>	1.3476E-01	1.3476E-01	C/W	0.0803	0.0803	C/W
<b>R_R2</b>	<b>node1</b>	<b>node2</b>	3.0817E-01	3.0817E-01	C/W	0.1736	0.1736	C/W
<b>R_R3</b>	<b>node2</b>	<b>node3</b>	8.0361E-01	8.0355E-01	C/W	0.5491	0.5491	C/W
<b>R_R4</b>	<b>node3</b>	<b>node4</b>	5.7370E-01	5.7346E-01	C/W	0.9733	0.9733	C/W
<b>R_R5</b>	<b>node4</b>	<b>node5</b>	2.6250E-01	2.5833E-01	C/W	0.1096	0.1096	C/W
R_R6	node5	node6	5.6022E-01	5.3623E-01	C/W	0.5367	0.5367	C/W
R_R7	node6	node7	4.0655	3.1454	C/W	1.8971	1.8971	C/W
R_R8	node7	node8	38.4592	42.3515	C/W	2.9679	2.9679	C/W
R_R9	node8	node9	14.9707	1.9244	C/W	1.9498	4.0572	C/W
R_R10	node9	gnd	2.5618E-01	1.6530E-02	C/W			C/W

NOTE: Bold face items represent the package without the external thermal system.

The Cauer networks generally have physical significance and may be divided between nodes to separate thermal behavior due to one portion of the network from another. The Foster networks, though when sorted by time constant (as above) bear a rough correlation with the Cauer networks, are really only convenient mathematical models. Cauer networks can be easily implemented using circuit simulating tools, whereas Foster networks may be more easily implemented using mathematical tools (for instance, in a spreadsheet program), according to the following formula:

$$R(t) = \sum_{i=1}^n R_i (1 - e^{-t/\tau_{ai}})$$

# NCV4290

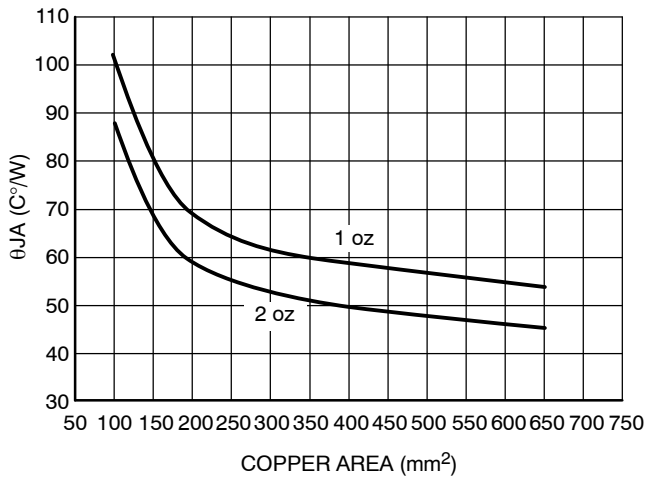

Figure 18.  $\theta_{JA}$  vs. Copper Spreader Area, DPAK 5-Lead

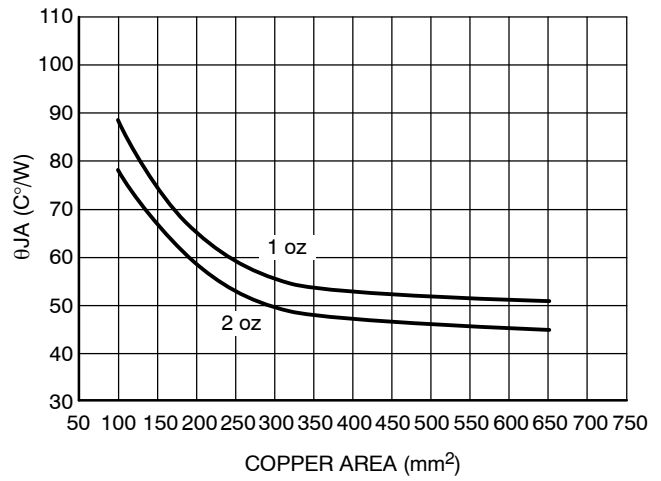

Figure 19.  $\theta_{JA}$  vs. Copper Spreader Area,  $\text{D}^2\text{PAK}$  5-Lead

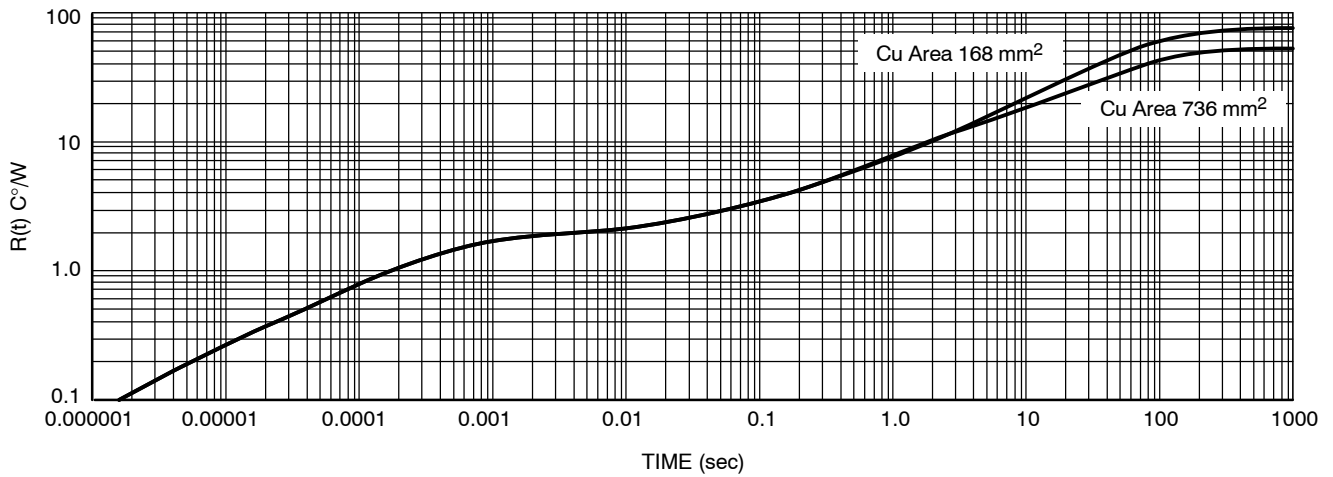

Figure 20. Single-Pulse Heating Curves, DPAK 5-Lead

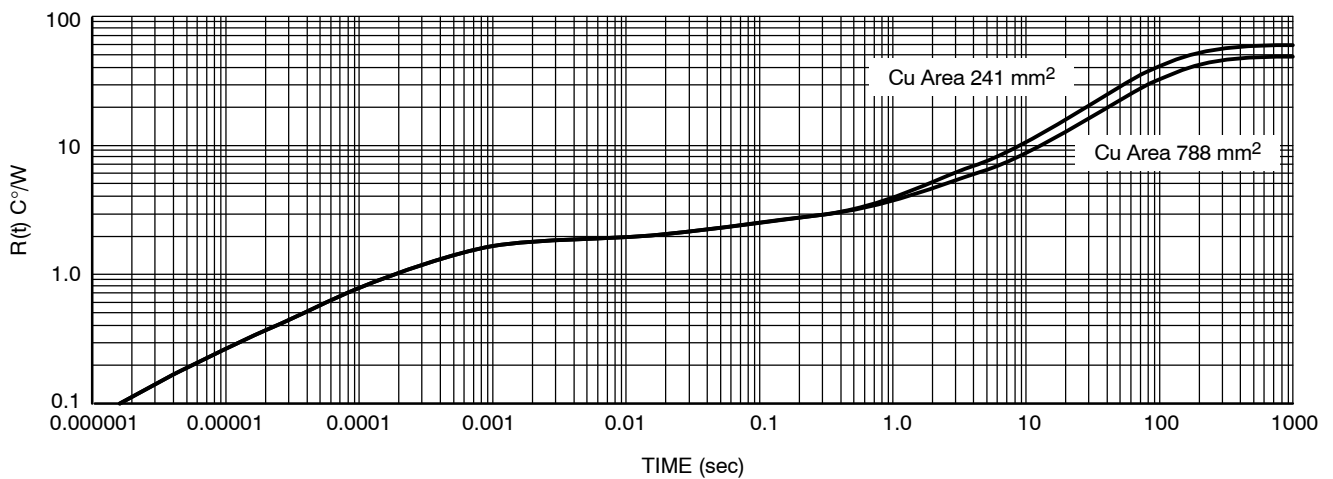

Figure 21. Single-Pulse Heating Curves,  $\text{D}^2\text{PAK}$  5-Lead

# NCV4290

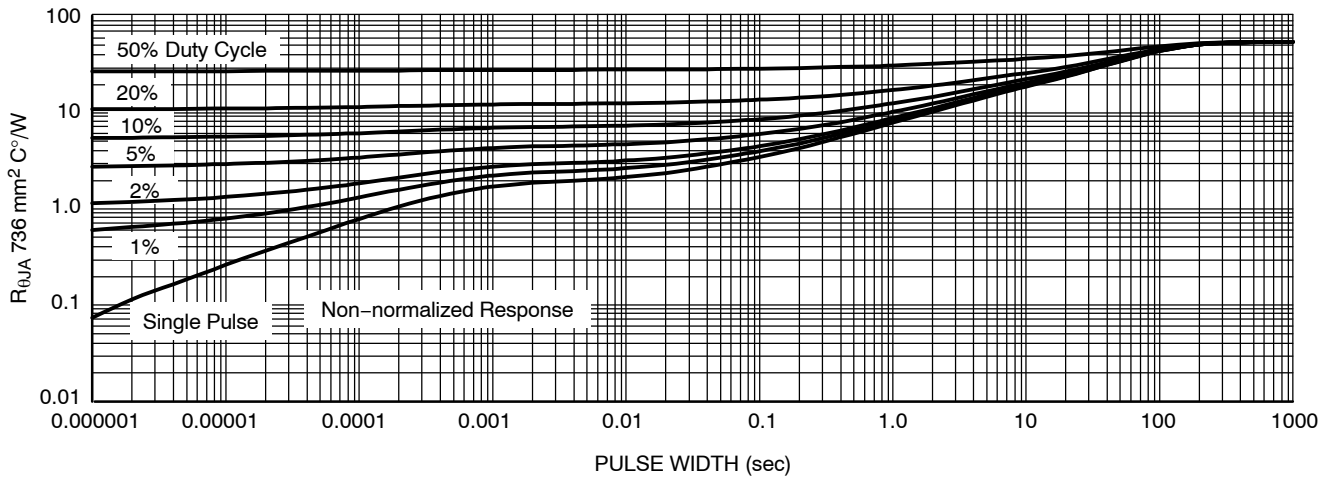

Figure 22. Duty Cycle for 1" Spreader Boards, DPAK 5-Lead

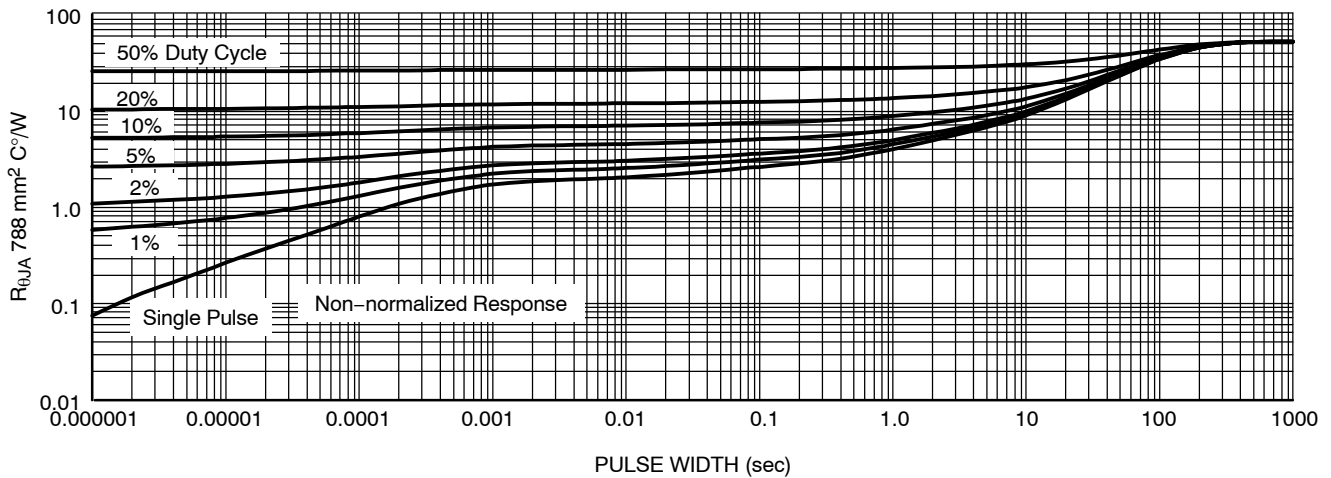

Figure 23. Duty Cycle for 1" Spreader Boards, D<sup>2</sup>PAK 5-Lead

## ORDERING INFORMATION

Device	Output Voltage	Package	Shipping <sup>†</sup>
NCV4290DS50R4G	5.0 V	D <sup>2</sup> PAK (Pb-Free)	800 / Tape & Reel
NCV4290DT50RKG		DPAK (Pb-Free)	2500 / Tape & Reel

<sup>†</sup>For information on tape and reel specifications, including part orientation and tape sizes, please refer to our Tape and Reel Packaging Specifications Brochure, BRD8011/D.

# NCV4290

## PACKAGE DIMENSIONS

DPAK 5, CENTER LEAD CROP  
DT SUFFIX  
CASE 175AA  
ISSUE A

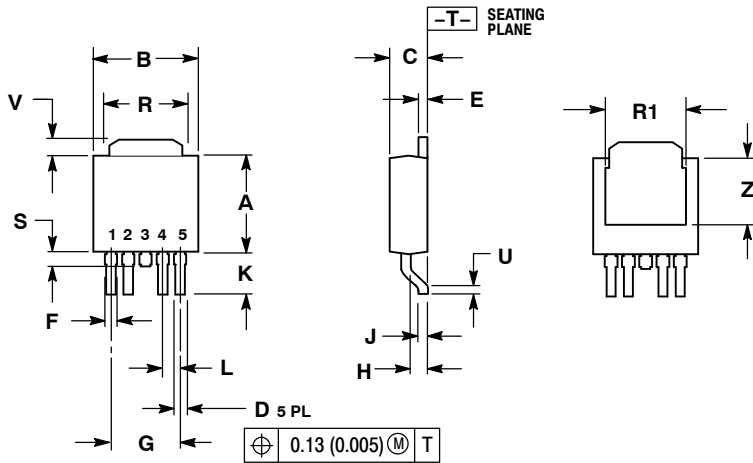

- NOTES:  
1. DIMENSIONING AND TOLERANCING PER ANSI Y14.5M, 1982.  
2. CONTROLLING DIMENSION: INCH.

DIM	INCHES		MILLIMETERS	
	MIN	MAX	MIN	MAX
A	0.235	0.245	5.97	6.22
B	0.250	0.265	6.35	6.73
C	0.086	0.094	2.19	2.38
D	0.020	0.028	0.51	0.71
E	0.018	0.023	0.46	0.58
F	0.024	0.032	0.61	0.81
G	0.180 BSC		4.56 BSC	
H	0.034	0.040	0.87	1.01
J	0.018	0.023	0.46	0.58
K	0.102	0.114	2.60	2.89
L	0.045 BSC		1.14 BSC	
R	0.170	0.190	4.32	4.83
R1	0.185	0.210	4.70	5.33
S	0.025	0.040	0.63	1.01
U	0.020	---	0.51	---
V	0.035	0.050	0.89	1.27
Z	0.155	0.170	3.93	4.32

### SOLDERING FOOTPRINT\*

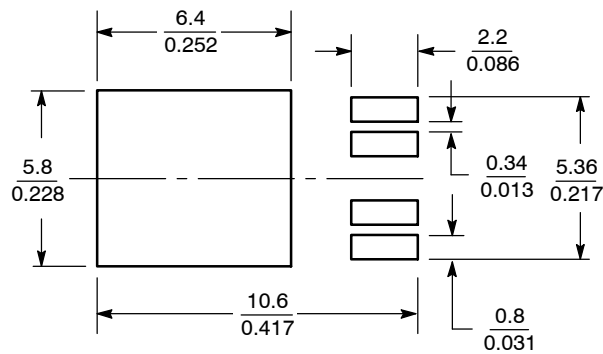

SCALE 4:1  $\left(\frac{\text{mm}}{\text{inches}}\right)$

\*For additional information on our Pb-Free strategy and soldering details, please download the ON Semiconductor Soldering and Mounting Techniques Reference Manual, SOLDERRM/D.

# NCV4290

## PACKAGE DIMENSIONS

**D<sup>2</sup>PAK, 5 LEAD  
DS SUFFIX  
CASE 936A-02  
ISSUE C**

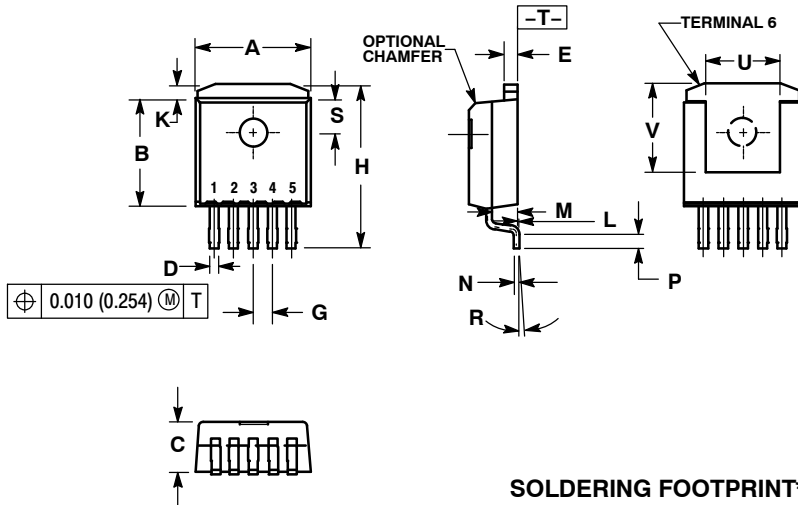

**NOTES:**

1. DIMENSIONING AND TOLERANCING PER ANSI Y14.5M, 1982.
2. CONTROLLING DIMENSION: INCH.
3. TAB CONTOUR OPTIONAL WITHIN DIMENSIONS A AND K.
4. DIMENSIONS U AND V ESTABLISH A MINIMUM MOUNTING SURFACE FOR TERMINAL 6.
5. DIMENSIONS A AND B DO NOT INCLUDE MOLD FLASH OR GATE PROTRUSIONS. MOLD FLASH AND GATE PROTRUSIONS NOT TO EXCEED 0.025 (0.635) MAXIMUM.

DIM	INCHES		MILLIMETERS	
	MIN	MAX	MIN	MAX
A	0.386	0.403	9.804	10.236
B	0.356	0.368	9.042	9.347
C	0.170	0.180	4.318	4.572
D	0.026	0.036	0.660	0.914
E	0.045	0.055	1.143	1.397
G	0.067 BSC		1.702 BSC	
H	0.539	0.579	13.691	14.707
K	0.050 REF		1.270 REF	
L	0.000	0.010	0.000	0.254
M	0.088	0.102	2.235	2.591
N	0.018	0.026	0.457	0.660
P	0.058	0.078	1.473	1.981
R	5° REF		5° REF	
S	0.116 REF		2.946 REF	
U	0.200 MIN		5.080 MIN	
V	0.250 MIN		6.350 MIN	

**SOLDERING FOOTPRINT\***

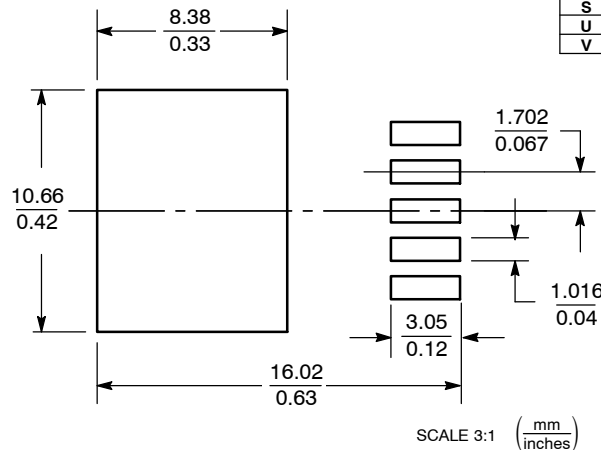

\*For additional information on our Pb-Free strategy and soldering details, please download the ON Semiconductor Soldering and Mounting Techniques Reference Manual, SOLDERRM/D.

ON Semiconductor and are registered trademarks of Semiconductor Components Industries, LLC (SCILLC). SCILLC owns the rights to a number of patents, trademarks, copyrights, trade secrets, and other intellectual property. A listing of SCILLC's product/patent coverage may be accessed at [www.onsemi.com/site/pdf/Patent-Marking.pdf](http://www.onsemi.com/site/pdf/Patent-Marking.pdf). SCILLC reserves the right to make changes without further notice to any products herein. SCILLC makes no warranty, representation or guarantee regarding the suitability of its products for any particular purpose, nor does SCILLC assume any liability arising out of the application or use of any product or circuit, and specifically disclaims any and all liability, including without limitation special, consequential or incidental damages. "Typical" parameters which may be provided in SCILLC data sheets and/or specifications can and do vary in different applications and actual performance may vary over time. All operating parameters, including "Typicals" must be validated for each customer application by customer's technical experts. SCILLC does not convey any license under its patent rights nor the rights of others. SCILLC products are not designed, intended, or authorized for use as components in systems intended for surgical implant into the body, or other applications intended to support or sustain life, or for any other application in which the failure of the SCILLC product could create a situation where personal injury or death may occur. Should Buyer purchase or use SCILLC products for any such unintended or unauthorized application, Buyer shall indemnify and hold SCILLC and its officers, employees, subsidiaries, affiliates, and distributors harmless against all claims, costs, damages, and expenses, and reasonable attorney fees arising out of, directly or indirectly, any claim of personal injury or death associated with such unintended or unauthorized use, even if such claim alleges that SCILLC was negligent regarding the design or manufacture of the part. SCILLC is an Equal Opportunity/Affirmative Action Employer. This literature is subject to all applicable copyright laws and is not for resale in any manner.

**PUBLICATION ORDERING INFORMATION**

**LITERATURE FULFILLMENT:**  
Literature Distribution Center for ON Semiconductor  
P.O. Box 5163, Denver, Colorado 80217 USA  
**Phone:** 303-675-2175 or 800-344-3860 Toll Free USA/Canada  
**Fax:** 303-675-2176 or 800-344-3867 Toll Free USA/Canada  
**Email:** [orderlit@onsemi.com](mailto:orderlit@onsemi.com)

**N. American Technical Support:** 800-282-9855 Toll Free  
USA/Canada  
**Europe, Middle East and Africa Technical Support:**  
Phone: 421 33 790 2910  
**Japan Customer Focus Center**  
Phone: 81-3-5817-1050

**ON Semiconductor Website:** [www.onsemi.com](http://www.onsemi.com)  
**Order Literature:** <http://www.onsemi.com/orderlit>

For additional information, please contact your local Sales Representative