

Automotive Grade Start-Stop Non-Synchronous Boost Controller

NCV8876

The NCV8876 is a Non-Synchronous Boost controller designed to supply a minimum output voltage during Start-Stop vehicle operation battery voltage sags. The controller drives an external N-channel MOSFET. The device uses peak current mode control with internal slope compensation. The IC incorporates an internal regulator that supplies charge to the gate driver.

Protection features include, cycle-by-cycle current limiting, protection and thermal shutdown.

Additional features include low quiescent current sleep mode operation. The NCV8876 is enabled when the supply voltage drops below 7.3 V, with boost operation initiated when the supply voltage is below 6.8 V.

Features

- Automatic Enable Below 7.3 V (Factory Programmable)
- Boost Mode Operation at 6.8 V
- $\pm 2\%$ Output Accuracy Over Temperature Range
- Peak Current Mode Control with Internal Slope Compensation
- Externally Adjustable Frequency Operation
- Wide Input Voltage Range of 2 V to 40 V, 45 V Load Dump
- Low Quiescent Current in Sleep Mode ($<11 \mu\text{A}$ Typical)
- Cycle-by-Cycle Current Limit Protection
- Hiccup-Mode Overcurrent Protection (OCP)
- Thermal Shutdown (TSD)
- This is a Pb-Free Device
- NCV Prefix for Automotive and Other Applications Requiring Unique Site and Control Change Requirements; AEC-Q100 Qualified and PPAP Capable

Typical Applications

- Applications Requiring Regulated Voltage through Cranking and Start-Stop Operation



SOIC-8
 D SUFFIX
 CASE 751

MARKING DIAGRAM

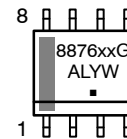

8876xxG= Specific Device Code
 xx = 01
 A = Assembly Location
 L = Wafer Lot
 Y = Year
 W = Work Week
 ■ = Pb-Free Package

PIN CONNECTIONS

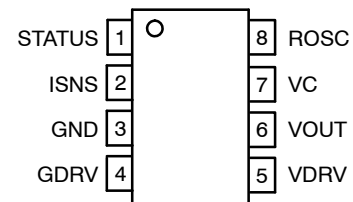

(Top View)

ORDERING INFORMATION

Device	Package	Shipping†
NCV887601D1R2G	SOIC-8 (Pb-Free)	2500 / Tape & Reel

†For information on tape and reel specifications, including part orientation and tape sizes, please refer to our Tape and Reel Packaging Specification Brochure, [BRD8011/D](#).

NCV8876

ABSOLUTE MAXIMUM RATINGS (Voltages are with respect to GND, unless otherwise indicated)

Rating	Value	Unit
Dc Supply Voltage (VOUT)	-0.3 to 40	V
Peak Transient Voltage (Load Dump on VOUT)	45	V
Dc Supply Voltage (VDRV, GDRV)	12	V
Dc Voltage (VC, ISNS, ROSC)	-0.3 to 3.6	V
Dc Voltage (STATUS)	-0.3 to 6	V
Dc Voltage Stress (VOUT - VDRV)	-0.7 to 40	V
Operating Junction Temperature	-40 to 150	°C
Storage Temperature Range	-65 to 150	°C
Peak Reflow Soldering Temperature: Pb-Free, 60 to 150 seconds at 217°C	265 peak	°C

Stresses exceeding those listed in the Maximum Ratings table may damage the device. If any of these limits are exceeded, device functionality should not be assumed, damage may occur and reliability may be affected.

PACKAGE CAPABILITIES

Characteristic	Value	Unit
ESD Capability (All Pins)	Human Body Model	≥2.0
	Machine Model	≥200
Moisture Sensitivity Level	1	
Package Thermal Resistance	Junction-to-Ambient, R _{θJA} (Note 1)	100 °C/W

1. 1 in², 1 oz copper area used for heatsinking.

TYPICAL VALUES

Part No.	D _{max}	f _s	S _a	V _{cl}	I _{src}	I _{sink}	VOUT	SCE
NCV887601	83%	170 kHz	53 mV/μs	200 mV	800 mA	600 mA	6.8 V	N

NCV8876

ELECTRICAL CHARACTERISTICS ($-40^{\circ}\text{C} < T_J < 150^{\circ}\text{C}$, $3.6\text{ V} < V_{\text{OUT}} < 40\text{ V}$, unless otherwise specified) Min/Max values are guaranteed by test, design or statistical correlation.

Characteristic	Symbol	Conditions	Min	Typ	Max	Unit
----------------	--------	------------	-----	-----	-----	------

GENERAL

Quiescent Current, Sleep Mode	$I_{q,\text{sleep}}$	$V_{\text{OUT}} = 13.2\text{ V}$, $T_J = 25^{\circ}\text{C}$	–	12	14	μA
Quiescent Current, No switching	$I_{q,\text{off}}$	Into V_{OUT} pin, $6.8\text{ V} < V_{\text{OUT}} < 7.3\text{ V}$, No switching	–	2.2	4.0	mA

OSCILLATOR

Switching Frequency	F_{SW}	Operating Range NCV887601	153		501	kHz
R_{OSC} Voltage	V_{ROSC}		–	1.0	–	V
Default Switching	F_{SW}	ROSC = Open ROSC = 100 $\text{k}\Omega$ ROSC = 20 $\text{k}\Omega$ ROSC = 10 $\text{k}\Omega$	153 180 283 409	170 200 315 455	187 220 347 501	kHz
Minimum Pulse Width	$t_{\text{on,min}}$		90	115	140	ns
Maximum Duty Cycle	D_{max}	ROSC = OPEN	81	83	85	$\%$
Slope Compensating Ramp (Note 2)	S_a	NCV887601	46	53	60	$\text{mV}/\mu\text{s}$

STATUS FLAG

STATUS Wake Up Delay		$V_{\text{OUT}} < 7.3\text{ V}$	–	9.3	14.0	μs
STATUS Pull-down Capability		Sinking 1.0 mA	–	–	400	mV

CURRENT SENSE AMPLIFIER

Low-Frequency Gain	A_{csa}	Input-to-output gain at dc, $I_{\text{SNS}} \leq 1\text{ V}$	0.9	1.0	1.1	V/V
Bandwidth	BW_{csa}	Gain of $A_{\text{csa}} - 3\text{ dB}$	2.5	–	–	MHz
ISNS Input Bias Current	$I_{\text{sns,bias}}$	Out of ISNS pin	–	30	50	μA
Current Limit Threshold Voltage	V_{cl}	Voltage on ISNS pin NCV887601	180	200	220	mV
Current Limit, Response Time (Note 2)	t_{cl}	CL tripped until GDRV falling edge, $V_{\text{ISNS}} = V_{\text{cl}}(\text{typ}) + 60\text{ mV}$	–	80	125	ns
Overcurrent Protection, Threshold Voltage	$\%V_{\text{ocp}}$	Percent of V_{cl}	125	150	175	$\%$
Overcurrent Protection, Response Time (Note 2)	t_{ocp}	From overcurrent event, Until switching stops, $V_{\text{ISNS}} = V_{\text{OCP}} + 40\text{ mV}$	–	80	125	ns

VOLTAGE ERROR OPERATIONAL TRANSCONDUCTANCE AMPLIFIER

Transconductance	$g_{m,\text{vea}}$	$V_{\text{OUT}} = \pm 100\text{ mV}$	0.8	1.2	1.63	mS
VEA Output Resistance (Note 2)	$R_{o,\text{vea}}$		2.0	–	–	$\text{M}\Omega$
VEA Maximum Output Voltage	$V_{c,\text{max}}$		2.5	–	–	V
VEA Sourcing Current	$I_{\text{src,vea}}$	VEA output current, $V_c = 2.0\text{ V}$	80	100	–	μA
VEA Sinking Current	$I_{\text{snk,vea}}$	VEA output current, $V_c = 1.5\text{ V}$	80	100	–	μA
VEA Clamp Voltage	$V_{c,\text{clamp}}$	$V_{\text{OUT}} < 7.3\text{ V}$	–	1.1	–	V
VC Delay		$V_{\text{OUT}} < 7.3\text{ V}$ with V_c pin compensation network disconnected	–	53	60	μs

GATE DRIVER (Note 3)

Sourcing Current	I_{src}	$V_{\text{DRV}} \geq 6\text{ V}$, $V_{\text{DRV}} - V_{\text{GDRV}} = 2\text{ V}$ NCV887601	550	800	–	mA
Sinking Current	I_{sink}	$V_{\text{GDRV}} \geq 2\text{ V}$ NCV887601	500	600	–	mA
Driving Voltage Dropout (Note 2)	$V_{\text{drv,do}}$	$V_{\text{OUT}} - V_{\text{DRV}}$, $I_{\text{DRV}} = 25\text{ mA}$	–	0.3	0.6	V
Driving Voltage Source Current	I_{drv}	$V_{\text{OUT}} - V_{\text{DRV}} = 1\text{ V}$	35	45	–	mA

NCV8876

ELECTRICAL CHARACTERISTICS ($-40^{\circ}\text{C} < T_J < 150^{\circ}\text{C}$, $3.6\text{ V} < V_{\text{OUT}} < 40\text{ V}$, unless otherwise specified) Min/Max values are guaranteed by test, design or statistical correlation.

Characteristic	Symbol	Conditions	Min	Typ	Max	Unit
----------------	--------	------------	-----	-----	-----	------

GATE DRIVER (Note 3)

Backdrive Diode Voltage Drop	$V_{d,bd}$	$V_{\text{DRV}} - V_{\text{OUT}}$, $I_{d,bd} = 5\text{ mA}$	-	-	0.7	V
Driving Voltage	V_{DRV}	$I_{\text{VDRV}} = 0.1 - 25\text{ mA}$ NCV887601	5.8	6.0	6.2	V

UVLO

Undervoltage Lock-out, Threshold Voltage	$V_{\text{uvlo,fall}}$	VOUT falling	3.4	3.59	3.8	V
Undervoltage Lock-out	$V_{\text{uvlo,rise}}$	VOUT rising	3.90	4.05	4.20	V

THERMAL SHUTDOWN

Thermal Shutdown Threshold (Note 2)	T_{sd}	T_J rising	160	170	180	$^{\circ}\text{C}$
Thermal Shutdown Hysteresis (Note 2)	$T_{\text{sd,hys}}$	T_J falling	10	15	20	$^{\circ}\text{C}$
Thermal Shutdown Delay (Note 2)	$t_{\text{sd,dly}}$	From $T_J > T_{\text{sd}}$ to stop switching	-	-	100	ns

VOLTAGE REGULATION

Voltage Regulation	$V_{\text{OUT,reg}}$	NCV887601	6.66	6.8	6.94	V
Threshold IC Enable		VOUT descending NCV887601	7.1	7.3	7.5	V
Threshold IC Disable		VOUT ascending NCV887601	7.5	7.7	7.9	V
Threshold IC Enable – Voltage Regulation		NCV887601	0.32	0.5	-	V
Threshold IC Disable – Threshold IC Enable		NCV887601	-	0.4	-	V

Product parametric performance is indicated in the Electrical Characteristics for the listed test conditions, unless otherwise noted. Product performance may not be indicated by the Electrical Characteristics if operated under different conditions.

2. Not tested in production. Limits are guaranteed by design.

3. An $R_{\text{GND}} = 15\text{ k}\Omega$ GDRV-GND resistor is strongly recommended.

TYPICAL CHARACTERISTICS

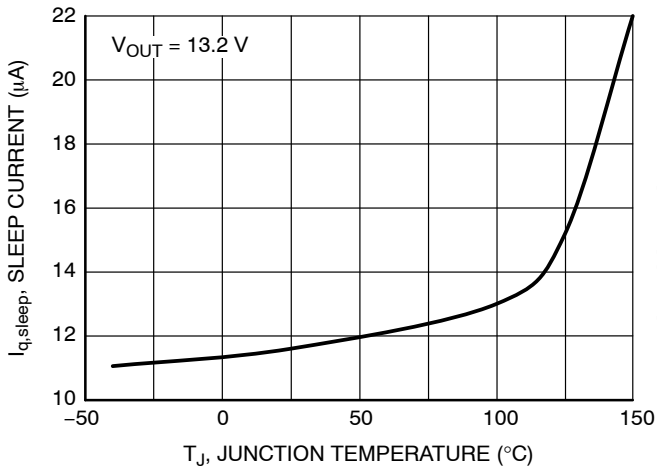

Figure 3. Sleep Current vs. Temperature

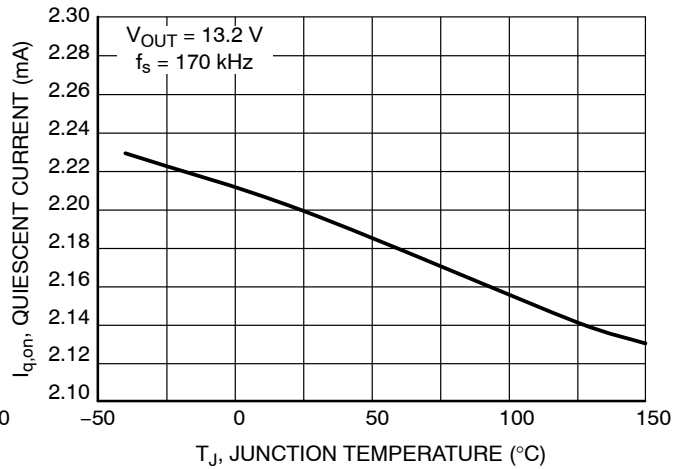

Figure 4. Quiescent Current vs. Temperature

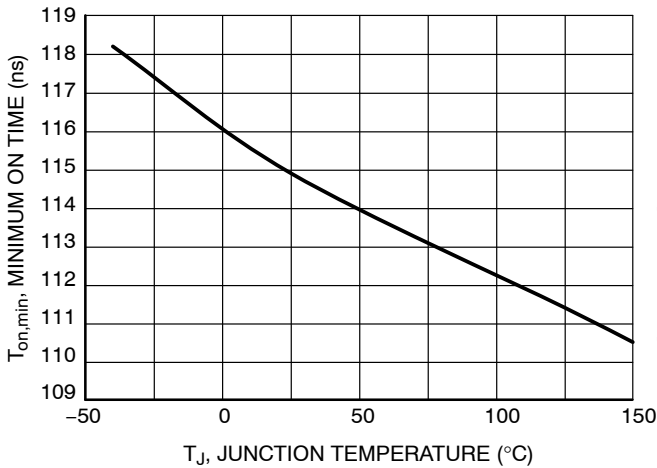

Figure 5. Minimum On Time vs. Temperature

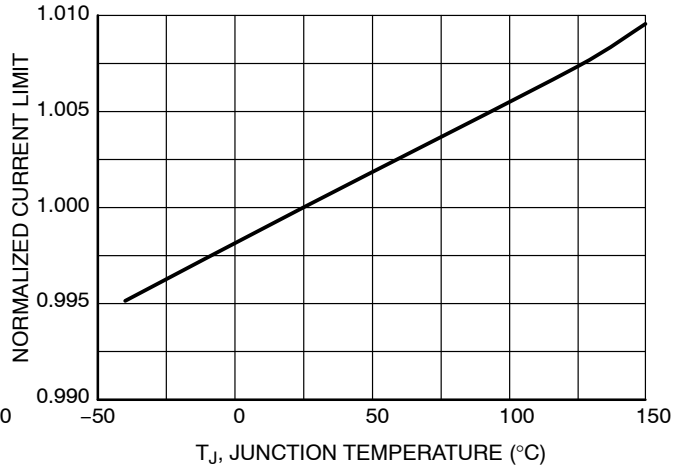

Figure 6. Normalized Current vs. Temperature

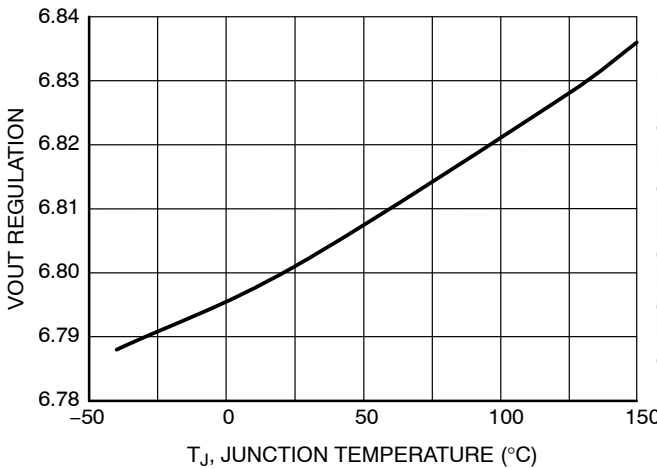

Figure 7. VOUT Regulation vs. Temperature

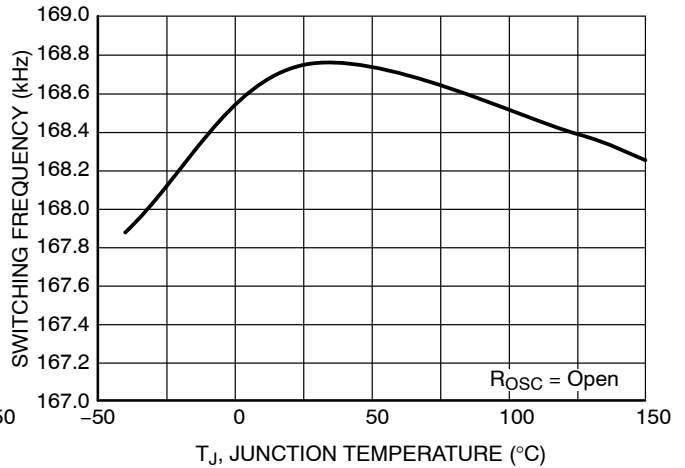

Figure 8. Switching Frequency vs. Temperature

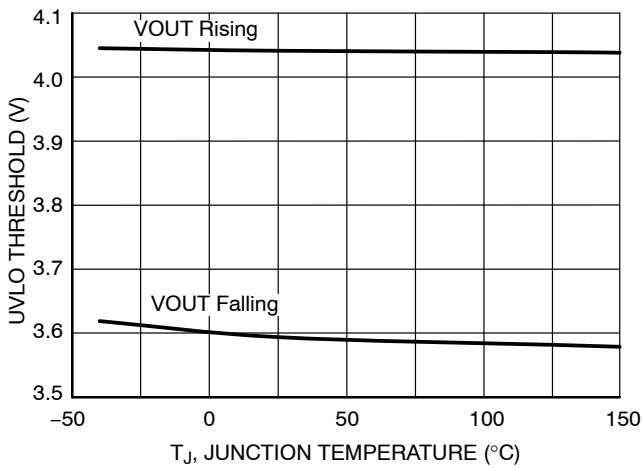

Figure 9. UVLO Threshold vs. Temperature

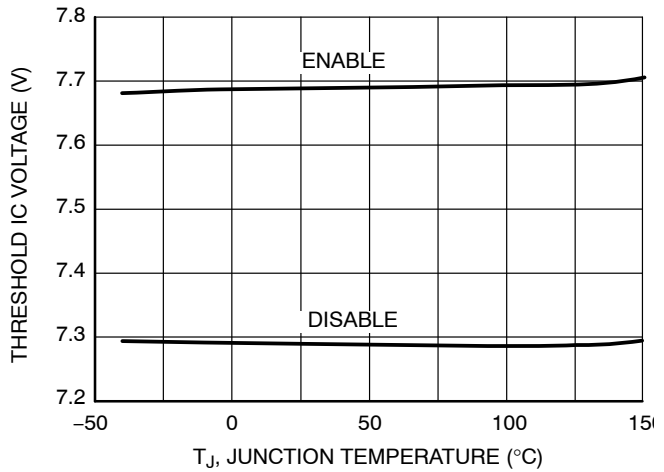

Figure 10. Threshold IC Voltage vs. Temperature

THEORY OF OPERATION

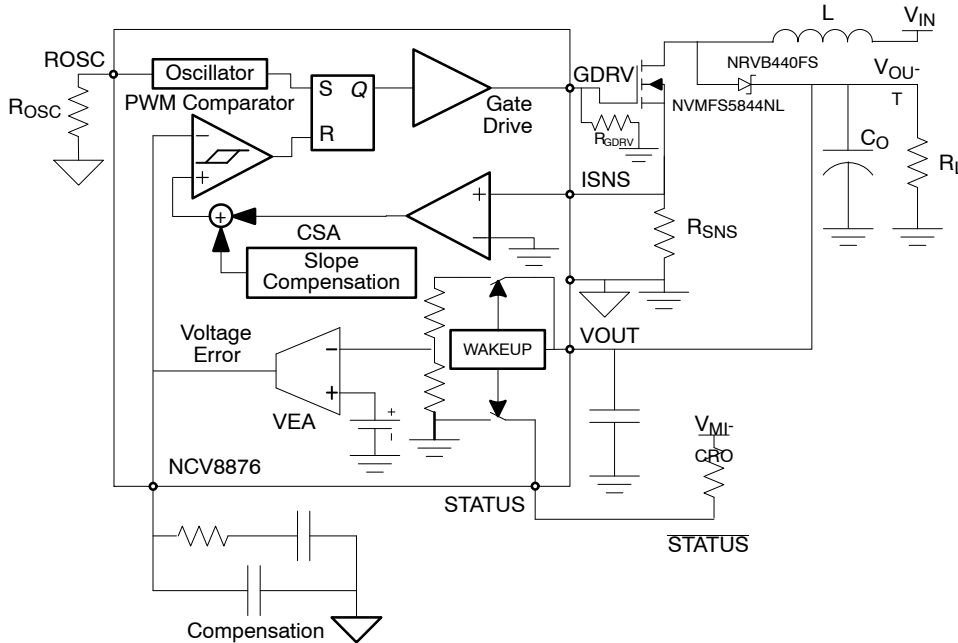

Figure 11. Current Mode Control Schematic

Regulation

The NCV8876 is a non-synchronous boost controller designed to supply a minimum output voltage during Start-Stop vehicle operation battery voltage sags. The NCV8876 is in low quiescent current sleep mode under normal battery operation (12 V) and is enabled when the supply voltage drops below the descending threshold (7.3 V for the NCV887601). Boost operation is initiated when the supply voltage is below the regulation set point (6.8 V for the NCV887601). Once the supply voltage sag condition ends and begins to increase, the NCV8876 boost operation will cease when the supply voltage increases beyond the regulation set point. The NCV8876 low quiescent current sleep mode resumes once the supply voltage increases

beyond the ascending voltage threshold (7.7 V for the NCV887600).

The NCV8876 VOUT pin serves the dual purpose: (1) powering the NCV8876 and (2) providing the regulation feedback signal. The feedback network is imbedded within the IC to eliminate the constant current battery drain that would exist with the use of external voltage feedback resistors.

There is no soft-start operating mode. The NCV8876 will instantly respond to a voltage sag so as to maintain normal operation of downstream loads. Once the NCV8876 is enabled, the voltage error operational transconductance amplifier supplies current to set VC to 1.1 V to minimize the feedback loop response time when the battery voltage sag goes below the regulation set point.

Current Mode Control

The NCV8876 incorporates a current mode control scheme, in which the PWM ramp signal is derived from the power switch current. This ramp signal is compared to the output of the error amplifier to control the on-time of the power switch. The oscillator is used as a fixed-frequency clock to ensure a constant operational frequency. The resulting control scheme features several advantages over conventional voltage mode control. First, derived directly from the inductor, the ramp signal responds immediately to line voltage changes. This eliminates the delay caused by the output filter and the error amplifier, which is commonly found in voltage mode controllers. The second benefit comes from inherent pulse-by-pulse current limiting by merely clamping the peak switching current. Finally, since current mode commands an output current rather than voltage, the filter offers only a single pole to the feedback loop. This allows for a simpler compensation.

The NCV8876 also includes a slope compensation scheme in which a fixed ramp generated by the oscillator is added to the current ramp. A proper slope rate is provided to improve circuit stability without sacrificing the advantages of current mode control.

Current Limit

The NCV8876 features two current limit protections, peak current mode and over current latch off. When the current sense amplifier detects a voltage above the peak current limit between ISNS and GND after the current limit leading edge blanking time, the peak current limit causes the

power switch to turn off for the remainder of the cycle. Set the current limit with a resistor from ISNS to GND, with $R = V_{CL} / I_{limit}$.

If the voltage across the current sense resistor exceeds the over current threshold voltage the device enters over current hiccup mode. The device will remain off for the hiccup time of duration $1024/f_{osc}$.

UVLO

Input Undervoltage Lockout (UVLO) is provided to ensure that unexpected behavior does not occur when VIN is too low to support the internal rails and power the controller. The IC will start up when enabled and VIN surpasses the UVLO threshold plus the UVLO hysteresis and will shut down when VIN drops below the UVLO threshold or the part is disabled.

VDRV

An internal regulator provides the drive voltage for the gate driver. Bypass with a ceramic capacitor to ground to ensure fast turn on times. The capacitor should be between 0.1 μF and 1 μF, depending on switching speed and charge requirements of the external MOSFET.

VDRV uses an internal linear regulator to charge the VDRV bypass capacitor. VOUT must be decoupled at the IC by a capacitor that is equal or larger in value than the VDRV decoupling capacitor.

GDRV

An $R_{GND} = 15 \text{ k}\Omega$ GDRV-GND resistor is strongly recommended.

APPLICATION INFORMATION

Design Methodology

This section details an overview of the component selection process for the NCV8876 in continuous conduction mode boost. It is intended to assist with the design process but does not remove all engineering design work. Many of the equations make heavy use of the small ripple approximation.

This process entails the following steps:

1. Define Operational Parameters
2. Select Operating Frequency
3. Select Current Sense Resistor
4. Select Output Inductor
5. Select Output Capacitors
6. Select Input Capacitors
7. Select Compensator Components
8. Select MOSFET(s)
9. Select Diode
10. Design Notes
11. Determine Feedback Loop Compensation Network

1. Define Operational Parameters

Before beginning the design, define the operating parameters of the application. These include:

- $V_{IN(min)}$: minimum input voltage [V]
- $V_{IN(max)}$: maximum input voltage [V]
- V_{OUT} : output voltage [V]

$I_{OUT(max)}$: maximum output current [A]

I_{CL} : desired typical cycle-by-cycle current limit [A]

From this the ideal minimum and maximum duty cycles can be calculated as follows:

$$D_{min} = 1 - \frac{V_{IN(max)}}{V_{OUT}}$$

$$D_{max} = 1 - \frac{V_{IN(min)}}{V_{OUT}}$$

Both duty cycles will actually be higher due to power loss in the conversion. The exact duty cycles will depend on conduction and switching losses. If the maximum input voltage is higher than the output voltage, the minimum duty cycle will be negative. This is because a boost converter cannot have an output lower than the input. In situations where the input is higher than the output, the output will follow the input, minus the diode drop of the output diode and the converter will not attempt to switch.

If the calculated D_{max} is higher the D_{max} of the NCV8876, the conversion will not be possible. It is important for a boost converter to have a restricted D_{max} , because while the ideal conversion ration of a boost converter goes up to infinity as

D approaches 1, a real converter's conversion ratio starts to decrease as losses overtake the increased power transfer. If the converter is in this range it will not be able to regulate properly.

If the following equation is not satisfied, the device will skip pulses at high V_{IN} :

$$\frac{D_{min}}{f_s} \geq t_{on(min)}$$

Where: f_s : switching frequency [Hz]

$t_{on(min)}$: minimum on time [s]

2. Select Operating Frequency

The default setting is an open ROSC pin, allowing the oscillator to operate at the default frequency F_s . Adding a resistor to GND increases the switching frequency.

The graph in Figure 12, below, shows the required resistance to program the frequency. From 200 kHz to 500 kHz, the following formula is accurate to within 3% of the expected.

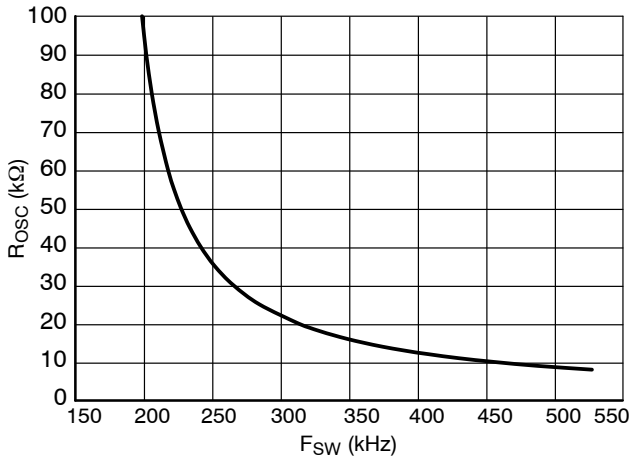

Figure 12. R_{osc} vs. F_{sw}

$$R_{osc} = \frac{2859}{(F_{sw} - 170)}$$

Where: f_{sw} : switching frequency [kHz]

R_{osc} : resistor from ROSC pin to GND [k]

Note: The R_{osc} resistor ground return to the NCV8876 pin 3 must be independent of power grounds.

3. Select Current Sense Resistor

Current sensing for peak current mode control and current limit relies on the MOSFET current signal, which is measured with a ground referenced amplifier. The easiest method of generating this signal is to use a current sense resistor from the source of the MOSFET to device ground. The sense resistor should be selected as follows:

$$R_s = \frac{V_{CL}}{I_{CL}}$$

Where: R_s : sense resistor [Ω]

V_{CL} : current limit threshold voltage [V]

I_{CL} : desire current limit [A]

4. Select Output Inductor

The output inductor controls the current ripple that occurs over a switching period. A high current ripple will result in excessive power loss and ripple current requirements. A low current ripple will result in a poor control signal and a slow current slew rate in case of load steps. A good starting point for peak to peak ripple is around 20–40% of the inductor current at the maximum load at the worst case V_{IN} , but operation should be verified empirically. The worst case V_{IN} is half of V_{OUT} , or whatever V_{IN} is closest to half of V_{OUT} . After choosing a peak current ripple value, calculate the inductor value as follows:

$$L = \frac{V_{IN(WC)} D_{WC}}{\Delta I_{L,max} f_s}$$

Where: $V_{IN(WC)}$: V_{IN} value as close as possible to half of V_{OUT} [V]

D_{WC} : duty cycle at $V_{IN(WC)}$

$\Delta I_{L,max}$: maximum peak to peak ripple [A]

The maximum average inductor current can be calculated as follows:

$$I_{L,AVG} = \frac{V_{OUT} I_{OUT(max)}}{V_{IN(min)} \eta}$$

The Peak Inductor current can be calculated as follows:

$$I_{L,peak} = I_{L,avg} + \frac{\Delta I_{L,max}}{2}$$

Where: $I_{L,peak}$: Peak inductor current value [A]

5. Select Output Capacitors

The output capacitors smooth the output voltage and reduce the overshoot and undershoot associated with line transients. The steady state output ripple associated with the output capacitors can be calculated as follows:

$V_{OUT(ripple)} =$

$$\frac{D I_{OUT(max)}}{f C_{OUT}} + \left(\frac{I_{OUT(max)}}{1 - D} + \frac{V_{IN(min)} D}{2fL} \right) R_{ESR}$$

The capacitors need to survive an RMS ripple current as follows:

$$I_{Cout(RMS)} = I_{OUT} \sqrt{\frac{D_{WC}}{D'_{WC}} + \frac{D_{WC}}{12} \left(\frac{D'_{WC}}{\frac{L}{R_{OUT} \times T_{SW}}} \right)^2}$$

The use of parallel ceramic bypass capacitors is strongly encouraged to help with the transient response.

6. Select Input Capacitors

The input capacitor reduces voltage ripple on the input to the module associated with the ac component of the input current.

$$I_{Cin(RMS)} = \frac{V_{IN(WC)}^2 D_{WC}}{L_f s V_{OUT} 2\sqrt{3}}$$

7. Select Compensator Components

Current Mode control method employed by the NCV8876 allows the use of a simple, Type II compensation to optimize the dynamic response according to system requirements.

8. Select MOSFET(s)

In order to ensure the gate drive voltage does not drop out the MOSFET(s) chosen must not violate the following inequality:

$$Q_{g(total)} \leq \frac{I_{drv}}{f_s}$$

Where: $Q_{g(total)}$: Total Gate Charge of MOSFET(s) [C]

I_{drv} : Drive voltage current [A]

f_s : Switching Frequency [Hz]

The maximum RMS Current can be calculated as follows:

$$I_{Q(max)} = I_{out} \sqrt{\frac{D}{D'}}$$

The maximum voltage across the MOSFET will be the maximum output voltage, which is the higher of the maximum input voltage and the regulated output voltage:

$$V_{Q(max)} = V_{OUT(max)}$$

NVMFS5844NL 12 mΩ, 60 V SO-8FL package MOSFET is a recommended device.

9. Select Diode

The output diode rectifies the output current. The average current through diode will be equal to the output current:

$$I_{D(avg)} = I_{OUT(max)}$$

Additionally, the diode must block voltage equal to the higher of the output voltage and the maximum input voltage:

$$V_{D(max)} = V_{OUT(max)}$$

The maximum power dissipation in the diode can be calculated as follows:

$$P_D = V_{f(max)} I_{OUT(max)}$$

Where: P_d : Power dissipation in the diode [W]

$V_{f(max)}$: Maximum forward voltage of the diode [V]

The 4 amp, 40 V NRVB440MFS SO-8FL package Schottky diode is a recommended device.

10. Design Notes

- VOUT serves a dual purpose (feedback and IC power). The VDRV circuit has a current pulse power draw resulting in current flow from the output sense location to the IC. Trace ESL will cause voltage ripple to

develop at IC pin VOUT which could affect performance.

- ♦ Use a 1 μF IC VOUT pin decoupling capacitor close to IC in addition to the VDRV decoupling capacitor.
- Classic feedback loop measurements are not possible (VOUT pin serves a dual purpose as a feedback path and IC power). Feedback loop computer modeling recommended.
 - ♦ A step load test for stability verification is recommended.
- Compensation ground must be dedicated and connected directly to IC ground.
 - ♦ Do not use vias. Use a dedicated ground trace.
- ROsc programming resistor ground must be dedicated and connected directly to IC ground
 - ♦ Do not use vias. Use a dedicated ground trace.
- IC ground & current sense resistor ground sense point must be located on the same side of PCB.
 - ♦ Vias introduce sufficient ESR/ESL voltage drop which can degrade the accuracy of the current feedback signal amplitude (signal bounce) and should be avoided.
- Star ground should be located at IC ground pad.
 - ♦ This is the location for connecting the compensation and current sense grounds.
- The IC architecture has a leading edge ISNS blanking circuit. In some instances, current pulse leading edge current spike RC filter may be required.
 - ♦ If required, 120 pF + 750 Ω are a recommended evaluation starting point.

11. Determine Feedback Loop Compensation Network

The purpose of a compensation network is to stabilize the dynamic response of the converter. By optimizing the compensation network, stable regulation response is achieved for input line and load transients.

Compensator design involves the placement of poles and zeros in the closed loop transfer function. Losses from the boost inductor, MOSFET, current sensing and boost diode losses also influence the gain and compensation expressions. The OTA has an ESD protection structure ($R_{ESD} \approx 502 \Omega$, data not provided in the datasheet) located on the die between the OTA output and the IC package compensation pin (VC). The information from the OTA PWM feedback control signal (V_{CTRL}) may differ from the IC-VC signal if R_2 is of similar order of magnitude as R_{ESD} . The compensation and gain expressions which follow take influence from the OTA output impedance elements into account.

Type-I compensation is not possible due to the presence of R_{ESD} . The Figure 13 compensation network corresponds to a Type-II network in series with R_{ESD} . The resulting control-output transfer function is an accurate mathematical model of the IC in a boost converter topology. The model

NCV8876

does have limitations and a more accurate SPICE model should be considered for a more detailed analysis:

- The attenuating effect of large value ceramic capacitors in parallel with output electrolytic capacitor ESR is not considered in the equations.
- The efficiency term η should be a reasonable operating condition estimate.

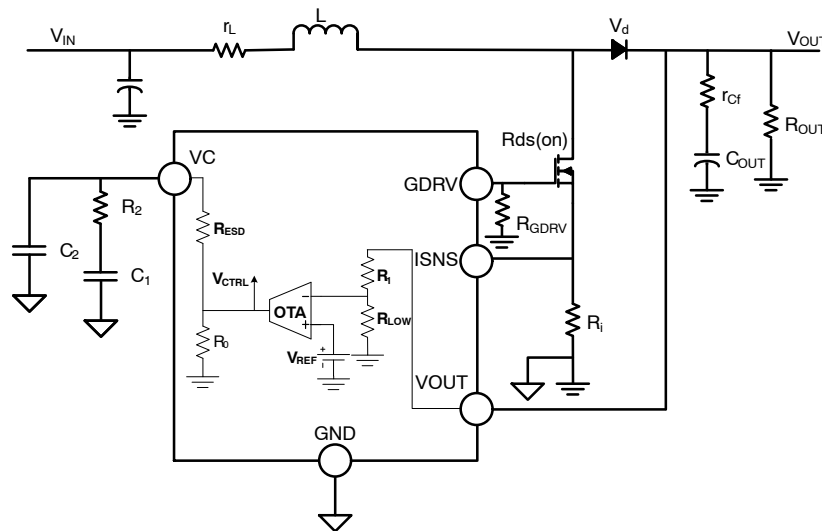

Figure 13. NCV8876 OTA and Compensation

A worksheet as well as a SPICE model which may be used for selecting compensation components R_2 , C_1 , C_2 is available at the **onsemi** web site (<http://onsemi.com/PowerSolutions/product.do?id=NCV8876>). The following equations may be used to analyze the Figure 10 boost converter. Required input design parameters for analysis are:

- V_d = Boost diode V_f (V)
- V_{IN} = Boost supply input voltage (V)
- R_i = Current sense resistor (Ω)
- $R_{DS(on)}$ = MOSFET $R_{DS(on)}$ (Ω)
- C_{OUT} = Bulk output capacitor value (F)
- $R_{sw_eq} = R_{DS(on)} + R_i$, for the boost continuous conduction mode (CCM) expressions
- r_{CF} = Bulk output capacitor ESR (Ω)

- R_{OUT} = Equivalent resistance of output load (Ω)
- P_{out} = Output Power (W)
- L = Boost inductor value (H)
- r_L = Boost inductor ESR (Ω)
- $T_s = 1/f_s$, where f_s = clock frequency (Hz)
- V_{OUT} = Device specific output voltage (e.g. 6.8 V for NCV887601) (V)
- V_{ref} = OTA internal voltage reference = 1.2 V
- R_0 = OTA output resistance = 3 M Ω
- S_a = IC slope compensation (e.g. 53 mV/ μ s for NCV887601)
- g_m = OTA transconductance = 1.2 mS
- D = Controller duty ratio
- $D' = 1 - D$

Necessary equations for describing the modulator gain ($V_{ctrl-to-V_{out}}$ gain) $H_{ctrl_output}(f)$ are described in Table 1.

Table 1. BOOST CCM TRANSFER FUNCTION EXPRESSIONS

Duty ratio (D)	$\frac{\left[\begin{array}{c} 2R_{OUT}V_dV_{IN} - \left[R_{sw_eq} + R_{OUT} \left(\frac{V_{IN}}{V_{OUT}} - 2 \right) \right] V_{OUT}^2 \\ -V_{OUT} \sqrt{R_{OUT} \left(\frac{R_{OUT}V_{IN}^2 + 2R_{sw_eq}V_{IN}V_{OUT} - 4V_dR_{sw_eq}V_{IN}}{-4R_{sw_eq}V_{OUT}^2 - 4r_LV_dV_{IN} - 4r_LV_{OUT}^2} \right) + R_{sw_eq}^2V_{OUT}^2} \end{array} \right]}{2R_{OUT}(V_{OUT}^2 + V_dV_{IN})}$
V _{out} /V _{in} DC Conversion Ratio (M)	$\frac{1}{1-D} \left[1 - \frac{(1-D)V_d}{V_{OUT}} \right] \left[\frac{1}{1 + \frac{1}{(1-D)^2 \left(\frac{r_L + DR_{sw_eq}}{R_{OUT}} \right)}} \right]$
Average Inductor Current (I _{lave})	$\frac{P_{OUT}}{V_{IN}\eta}$
Inductor On-slope (S _n)	$\frac{V_{IN} - I_{Lave}(r_L + R_{sw_eq})}{L} R_i$
Compensation Ramp (m _c)	$1 + \frac{S_a}{S_n}$
C _{out} ESR Zero (ω _{z1})	$\frac{1}{r_{CF}C_{OUT}}$
Right-half-plane Zero (ω _{z2})	$\frac{(1-D)^2}{L} \left(R_{OUT} - \frac{r_{CF}R_{OUT}}{r_{CF} + R_{OUT}} \right) - \frac{r_L}{L}$
Low Frequency Modulator Pole (ω _{p1})	$\frac{\frac{2}{R_{OUT}} + \frac{T_s}{LM^3} m_c}{C_{OUT}}$
Sampling Double Pole (ω _n)	$\frac{\pi}{T_s}$
Sampling Quality Coefficient (Q _p)	$\frac{1}{\pi(m_c(1-D) - 0.5)}$
F _m	$\frac{1}{2M + \frac{R_{OUT}T_s}{LM^2} \left(\frac{1}{2} + \frac{S_a}{S_n} \right)}$
H _d	$\frac{\eta R_{OUT}}{R_i}$
Control-output Transfer Function (H _{ctrl_output} (f))	$F_m H_d \frac{\left(1 + j \frac{2\pi f}{\omega_{z1}} \right)}{\left(1 + j \frac{2\pi f}{\omega_{p1}} \right)} \frac{\left(1 - j \frac{2\pi f}{\omega_{z2}} \right)}{\left(1 + j \frac{2\pi f}{\omega_n Q_p} + \left(j \frac{2\pi f}{\omega_n} \right)^2 \right)}$

Once the desired cross-over frequency (f_c) gain adjustment and necessary phase boost are determined from the H_{ctrl_output}(f) gain and phase plots, the Table 2 equations may be used. It should be noted that minor compensation component value adjustments may become necessary when R₂ ≤ ~10 · R_{esd} as a result of approximations for determining components R₂, C₁, C₂.

Table 2. OTA COMPENSATION TRANSFER FUNCTION AND COMPENSATION VALUES

Desired OTA Gain at Cross-over Frequency f_c (G)	$\frac{\text{desired } G_{fc_gain_db}}{10^{\frac{20}{20}}}$
Desired Phase Boost at Cross-over Frequency f_c (boost)	$\left(\theta_{\text{margin}} - \arg(H_{\text{ctrl_output}}(fc)) \frac{180^\circ}{\pi} - 90^\circ \right) \frac{\pi}{180^\circ}$
Select OTA Compensation Zero to Coincide with Modulator Pole at f_{p1} (f_z)	$\frac{\omega_{p1e}}{2\pi}$
Resulting OTA High Frequency Pole Placement (f_p)	$\frac{f_z f_c + f_c^2 \tan(\text{boost})}{f_c - f_z \tan(\text{boost})}$
Compensation Resistor (R_2)	$\frac{f_p G}{f_p - f_z} \frac{V_{\text{OUT}}}{1.2 g_m} \frac{\sqrt{1 + \left(\frac{f_c}{f_p}\right)^2}}{\sqrt{1 + \left(\frac{f_z}{f_p}\right)^2}}$
Compensation Capacitor (C_1)	$\frac{1}{2\pi f_z R_2}$
Compensation Capacitor (C_2)	$\frac{1}{2\pi f_p G} \frac{1.2 g_m}{V_{\text{OUT}}}$
OTA DC Gain (G_{0_OTA})	$\frac{V_{\text{ref}}}{V_{\text{OUT}}} g_m R_0$
Low Frequency Zero (ω_{z1e})	$\frac{1}{2} \frac{(R_2 + R_{\text{esd}})}{R_2 R_{\text{esd}} C_2} \left[1 - \sqrt{1 - 4 \frac{R_2 R_{\text{esd}} C_2}{(R_2 + R_{\text{esd}})^2 C_1}} \right]$
High Frequency Zero (ω_{z2e})	$\frac{1}{2} \frac{(R_2 + R_{\text{esd}})}{R_2 R_{\text{esd}} C_2} \left[1 + \sqrt{1 - 4 \frac{R_2 R_{\text{esd}} C_2}{(R_2 + R_{\text{esd}})^2 C_1}} \right]$
Low Frequency Pole (ω_{p1e})	$\frac{1}{2} \frac{(R_0 + R_2 + R_{\text{esd}})}{R_2 (R_0 + R_{\text{esd}}) C_2} \left[1 - \sqrt{1 - 4 \frac{R_2 (R_0 + R_{\text{esd}}) C_2}{(R_0 + R_2 + R_{\text{esd}})^2 C_1}} \right]$
High Frequency Pole (ω_{p2e})	$\frac{1}{2} \frac{(R_0 + R_2 + R_{\text{esd}})}{R_2 (R_0 + R_{\text{esd}}) C_2} \left[1 + \sqrt{1 - 4 \frac{R_2 (R_0 + R_{\text{esd}}) C_2}{(R_0 + R_2 + R_{\text{esd}})^2 C_1}} \right]$
OTA Transfer Function ($G_{\text{OTA}}(f)$)	$-G_{0_OTA} \frac{1 + j \frac{2\pi f}{\omega_{z1e}}}{1 + j \frac{2\pi f}{\omega_{p1e}}} \frac{1 + j \frac{2\pi f}{\omega_{z2e}}}{1 + j \frac{2\pi f}{\omega_{p2e}}}$

The open-loop-response in closed-loop form to verify the gain/phase margins may be obtained from the following expressions.

$$T(f) = G_{\text{OTA}}(f) H_{\text{ctrl_output}}(f)$$

MECHANICAL CASE OUTLINE PACKAGE DIMENSIONS



SCALE 1:1

SOIC-8 NB
CASE 751-07
ISSUE AK

DATE 16 FEB 2011



- NOTES:
1. DIMENSIONING AND TOLERANCING PER ANSI Y14.5M, 1982.
 2. CONTROLLING DIMENSION: MILLIMETER.
 3. DIMENSION A AND B DO NOT INCLUDE MOLD PROTRUSION.
 4. MAXIMUM MOLD PROTRUSION 0.15 (0.006) PER SIDE.
 5. DIMENSION D DOES NOT INCLUDE DAMBAR PROTRUSION. ALLOWABLE DAMBAR PROTRUSION SHALL BE 0.127 (0.005) TOTAL IN EXCESS OF THE D DIMENSION AT MAXIMUM MATERIAL CONDITION.
 6. 751-01 THRU 751-06 ARE OBSOLETE. NEW STANDARD IS 751-07.

DIM	MILLIMETERS		INCHES	
	MIN	MAX	MIN	MAX
A	4.80	5.00	0.189	0.197
B	3.80	4.00	0.150	0.157
C	1.35	1.75	0.053	0.069
D	0.33	0.51	0.013	0.020
G	1.27 BSC		0.050 BSC	
H	0.10	0.25	0.004	0.010
J	0.19	0.25	0.007	0.010
K	0.40	1.27	0.016	0.050
M	0°	8°	0°	8°
N	0.25	0.50	0.010	0.020
S	5.80	6.20	0.228	0.244

SOLDERING FOOTPRINT*

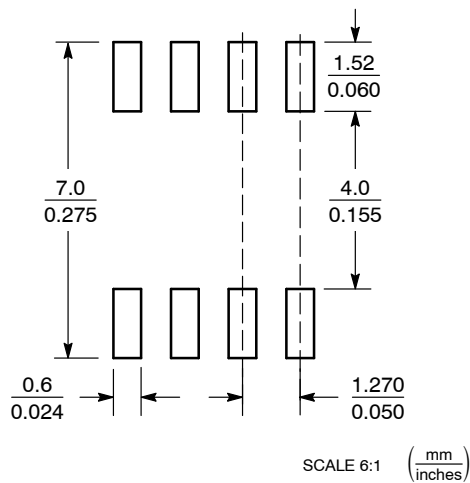

*For additional information on our Pb-Free strategy and soldering details, please download the ON Semiconductor Soldering and Mounting Techniques Reference Manual, SOLDERRM/D.

GENERIC MARKING DIAGRAM*



XXXXXX = Specific Device Code
 A = Assembly Location
 L = Wafer Lot
 Y = Year
 W = Work Week
 ■ = Pb-Free Package

XXXXXX = Specific Device Code
 A = Assembly Location
 Y = Year
 WW = Work Week
 ■ = Pb-Free Package

*This information is generic. Please refer to device data sheet for actual part marking. Pb-Free indicator, "G" or microdot "•", may or may not be present. Some products may not follow the Generic Marking.

STYLES ON PAGE 2

DOCUMENT NUMBER:	98ASB42564B	Electronic versions are uncontrolled except when accessed directly from the Document Repository. Printed versions are uncontrolled except when stamped "CONTROLLED COPY" in red.
DESCRIPTION:	SOIC-8 NB	PAGE 1 OF 2

onsemi and ONSEMI are trademarks of Semiconductor Components Industries, LLC dba onsemi or its subsidiaries in the United States and/or other countries. onsemi reserves the right to make changes without further notice to any products herein. onsemi makes no warranty, representation or guarantee regarding the suitability of its products for any particular purpose, nor does onsemi assume any liability arising out of the application or use of any product or circuit, and specifically disclaims any and all liability, including without limitation special, consequential or incidental damages. onsemi does not convey any license under its patent rights nor the rights of others.

SOIC-8 NB
CASE 751-07
ISSUE AK

DATE 16 FEB 2011

- | | | | |
|---|--|--|--|
| <p>STYLE 1:
 PIN 1. EMITTER
 2. COLLECTOR
 3. COLLECTOR
 4. EMITTER
 5. EMITTER
 6. BASE
 7. BASE
 8. EMITTER</p> | <p>STYLE 2:
 PIN 1. COLLECTOR, DIE, #1
 2. COLLECTOR, #1
 3. COLLECTOR, #2
 4. COLLECTOR, #2
 5. BASE, #2
 6. EMITTER, #2
 7. BASE, #1
 8. EMITTER, #1</p> | <p>STYLE 3:
 PIN 1. DRAIN, DIE #1
 2. DRAIN, #1
 3. DRAIN, #2
 4. DRAIN, #2
 5. GATE, #2
 6. SOURCE, #2
 7. GATE, #1
 8. SOURCE, #1</p> | <p>STYLE 4:
 PIN 1. ANODE
 2. ANODE
 3. ANODE
 4. ANODE
 5. ANODE
 6. ANODE
 7. ANODE
 8. COMMON CATHODE</p> |
| <p>STYLE 5:
 PIN 1. DRAIN
 2. DRAIN
 3. DRAIN
 4. DRAIN
 5. GATE
 6. GATE
 7. SOURCE
 8. SOURCE</p> | <p>STYLE 6:
 PIN 1. SOURCE
 2. DRAIN
 3. DRAIN
 4. SOURCE
 5. SOURCE
 6. GATE
 7. GATE
 8. SOURCE</p> | <p>STYLE 7:
 PIN 1. INPUT
 2. EXTERNAL BYPASS
 3. THIRD STAGE SOURCE
 4. GROUND
 5. DRAIN
 6. GATE 3
 7. SECOND STAGE Vd
 8. FIRST STAGE Vd</p> | <p>STYLE 8:
 PIN 1. COLLECTOR, DIE #1
 2. BASE, #1
 3. BASE, #2
 4. COLLECTOR, #2
 5. COLLECTOR, #2
 6. EMITTER, #2
 7. EMITTER, #1
 8. COLLECTOR, #1</p> |
| <p>STYLE 9:
 PIN 1. EMITTER, COMMON
 2. COLLECTOR, DIE #1
 3. COLLECTOR, DIE #2
 4. EMITTER, COMMON
 5. EMITTER, COMMON
 6. BASE, DIE #2
 7. BASE, DIE #1
 8. EMITTER, COMMON</p> | <p>STYLE 10:
 PIN 1. GROUND
 2. BIAS 1
 3. OUTPUT
 4. GROUND
 5. GROUND
 6. BIAS 2
 7. INPUT
 8. GROUND</p> | <p>STYLE 11:
 PIN 1. SOURCE 1
 2. GATE 1
 3. SOURCE 2
 4. GATE 2
 5. DRAIN 2
 6. DRAIN 2
 7. DRAIN 1
 8. DRAIN 1</p> | <p>STYLE 12:
 PIN 1. SOURCE
 2. SOURCE
 3. SOURCE
 4. GATE
 5. DRAIN
 6. DRAIN
 7. DRAIN
 8. DRAIN</p> |
| <p>STYLE 13:
 PIN 1. N.C.
 2. SOURCE
 3. SOURCE
 4. GATE
 5. DRAIN
 6. DRAIN
 7. DRAIN
 8. DRAIN</p> | <p>STYLE 14:
 PIN 1. N-SOURCE
 2. N-GATE
 3. P-SOURCE
 4. P-GATE
 5. P-DRAIN
 6. P-DRAIN
 7. N-DRAIN
 8. N-DRAIN</p> | <p>STYLE 15:
 PIN 1. ANODE 1
 2. ANODE 1
 3. ANODE 1
 4. ANODE 1
 5. CATHODE, COMMON
 6. CATHODE, COMMON
 7. CATHODE, COMMON
 8. CATHODE, COMMON</p> | <p>STYLE 16:
 PIN 1. EMITTER, DIE #1
 2. BASE, DIE #1
 3. EMITTER, DIE #2
 4. BASE, DIE #2
 5. COLLECTOR, DIE #2
 6. COLLECTOR, DIE #2
 7. COLLECTOR, DIE #1
 8. COLLECTOR, DIE #1</p> |
| <p>STYLE 17:
 PIN 1. VCC
 2. V2OUT
 3. V1OUT
 4. TXE
 5. RXE
 6. VEE
 7. GND
 8. ACC</p> | <p>STYLE 18:
 PIN 1. ANODE
 2. ANODE
 3. SOURCE
 4. GATE
 5. DRAIN
 6. DRAIN
 7. CATHODE
 8. CATHODE</p> | <p>STYLE 19:
 PIN 1. SOURCE 1
 2. GATE 1
 3. SOURCE 2
 4. GATE 2
 5. DRAIN 2
 6. MIRROR 2
 7. DRAIN 1
 8. MIRROR 1</p> | <p>STYLE 20:
 PIN 1. SOURCE (N)
 2. GATE (N)
 3. SOURCE (P)
 4. GATE (P)
 5. DRAIN
 6. DRAIN
 7. DRAIN
 8. DRAIN</p> |
| <p>STYLE 21:
 PIN 1. CATHODE 1
 2. CATHODE 2
 3. CATHODE 3
 4. CATHODE 4
 5. CATHODE 5
 6. COMMON ANODE
 7. COMMON ANODE
 8. CATHODE 6</p> | <p>STYLE 22:
 PIN 1. I/O LINE 1
 2. COMMON CATHODE/VCC
 3. COMMON CATHODE/VCC
 4. I/O LINE 3
 5. COMMON ANODE/GND
 6. I/O LINE 4
 7. I/O LINE 5
 8. COMMON ANODE/GND</p> | <p>STYLE 23:
 PIN 1. LINE 1 IN
 2. COMMON ANODE/GND
 3. COMMON ANODE/GND
 4. LINE 2 IN
 5. LINE 2 OUT
 6. COMMON ANODE/GND
 7. COMMON ANODE/GND
 8. LINE 1 OUT</p> | <p>STYLE 24:
 PIN 1. BASE
 2. EMITTER
 3. COLLECTOR/ANODE
 4. COLLECTOR/ANODE
 5. CATHODE
 6. CATHODE
 7. COLLECTOR/ANODE
 8. COLLECTOR/ANODE</p> |
| <p>STYLE 25:
 PIN 1. VIN
 2. N/C
 3. REXT
 4. GND
 5. IOUT
 6. IOUT
 7. IOUT
 8. IOUT</p> | <p>STYLE 26:
 PIN 1. GND
 2. dv/dt
 3. ENABLE
 4. ILIMIT
 5. SOURCE
 6. SOURCE
 7. SOURCE
 8. VCC</p> | <p>STYLE 27:
 PIN 1. ILIMIT
 2. OVLO
 3. UVLO
 4. INPUT+
 5. SOURCE
 6. SOURCE
 7. SOURCE
 8. DRAIN</p> | <p>STYLE 28:
 PIN 1. SW_TO_GND
 2. DASIC_OFF
 3. DASIC_SW_DET
 4. GND
 5. V_MON
 6. VBULK
 7. VBULK
 8. VIN</p> |
| <p>STYLE 29:
 PIN 1. BASE, DIE #1
 2. EMITTER, #1
 3. BASE, #2
 4. EMITTER, #2
 5. COLLECTOR, #2
 6. COLLECTOR, #2
 7. COLLECTOR, #1
 8. COLLECTOR, #1</p> | <p>STYLE 30:
 PIN 1. DRAIN 1
 2. DRAIN 1
 3. GATE 2
 4. SOURCE 2
 5. SOURCE 1/DRAIN 2
 6. SOURCE 1/DRAIN 2
 7. SOURCE 1/DRAIN 2
 8. GATE 1</p> | | |

DOCUMENT NUMBER:	98ASB42564B	Electronic versions are uncontrolled except when accessed directly from the Document Repository. Printed versions are uncontrolled except when stamped "CONTROLLED COPY" in red.
DESCRIPTION:	SOIC-8 NB	PAGE 2 OF 2

onsemi and **ONSEMI** are trademarks of Semiconductor Components Industries, LLC dba **onsemi** or its subsidiaries in the United States and/or other countries. **onsemi** reserves the right to make changes without further notice to any products herein. **onsemi** makes no warranty, representation or guarantee regarding the suitability of its products for any particular purpose, nor does **onsemi** assume any liability arising out of the application or use of any product or circuit, and specifically disclaims any and all liability, including without limitation special, consequential or incidental damages. **onsemi** does not convey any license under its patent rights nor the rights of others.

onsemi, **Onsemi**, and other names, marks, and brands are registered and/or common law trademarks of Semiconductor Components Industries, LLC dba "**onsemi**" or its affiliates and/or subsidiaries in the United States and/or other countries. **onsemi** owns the rights to a number of patents, trademarks, copyrights, trade secrets, and other intellectual property. A listing of **onsemi**'s product/patent coverage may be accessed at www.onsemi.com/site/pdf/Patent-Marking.pdf. **onsemi** reserves the right to make changes at any time to any products or information herein, without notice. The information herein is provided "as-is" and **onsemi** makes no warranty, representation or guarantee regarding the accuracy of the information, product features, availability, functionality, or suitability of its products for any particular purpose, nor does **onsemi** assume any liability arising out of the application or use of any product or circuit, and specifically disclaims any and all liability, including without limitation special, consequential or incidental damages. Buyer is responsible for its products and applications using **onsemi** products, including compliance with all laws, regulations and safety requirements or standards, regardless of any support or applications information provided by **onsemi**. "Typical" parameters which may be provided in **onsemi** data sheets and/or specifications can and do vary in different applications and actual performance may vary over time. All operating parameters, including "Typicals" must be validated for each customer application by customer's technical experts. **onsemi** does not convey any license under any of its intellectual property rights nor the rights of others. **onsemi** products are not designed, intended, or authorized for use as a critical component in life support systems or any FDA Class 3 medical devices or medical devices with a same or similar classification in a foreign jurisdiction or any devices intended for implantation in the human body. Should Buyer purchase or use **onsemi** products for any such unintended or unauthorized application, Buyer shall indemnify and hold **onsemi** and its officers, employees, subsidiaries, affiliates, and distributors harmless against all claims, costs, damages, and expenses, and reasonable attorney fees arising out of, directly or indirectly, any claim of personal injury or death associated with such unintended or unauthorized use, even if such claim alleges that **onsemi** was negligent regarding the design or manufacture of the part. **onsemi** is an Equal Opportunity/Affirmative Action Employer. This literature is subject to all applicable copyright laws and is not for resale in any manner.

ADDITIONAL INFORMATION

TECHNICAL PUBLICATIONS:

Technical Library: www.onsemi.com/design/resources/technical-documentation
onsemi Website: www.onsemi.com

ONLINE SUPPORT: www.onsemi.com/support

For additional information, please contact your local Sales Representative at www.onsemi.com/support/sales