

NDP510A / NDP510AE / NDP510B / NDP510BE NDB510A / NDB510AE / NDB510B / NDB510BE N-Channel Enhancement Mode Field Effect Transistor

General Description

These N-channel enhancement mode power field effect transistors are produced using Fairchild's proprietary, high cell density, DMOS technology. This very high density process has been especially tailored to minimize on-state resistance, provide superior switching performance, and withstand high energy pulses in the avalanche and commutation modes. These devices are particularly suited for low voltage applications such as automotive, DC/DC converters, PWM motor controls, and other battery powered circuits where fast switching, low in-line power loss, and resistance to transients are needed.

Features

- 15 and 13A, 100V. $R_{DS(ON)} = 0.12$ and 0.15Ω .
- Critical DC electrical parameters specified at elevated temperature.
- Rugged internal source-drain diode can eliminate the need for an external Zener diode transient suppressor.
- 175°C maximum junction temperature rating.
- High density cell design (3 million/in²) for extremely low $R_{DS(ON)}$.
- TO-220 and TO-263 (D²PAK) package for both through hole and surface mount applications.

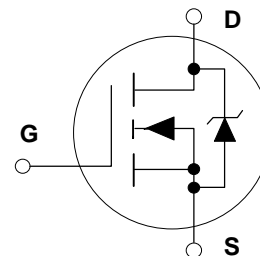
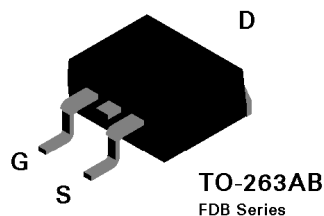
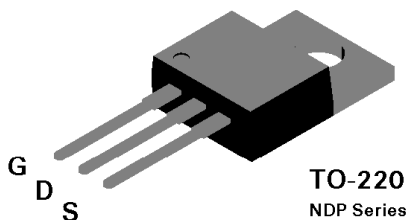

Absolute Maximum Ratings

$T_c = 25^\circ\text{C}$ unless otherwise noted

Symbol	Parameter	NDP510A	NDP510AE	NDP510B	NDP510BE	Units
		NDB510A	NDB510AE	NDB510B	NDB510BE	
V_{DSS}	Drain-Source Voltage	100				V
V_{DGR}	Drain-Gate Voltage ($R_{GS} \leq 1\text{ M}\Omega$)	100				V
V_{GSS}	Gate-Source Voltage - Continuous	± 20				V
	- Nonrepetitive ($t_p < 50\ \mu\text{s}$)	± 40				V
I_D	Drain Current - Continuous	15		13		A
	- Pulsed	60		52		A
P_D	Total Power Dissipation @ $T_c = 25^\circ\text{C}$	75				W
	Derate above 25°C	0.5				W/ $^\circ\text{C}$
T_J, T_{STG}	Operating and Storage Temperature Range	-65 to 175				$^\circ\text{C}$
T_L	Maximum lead temperature for soldering purposes, 1/8" from case for 5 seconds	275				$^\circ\text{C}$

Electrical Characteristics ($T_c = 25^\circ\text{C}$ unless otherwise noted)

Symbol	Parameter	Conditions	Type	Min	Typ	Max	Units
DRAIN-SOURCE AVALANCHE RATINGS (Note 1)							
E_{AS}	Single Pulse Drain-Source Avalanche Energy	$V_{DD} = 25\text{ V}$, $I_D = 15\text{ A}$	NDP510AE NDP510BE			65	mJ
I_{AR}	Maximum Drain-Source Avalanche Current		NDB510AE NDB510BE			15	A
OFF CHARACTERISTICS							
BV_{DSS}	Drain-Source Breakdown Voltage	$V_{GS} = 0\text{ V}$, $I_D = 250\ \mu\text{A}$	ALL	100			V
I_{DSS}	Zero Gate Voltage Drain Current	$V_{DS} = 100\text{ V}$, $V_{GS} = 0\text{ V}$ $T_J = 125^\circ\text{C}$	ALL			250	μA
						1	mA
I_{GSSF}	Gate - Body Leakage, Forward	$V_{GS} = 20\text{ V}$, $V_{DS} = 0\text{ V}$	ALL			100	nA
I_{GSSR}	Gate - Body Leakage, Reverse	$V_{GS} = -20\text{ V}$, $V_{DS} = 0\text{ V}$	ALL			-100	nA
ON CHARACTERISTICS (Note 2)							
$V_{GS(th)}$	Gate Threshold Voltage	$V_{DS} = V_{GS}$, $I_D = 250\ \mu\text{A}$ $T_J = 125^\circ\text{C}$	ALL	2	3	4	V
				1.4	2.3	3.6	V
$R_{DS(on)}$	Static Drain-Source On-Resistance	$V_{GS} = 10\text{ V}$, $I_D = 7.5\text{ A}$ $T_J = 125^\circ\text{C}$	NDP510A NDP510AE NDB510A		0.088	0.12	Ω
			NDB510AE		0.16	0.24	Ω
		$V_{GS} = 10\text{ V}$, $I_D = 6.5\text{ A}$ $T_J = 125^\circ\text{C}$	NDP510B NDP510BE NDB510B			0.15	Ω
			NDB510BE			0.3	Ω
$I_{D(on)}$	On-State Drain Current	$V_{GS} = 10\text{ V}$, $V_{DS} = 10\text{ V}$	NDP510A NDP510AE NDB510A NDB510AE	15			A
			NDP510B NDP510BE NDB510B NDB510BE	13			A
g_{FS}	Forward Transconductance	$V_{DS} = 10\text{ V}$, $I_D = 7.5\text{ A}$	ALL	6	8.6		S
DYNAMIC CHARACTERISTICS							
C_{iss}	Input Capacitance	$V_{DS} = 25\text{ V}$, $V_{GS} = 0\text{ V}$, $f = 1.0\text{ MHz}$	ALL		740	900	pF
C_{oss}	Output Capacitance		ALL		160	180	pF
C_{rss}	Reverse Transfer Capacitance		ALL		40	50	pF

Electrical Characteristics (T_c = 25°C unless otherwise noted)

Symbol	Parameter	Conditions	Type	Min	Typ	Max	Units
SWITCHING CHARACTERISTICS (Note 2)							
t _{D(ON)}	Turn - On Delay Time	V _{DD} = 50 V, I _D = 15 A, V _{GS} = 10 V, R _{GEN} = 24 Ω	ALL		10	20	nS
t _r	Turn - On Rise Time		ALL		63	100	nS
t _{D(OFF)}	Turn - Off Delay Time		ALL		49	80	nS
t _f	Turn - Off Fall Time		ALL		45	75	nS
Q _g	Total Gate Charge	V _{DS} = 80 V, I _D = 15 A, V _{GS} = 10V	ALL		22.5	30	nC
Q _{gs}	Gate-Source Charge		ALL		4.5		nC
Q _{gd}	Gate-Drain Charge		ALL		10.5		nC
DRAIN-SOURCE DIODE CHARACTERISTICS							
I _S	Maximum Continuous Drain-Source Diode Forward Current		NDP510A NDP510AE NDB510A NDB510AE			15	A
			NDP510B NDP510BE NDB510B NDB510BE			13	A
I _{SM}	Maximum Pulsed Drain-Source Diode Forward Current		NDP510A NDP510AE NDB510A NDB510AE			60	A
			NDP510B NDP510BE NDB510B NDB510BE			52	A
V _{SD} (Note 2)	Drain-Source Diode Forward Voltage	V _{GS} = 0 V, I _S = 7.5 A	T _J = 125°C	ALL	0.89	1.3	V
					0.85	1.2	V
t _{rr}	Reverse Recovery Time	V _{GS} = 0 V, I _S = 15 A, di _S /dt = 100 A/μs	ALL		98	140	ns
I _{rr}	Reverse Recovery Current		ALL		6.8	10	A
THERMAL CHARACTERISTICS							
R _{θJC}	Thermal Resistance, Junction-to-Case		ALL			2	°C/W
R _{θJA}	Thermal Resistance, Junction-to-Ambient		ALL			62.5	°C/W

Notes:

1. NDP510A/510B and NDB510A/510B are not rated for operation in avalanche mode.
2. Pulse Test: Pulse Width ≤ 300 μs, Duty Cycle ≤ 2.0%.

Typical Electrical Characteristics

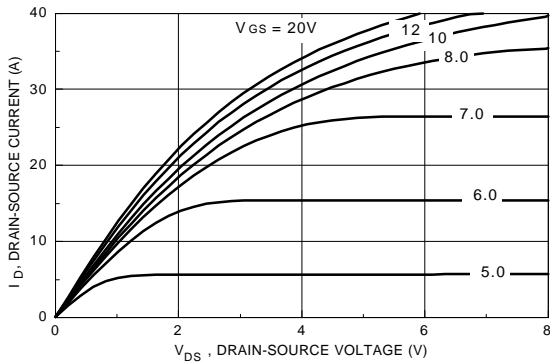

Figure 1. On-Region Characteristics.

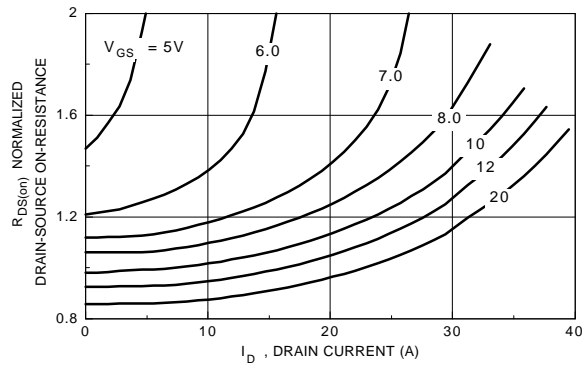

Figure 2. On-Resistance Variation with Gate Voltage and Drain Current.

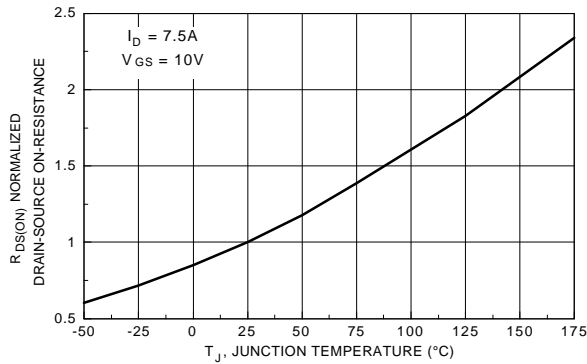

Figure 3. On-Resistance Variation with Temperature.

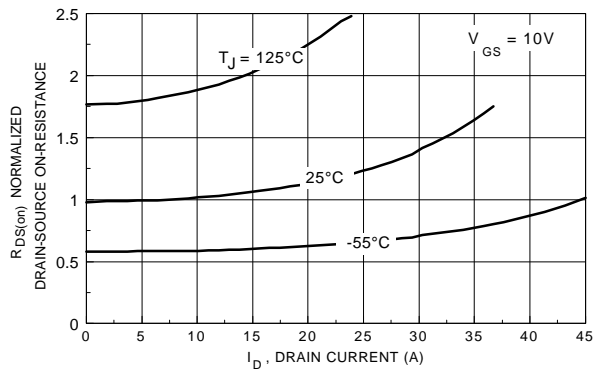

Figure 4. On-Resistance Variation with Drain Current and Temperature.

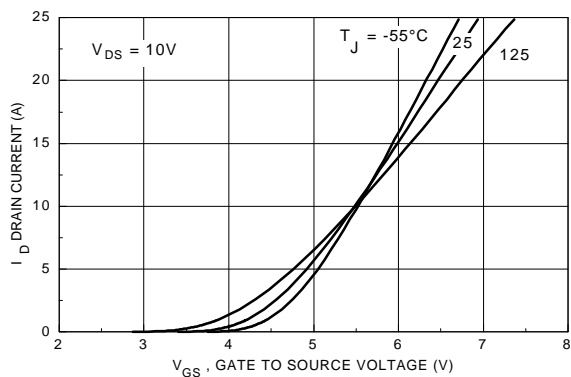

Figure 5. Transfer Characteristics.

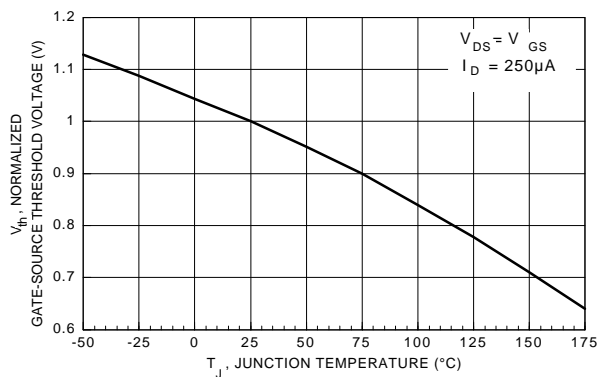

Figure 6. Gate Threshold Variation with Temperature.

Typical Electrical Characteristics (continued)

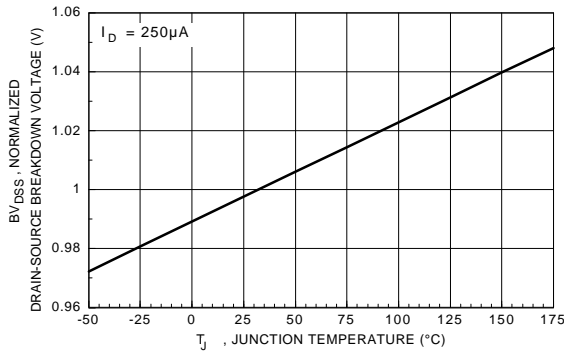

Figure 7. Breakdown Voltage Variation with Temperature.

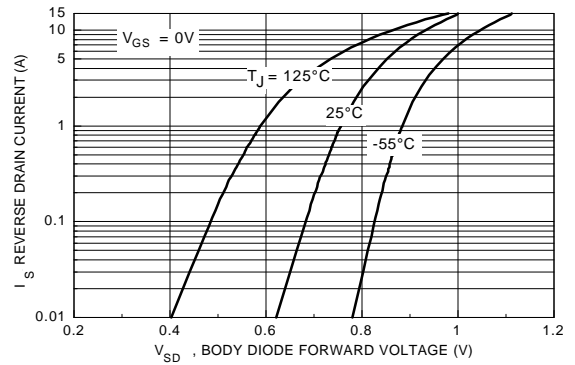

Figure 8. Body Diode Forward Voltage Variation with Current and Temperature.

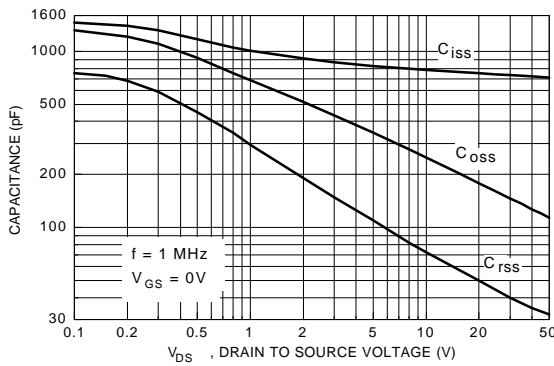

Figure 9. Capacitance Characteristics.

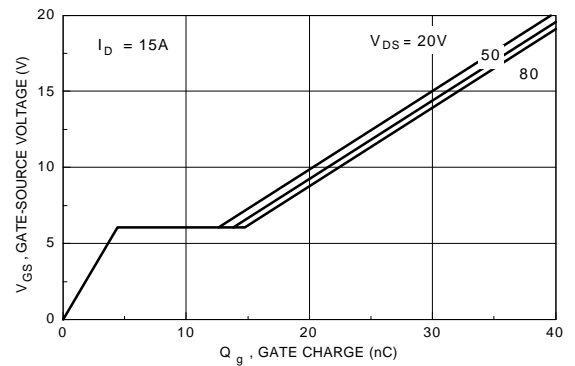

Figure 10. Gate Charge Characteristics.

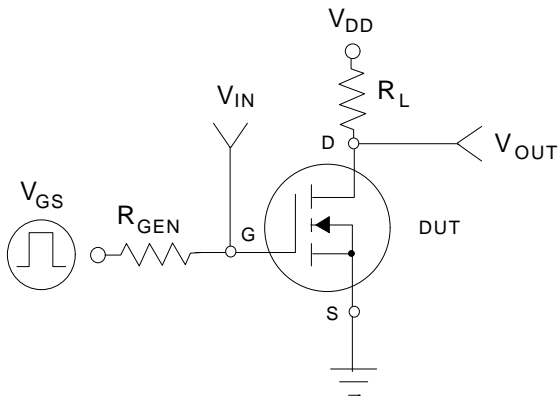

Figure 11. Switching Test Circuit.

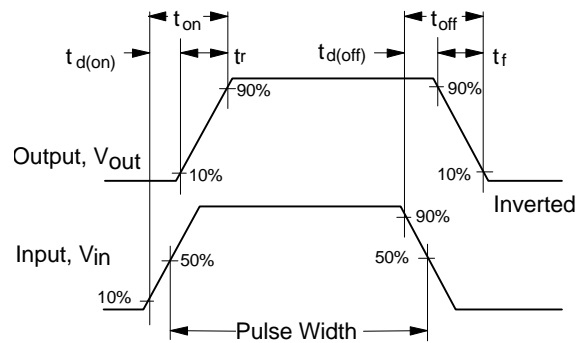

Figure 12. Switching Waveforms.

Typical Electrical Characteristics (continued)

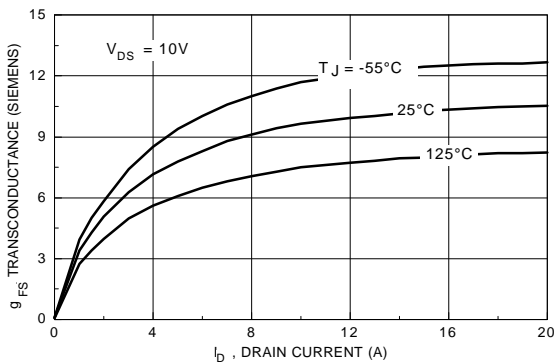

Figure 13. Transconductance Variation with Drain Current and Temperature.

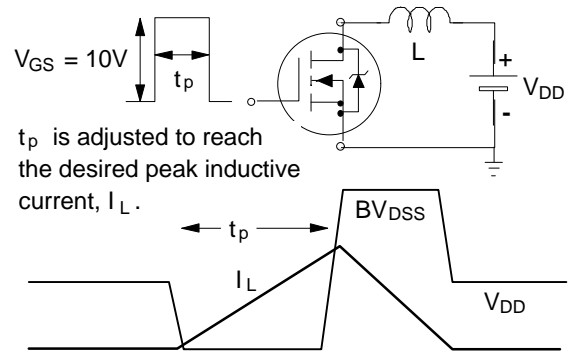

Figure 14. Unclamped Inductive Load Circuit and Waveforms.

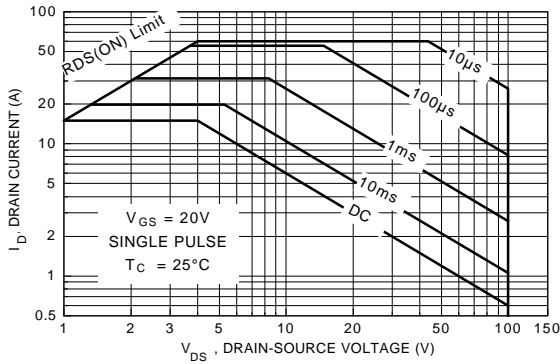

Figure 15. Maximum Safe Operating Area.

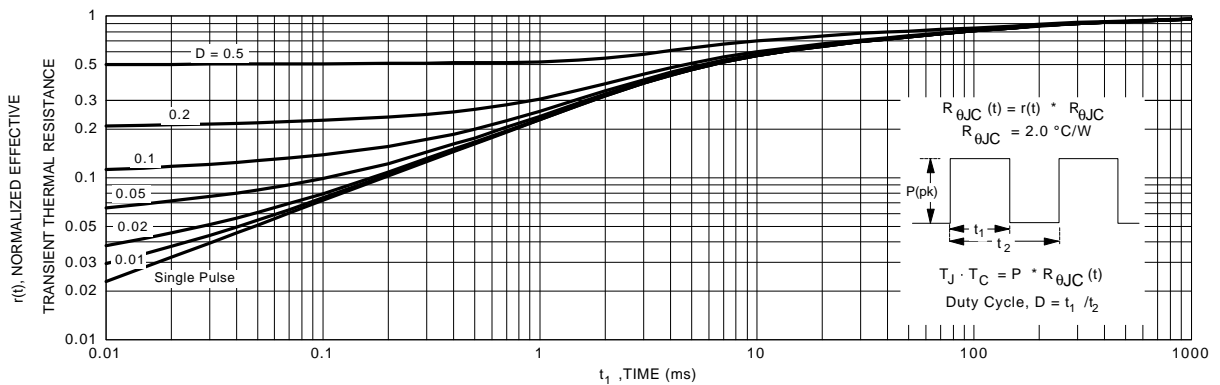

Figure 16. Transient Thermal Response Curve.