

NDP608A / NDP608AE / NDP608B / NDP608BE
NDB608A / NDB608AE / NDB608B / NDB608BE
N-Channel Enhancement Mode Field Effect Transistor

General Description

These N-channel enhancement mode power field effect transistors are produced using Fairchild's proprietary, high cell density, DMOS technology. This very high density process has been especially tailored to minimize on-state resistance, provide superior switching performance, and withstand high energy pulses in the avalanche and commutation modes. These devices are particularly suited for low voltage applications such as automotive, DC/DC converters, PWM motor controls, and other battery powered circuits where fast switching, low in-line power loss, and resistance to transients are needed.

Features

- 36 and 32A, 80V. $R_{DS(ON)} = 0.042$ and 0.045Ω .
- Critical DC electrical parameters specified at elevated temperature.
- Rugged internal source-drain diode can eliminate the need for an external Zener diode transient suppressor.
- 175°C maximum junction temperature rating.
- High density cell design (3 million/in²) for extremely low $R_{DS(ON)}$.
- TO-220 and TO-263 (D²PAK) package for both through hole and surface mount applications.

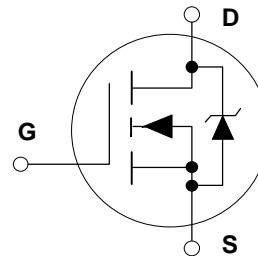
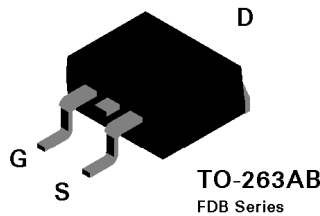
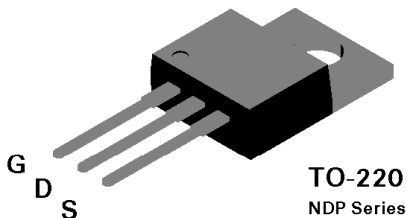

Absolute Maximum Ratings

$T_c = 25^\circ\text{C}$ unless otherwise noted

Symbol	Parameter	NDP608A	NDP608AE	NDP608B	NDP608BE	Units
		NDB608A	NDB608AE	NDB608B	NDB608BE	
V_{DSS}	Drain-Source Voltage	80				V
V_{DGR}	Drain-Gate Voltage ($R_{GS} \leq 1\text{ M}\Omega$)	80				V
V_{GSS}	Gate-Source Voltage - Continuous	± 20				V
	- Nonrepetitive ($t_p < 50\ \mu\text{s}$)	± 40				V
I_D	Drain Current - Continuous	36		32		A
	- Pulsed	144		128		A
P_D	Total Power Dissipation @ $T_c = 25^\circ\text{C}$	100				W
	Derate above 25°C	0.67				W/ $^\circ\text{C}$
T_J, T_{STG}	Operating and Storage Temperature Range	-65 to 175				$^\circ\text{C}$
T_L	Maximum lead temperature for soldering purposes, 1/8" from case for 5 seconds	275				$^\circ\text{C}$

Electrical Characteristics ($T_c = 25^\circ\text{C}$ unless otherwise noted)

Symbol	Parameter	Conditions	Type	Min	Typ	Max	Units
DRAIN-SOURCE AVALANCHE RATINGS (Note 1)							
E_{AS}	Single Pulse Drain-Source Avalanche Energy	$V_{DD} = 25\text{ V}$, $I_D = 36\text{ A}$	NDP608AE NDP608BE NDB608AE NDB608BE			200	mJ
I_{AR}	Maximum Drain-Source Avalanche Current					36	A
OFF CHARACTERISTICS							
BV_{DSS}	Drain-Source Breakdown Voltage	$V_{GS} = 0\text{ V}$, $I_D = 250\ \mu\text{A}$	ALL	80			V
I_{DSS}	Zero Gate Voltage Drain Current	$V_{DS} = 80\text{ V}$, $V_{GS} = 0\text{ V}$	ALL			250	μA
		$T_J = 125^\circ\text{C}$				1	mA
I_{GSSF}	Gate - Body Leakage, Forward	$V_{GS} = 20\text{ V}$, $V_{DS} = 0\text{ V}$	ALL			100	nA
I_{GSSR}	Gate - Body Leakage, Reverse	$V_{GS} = -20\text{ V}$, $V_{DS} = 0\text{ V}$	ALL			-100	nA
ON CHARACTERISTICS (Note 2)							
$V_{GS(th)}$	Gate Threshold Voltage	$V_{DS} = V_{GS}$, $I_D = 250\ \mu\text{A}$	ALL	2	2.9	4	V
		$T_J = 125^\circ\text{C}$		1.4	2.3	3.2	V
$R_{DS(on)}$	Static Drain-Source On-Resistance	$V_{GS} = 10\text{ V}$, $I_D = 18\text{ A}$	NDP608A NDP608AE NDB608A NDB608AE		0.031	0.042	Ω
		$T_J = 125^\circ\text{C}$	NDB608AE		0.05	0.08	Ω
		$V_{GS} = 10\text{ V}$, $I_D = 16\text{ A}$	NDP608B NDP608BE NDB608B NDB608BE			0.045	Ω
		$T_J = 125^\circ\text{C}$	NDB608BE			0.09	Ω
$I_{D(on)}$	On-State Drain Current	$V_{GS} = 10\text{ V}$, $V_{DS} = 10\text{ V}$	NDP608A NDP608AE NDB608A NDB608AE	36			A
			NDP608B NDP608BE NDB608B NDB608BE	32			A
g_{FS}	Forward Transconductance	$V_{DS} = 10\text{ V}$, $I_D = 18\text{ A}$	ALL	10	17.5		S
DYNAMIC CHARACTERISTICS							
C_{iss}	Input Capacitance	$V_{DS} = 25\text{ V}$, $V_{GS} = 0\text{ V}$, $f = 1.0\text{ MHz}$	ALL		1370	1800	pF
C_{oss}	Output Capacitance		ALL		390	500	pF
C_{rss}	Reverse Transfer Capacitance		ALL		140	200	pF

Electrical Characteristics (T_c = 25°C unless otherwise noted)

Symbol	Parameter	Conditions	Type	Min	Typ	Max	Units	
SWITCHING CHARACTERISTICS (Note 2)								
t _{D(ON)}	Turn - On Delay Time	V _{DD} = 40 V, I _D = 36 A, V _{GS} = 10 V, R _{GEN} = 7.5 Ω	ALL		11	20	nS	
t _r	Turn - On Rise Time		ALL		113	190	nS	
t _{D(OFF)}	Turn - Off Delay Time		ALL		37	60	nS	
t _f	Turn - Off Fall Time		ALL		69	110	nS	
Q _g	Total Gate Charge	V _{DS} = 64 V, I _D = 36 A, V _{GS} = 10V	ALL		46	65	nC	
Q _{gs}	Gate-Source Charge		ALL		8		nC	
Q _{gd}	Gate-Drain Charge		ALL		25		nC	
DRAIN-SOURCE DIODE CHARACTERISTICS								
I _S	Maximum Continuous Drain-Source Diode Forward Current		NDP608A NDP608AE NDB608A NDB608AE			36	A	
			NDP608B NDP608BE NDB608B NDB608BE			32	A	
I _{SM}	Maximum Pulsed Drain-Source Diode Forward Current		NDP608A NDP608AE NDB608A NDB608AE			144	A	
			NDP608B NDP608BE NDB608B NDB608BE			128	A	
V _{SD} (Note 2)	Drain-Source Diode Forward Voltage	V _{GS} = 0 V, I _S = 18 A	ALL	T _J = 125°C		0.91	1.3	V
						0.81	1.2	V
t _{rr}	Reverse Recovery Time	V _{GS} = 0 V, I _S = 36 A, di _s /dt = 100 A/μs	ALL		88	125	ns	
I _{rr}	Reverse Recovery Current		ALL		6	9	A	
THERMAL CHARACTERISTICS								
R _{θJC}	Thermal Resistance, Junction-to-Case		ALL			1.5	°C/W	
R _{θJA}	Thermal Resistance, Junction-to-Ambient		ALL			62.5	°C/W	

Notes:

1. NDP608A/608B and NDB608A/608B are not rated for operation in avalanche mode.
2. Pulse Test: Pulse Width ≤ 300 μs, Duty Cycle ≤ 2.0%.

Typical Electrical Characteristics

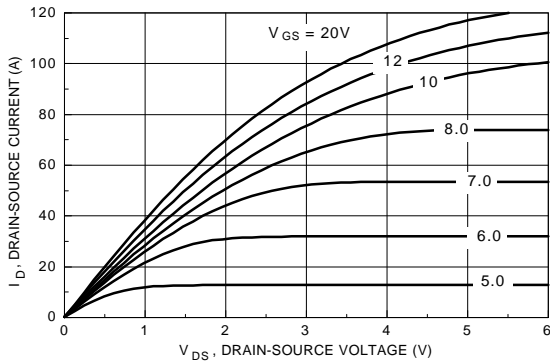

Figure 1. On-Region Characteristics.

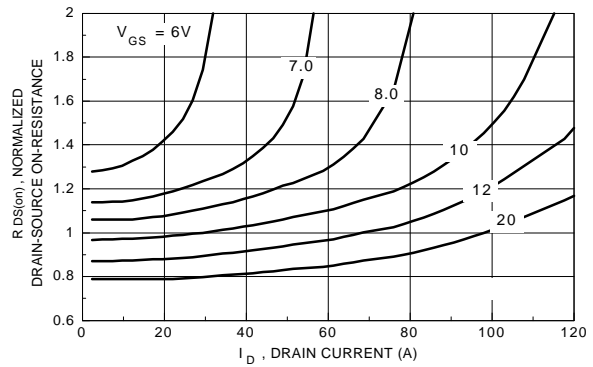

Figure 2. On-Resistance Variation with Gate Voltage and Drain Current.

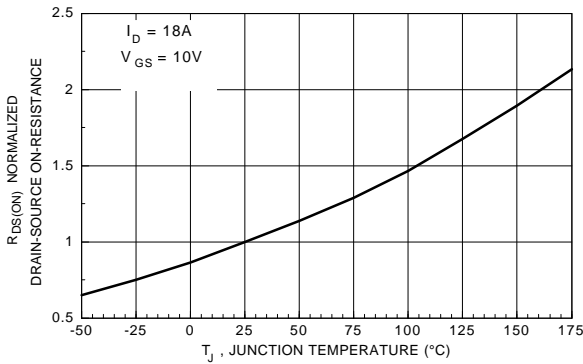

Figure 3. On-Resistance Variation with Temperature.

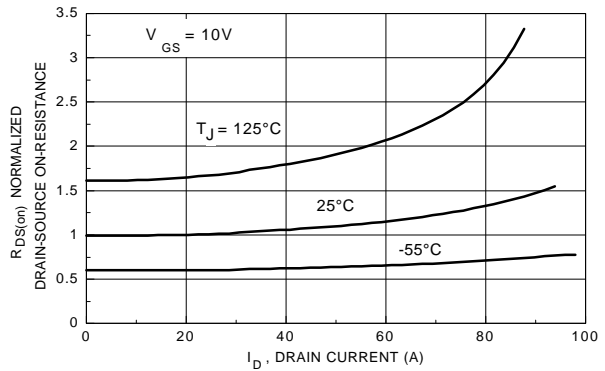

Figure 4. On-Resistance Variation with Drain Current and Temperature.

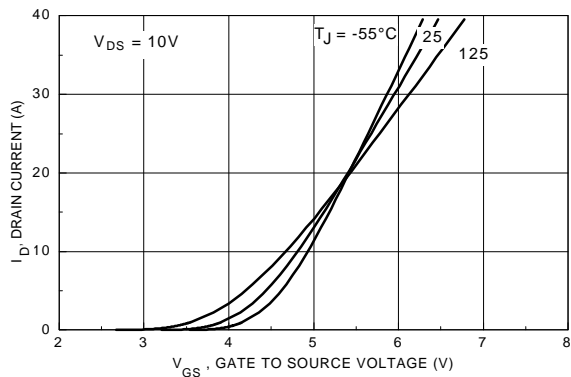

Figure 5. Transfer Characteristics.

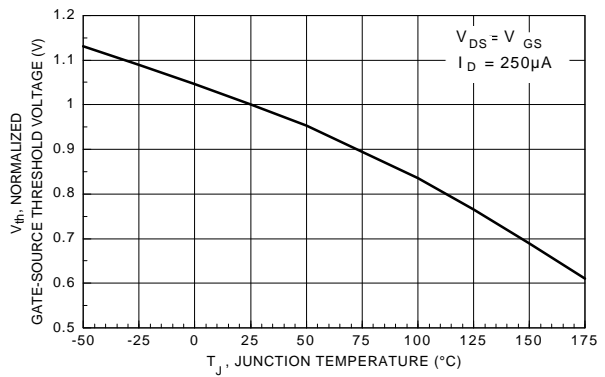

Figure 6. Gate Threshold Variation with Temperature.

Typical Electrical Characteristics (continued)

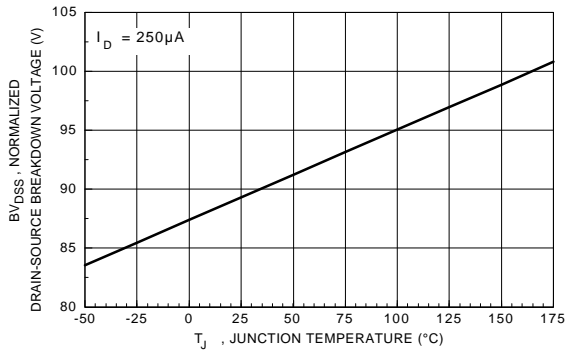

Figure 7. Breakdown Voltage Variation with Temperature.

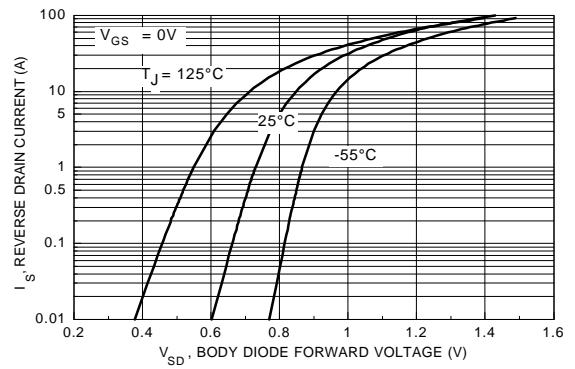

Figure 8. Body Diode Forward Voltage Variation with Current and Temperature.

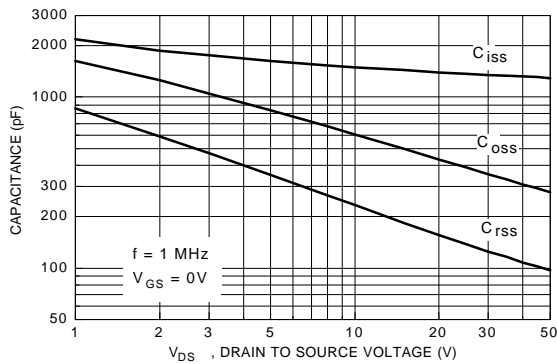

Figure 9. Capacitance Characteristics.

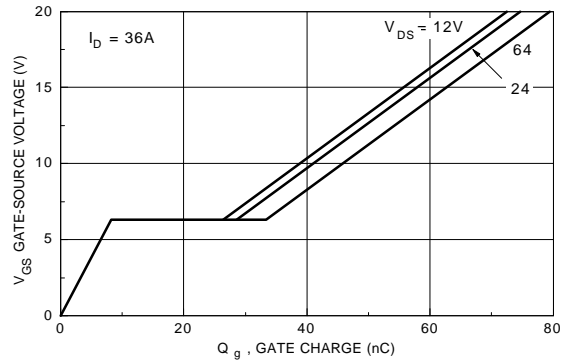

Figure 10. Gate Charge Characteristics.

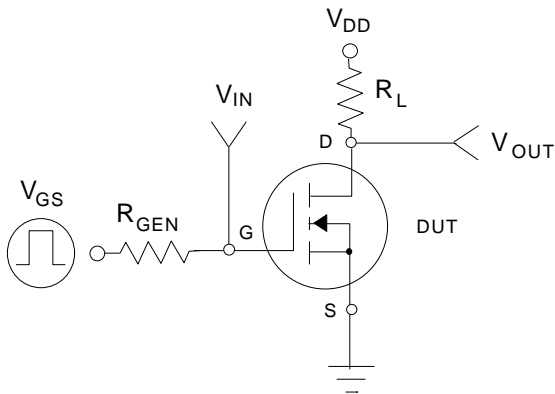

Figure 36. Switching Test Circuit.

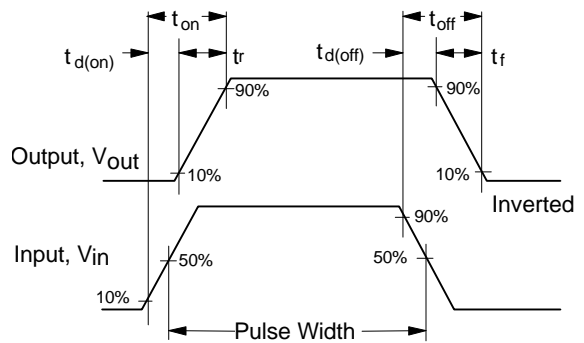

Figure 12. Switching Waveforms.

Typical Electrical Characteristics (continued)

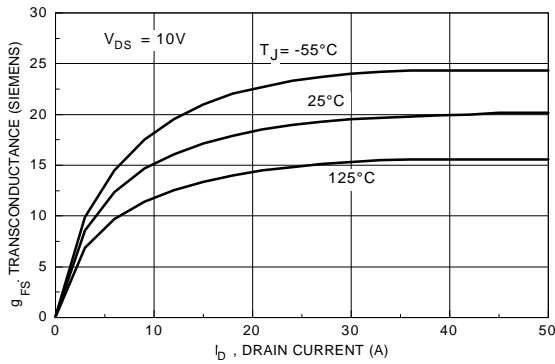

Figure 13. Transconductance Variation with Drain Current and Temperature.

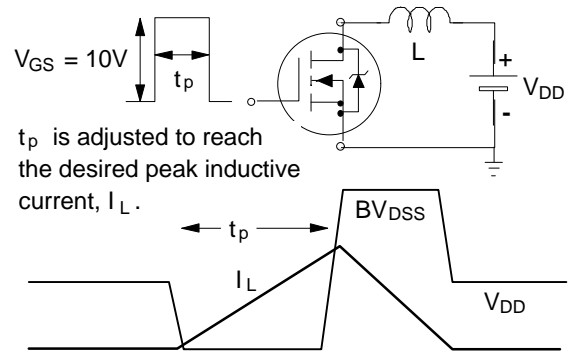

Figure 14. Unclamped Inductive Load Circuit and Waveforms.

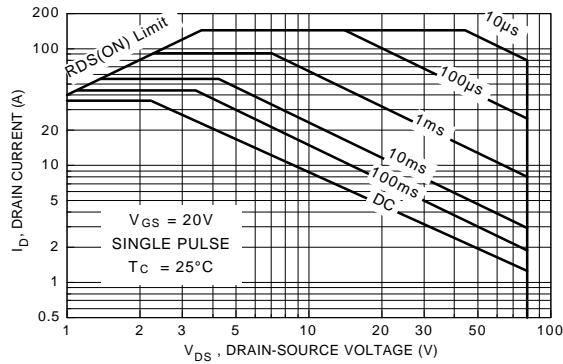

Figure 15. Maximum Safe Operating Area.

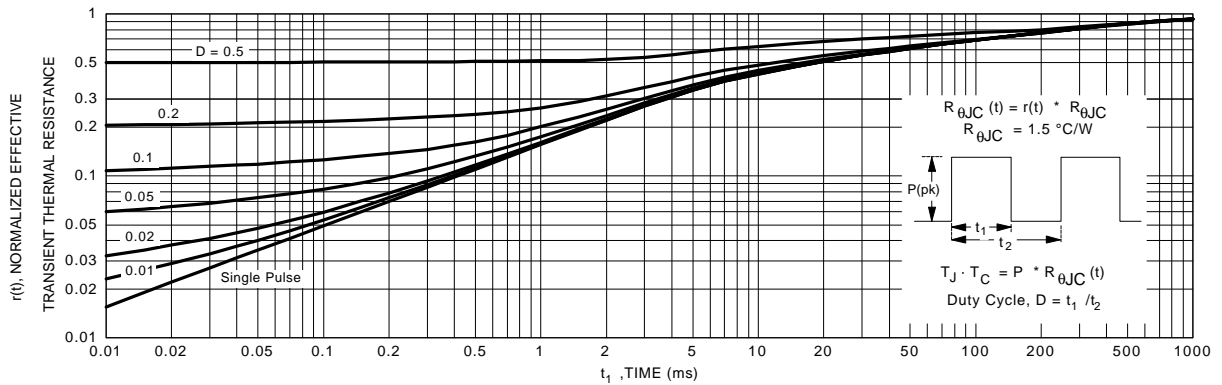

Figure 16. Transient Thermal Response Curve.