

NDP710A / NDP710AE / NDP710B / NDP710BE NDB710A / NDB710AE / NDB710B / NDB710BE N-Channel Enhancement Mode Field Effect Transistor

General Description

These N-channel enhancement mode power field effect transistors are produced using Fairchild's proprietary, high cell density, DMOS technology. This very high density process has been especially tailored to minimize on-state resistance, provide superior switching performance, and withstand high energy pulses in the avalanche and commutation modes. These devices are particularly suited for low voltage applications such as automotive, DC/DC converters, PWM motor controls, and other battery powered circuits where fast switching, low in-line power loss, and resistance to transients are needed.

Features

- 42 and 40A, 100V. $R_{DS(ON)} = 0.038$ and 0.042Ω .
- Critical DC electrical parameters specified at elevated temperature.
- Rugged internal source-drain diode can eliminate the need for an external Zener diode transient suppressor.
- 175°C maximum junction temperature rating.
- High density cell design (3 million/in²) for extremely low $R_{DS(ON)}$.
- TO-220 and TO-263 (D²PAK) package for both through hole and surface mount applications.

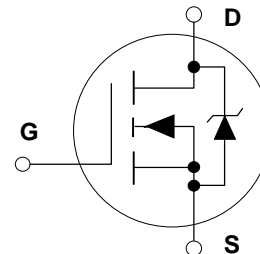
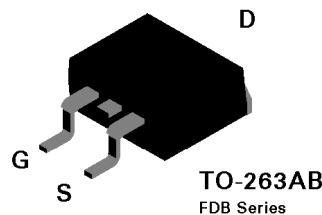
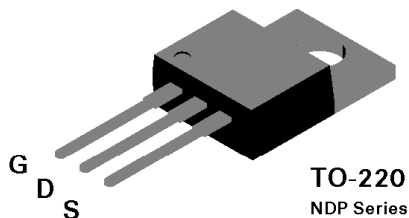

Absolute Maximum Ratings

$T_c = 25^\circ\text{C}$ unless otherwise noted

Symbol	Parameter	NDP710A NDB710A	NDP710AE NDB710AE	NDP710B NDB710B	NDP710BE NDB710BE	Units
V_{DSS}	Drain-Source Voltage	100		100		V
V_{DGR}	Drain-Gate Voltage ($R_{GS} \leq 1\text{ M}\Omega$)	100		100		V
V_{GSS}	Gate-Source Voltage - Continuous	± 20		± 20		V
	- Nonrepetitive ($t_p < 50\ \mu\text{s}$)	± 40		± 40		V
I_D	Drain Current - Continuous	42	40	40	40	A
	- Pulsed	168	160	160	160	A
P_D	Total Power Dissipation @ $T_c = 25^\circ\text{C}$	150		150		W
	Derate above 25°C	1		1		W/ $^\circ\text{C}$
T_J, T_{STG}	Operating and Storage Temperature Range	-65 to 175		-65 to 175		$^\circ\text{C}$
T_L	Maximum lead temperature for soldering purposes, 1/8" from case for 5 seconds	275		275		$^\circ\text{C}$

Electrical Characteristics ($T_c = 25^\circ\text{C}$ unless otherwise noted)

Symbol	Parameter	Conditions	Type	Min	Typ	Max	Units
DRAIN-SOURCE AVALANCHE RATINGS (Note 1)							
E_{AS}	Single Pulse Drain-Source Avalanche Energy	$V_{DD} = 25\text{ V}, I_D = 42\text{ A}$	NDP710AE NDP710BE			700	mJ
I_{AR}	Maximum Drain-Source Avalanche Current		NDB710AE NDB710BE			42	A
OFF CHARACTERISTICS							
BV_{DSS}	Drain-Source Breakdown Voltage	$V_{GS} = 0\text{ V}, I_D = 250\ \mu\text{A}$	ALL	100			V
I_{DSS}	Zero Gate Voltage Drain Current	$V_{DS} = 100\text{ V},$ $V_{GS} = 0\text{ V}$ $T_J = 125^\circ\text{C}$	ALL			250	μA
						1	mA
I_{GSSF}	Gate - Body Leakage, Forward	$V_{GS} = 20\text{ V}, V_{DS} = 0\text{ V}$	ALL			100	nA
I_{GSSR}	Gate - Body Leakage, Reverse	$V_{GS} = -20\text{ V}, V_{DS} = 0\text{ V}$	ALL			-100	nA
ON CHARACTERISTICS (Note 2)							
$V_{GS(th)}$	Gate Threshold Voltage	$V_{DS} = V_{GS},$ $I_D = 250\ \mu\text{A}$ $T_J = 125^\circ\text{C}$	ALL	2	2.9	4	V
				1.4	2.2	3.6	V
$R_{DS(on)}$	Static Drain-Source On-Resistance	$V_{GS} = 10\text{ V},$ $I_D = 21\text{ A}$ $T_J = 125^\circ\text{C}$	NDP710A NDP710AE NDB710A		0.026	0.038	Ω
			NDB710AE		0.044	0.08	Ω
		$V_{GS} = 10\text{ V},$ $I_D = 20\text{ A}$ $T_J = 125^\circ\text{C}$	NDP710B NDP710BE NDB710B			0.042	Ω
			NDB710BE			0.09	Ω
$I_{D(on)}$	On-State Drain Current	$V_{GS} = 10\text{ V}, V_{DS} = 10\text{ V}$	NDP710A NDP710AE NDB710A NDB710AE	42			A
			NDP710B NDP710BE NDB710B NDB710BE	40			A
g_{FS}	Forward Transconductance	$V_{DS} = 10\text{ V}, I_D = 21\text{ A}$	ALL	20	28		S
DYNAMIC CHARACTERISTICS							
C_{iss}	Input Capacitance	$V_{DS} = 25\text{ V}, V_{GS} = 0\text{ V},$ $f = 1.0\text{ MHz}$	ALL		2840	3600	pF
C_{oss}	Output Capacitance		ALL		550	700	pF
C_{rss}	Reverse Transfer Capacitance		ALL		175	200	pF

Electrical Characteristics (T_c = 25°C unless otherwise noted)

Symbol	Parameter	Conditions	Type	Min	Typ	Max	Units	
SWITCHING CHARACTERISTICS (Note 2)								
t _{D(ON)}	Turn - On Delay Time	V _{DD} = 50 V, I _D = 42 A, V _{GS} = 10 V, R _{GEN} = 5 Ω	ALL		15	25	nS	
t _r	Turn - On Rise Time		ALL		111	180	nS	
t _{D(OFF)}	Turn - Off Delay Time		ALL		55	90	nS	
t _f	Turn - Off Fall Time		ALL		81	130	nS	
Q _g	Total Gate Charge	V _{DS} = 80 V, I _D = 42 A, V _{GS} = 10V	ALL		92	130	nC	
Q _{gs}	Gate-Source Charge		ALL		15		nC	
Q _{gd}	Gate-Drain Charge		ALL		44		nC	
DRAIN-SOURCE DIODE CHARACTERISTICS								
I _S	Maximum Continuous Drain-Source Diode Forward Current		NDP710A NDP710AE NDB710A NDB710AE			42	A	
			NDP710B NDP710BE NDB710B NDB710BE			40	A	
I _{SM}	Maximum Pulsed Drain-Source Diode Forward Current		NDP710A NDP710AE NDB710A NDB710AE			168	A	
			NDP710B NDP710BE NDB710B NDB710BE			160	A	
V _{SD} (Note 2)	Drain-Source Diode Forward Voltage	V _{GS} = 0 V, I _S = 21 A		T _J = 125°C		0.89	1.3	V
						0.69	1.2	V
t _{rr}	Reverse Recovery Time	V _{GS} = 0 V, I _S = 42 A, di _S /dt = 100 A/μs	ALL		128	180	ns	
I _{rr}	Reverse Recovery Current		ALL		8.7	13	A	
THERMAL CHARACTERISTICS								
R _{θJC}	Thermal Resistance, Junction-to-Case		ALL			1	°C/W	
R _{θJA}	Thermal Resistance, Junction-to-Ambient		ALL			62.5	°C/W	

Notes:

1. NDP710A/710B and NDB710A/710B are not rated for operation in avalanche mode.
2. Pulse Test: Pulse Width ≤ 300 μs, Duty Cycle ≤ 2.0%.

Typical Electrical Characteristics

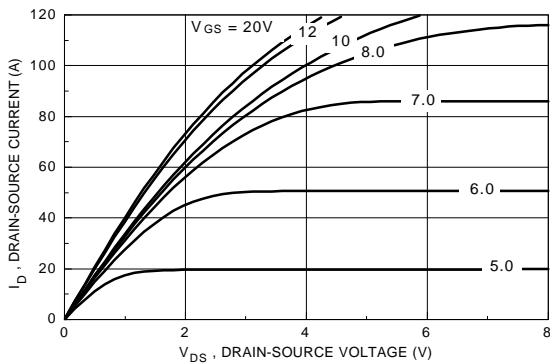

Figure 1. On-Region Characteristics.

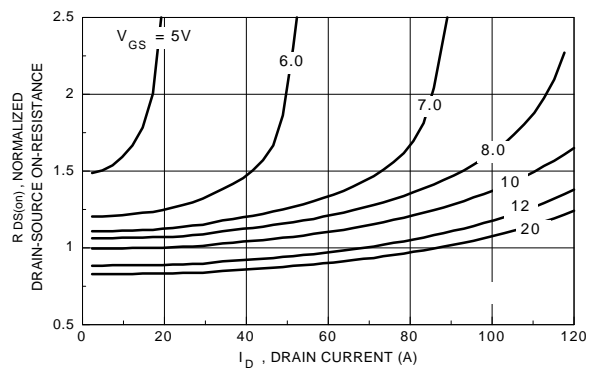

Figure 2. On-Resistance Variation with Gate Voltage and Drain Current.

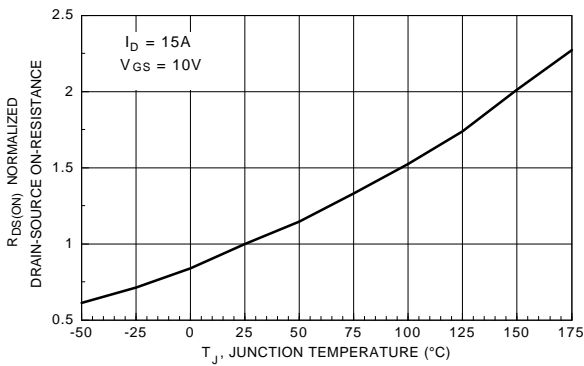

Figure 3. On-Resistance Variation with Temperature.

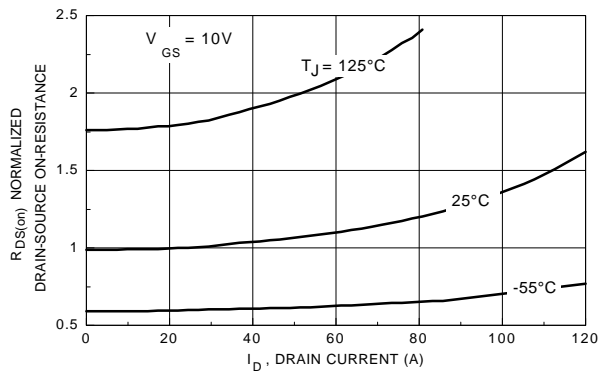

Figure 4. On-Resistance Variation with Drain Current and Temperature.

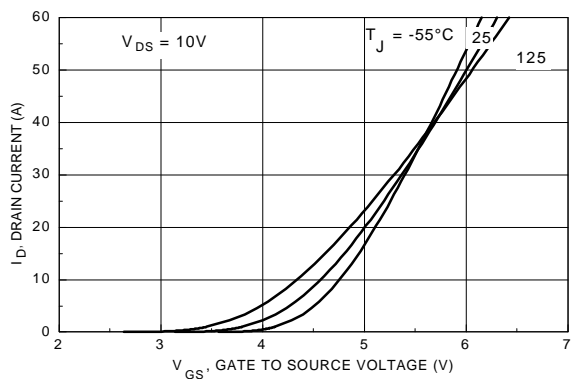

Figure 5. Transfer Characteristics.

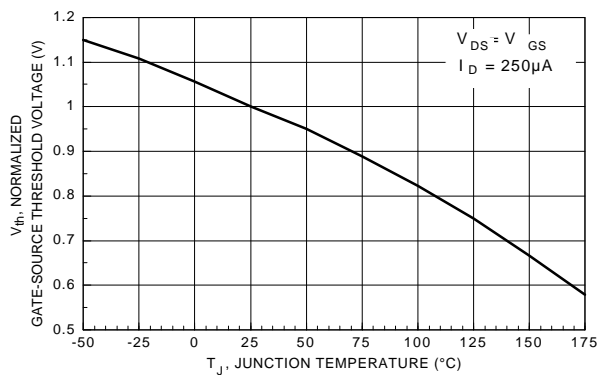

Figure 6. Gate Threshold Variation with Temperature.

Typical Electrical Characteristics (continued)

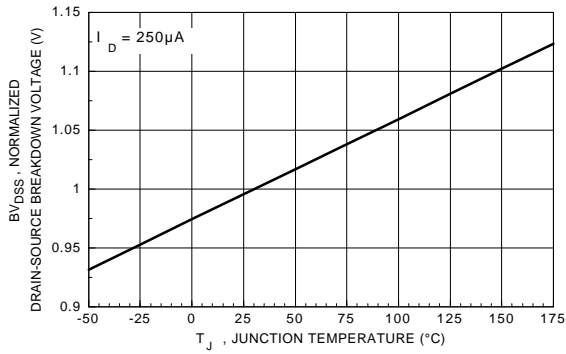

Figure 7. Breakdown Voltage Variation with Temperature.

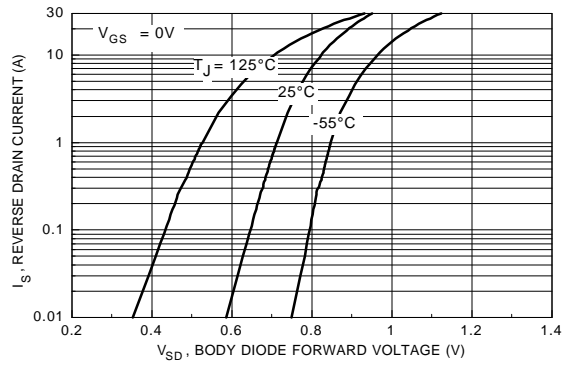

Figure 8. Body Diode Forward Voltage Variation with Current and Temperature.

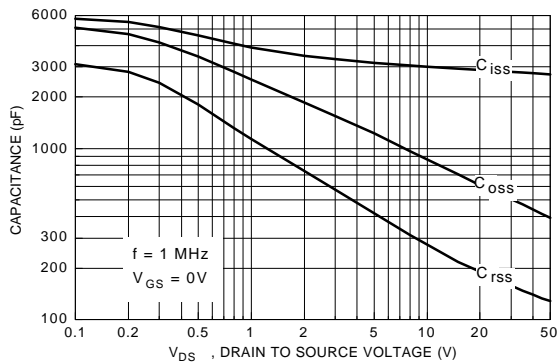

Figure 9. Capacitance Characteristics.

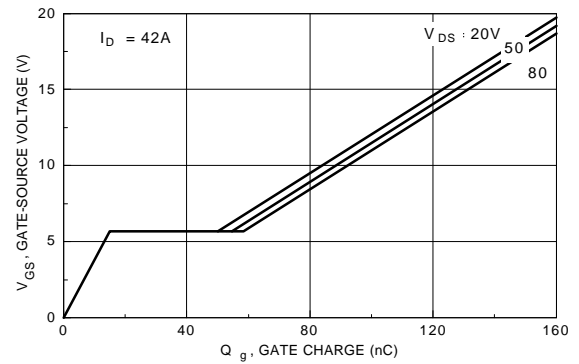

Figure 10. Gate Charge Characteristics.

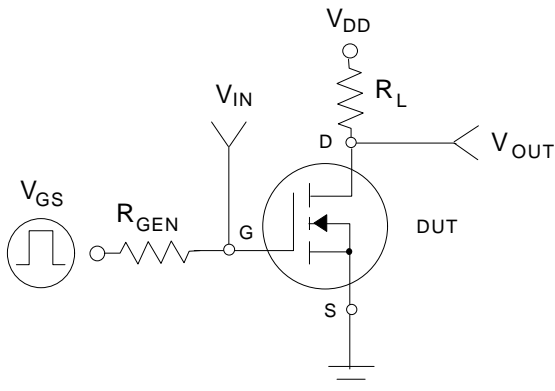

Figure 36. Switching Test Circuit.

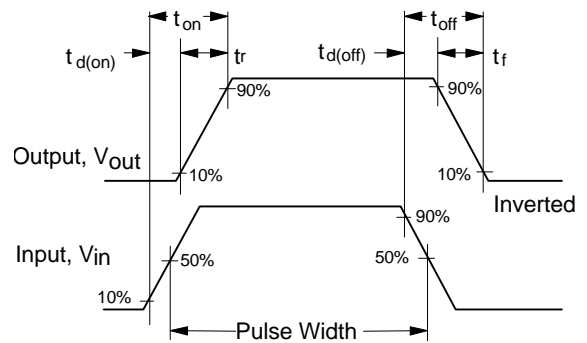

Figure 12. Switching Waveforms.

Typical Electrical Characteristics (continued)

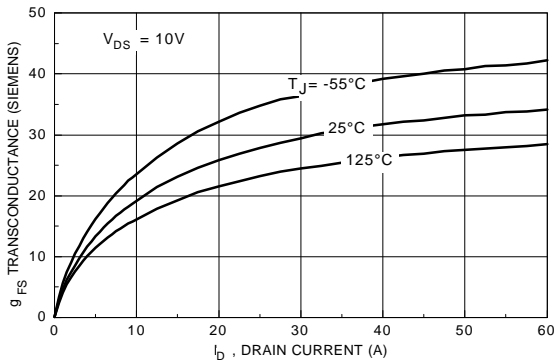

Figure 13. Transconductance Variation with Drain Current and Temperature.

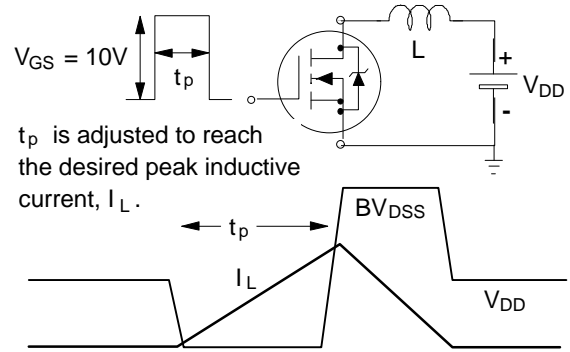

Figure 14. Unclamped Inductive Load Circuit and Waveforms.

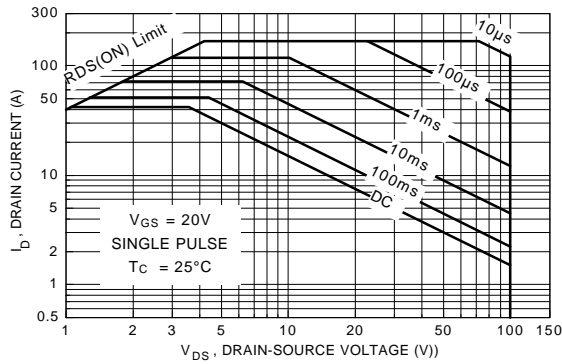

Figure 15. Maximum Safe Operating Area.

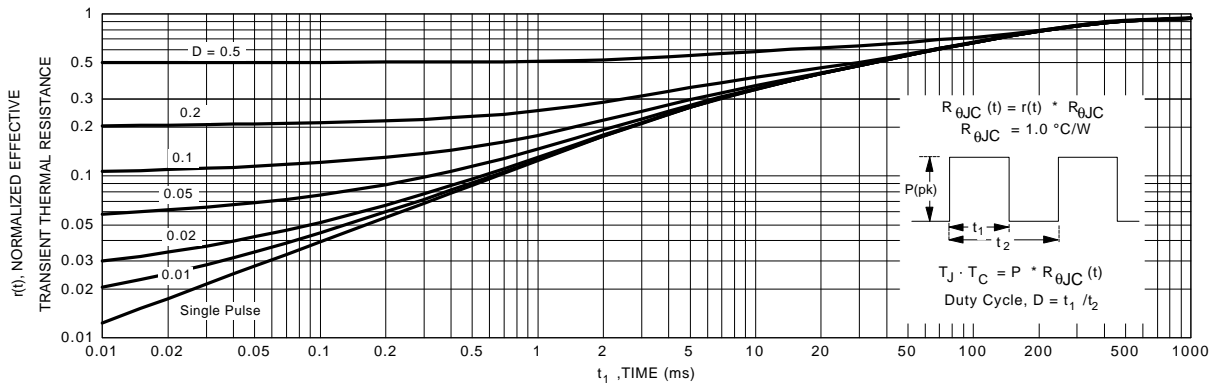

Figure 16. Transient Thermal Response Curve.