

NDPL070N10B

Power MOSFET 100V, 10.8mΩ, 70A, N-Channel

This N-Channel Power MOSFET is produced using ON Semiconductor's trench technology, which is specifically designed to minimize gate charge and ultra low on resistance. This device is suitable for applications with low gate charge driving or ultra low on resistance requirements.

Features

- Low On-Resistance
- Low Gate Charge
- High Speed Switching
- 100% Avalanche Tested
- Pb-Free and RoHS compliance

Applications

- Battery Protection
- Motor Drive
- Primary Side Switch
- Secondary Side Synchronous Rectification

SPECIFICATION

ABSOLUTE MAXIMUM RATINGS at Ta = 25°C (Note 1)

Parameter	Symbol	Value	Unit
Drain to Source Voltage	V _{DSS}	100	V
Gate to Source Voltage	V _{GSS}	±20	V
Drain Current (DC)	I _D	70	A
Drain Current (Pulse) PW≤10μs, duty cycle≤1%	I _{DP}	280	A
Power Dissipation T _C =25°C	P _D	2.1 72	W
Junction Temperature	T _j	175	°C
Storage Temperature	T _{stg}	-55 to +175	°C
Source Current (Body Diode)	I _S	70	A
Avalanche Energy (Single Pulse) (Note 2)	E _{AS}	82	mJ
Lead Temperature for Soldering Purposes, 3mm from Case for 10 Seconds	T _L	260	°C

Note 1 : Stresses exceeding those listed in the Maximum Ratings table may damage the device. If any of these limits are exceeded, device functionality should not be assumed, damage may occur and reliability may be affected.

2 : V_{DD}=48V, L=100μH, I_{AV}=30A (Fig.1)

Thermal Resistance Ratings

Parameter	Symbol	Value	Unit
Junction to Case Steady State	R _{θJC}	2.08	°C/W
Junction to Ambient (Note 3)	R _{θJA}	71.4	

Note 3 : Insertion mounted



ON Semiconductor®

www.onsemi.com

V _{DSS}	R _{DS(on)} Max	I _D Max
100V	10.8 mΩ@15V	70A
	12.8 mΩ@10V	

ELECTRICAL CONNECTION N-Channel

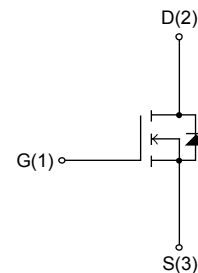

MARKING

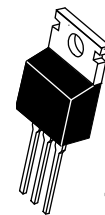

TO-220-3L

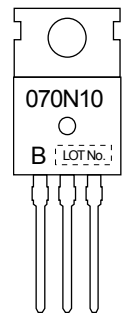

ORDERING INFORMATION

See detailed ordering and shipping information on page 6 of this data sheet.

NDPL070N10B

ELECTRICAL CHARACTERISTICS at Ta = 25°C (Note 4)

Parameter	Symbol	Conditions	Value			Unit
			min	typ	max	
Drain to Source Breakdown Voltage	V(BR)DSS	ID=10mA, VGS=0V	100			V
Zero-Gate Voltage Drain Current	IDSS	VDS=100V, VGS=0V			10	μA
Gate to Source Leakage Current	IGSS	VGS=±20V, VDS=0V			±100	nA
Gate Threshold Voltage	VGS(th)	VDS=10V, ID=1mA	2		4	V
Forward Transconductance	gFS	VDS=10V, ID=35A		50		S
Static Drain to Source On-State Resistance	RDS(on)1	ID=35A, VGS=15V		9.0	10.8	mΩ
	RDS(on)2	ID=35A, VGS=10V		9.8	12.8	mΩ
Input Capacitance	Ciss	VDS=50V, f=1MHz		2,010		pF
Output Capacitance	Coss			840		pF
Reverse Transfer Capacitance	Crss			21		pF
Turn-ON Delay Time	td(on)	See Fig.2		30		ns
Rise Time	tr			180		ns
Turn-OFF Delay Time	td(off)			55		ns
Fall Time	tf			40		ns
Total Gate Charge	Qg	VDS=48V, VGS=10V, ID=70A		26		nC
Gate to Source Charge	Qgs			9		nC
Gate to Drain "Miller" Charge	Qgd			8		nC
Forward Diode Voltage	VSD	IS=70A, VGS=0V		1.1	1.5	V
Reverse Recovery Time	trr	See Fig.3		95		ns
Reverse Recovery Charge	Qrr	IS=70A, VGS=0V, di/dt=100A/μs		240		nC

Note 4 : Product parametric performance is indicated in the Electrical Characteristics for the listed test conditions, unless otherwise noted. Product performance may not be indicated by the Electrical Characteristics if operated under different conditions.

Fig.1 Unclamped Inductive Switching Test Circuit

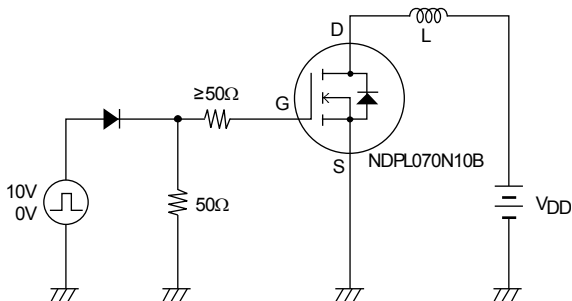

Fig.2 Switching Time Test Circuit

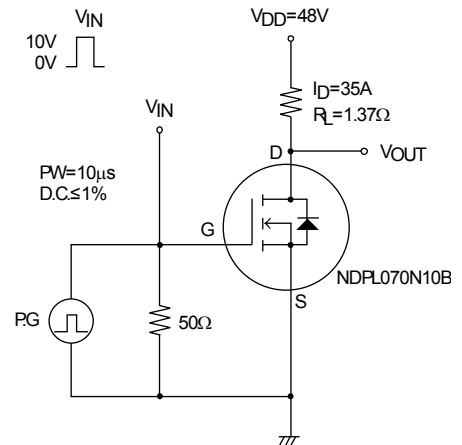
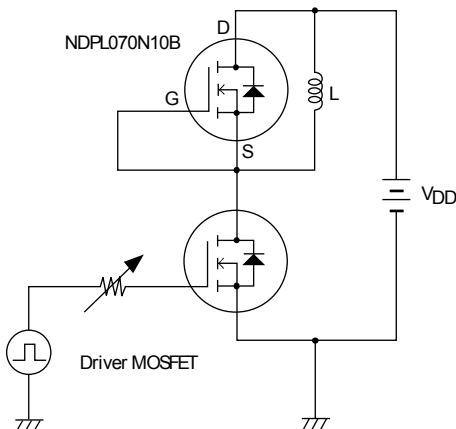
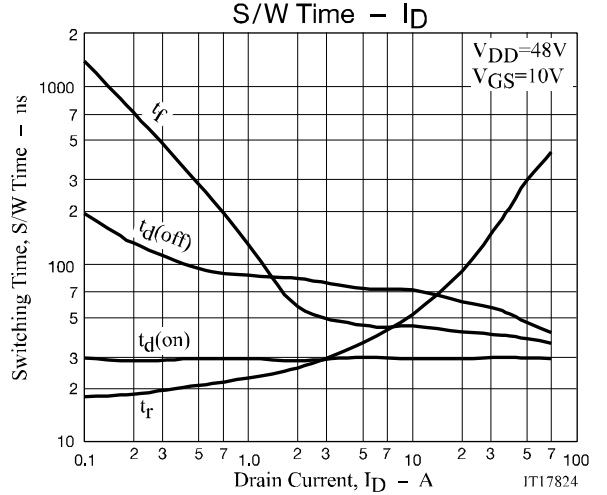
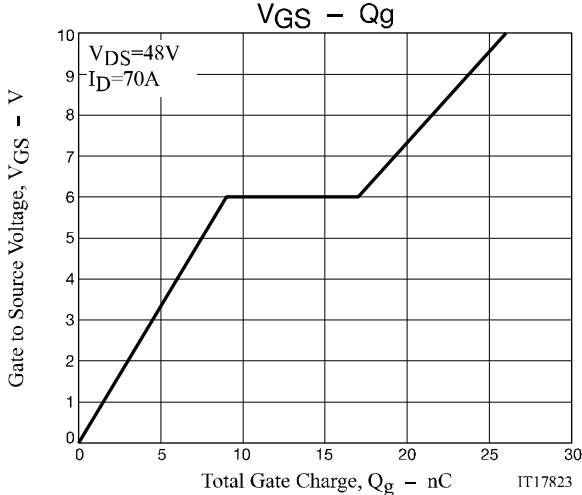
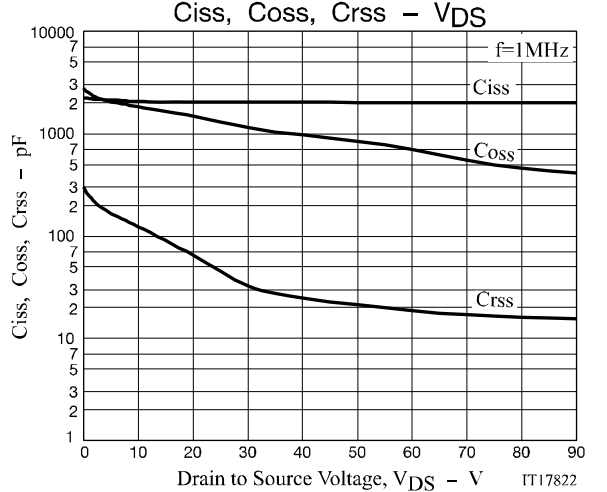
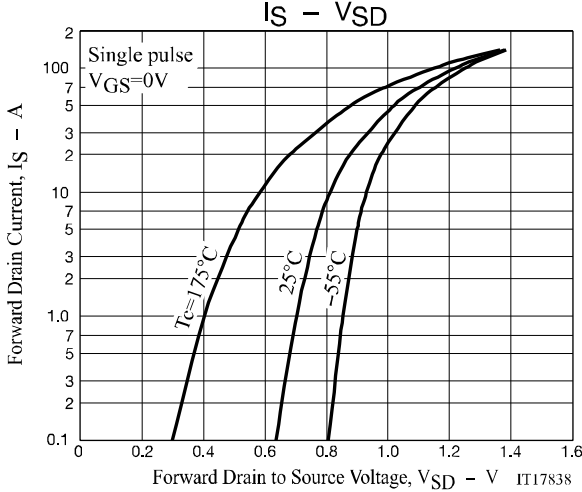
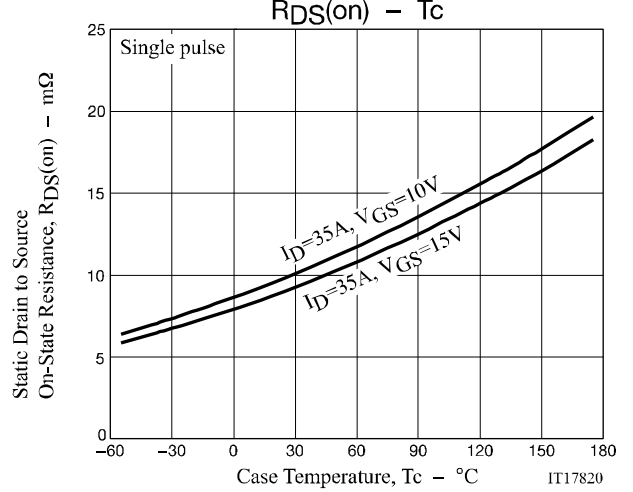
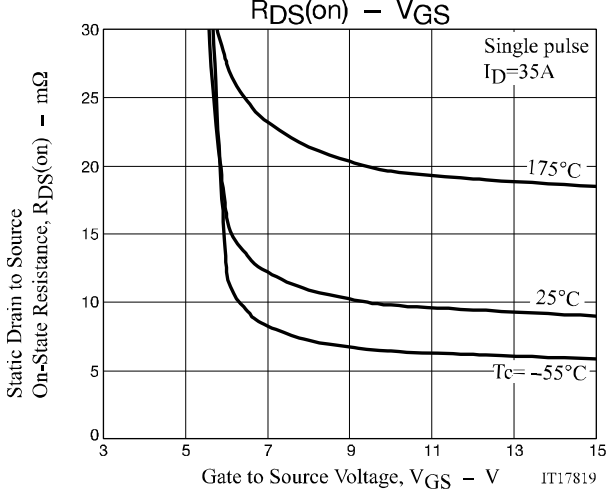
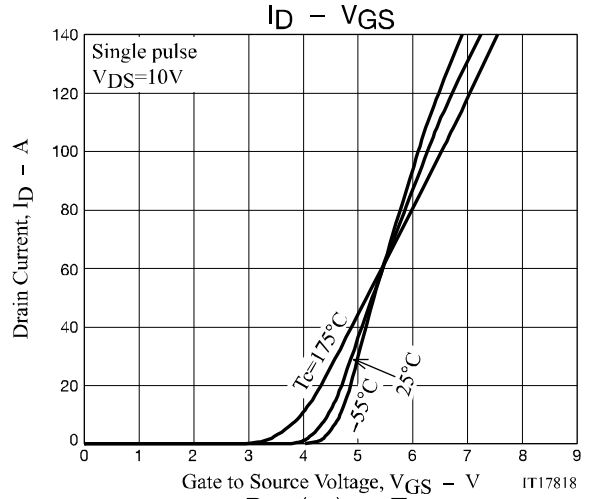
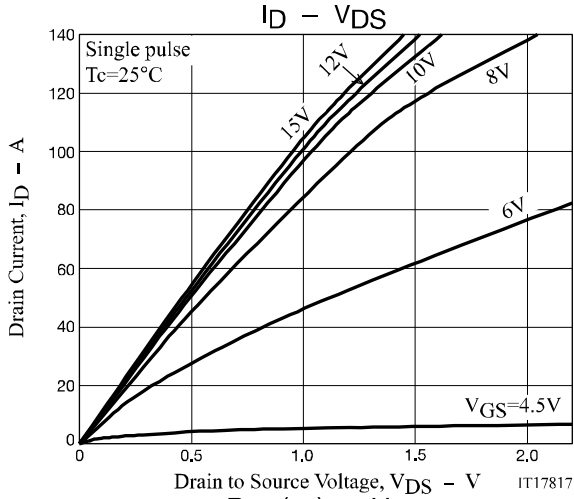

Fig.3 Reverse Recovery Time Test Circuit



NDPL070N10B



NDPL070N10B

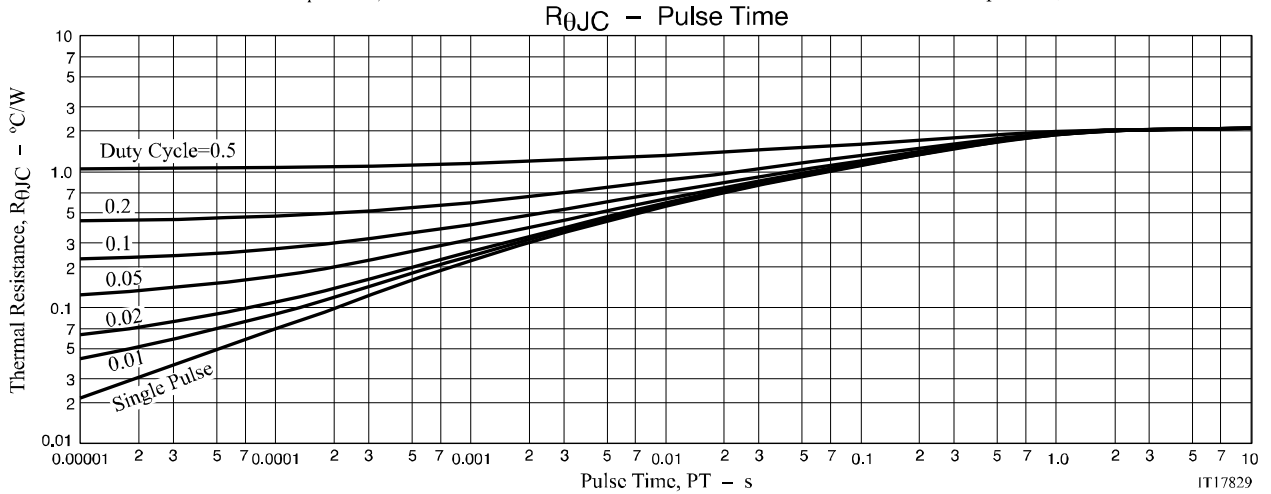
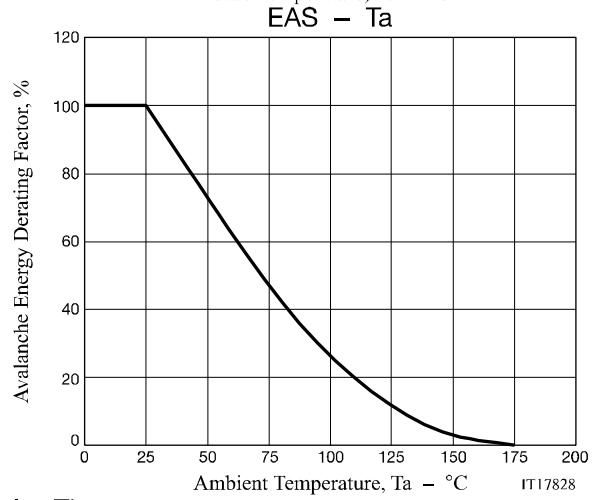
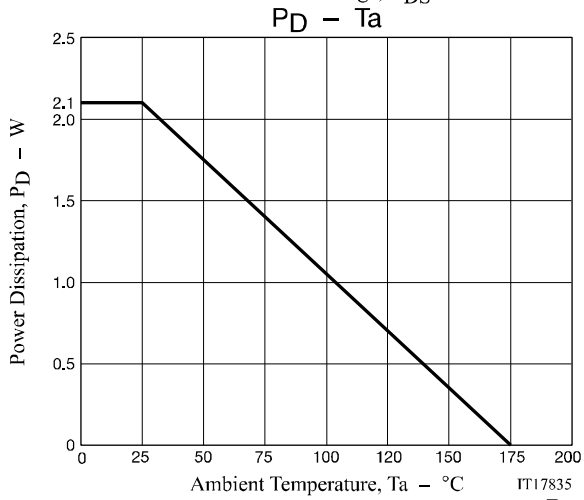
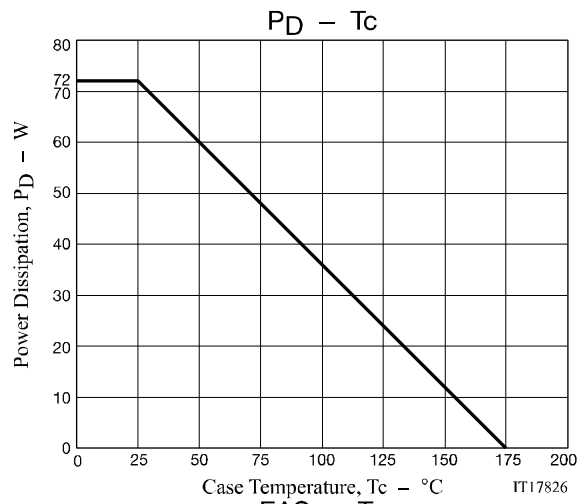
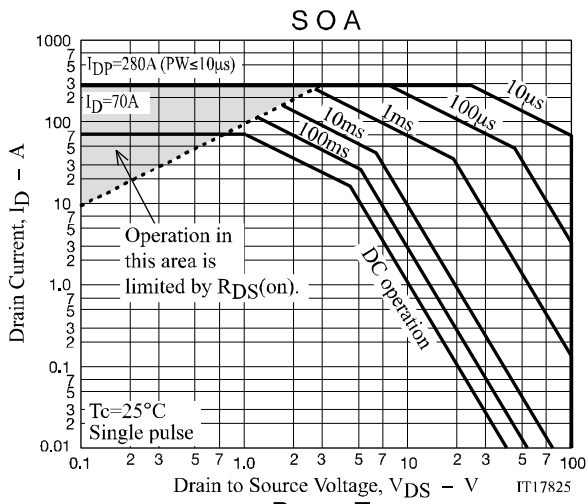

NDPL070N10B

PACKAGE DIMENSIONS

unit : mm

TO-220, 3-Lead / TO-220-3L

CASE 221AU

ISSUE 0

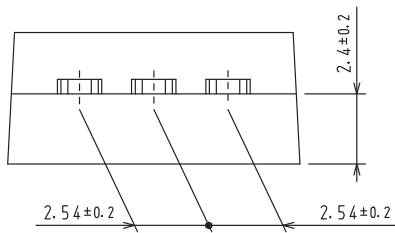
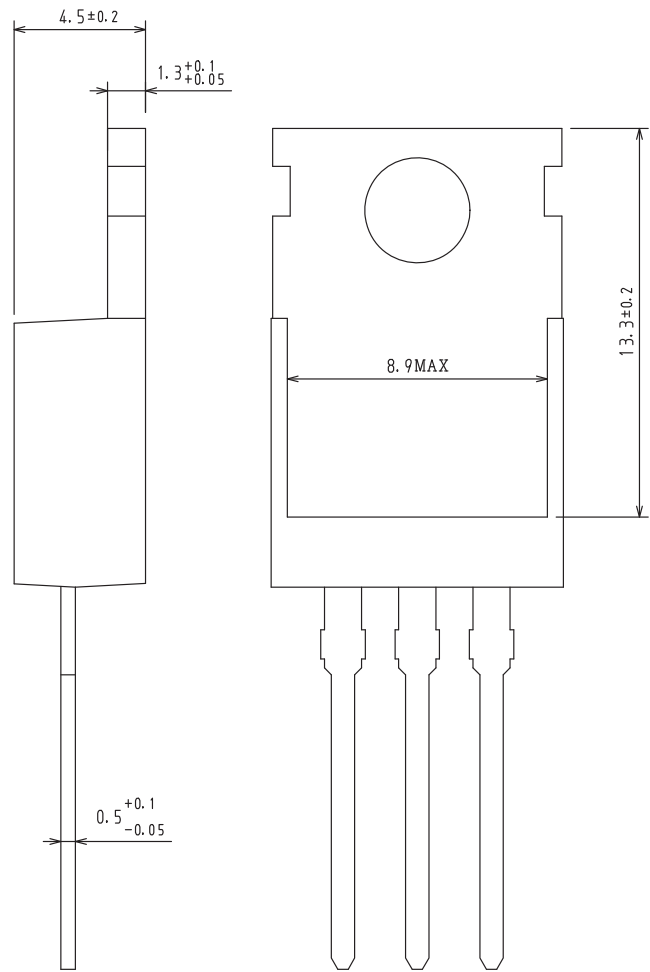
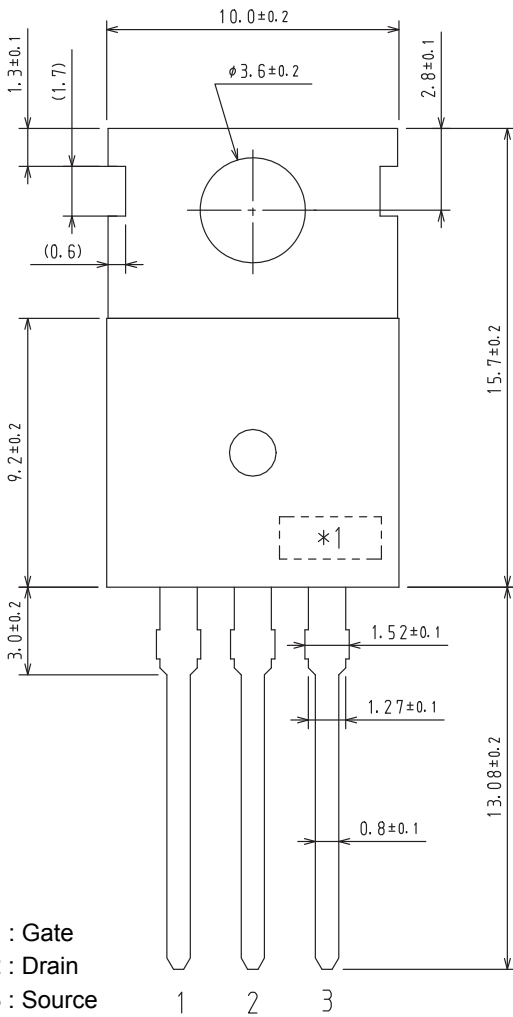

These dimension do not include mold protrusion

*1 : Lot indication

NDPL070N10B

ORDERING INFORMATION

Device	Marking	Package	Shipping (Qty / Packing)
NDPL070N10BG	070N10	TO-220, 3-Lead / TO-220-3L (Pb-Free)	50 / Tube

Note on usage : Since the NDPL070N10B is a MOSFET product, please avoid using this device in the vicinity of highly charged objects.

ON Semiconductor and the ON logo are registered trademarks of Semiconductor Components Industries, LLC (SCILLC) or its subsidiaries in the United States and/or other countries. SCILLC owns the rights to a number of patents, trademarks, copyrights, trade secrets, and other intellectual property. A listing of SCILLC's product/patent coverage may be accessed at www.onsemi.com/site/pdf/Patent-Marking.pdf. SCILLC reserves the right to make changes without further notice to any products herein. SCILLC makes no warranty, representation or guarantee regarding the suitability of its products for any particular purpose, nor does SCILLC assume any liability arising out of the application or use of any product or circuit, and specifically disclaims any and all liability, including without limitation special, consequential or incidental damages. "Typical" parameters which may be provided in SCILLC data sheets and/or specifications can and do vary in different applications and actual performance may vary over time. All operating parameters, including "Typicals" must be validated for each customer application by customer's technical experts. SCILLC does not convey any license under its patent rights nor the rights of others. SCILLC products are not designed, intended, or authorized for use as components in systems intended for surgical implant into the body, or other applications intended to support or sustain life, or for any other application in which the failure of the SCILLC product could create a situation where personal injury or death may occur. Should Buyer purchase or use SCILLC products for any such unintended or unauthorized application, Buyer shall indemnify and hold SCILLC and its officers, employees, subsidiaries, affiliates, and distributors harmless against all claims, costs, damages, and expenses, and reasonable attorney fees arising out of, directly or indirectly, any claim of personal injury or death associated with such unintended or unauthorized use, even if such claim alleges that SCILLC was negligent regarding the design or manufacture of the part. SCILLC is an Equal Opportunity/Affirmative Action Employer. This literature is subject to all applicable copyright laws and is not for resale in any manner.