

FEATURES

- **LOW COST PLASTIC SURFACE MOUNT PACKAGE:**
5.7x5.7x1.1 mm MAX
- **HIGH OUTPUT POWER:**
+32 dBm TYP
- **HIGH LINEAR GAIN:**
10 dB TYP @ 1.8 GHz
- **HIGH POWER ADDED EFFICIENCY:**
45% TYP at 1.8 GHz
- **SINGLE SUPPLY:**
2.8 to 6.0 V

DESCRIPTION

NEC's NE5520279A is an N-Channel silicon power laterally diffused MOSFET specially designed as the power amplifier for mobile and fixed wireless applications. Die are manufactured using NEC's NEWMOS technology (NEC's 0.6 μm WSi gate lateral MOSFET) and housed in a surface mount package.

OUTLINE DIMENSIONS (Units in mm)

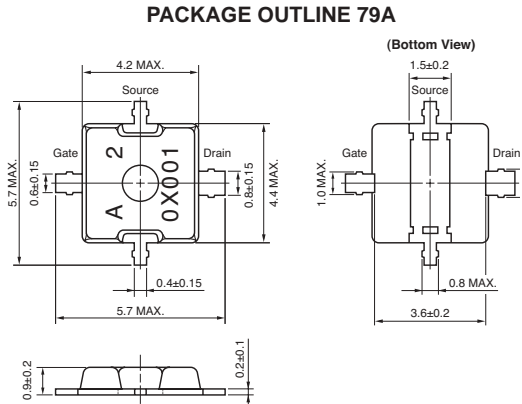

APPLICATIONS

- **DIGITAL CELLULAR PHONES:**
3.2 V DCS1800 Handsets
- **0.7-2.5 GHz FIXED WIRELESS ACCESS**
- **W-LAN**
- **SHORT RANGE WIRELESS**
- **RETAIL BUSINESS RADIO**
- **SPECIAL MOBILE RADIO**

ELECTRICAL CHARACTERISTICS (TA = 25°C)

PART NUMBER PACKAGE OUTLINE				NE5520279A 79A			TEST CONDITIONS
FUNCTIONAL CHARACTERISTICS	SYMBOLS	CHARACTERISTICS	UNITS	MIN	TYP	MAX	
Functional Characteristics	POUT	Output Power	dBm	30.5	32.0		f = 1.8 GHz, VDS = 3.2 V, IDSQ = 700 mA, PIN = 25 dBm, except PIN = 5 dBm for Linear Gain
	GL	Linear Gain	dB		10		
	ηADD	Power Added Efficiency	%	40	45		
	ID	Drain Current	mA		800		
Electrical DC Characteristics	IGSS	Gate-to-Source Leakage Current	nA			100	VGS = 5.0 V
	IDSS	Saturated Drain Current (Zero Gate Voltage Drain Current)	nA			100	VDS = 6.0 V
	VTH	Gate Threshold Voltage	V	1.0	1.4	1.9	VDS = 3.5 V, IDS = 1 mA
	gm	Transconductance	S		1.3		VDS = 3.5 V, IDS = 700 mA
	BVDSS	Drain-to-Source Breakdown Voltage	V	15	18		IDSS = 10 μA
	RTH	Thermal Resistance	°C/W				8 Channel-to-Case

Notes:

1. DC performance is 100% testing. RF performance is testing several samples per wafer.
Wafer rejection criteria for standard devices is 1 reject for several samples.
2. Pin = 5 dBm

ABSOLUTE MAXIMUM RATINGS¹ ($T_A = 25\text{ }^\circ\text{C}$)

SYMBOLS	PARAMETERS	UNITS	RATINGS
V _{DS}	Drain Supply Voltage	V	15.0
V _{GS}	Gate Supply Voltage	V	5.0
I _D	Drain Current	A	0.6
I _D	Drain Current (Pulse Test) ²	A	1.2
P _T	Total Power Dissipation	W	12.5
T _{CH}	Channel Temperature	°C	125
T _{STG}	Storage Temperature	°C	-55 to +125

Note:

1. Operation in excess of any one of these parameters may result in permanent damage.
2. Duty Cycle 50%, Ton = 1 s.

ORDERING INFORMATION

PART NUMBER	QTY
NE5520279A-T1	<ul style="list-style-type: none"> • 12 mm wide embossed taping. • Gate pin faces the perforation side of the tape. • 1 kpcs/Reel

RECOMMENDED OPERATING LIMITS

SYMBOLS	PARAMETERS	UNITS	TYP	MAX
V _{DS}	Drain to Source Voltage	V	3.0	6.0
V _{GS}	Gate Supply Voltage	V	2.0	3.0
I _{DS}	Drain Current ¹	A	0.8	1.0
P _{IN}	Input Power f = 1.8 GHz, V _{DS} = 3.2 V	dBm	25	30

Note:

1. Duty Cycle ≤ 50%, Ton ≤ 1 s.

LARGE SIGNAL IMPEDANCE

(V_{DS} = 3.2 V, I_D = 700 mA, f = 1.8 GHz)

FREQUENCY (GHz)	Z _{in} (Ω)	Z _{OL} (Ω) ¹
1.8	1.77 -j6.71	1.25 -j5.73

Note:

1. Z_{OL} is the conjugate of optimum load impedance at given voltage, idling current, input power.

TYPICAL PERFORMANCE CURVES ($T_A = 25^\circ\text{C}$)

**OUTPUT POWER, DRAIN CURRENT
EFFICIENCY vs. INPUT POWER**

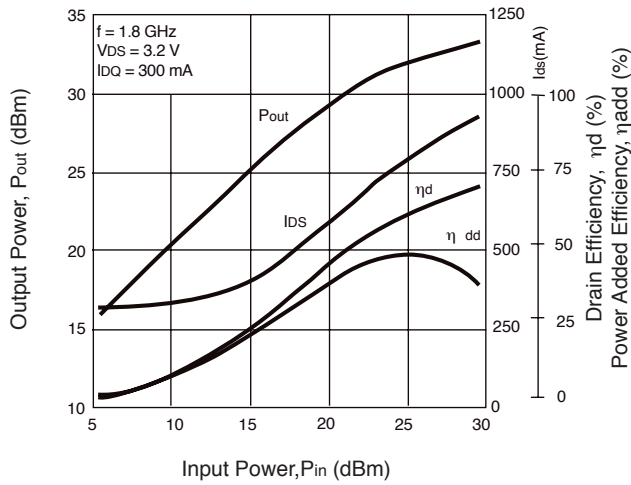

**OUTPUT POWER, DRAIN CURRENT
EFFICIENCY vs. GATE TO SOURCE VOLTAGE**

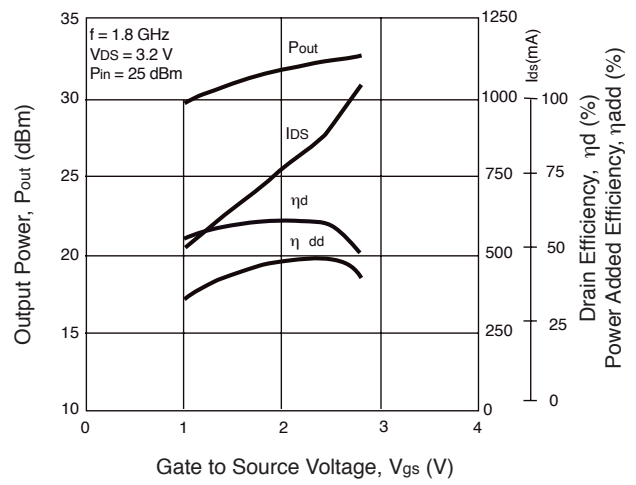

**OUTPUT POWER, DRAIN CURRENT
EFFICIENCY vs. INPUT POWER**

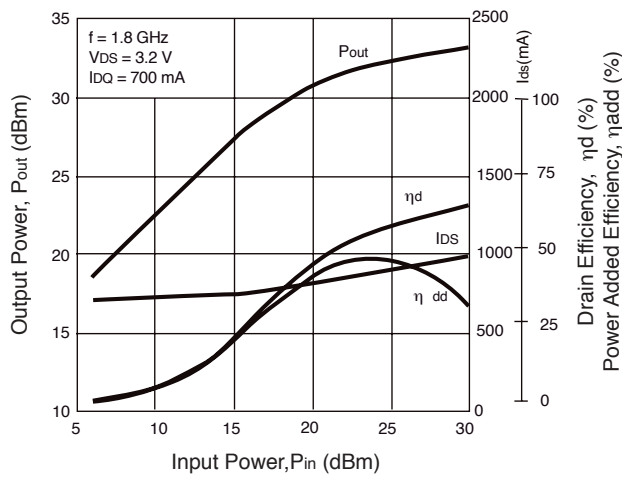

IMD vs. TWO TONE OUTPUT POWER

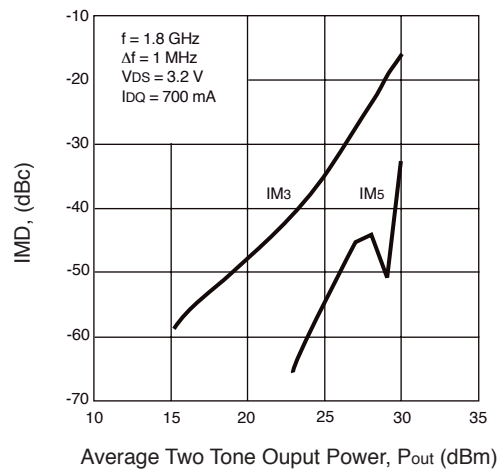

**OUTPUT POWER, DRAIN CURRENT
EFFICIENCY vs. INPUT POWER**

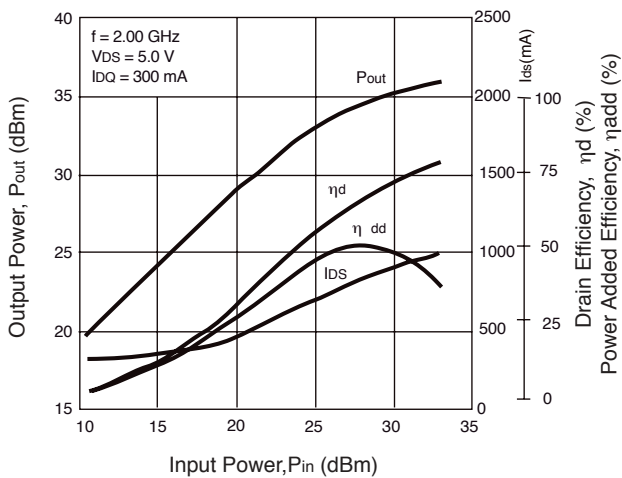

**OUTPUT POWER, DRAIN CURRENT
EFFICIENCY vs. GATE TO SOURCE VOLTAGE**

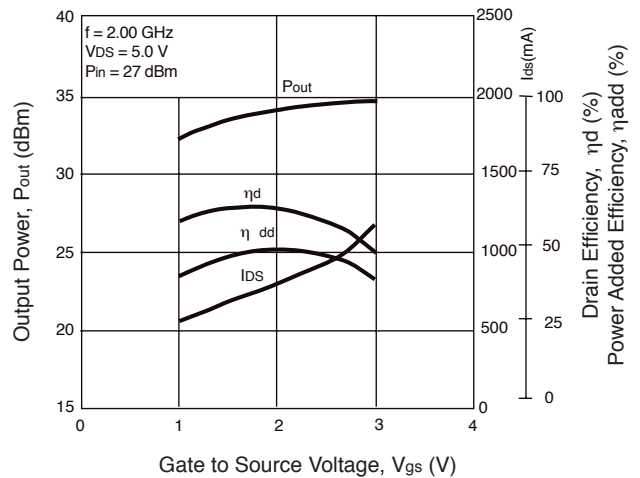

TYPICAL SCATTERING PARAMETERS (TA = 25°C)

Note: This file and many other s-parameter files can be downloaded from www.cel.com

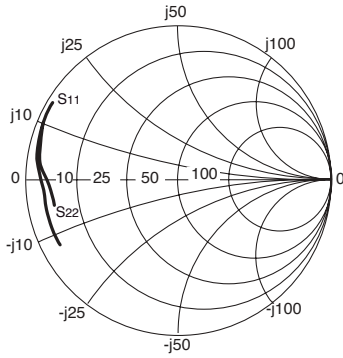

Coordinates in Ohms
Frequency in GHz
VD = 5.0 V, ID = 400 mA

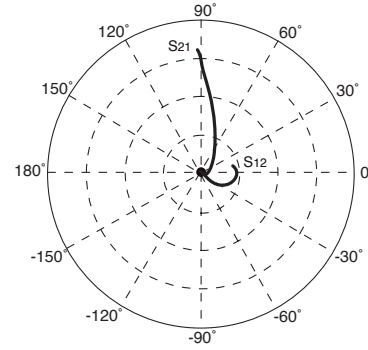

NE5520279A

VD = 5.0 V, ID = 400 mA

FREQUENCY GHz	S11		S21		S12		S22		K	MAG ¹ (dB)
	MAG	ANG	MAG	ANG	MAG	ANG	MAG	ANG		
0.100	0.885	-152.5	11.510	98.5	0.021	10.3	0.830	-170.1	0.03	27.43
0.200	0.885	-166.9	5.882	87.7	0.022	0.2	0.833	-175.4	0.07	24.21
0.300	0.883	-172.4	3.896	80.8	0.022	- 5.2	0.840	-177.5	0.11	22.51
0.400	0.885	-175.6	2.897	75.2	0.021	- 9.2	0.849	-178.5	0.14	21.31
0.500	0.887	-177.9	2.278	70.1	0.021	- 12.9	0.851	-179.3	0.20	20.41
0.600	0.890	-179.8	1.865	65.3	0.020	- 15.7	0.856	179.9	0.27	19.66
0.700	0.895	178.7	1.569	60.7	0.020	- 19.3	0.861	179.1	0.30	19.05
0.800	0.900	177.3	1.346	56.5	0.019	- 21.8	0.869	178.4	0.32	18.55
0.900	0.905	176.0	1.168	52.4	0.018	- 24.5	0.876	177.9	0.36	18.12
1.000	0.911	174.6	1.024	48.5	0.017	- 27.2	0.882	177.2	0.39	17.79
1.100	0.916	173.6	0.911	44.7	0.016	- 28.8	0.894	176.5	0.36	17.48
1.200	0.921	172.2	0.812	40.9	0.015	- 30.8	0.898	175.5	0.42	17.21
1.300	0.924	171.0	0.728	37.5	0.015	- 33.3	0.903	174.7	0.47	16.93
1.400	0.926	169.9	0.655	34.1	0.014	- 33.9	0.907	173.9	0.62	16.84
1.500	0.927	168.7	0.594	30.8	0.013	- 36.0	0.914	172.9	0.68	16.65
1.600	0.929	167.5	0.541	27.9	0.012	- 36.6	0.921	172.2	0.76	16.54
1.700	0.930	166.3	0.494	25.1	0.011	- 37.3	0.925	171.5	0.98	16.58
1.800	0.931	165.2	0.451	22.4	0.010	- 38.5	0.926	170.7	1.22	13.67
1.900	0.935	164.1	0.415	19.6	0.009	- 38.5	0.930	169.8	1.35	12.97
2.000	0.937	162.9	0.384	17.1	0.009	- 38.8	0.937	169.0	1.33	12.95
2.100	0.941	161.8	0.356	14.9	0.008	- 36.9	0.942	168.5	1.45	12.62
2.200	0.944	160.6	0.329	12.6	0.007	- 40.8	0.941	167.8	1.74	11.58
2.300	0.949	159.5	0.305	10.2	0.006	- 36.6	0.942	167.0	2.04	11.01
2.400	0.950	158.3	0.285	7.7	0.006	- 36.0	0.947	166.0	2.04	11.00
2.500	0.955	157.3	0.267	5.8	0.005	- 34.6	0.952	165.5	2.04	11.27
2.600	0.956	156.3	0.248	4.0	0.005	- 32.7	0.953	164.9	2.59	10.34
2.700	0.958	155.4	0.232	2.0	0.004	- 31.4	0.952	164.2	3.32	9.53
2.800	0.957	154.5	0.217	0.0	0.003	- 27.2	0.954	163.2	4.54	8.76
2.900	0.959	153.8	0.204	- 1.6	0.003	- 22.0	0.958	162.4	5.69	8.58
3.000	0.959	152.9	0.192	- 3.1	0.003	- 5.2	0.961	161.9	5.78	8.26
3.100	0.962	152.5	0.180	- 4.5	0.002	- 1.3	0.960	161.1	9.71	7.87
3.200	0.961	151.5	0.170	- 6.1	0.002	27.2	0.960	160.2	9.31	7.08
3.300	0.965	150.8	0.161	- 7.6	0.002	56.3	0.964	159.4	9.54	7.19
3.400	0.967	150.1	0.152	- 8.8	0.002	79.5	0.965	158.6	7.96	6.89
3.500	0.971	149.6	0.144	- 10.0	0.003	86.6	0.963	157.6	5.89	6.46

Note:

1. Gain Calculation:

$$MAG = \frac{|S_{21}|}{|S_{12}|} (K - \sqrt{K^2 - 1})$$

When $K \leq 1$, MAG is undefined and MSG values are used. $MSG = \frac{|S_{21}|}{|S_{12}|}$, $K = \frac{1 + |\Delta|^2 - |S_{11}|^2 - |S_{22}|^2}{2 |S_{12}| |S_{21}|}$, $\Delta = S_{11} S_{22} - S_{21} S_{12}$

MAG = Maximum Available Gain
MSG = Maximum Stable Gain

APPLICATION CIRCUIT (2.40-2.48 GHz)

P.C.B. LAYOUT (Units in mm)

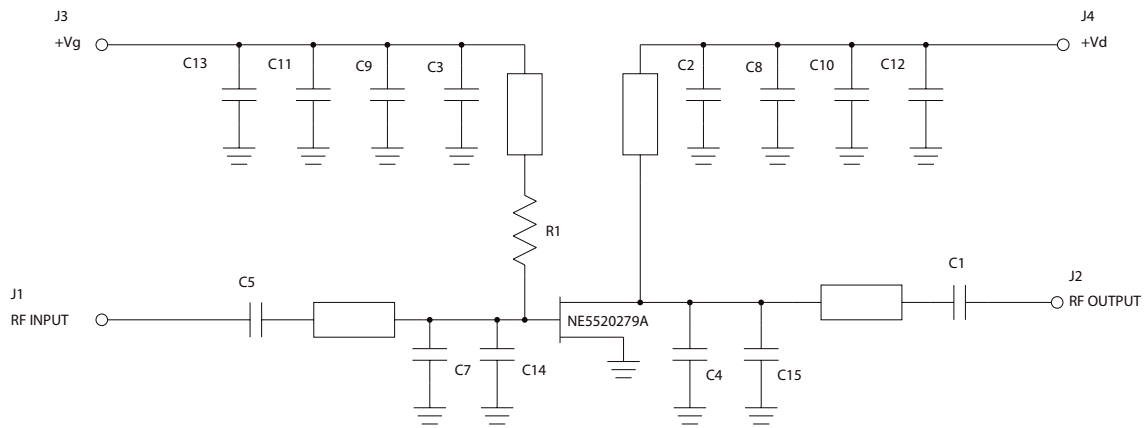
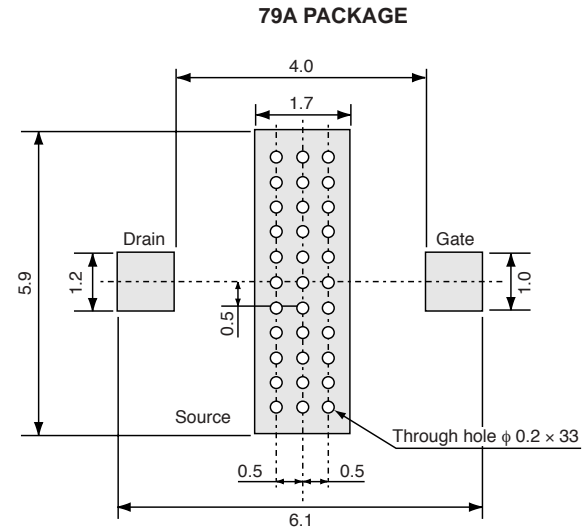
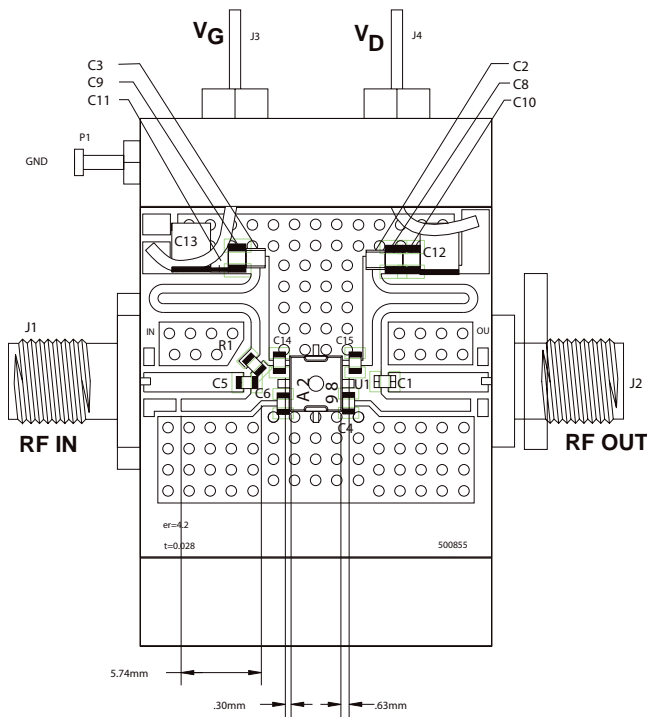

NE5520279A PARTS LIST

1	SD-500881		SCHEMATIC DIAGRAM NE5520279A-EVAL	18
1	TF-100637		TEST CIRCUIT BLK	17
4			2-56 x 3/16 PHILLIPS PAN HEAD	16
2	MA101J	C2,C3	CASE 1 100pF CAP MURATA	15
1	MCR03J200	R1	0603 20 OHM RESISTOR ROHM	14
1	600S2R7CW	C4	0603 2.7pF CAP ATC	13
1	600S2R2BW	C15	0603 2.2pF CAP ATC	12
1	600S1R2BW	C14	0805 1.2pF CAP ATC	11
2	600S5R6CW	C1, C5	0603 5.6pF CAP ATC	10
1	600S3R3CW	C6	0603 3.3pF CAP ATC	9
2	TAJB475K010R	C12, C13	CASE B 4.7 uF CAP AVX	8
2	GRM40X7R104K025BL	C10, C11	0805 .1uF CAP MURATA	7
2	GRM40C0G102J050BD	C8, C9	0805 1000 pF CAP MURATA	6
1	NE5520279A	U1	IC NEC	5
1	703401	P1	GROUND LUG CONCORD	4
1	1250-003	J3, J4	FEEDTHRU MURATA	3
2	2052-5636-02	J1, J2	FLANGE MOUNT JACK RECEPTACLE	2
1	FD-500855B	PCB	S-BAND MODULE FABRICATION DRAWING	1

TYPICAL APPLICATION CIRCUIT PERFORMANCE (TA= 25°C)

OUTPUT POWER vs. INPUT POWER

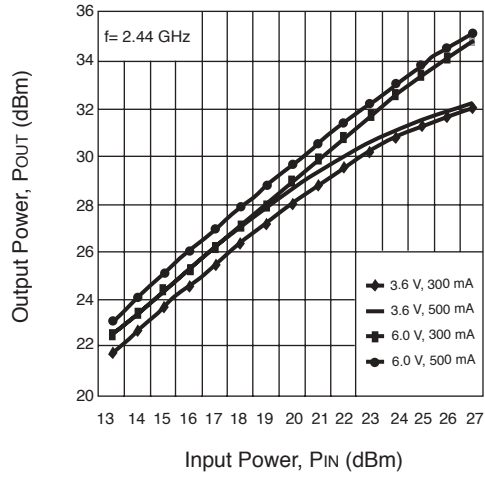

IM3 vs. OUTPUT POWER

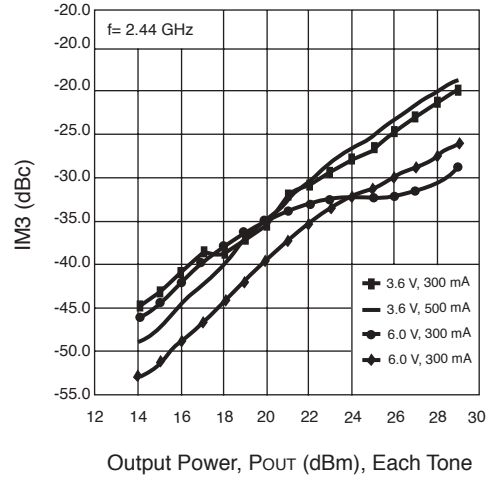

RECOMMENDED SOLDERING CONDITIONS

This product should be soldered and mounted under the following recommended conditions. For soldering methods and conditions other than those recommended below, contact your nearby sales office.

Soldering Method	Soldering Conditions	Condition Symbol
Infrared Reflow	Peak temperature (package surface temperature) : 260°C or below Time at peak temperature : 10 seconds or less Time at temperature of 220°C or higher : 60 seconds or less Preheating time at 120 to 180°C : 120±30 seconds Maximum number of reflow processes : 3 times Maximum chlorine content of rosin flux (% mass) : 0.2%(Wt.) or below	IR260
VPS	Peak temperature (package surface temperature) : 215°C or below Time at temperature of 200°C or higher : 25 to 40 seconds Preheating time at 120 to 150°C : 30 to 60 seconds Maximum number of reflow processes : 3 times Maximum chlorine content of rosin flux (% mass) : 0.2%(Wt.) or below	VP215
Wave Soldering	Peak temperature (molten solder temperature) : 260°C or below Time at peak temperature : 10 seconds or less Preheating temperature (package surface temperature) : 120°C or below Maximum number of flow processes : 1 time Maximum chlorine content of rosin flux (% mass) : 0.2%(Wt.) or below	WS260
Partial Heating	Peak temperature (pin temperature) : 350°C or below Soldering time (per pin of device) : 3 seconds or less Maximum chlorine content of rosin flux (% mass) : 0.2%(Wt.) or below	HS350-P3

Caution Do not use different soldering methods together (except for partial heating).

Life Support Applications

These NEC products are not intended for use in life support devices, appliances, or systems where the malfunction of these products can reasonably be expected to result in personal injury. The customers of CEL using or selling these products for use in such applications do so at their own risk and agree to fully indemnify CEL for all damages resulting from such improper use or sale.

CEL California Eastern Laboratories, Your source for NEC RF, Microwave, Optoelectronic, and Fiber Optic Semiconductor Devices.

4590 Patrick Henry Drive • Santa Clara, CA 95054-1817 • (408) 988-3500 • FAX (408) 988-0279 • www.cel.com

DATA SUBJECT TO CHANGE WITHOUT NOTICE

09/03/2003